

MODEL 203

- 1 Ashtray housing
- 2 Shift lever cover
- 3 Center console

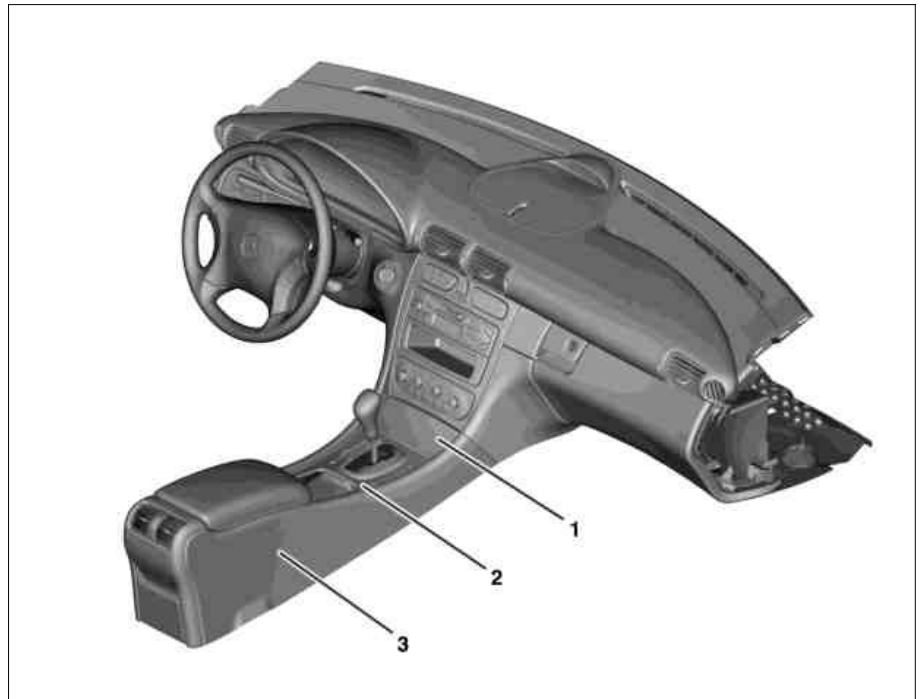

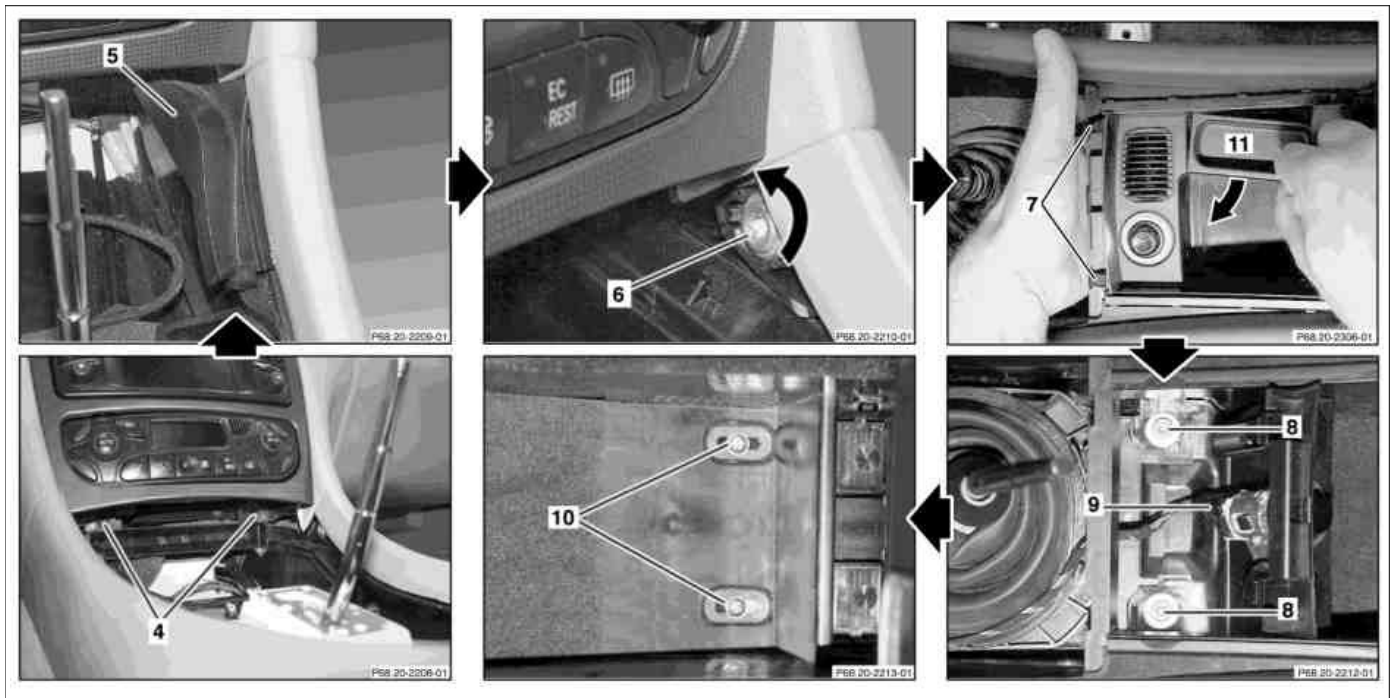



P68.20-2215-06



P68.20-2307-09

- 4 Bolts
- 5 Cover
- 6 Screw
- 7 Catch tabs
- 8 Bolts
- 9 Electrical connector
- 10 Bolts
- 11 Stowage compartment

☒ ☒	Remove/install		
1	Remove ashtray housing (1) at front on center console (3)	i Installation: Check ashtray housing mechanism (1) for proper function, if necessary loosen threaded connection of center console (3) and tighten center console (3) without tension.	AR68.20-P-2400P
2	Remove bolts (4)	i Installation: Ensure that center console (3) is installed without tension.	
3	Unclip left and right cover (5) at front on center console (3)		
4	Turn bolt (6) approx. 1/2 turn in direction of arrow		

5	Open cover on stowage compartment (11)		
6	Remove cup holder		
7	Remove storage compartment (11)	 Lightly press in stowage compartment (11) from outside and pivot out toward side.	
8	Unclip catch tabs (7) and push cigar lighter toward rear		
9	Disconnect electrical connector (9)		
10	Remove bolts (8)	 Replace self-locking bolts (8).  Installation: Ensure that center console (3) is installed without tension.	
11	Unlock center armrest and move to vertical position		
12	Remove carpet insert in stowage compartment.		
13	Remove bolts (10)	 Installation: Ensure that center console (3) is installed without tension.	
14	Remove center console (3) toward rear	 Lift center console (3) at rear.	
15	Reinstall in opposite order		