

ENGINE	271.940 in MODEL 203.042 /242 /742, 209.342 /442
ENGINE	271.941 in MODEL 211.042 /242
ENGINE	271.946 in MODEL 203.046 /246 /746
ENGINE	271.948 in MODEL 203.040 /240 /740
ENGINE	271.942 in MODEL 203.043 /243 /743, 209.343
ENGINE	271.921 in MODEL 203.730
ENGINE	271.955 in MODEL 209.341 /441
ENGINE	271.956 in MODEL 211.041 /241
ENGINE	271.957 in MODEL 203.741

Shown on engine 271.940

- 1 Cylinder head cover
 2 Belt pulley/vibration damper
 3 Camshaft adjuster
 A Guide edge on timing case cover
 B Marking

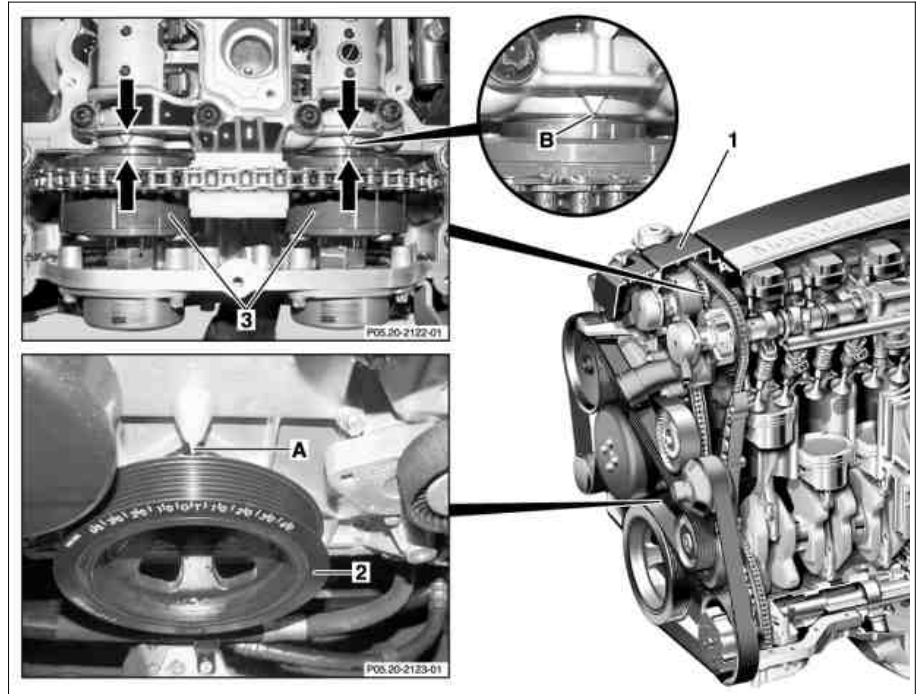

P05.20-2121-06

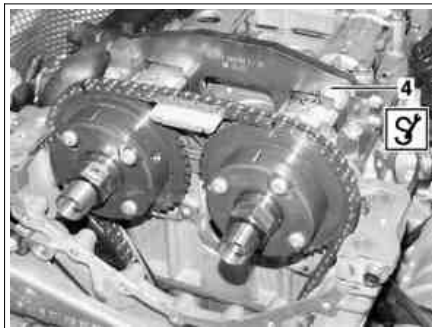

P05.20-2125-01

- 4  Retaining device

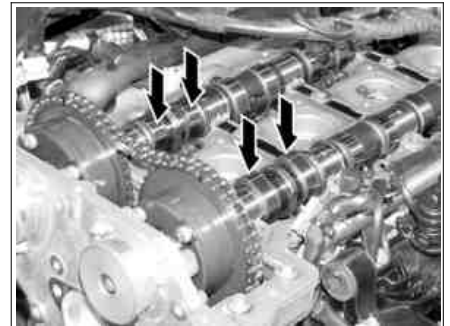















P05.20-2124-01

Modification notes

18.4.05	The timing chain must not be removed from the intake camshaft. The timing chain is slacked only	Step 5	
---------	---	--------	--

	Removing		
1	Open engine hood	Model 203 Model 209 Model 211	AR88.40-P-1000P AR88.40-P-1000Q AR88.40-P-1000T
2	Remove cylinder head cover (1)	Model 203, 209 Model 211	AR01.20-P-5014QK AR01.20-P-5014TK AR01.30-P-5700QK
3	Remove front cover at cylinder head		
4	Spin engine at the crankshaft in direction of rotation until the piston of cylinder 1 is positioned at TDC marking $\pm 2^\circ$	i The TDC marking on belt pulley/vibration damper (2) must be aligned with the positioning edge (A) on timing case cover. i The cams of the inlet and exhaust camshaft at cylinder 1 must be positioned upright at an angle (arrows, picture 2).	
5	Release timing chain		AR05.10-P-7605-01TK

			*271589003100
6	Remove camshaft adjuster (3)	 Secure against falling.	AR05.20-P-7201QK
7	 Mount retainer (4)	 At the same time the camshafts are attached in basic position. 	*271589006100
	Install		
8	Install camshaft adjuster (3)	 The markings on camshaft adjusters (3) must be aligned with markings (B) at camshaft bearing housing (arrows, picture 1). The TDC marking on belt pulley/vibration damper (2) must be aligned with positioning edge (A) on timing case cover.  The camshaft adjusters (3) require no particular adjustment, as they automatically take on a basic position to the camshafts when engine is vertical.	AR05.20-P-7201QK
9	Clamp timing chain	 For this step  Take wedge out of timing case and slacken tensioning rail. 	AR05.10-P-7605-01TK *271589003100
10	 Dismount retainer (4)		*271589006100
11	Rotate crankshaft by two revolutions in direction of rotation of engine and once again check basic position of camshafts	 The markings on the camshaft adjusters (3) must be aligned with the markings (B) at the camshaft bearing housing (arrows, picture 1). The TDC marking on belt pulley/vibration damper (2) must be aligned with positioning edge (A) on timing case cover.	
12	Install front cover at cylinder head		AR01.30-P-5700QK
13	Install cylinder head cover (1)	Models 203, 309 Model 211	AR01.20-P-5014QK AR01.20-P-5014TK
 Danger!	Risk of accident caused by vehicle starting off by itself when engine is running. Risk of injury caused by contusions and burns during starting procedure or when working near the running engine	Secure vehicle to prevent it from moving by itself. Wear closed and snug-fitting work clothes. Do not grasp hot or rotating parts.	AS00.00-Z-0005-01A
14	Check for leaks with engine running		
15	Close engine hood	Model 203 Model 209 Model 211	AR88.40-P-1000P AR88.40-P-1000Q AR88.40-P-1000T

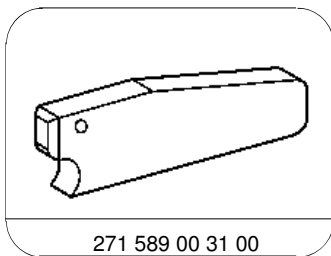

271 589 00 31 00

Wedge

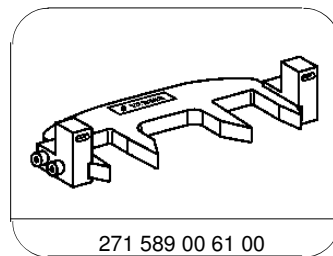

271 589 00 61 00

Retainer