

ENGINE 272, 273 in MODEL 164, 251

ENGINE 273 in MODEL 463

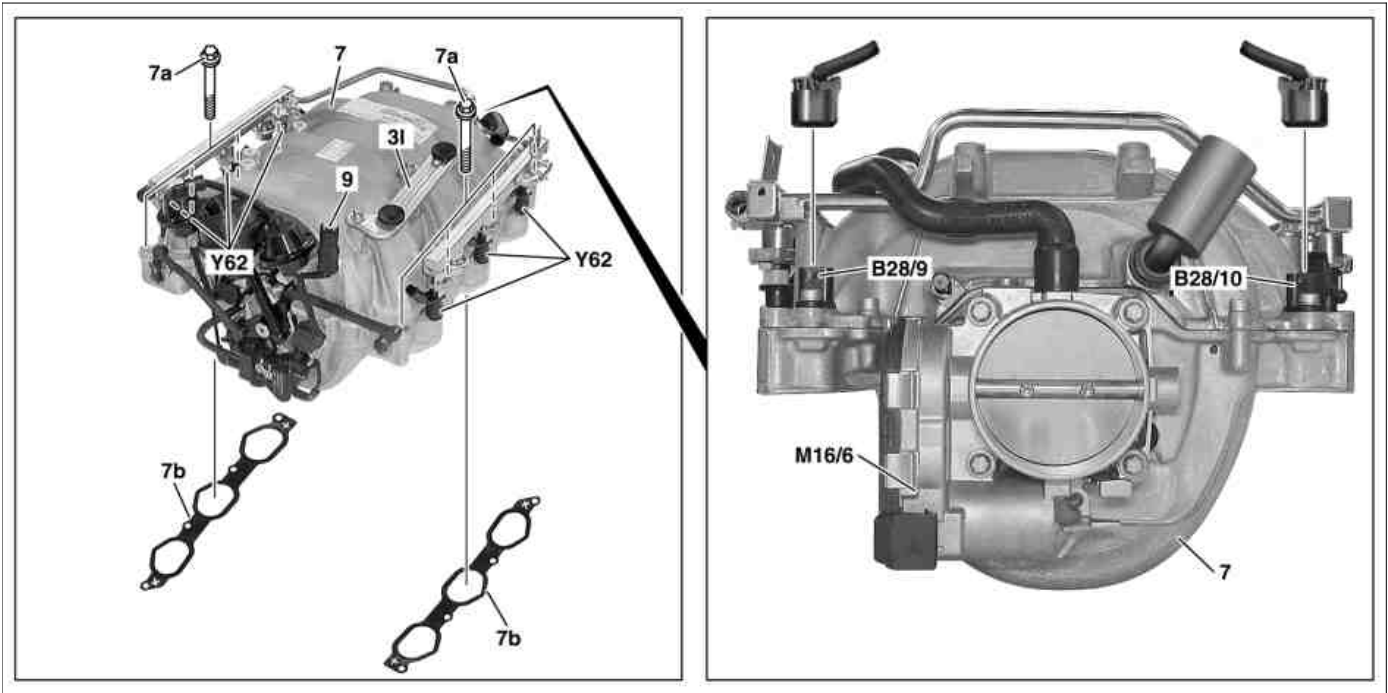

P09.20-2144-09

Shown on engine 272

- 3l Left control unit bracket
- 7 Intake manifold
- 7a Bolt
- 7b Gasket

- 9 Electrical connector
- B28/9 Left intake manifold tumble flap position sensor

- B28/10 Right intake manifold tumble flap position sensor
- M16/6 Throttle valve actuator
- Y62 Fuel injection valves

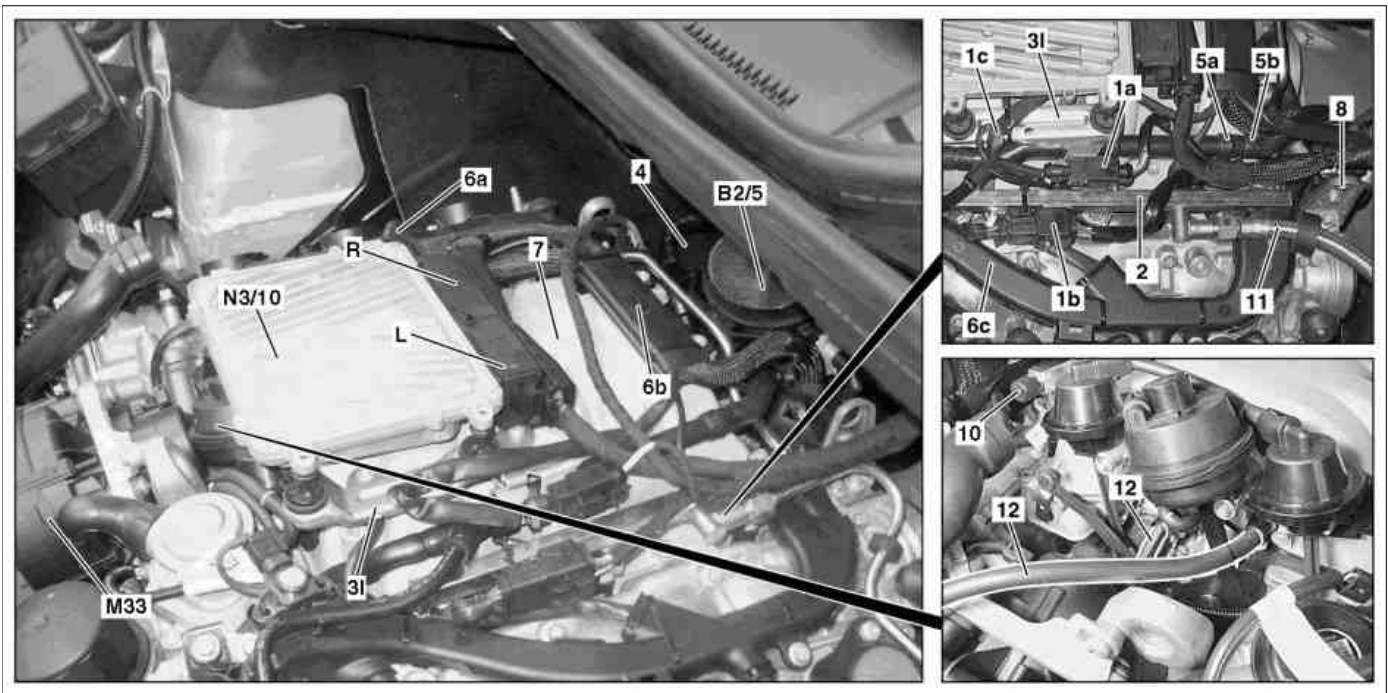

P09.20-2168-09

Shown on engine 272

- 1a Electrical connector
- 1b Electrical connector
- 1c Electrical feed line
- 2 Fuel distributor
- 3l Left control unit bracket
- 4 Air duct housing
- 5a Hose
- 5b Hose











- 6a Feed duct
- 6b Feed duct
- 6c Feed duct
- 7 Intake manifold
- 8 Engine lifting eye
- 10 Service valve
- 11 Fuel pipe
- 12 Pneumatic line

- L Left connector
- R Right connector
- B2/5 Hot film mass air flow sensor
- M33 Electric air pump
- N3/10 ME-SFI [ME] control unit

Modification notes

20.8.09	Remove power electronics with power distributor	Step 1.2	AR08.10-P-0011GZH
---------	---	----------	-------------------

	Remove/install		
Danger!	Risk of explosion caused by fuel igniting, risk of poisoning caused by inhaling and swallowing fuel and risk of injury to eyes and skin caused by contact with fuel	No fire, sparks, open flames or smoking. Only pour fuels into suitable and appropriately marked containers. Wear protective clothing when handling fuel.	AS47.00-Z-0001-01A
	Information on preventing damage to electronic components due to electrostatic discharge		AH54.00-P-0001-01A
1.1	Remove air filter housing	Model 164 (except 164.195), 251 Model 463	AR09.10-P-1150GZA AR09.10-P-1150GZG
1.2	Remove power electronics with power distributor	Model 164.195	AR08.10-P-0011GZH
2	Disconnect right connector (R) at ME-SFI [ME] control unit (N3/10)	Except 164.195	
3	Disconnect electrical connectors (1a, 1b)		
4	Detach jack of electrical connector (1b) on fuel distributor (2)	Installation: Install new cable ties.	
5	Detach electrical feed line (1c) from left control unit bracket (3l)	Installation: Install new cable ties.	
6	Pull ME-SFI [ME] control unit (N3/10) out of left control unit bracket (3) and place to one side	Except 164.195 Do not disconnect left connector (L) at ME-SFI [ME] control unit (N3/10).	
7	Remove hot film mass air flow sensor (B2/5)	Model 164, 251 Model 463	AR07.07-P-1453GZA AR07.07-P-1453GZG
8	Remove air duct housing (4)		AR09.20-P-0080GZA
9	Disconnect hoses (5a, 5b) from crankcase ventilation system		
10	Remove right control unit holder		*BA07.08-P-1002-01A
11	Detach feed duct (6a) from cylinder head cover and intake manifold (7)	 	*BA15.18-P-1001-01B *BA15.18-P-1002-01B
12	Detach feed duct (6b) from intake manifold (7)		*BA15.18-P-1001-01B
13	Remove left rear engine lifting eye (8)	 	*BA01.30-P-1005-01O *BA15.18-P-1003-01B
14	Remove feed duct (6c) from cylinder head cover		*BA15.18-P-1002-01B
15	Release and disconnect the electrical connectors on fuel injection valves (Y62)		
16	Unlock electrical connectors on position sensor for left intake manifold tumble flap (B28/9) and position sensor for right intake manifold tumble flap (B28/10) and disconnect		
17	Disconnect electrical connector (9)		
18	Release and disconnect the electrical connector at the throttle valve actuator (M16/6)		
19	Disconnect electrical connector from electrical air pump (M33)		
20	Reduce fuel pressure with the pressure hose via the service valve (10)	 	AR07.03-P-1460-01GZ *BA07.03-P-1004-01B *119589046300
21	Disconnect fuel line (11) from fuel distributor (2)	Catch escaping fuel with an absorbent rag! Seal connections immediately with stop plugs. 	*BA07.03-P-1001-01B *129589009100
22	Remove bolts (7a)		*BA09.20-P-1001-01N
23	Raise intake manifold (7) at front and detach pneumatic lines (12) from the connection fittings on intake manifold (7)		
24	Take out intake manifold (7)	Installation: Replace seals (7b).	

25	Cover openings in cylinder heads	 Installation: Objects which reach the intake tract must be removed before assembling the intake manifold (7), otherwise engine damage can occur.	
26	Detach left control unit bracket (3l) from intake manifold (7)	 Only when replacing intake manifold (7). 	*BA07.08-P-1002-01A
27	Detach fuel distributor (2) with fuel injection valves (Y62) from intake manifold (7)	 Only when replacing intake manifold (7). 	*BA07.03-P-1002-01B
28	Detach throttle valve actuator (M16/6) from intake manifold (7)	 Only when replacing intake manifold (7). 	*BA07.61-P-1001-01D
29	Detach position sensor for left intake manifold tumble flap (B28/9) and position sensor for right intake manifold tumble flap (B28/10) from intake manifold (7)	 Only when replacing the intake manifold (7). 	*BA09.20-P-1002-01N
30	Install in the reverse order		
	Checking		
 Danger!	Risk of accident caused by vehicle starting off by itself when engine is running. Risk of injury caused by contusions and burns during starting procedure or when working near the engine as it is running	Secure vehicle to prevent it from moving by itself. Wear closed and snug-fitting work clothes. Do not touch hot or rotating parts.	AS00.00-Z-0005-01A
31	Carry out an engine test run and check intake tract and fuel system for leaks		

Control unit

Number	Designation		Engine 272	Engine 273
BA07.08-P-1002-01A	Bolt, control unit bracket to resonance intake manifold	Nm	8	8

Engine wiring harness

Number	Designation		Engine 272	Engine 273
BA15.18-P-1001-01B	Bolt, feed duct to resonance intake manifold	Nm	8	8
BA15.18-P-1002-01B	Bolt, feed duct to cylinder head cover	Nm	8	8
BA15.18-P-1003-01B	Bolt, feed duct to engine lifting eye	Nm	8	8

Cylinder head

Number	Designation		Engine 272	Engine 273
BA01.30-P-1005-01O	Bolt, lifting eye to cylinder head	M8	Nm 20	20

Injectors, injection valves, lines

Number	Designation		Engine 272	Engine 273
--------	-------------	--	------------	------------

BA07.03-P-1001-01B	Union nut, fuel line to fuel distributor	Nm	20	20	
BA07.03-P-1002-01B	Bolt, fuel distributor to resonance intake manifold	Nm	9	9	
BA07.03-P-1004-01B	Protective cap on service valve	Plastic	Nm	2	-
		Metal	Nm	15	-

Nm Intake manifold

Number	Designation		Engine 272	Engine 273
BA09.20-P-1001-01N	Bolt, resonance intake manifold to cylinder head	Nm	9	9
BA09.20-P-1002-01N	Bolt, tumble flap position sensor to resonance intake manifold	Nm	6	6

Nm ME-SFI [ME] gasoline injection and ignition system

Number	Designation		Engine 272	Engine 273
BA07.61-P-1001-01D	Bolt, throttle valve actuator to resonance intake manifold	Nm	9	9

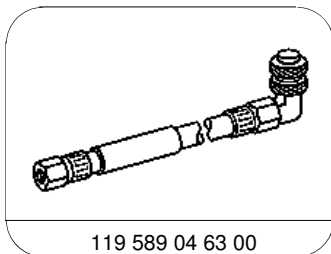

Pressure hose

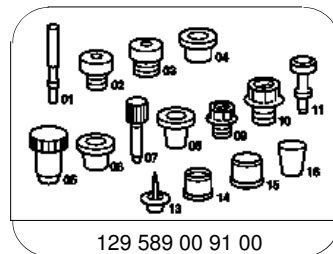

Set of stop plugs