

AR77.21-P-0201NKX Remove/install rear panoramic roof roller sun blind 18.06.2015

Model	156 with code 413 (Automatic panoramic sliding sunroof)
Model	205.0/1/2 with code 413 (Automatic panoramic sliding sunroof)
Model	253 with code 413 (Automatic panoramic sliding sunroof)

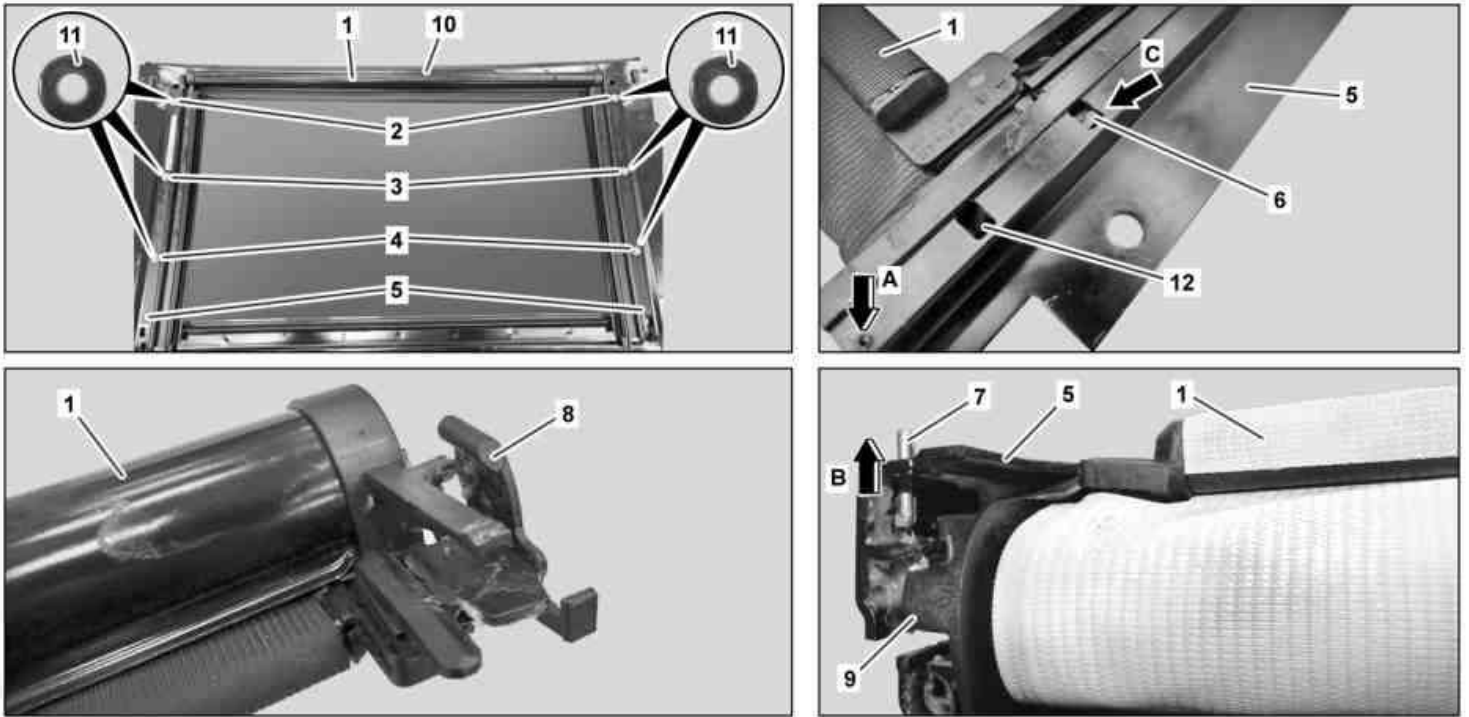











P77.21-2415-09



Shown on model 156

1	Roller sun blind	5	Guide rails	9	Roller blind bearing
2	Bolts	6	Catch hook	10	Panoramic sliding roof frame
3	Bolts	7	Locking pin	11	Shim (MODEL 156)
4	Bolts	8	Driver	12	Cutout

⚠ Danger !	Risk of injury caused by fingers being jammed or pinched when removing, installing or aligning hoods, doors, trunk lid/rear-end door or sliding roof.	No parts of the body or limbs should be within the operating area when the components are moving.	⚠ Risk of injury caused by fingers being jammed or pinched when removing, installing or aligning hoods, doors, trunk lid/rear-end door or sliding roof.
1.1	Remove Detach headliner from roof and lay down in vehicle interior	Model 205.0/1 with code 413 (Automatic panoramic sliding sunroof)	
1.2	Remove headliner and take out from vehicle through opening of liftgate with aid of helper	Model 156 with code 413 (Automatic panoramic sliding sunroof) Model 205.2 with code 413 (Automatic panoramic sliding sunroof) Model 253 with code 413 (Automatic panoramic sliding sunroof)	■ Remove/install headliner

		Model 156 with code 413 (Automatic panoramic sliding sunroof)	 Remove/install headliner
		Model 205.2 with code 413 (Automatic panoramic sliding sunroof) Model 253 with code 413 (Automatic panoramic sliding sunroof)	 Remove/install headliner
2	Remove left and right guide tube for roller sun blind drive cable		 Remove/install guide tube for roller sun blind drive cable
3	Unscrew bolts (2, 4) on left and right side of panoramic sliding roof frame (10)	 Model 156 with code 413 (Automatic panoramic sliding sunroof) Washers (11) are located at the bolts (2, 4) between guide rails (5) and panoramic sliding roof frame (10).	
		 Model 205.0/1/2 with code 413 (Automatic panoramic sliding sunroof) Model 253 with code 413 (Automatic panoramic sliding sunroof) The guide rails (5) are fastened with an additional bolt (4).	
4	Remove bolts (3)	 Model 156 with code 413 (Automatic panoramic sliding sunroof) Washers (11) are located at the bolts (3) between guide rails (5) and panoramic sliding roof frame (10).	
		 Helper required to hold guide rails (5) with roller sun blind (1).	
5	Remove washers (11)	Model 156 with code 413 (Automatic panoramic sliding sunroof)	
		 Helper required to hold guide rails (5) with roller sun blind (1).	
6	Remove guide rails (5) with roller sun blind (1) and remove from vehicle	 Helper required to hold guide rails (5) with roller sun blind (1).	
7	Release catch hooks (6) and slide both roller blind bearings (9) backward until catch hooks (6) engage in rear cutout (arrow C) in left and right guide rail (5)		
8	Remove lockings pins (7) with Ø 2 mm punch from both guide rails (5) in direction of arrow (arrow B)		
9	Release catch hook (6) of left and right roller blind bearing (9) on guide rails (5) and pull left and right roller blind bearing (9) out of guide rails (5)		
	Install		
10	Position roller sun blind (1) with both roller blind bearings (9) on guide rails (5)	 Ensure that drivers (8) are seated correctly in guide rails (5).	
11	Press catch hook (6) down on roller blind bearings (9) and slide both roller blind bearings (9) into guide rails (5) until catch hooks (6) engage in rear cutout (arrow C) in left and right guide rail (5)		
12	Install locking pins (7) in direction of arrow (arrow A) in left and right guide rail (5)	 Installation: The upper end of the locking pins (7) should be flush with the guide rails (5).	

13	Position guide rails (5) with roller sun blind (1) on panoramic sliding roof frame (10)	 Helper required to hold guide rails (5) with roller sun blind (1).	
14	Position washers (11)	Model 156 with code 413 (Automatic panoramic sliding sunroof)  Helper required to hold guide rails (5) with roller sun blind (1).	
15	Screw in bolts (2) on left and right side of panoramic sliding roof frame (10) to stop	 Helper required to hold guide rails (5) with roller sun blind (1).	
		 It should still be possible to move guide rails (5).	
16	Screw in bolts (3, 4) on left and right side of panoramic sliding roof frame (10) to stop	 It should still be possible to move guide rails (5).	
		 Model 205.0/1/2 with code 413 (Automatic panoramic sliding sunroof) Model 253 with code 413 (Automatic panoramic sliding sunroof) The guide rails (5) are fastened with an additional bolt (4).	
17	Tighten bolts (2) with roller sun blind (1) open		
18	Tighten bolts (4) with roller sun blind (1) closed	 Model 205.0/1/2 with code 413 (Automatic panoramic sliding sunroof) Model 253 with code 413 (Automatic panoramic sliding sunroof) The guide rails (5) are fastened with an additional bolt (4).	
19	Tighten bolts (3) with roller sun blind (1) open		
20	Press catch hooks (6) on roller blind bearings (9) down and slide both roller blind bearings (9) forward into guide rails (5) until catch hooks (6) engage in front cutout (12) in left and right guide rail (5)	 The catch hooks (6) should engage fully in the front cutout (12) in the left and right guide rail (5). Otherwise a teach-in run for the automatic reversing panoramic sliding roof reversing function is not possible later.	
21	Manually close roller sun blind (1) and ensure it runs tension-free in the guide rails (5)	 Install guide rails (5) and roller sun blind (1) free of tension. Otherwise noises can occur when the roller sun blind (1) is actuated.	
		If the roller sun blind (1) is under tension when running in the guide rails (5):	
		↓	
		Loosen bolts (2, 3, 4) on left and right guide rail (5), repeat operation steps 16 to 19 and then close roller sun blind (1) again by hand.	
22	Install left and right guide tube for roller sun blind drive cable		 Remove/install guide tube for roller sun blind drive cable
23	Install headliner	Model 156 with code 413 (Automatic panoramic sliding sunroof)	 Remove/install headliner
		Model 205.0/1 with code 413 (Automatic panoramic sliding sunroof)	 Remove/install headliner

		Model 205.2 with code 413 (Automatic panoramic sliding sunroof) Model 253 with code 413 (Automatic panoramic sliding sunroof)	■ Remove/install headliner
24	Normalize panoramic sliding roof with diagnostic system and perform teach-in run for automatic reversing function	Model 156 with code 413 (Automatic panoramic sliding sunroof) Model 205.0/1/2 with code 413 (Automatic panoramic sliding sunroof) Model 253 with code 413 (Automatic panoramic sliding sunroof)	
a		Model 156 with code 413 (Automatic panoramic sliding sunroof)	■ Connect STAR DIAGNOSIS and read out fault memory
a		Model 205.0/1/2 with code 413 (Automatic panoramic sliding sunroof)	■ Connect STAR DIAGNOSIS and read out fault memory