

Parts Information

Parts Information

- Parts list -

Vehicle	C202033 (44W)	C 43 AMG	
Assortment class	PC	Group	47 FUEL SYSTEM
Sub-group	030 FUEL PUMP PACKAGE		

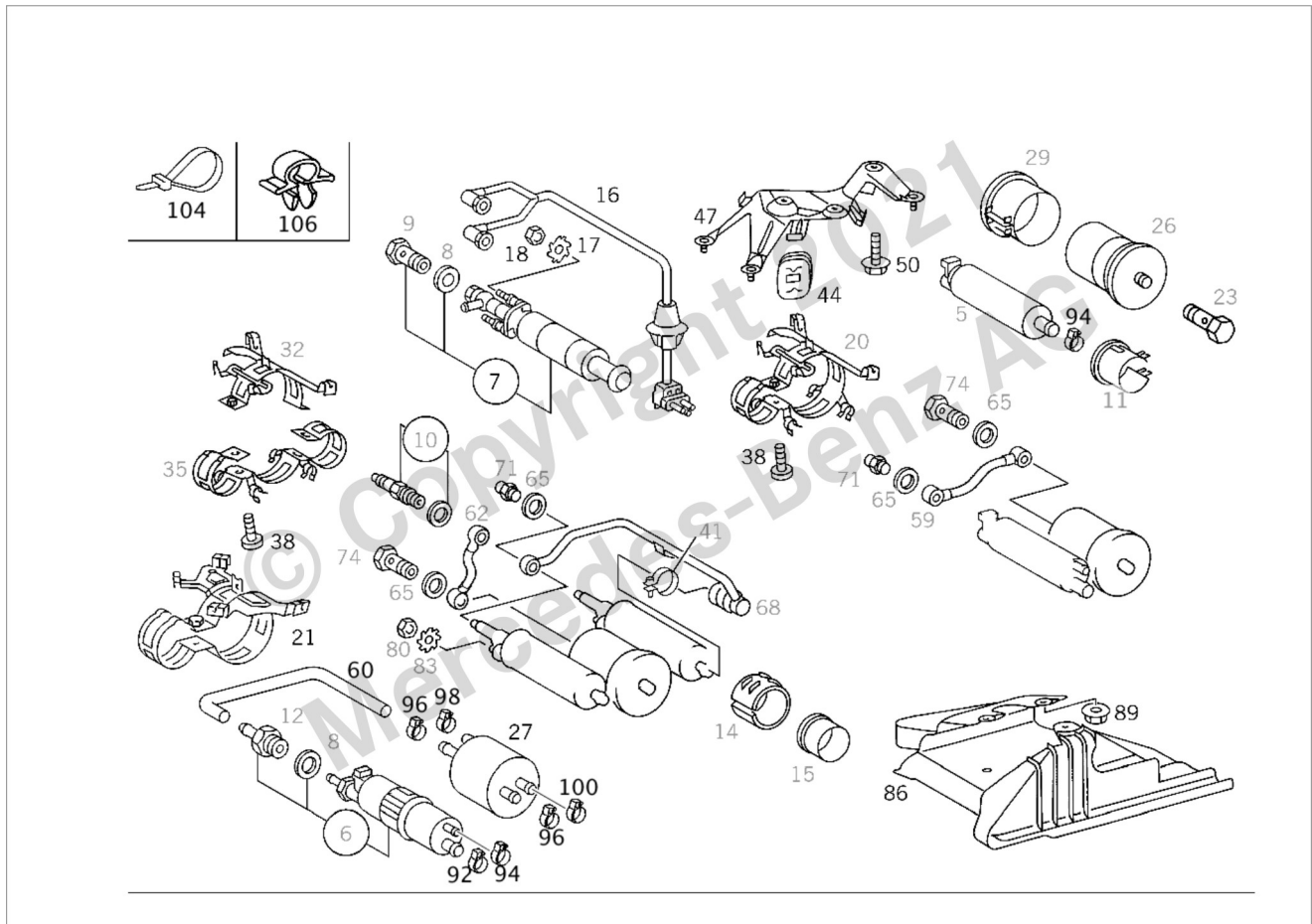















Image ID: drawing_B47030000096

Item	Part number	Designation/additional information	Qty
7	A 000 470 59 94	FUEL PUMP [024, 033] Replaced by: A 000 470 78 94	-
7	A 000 470 78 94 ↕	AUXILIARY PUMP [697] PART IS ONLY OR ALSO SUPPLIED AS RECONDITIONED PART [024, 033] Replaces: A 000 470 59 94	1
16	A 001 546 22 14	ELECTRIC LINE [024, 033]	1
17	N 006797 004134	TOOTH LOCK WASHER M 4 [024, 033]	1
17	N 006797 005131	TOOTH LOCK WASHER M 5 [024, 033]	1

Parts Information

Item	Part number	Designation/additional information	Qty
18	N 304032 004002	HEXAGON NUT M 4  [024, 033]	1
18	N 304032 005005	HEXAGON NUT M 5  [024, 033]	1
21	A 210 471 05 41	BRACKET  [024, 033] Replaced by: A 202 471 13 41	1
21	A 202 471 13 41	BRACKET  [024, 033] Replaces: A 210 471 05 41	1
27	A 002 477 31 01	FUEL FILTER  [029, 033] Replaced by: A 002 477 30 01	-
27	A 002 477 30 01	FUEL FILTER  [029, 033] Replaces: A 002 477 31 01	1
38	N 007985 005532	SCREW M5X25  [022, 023, 024, 029, 033]	1
44	A 124 478 05 82	RUBBER RING	4
47	A 202 478 06 40	BRACKET AT REAR AXLE	1
50	N 914126 006001	SCREW Replaced by: N 910105 006002	-
50	N 910105 006002	HEXAGON HEAD BOLT M6X12 Replaces: N 914126 006001	3
60	A 208 476 22 26	HOSE  [033] Replaced by: A 208 476 21 26	-
60	A 208 476 21 26	HOSE FROM FUEL PUMP TO FILTER  [033] Replaces: A 208 476 22 26	1
86	A 208 478 00 37	PROTECTIVE COVER	1
89	A 003 990 02 51	SCREWED INSERT	3
92	A 006 997 19 90	BINDER FROM FUEL TANK TO FUEL PUMP 21.5 - 22.5 MM; 21.5-22.5 MM	1
94	A 005 997 19 90	CLAMP FROM FUEL TANK TO FUEL PUMP 15.5 - 17.5 MM; 15.5-17.5 MM  [023, 024, 029, 033]	1
96	A 006 997 18 90 	HOSE CLAMP FUEL HOSE TO FILTER 13.0-14.5; 13-14.5 MM  [029, 033]	2
98	A 005 997 19 90	CLAMP RETURN LINE TO FUEL FILTER 15.5 - 17.5 MM; 15.5-17.5 MM  [029, 033]	1

Parts Information

Item	Part number	Designation/additional information	Qty
100	A 006 997 18 90	HOSE CLAMP BREATHER LINE TO FILTER 13.0-14.5; 13-14.5 MM  [029, 033]	1
104	A 001 997 83 90	CABLE TIE 4.6X279 MM	1
106	A 000 995 60 44	CLAMP 6.5X12.8 MM	NB