

Parts Information

Print ✕

Please select the required components for printing.

- Picture chart
- Parts list
 - All parts
 - Marked parts only
- Shopping cart
 - Total basket
 - Current issue only
- Data card
 - Without designation
 - With designation

Parts Information

- Parts list -

Vehicle

C202093 (45H)

C 43 AMG

Assortment class

PC Picture chart

Group

47 FUEL SYSTEM

Sub-group

060 CLOSED FUEL-EVAPORATION-CONTROL SYSTEM

Print ✕

Please select the required components for printing.

Marked parts only

Shopping cart

Total basket

Current issue only

Data card

Cancel Confirm

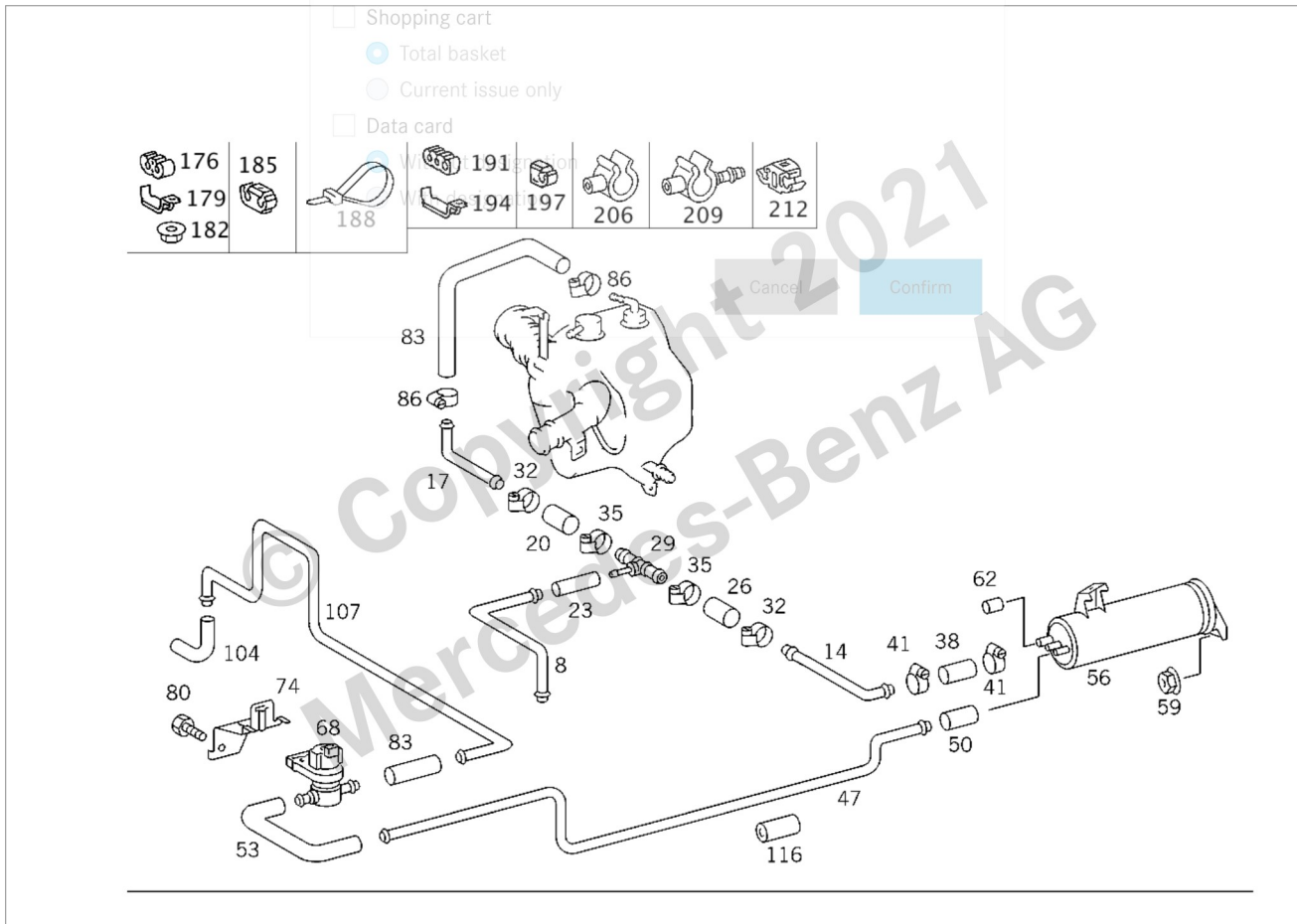















Image ID: drawing_B47060000264

Item	Part number	Designation/additional information	Qty
8	A 202 476 45 01	LINE VENT VALVE TO ACTIVATED CHARCOAL FILTER [081, 086, 087, 088, 089, 093]	1
14	A 202 470 40 64	LINE [081, 086, 087, 088, 089, 093] Replaced by: A 202 476 47 01 +1 A 202 476 46 01 LINE +1 A 202 476 90 26 HOSE +1 A 202 476 99 26 HOSE +1 A 202 476 06 27 HOSE +1 A 000 997 57 74 T-PIECE +2 A 006 997 18 90 HOSE CLAMP +2 A 006 997 19 90 BINDER	-

Parts Information

Item	Part number	Designation/additional information	Qty
14	A 202 476 47 01	<div style="border: 1px solid gray; padding: 5px; width: fit-content; margin-bottom: 5px;"> Print × </div> LINE Please select the required components for printing.  [081, 086, 087, 088, 089, 093] Replaces: A 202 470 40 64 +1 A 202 476 46 01 LINE +1 A 202 476 90 26 HOSE +1 A 202 476 99 26 HOSE +1 A 202 476 06 27 HOSE +1 A 000 997 57 74 T-PIECE +2 A 006 997 18 90 HOSE CLAMP +2 A 006 997 19 90 BINDER	1
17	A 202 476 46 01	LINE Without designation CEXPANSION RESERVOIR TO ACTIVATED CHARCOAL FILTER With designation  [081, 086, 087, 088, 089, 093]	1
20	A 202 476 06 27	HOSE CEXPANSION RESERVOIR TO ACTIVATED CHARCOAL FILTER  [081, 086, 087, 088, 089, 093]	1
23	A 202 476 99 26	HOSE CEXPANSION RESERVOIR TO ACTIVATED CHARCOAL FILTER  [081, 086, 087, 088, 089, 093]	1
26	A 202 476 90 26	HOSE CEXPANSION RESERVOIR TO ACTIVATED CHARCOAL FILTER 45 MM  [081, 086, 087, 088, 089, 093]	1
29	A 000 997 57 74	T-PIECE CEXPANSION RESERVOIR TO ACTIVATED CHARCOAL FILTER  [081, 086, 087, 088, 089, 093]	1
32	A 004 997 24 90	CLAMP CEXPANSION RESERVOIR TO ACTIVATED CHARCOAL FILTER 13 - 14 MM; 13MM  [081, 086, 087, 088, 089, 093] Replaced by: A 006 997 18 90	2
32	A 006 997 18 90	HOSE CLAMP CEXPANSION RESERVOIR TO ACTIVATED CHARCOAL FILTER 13 - 14 MM; 13-14.5 MM  [081, 086, 087, 088, 089, 093] Replaces: A 004 997 24 90	2
35	A 001 997 69 90	HOSE CLAMP CEXPANSION RESERVOIR TO ACTIVATED CHARCOAL FILTER 13 X 9 MM; 9-13 MM  [081, 086, 087, 088, 089, 093]	2
38	A 114 997 18 82	HOSE 13.3X3 MM  [404] ORDER BY THE METER  [078, 080, 081, 082, 083, 085, 086, 087, 088, 089, 093] Replaced by: N 916030 000527 Replaced by: A 230 476 87 26	-
38	N 916030 000527	HOSE VENT LINE CONNECTION ON ACTIVATED CHARCOAL FILTER 115 MM; 7.5X3  [404] ORDER BY THE METER  [078, 080, 081, 082, 083, 085, 086, 087, 088, 089, 093] Replaced by: A 230 476 87 26 Replaces: A 114 997 18 82	1

Parts Information

Item	Part number	Designation/additional information	Qty
38	A 230 476 87 26	HOSE VENT LINE CONNECTION ON ACTIVATED CHARCOAL FILTER 115 MM; 7,3 X 3 MM [404] ORDER BY THE METER [078, 080, 081, 082, 083, 085, 086, 087, 088, 089, 093] Replaces: N 916030 000527 Replaces: A 114 997 18 82	1
41	A 001 997 69 90	HOSE CLAMP 13 X 9 MM; 9-13 MM	NB
47	A 202 471 19 15	VENT TUBE [086, 088, 089, 093]	1
50	A 107 476 37 26	HOSE FROM ACTIVATED CHARCOAL FILTER TO BREATHER LINE 180 MM [404] ORDER BY THE METER [078, 080, 081, 082, 083, 085, 086, 087, 088, 089, 093]	1
53	A 202 476 11 26	HOSE BETWEEN BREATHER VALVE AND PURGE VALVE [078, 080, 081, 082, 083, 085, 086, 087, 088, 089, 093]	1
56	A 202 470 09 59	ACTIVATED CHARCOAL FILTER [078, 080, 082, 083, 085, 086, 089, 093]	1
56	A 202 470 12 59	ACTIVATED CHARCOAL FILTER [078, 080, 081, 082, 083, 085, 086, 087, 088, 089, 093]	1
59	A 003 990 02 51	SCREWED INSERT ACTIVATED CHARCOAL FILTE ON BODYWORK [078, 080, 081, 082, 083, 085, 086, 087, 088, 089, 093]	3
62	A 107 476 00 78	PROTECTIVE CAP FRESH AIR CONNECTION [078, 080, 081, 082, 083, 085, 086, 087, 088, 089, 093]	1
68	A 000 470 15 93	PURGE VALVE [086, 088, 089, 093] Replaced by: A 000 470 35 93	-
68	A 000 470 35 93	PURGE VALVE [086, 088, 089, 093] Replaces: A 000 470 15 93	1
74	A 202 476 13 36	BRACKET REGENERATION VALVE [402] NO LONGER AVAILABLE [078, 080, 081, 082, 083, 085, 086, 087, 088, 089, 093]	1
80	A 202 990 03 17	THD. ROLLING, HEAD BOLT REGENERATION VALVE; M6X19 [078, 080, 081, 082, 083, 085, 086, 087, 088, 089, 093]	1
83	A 202 476 65 26	HOSE REGENERATION VALVE TO THROTTLE HOUSING 80 MM; 15.3X3 MM [404] ORDER BY THE METER [085, 086, 089, 093]	1
86	A 003 997 90 90	HOSE CLAMP EXPANSION TANK	2
104	A 111 078 01 81	HOSE REGENERATION VALVE TO THROTTLE HOUSING [086, 088, 089, 093]	1
107	A 202 471 18 15	VENT TUBE REGENERATION VALVE TO THROTTLE HOUSING [086, 089, 093]	1

Parts Information

Item	Part number	Designation/additional information	Qty
116	A 230 476 87 26	HOSE BREATHER LINE TO SIDE MEMBER,FRONT 30 MM; 7,3 X 3 MM [404] ORDER BY THE METER [078, 080, 081, 082, 085, 086, 087, 089, 093, 182, 188]	1
176	A 140 328 09 88	DAMPING STRIP DE-AERATION LINE [078, 080, 081, 082, 083, 085, 086, 087, 088, 089, 093]	1
179	A 140 995 03 22	CLAMP DE-AERATION LINE 29 X 22 MM [078, 080, 081, 082, 083, 085, 086, 087, 088, 089, 093]	1
182	A 003 990 02 51	SCREWED INSERT DE-AERATION LINE [078, 080, 081, 082, 083, 085, 086, 087, 088, 089, 093]	3
185	A 652 476 11 36	BRACKET AERATION/VENTILATION [078, 080, 081, 082, 083, 085, 086, 087, 088, 089, 093]	1
191	A 202 476 05 84	DAMPING STRIP DE-AERATION LINE	2
194	A 110 995 00 22	CLAMP DE-AERATION LINE 38 X 21 MM	2
197	A 000 995 74 65	CLAMP DE-AERATION LINE 8 X 15 MM; 5 MM Replaced by: A 000 995 05 77	2
197	A 000 995 05 77	LINE FASTENER DE-AERATION LINE 8 X 15 MM Replaces: A 000 995 74 65	2
197	A 000 995 74 65	CLAMP 5 MM Replaced by: A 000 995 05 77	-
197	A 000 995 05 77	LINE FASTENER REGENERATION LINE 8 X 15 MM Replaces: A 000 995 74 65	NB
197	A 129 995 00 65	CLAMP FUEL LINES TO VEHICLE FLOOR 3,2 X 12 MM [086, 088, 089, 093]	2
206	A 123 995 00 65	CLAMP REGENERATION LINE 8 - 9 MM [086, 088, 089, 093]	1
209	A 000 476 04 36	HOSE BRACKET REGENERATION LINE 11 - 13 X 10 MM [086, 088, 089, 093]	1
212	A 129 995 02 65	CLAMP BREATHER LINE TO WHEEL ARCH 8 / 3,2 X 12 MM [088, 089, 093]	1