

- MODEL 204**
MODEL 207.3
 as of model year 2014
 without CODE 427 (7-speed automatic transmission)
- MODEL 207.3**
 up to model year 2014
- MODEL 212.0** (except 212.074/077), 212.1, 212.2 (except 212.274/277)
 without CODE 279 (Electronic gear selector)
- MODEL 212.074/077/274/277**

Shown on center console (1) on MODEL 204.0 up to 28.02.2011 with CODE 386 (Comfort telephony)

- 1 Center console
 3 Cover
 5 Stowage box/tray (without CODE 301 (Ashtray package/smoker package))
 6 Armrest
 7 Waste receptacle
 11 Cover
 13 Roller blind (on model 204.0/2/3, 207.3, 212)
 18 Cover (without CODE 301 (Ashtray package/smoker package))
 20 Rear air vent
 24 Mounting console (on MODEL 204.0/2/3, 207.3, 212 with CODE 386 (Comfort telephony))
 A34/7 Bluetooth module (with CODE (386) (Comfort telephony))
 A40/9 Audio/COMAND control panel

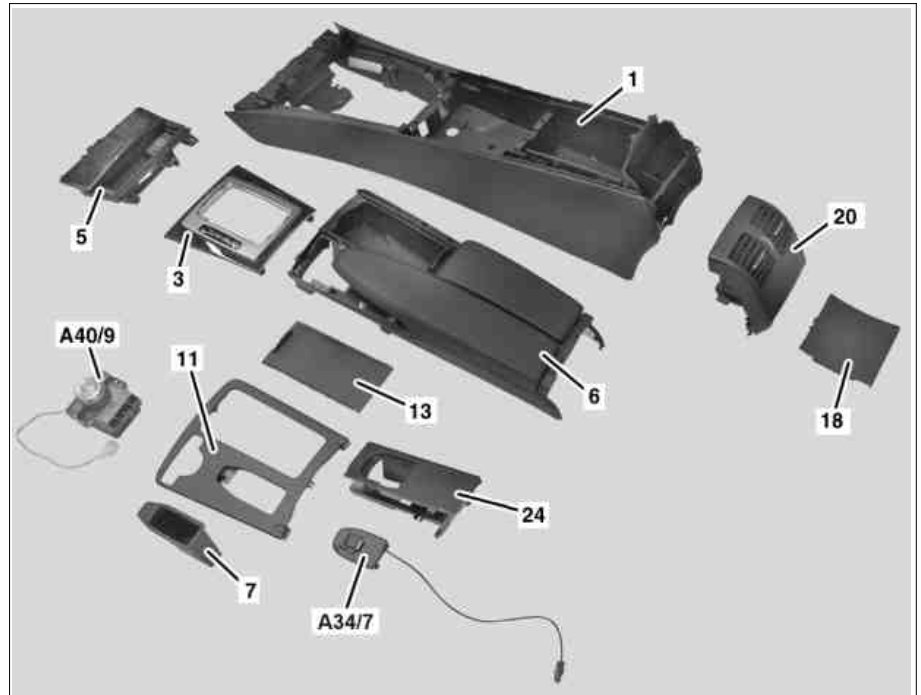

P68.20-4126-06

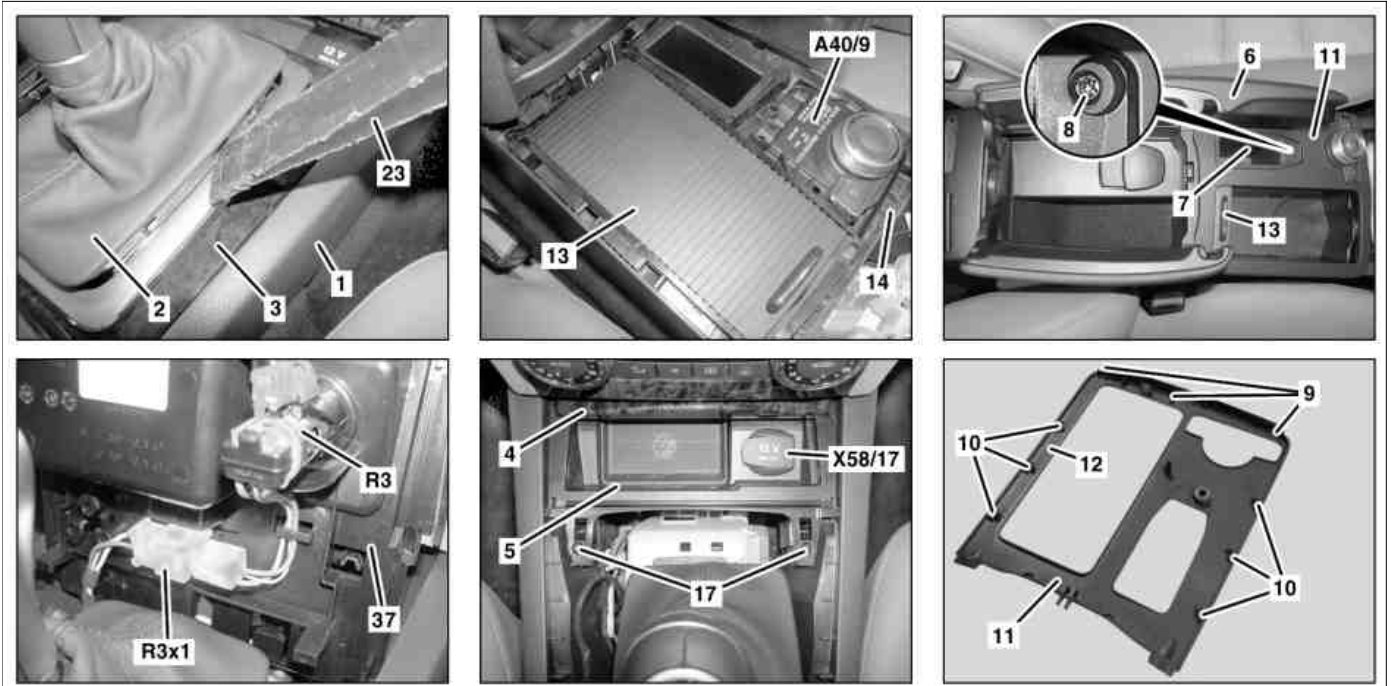

P68.20-3704-09

Shown on center console (1) on MODEL 204.0 with CODE 386 (Comfort telephony)

- 1 Center console
 12 Web

2	Boot	13	Roller blind (on model 204.0/2/3, 207.3, 212)
3	Cover	14	Screw
4	Cover	17	Bolts
5	Stowage box/tray (without CODE 301 (Ashtray package/smoker package))	23	Assembly wedge
6	Armrest	37	Front ashtray (with CODE 301 (Ashtray package/smoker package))
7	Waste receptacle	A40/9	Audio/COMAND control panel
8	Screw	R3	Cigarette lighter with front ashtray illumination (with code 301 (Ashtray package/smoker package))
9	Front catch hook	R3x1	Electrical connector for front cigarette lighter with ashtray illumination (with code 301 (Ashtray package/smoker package))
10	Side catch hook	X58/17	Front vehicle interior socket (without code 301 (Ashtray package/smoker package))
11	Cover		

Shown on model 204.0

- 1 Center console
- 15 Electrical connector
- 16 Electrical connector
- 34 Electrical line

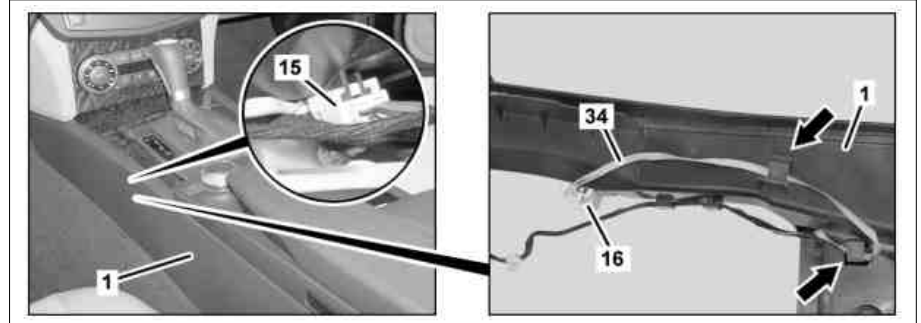

P68.20-3795-04

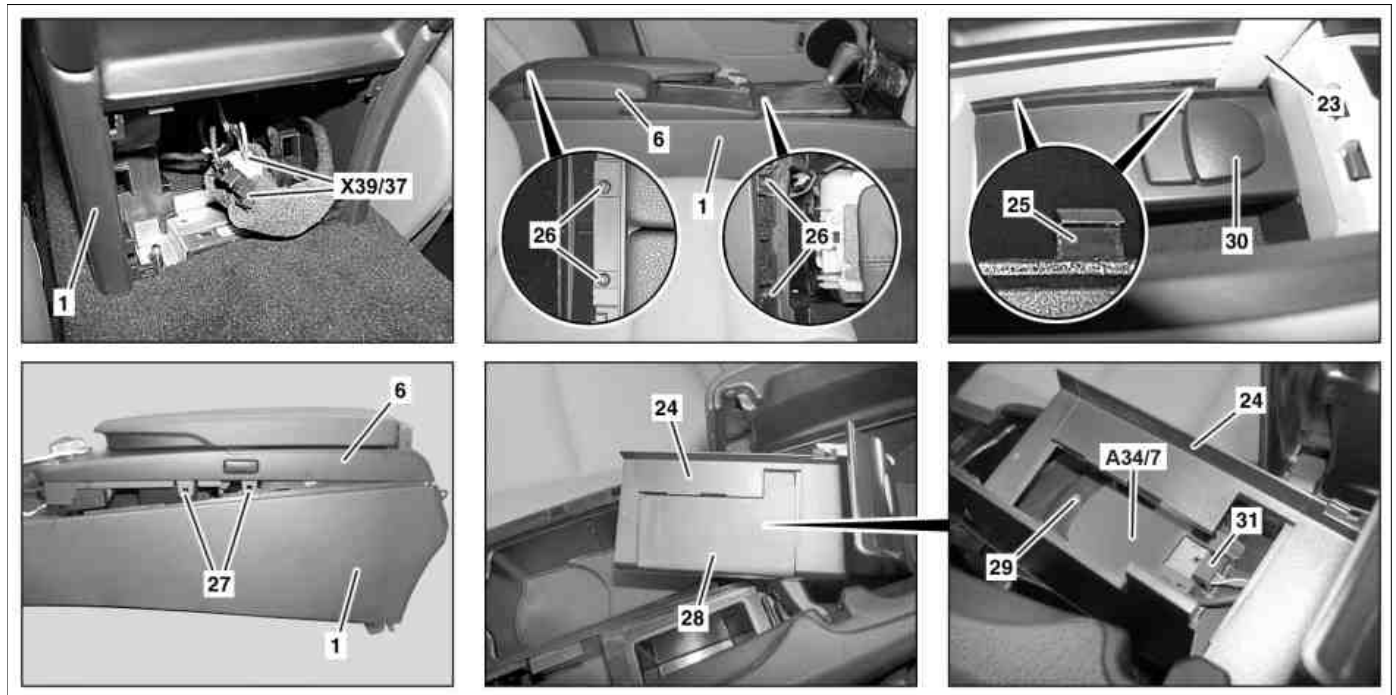

P68.20-4127-09

Shown on MODEL 204.0 up to 28.02.2011 with CODE 386 (Comfort telephony)

1	Center console	26	Bolts	31	Electrical connector (on MODEL 204.0/2, 207.3 up to 28.02.2011, 212 with CODE 386 (Comfort telephony))
6	Armrest	27	Lugs	A34/7	Bluetooth module (with CODE 386 (Comfort telephony))
23	Assembly wedge	28	Flap (on MODEL 204.0/2, 207.3 up to 28.02.2011, 212 with CODE 386 (Comfort telephony))	X39/37	Electrical connector for mobile phone (with CODE 386 (Comfort telephony))
24	Mounting console (on MODEL 204.0/2, 207.3 up to 28.02.2011, 212 with CODE 386 (Comfort telephony))	29	Bolt (on MODEL 204.0/2, 207.3 up to 28.02.2011, 212 with CODE 386 (Comfort telephony))		

- 25 Catch hook (on MODEL 204.0/2/3, 30 Cover (on MODEL 204.0/2, 207.3, 207.3, 212 with CODE 386 (Comfort telephony))
- 30 Cover (on MODEL 204.0/2, 207.3, 212 with CODE 386 (Comfort telephony))

Shown on MODEL 207.3 as of 01.03.2011 with CODE 386 Comfort telephony and CODE 512 (COMAND APS incl. DVD changer)

- X39/37 Electrical connectors for mobile phone (with CODE 386 (Comfort telephony))
- X115x1 Separation point for electrical connector USB (on MODEL 204 with CODE 512 (COMAND APS incl. DVD changer), MODEL 207.3 as of 01.07.11 up to model year 2014 with CODE 512 (COMAND APS incl. DVD changer) or CODE 526 (COMAND (without navigation)) or CODE 528 (COMAND incl. DVD changer) or CODE 527 (COMAND APS with single DVD drive (with navigation)), MODEL 207.3 as of 01.06.12 up to model year 2014 with CODE 510 (Audio 20 CD with CD changer) or CODE 523 (Radio MB Audio 20), MODEL 207.3 as of model year 2014)

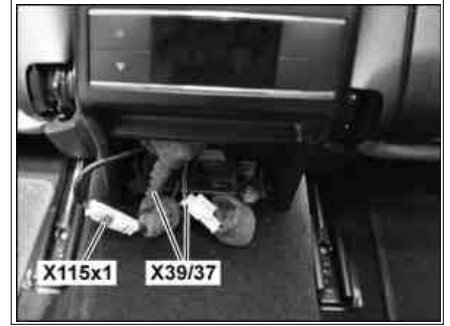

P82.70-7617-01

Shown on mounting console (36) on MODEL 204.9 with CODE 386 (Comfort telephony)

- 35 Bolt (with CODE 386 (Comfort telephony))
- 36 Mounting console (with CODE 386 (Comfort telephony))
- 38 Electrical connector (on MODEL 204.9 with CODE 386 (Comfort telephony))
- A34/7 Bluetooth module (with CODE 386 (Comfort telephony))

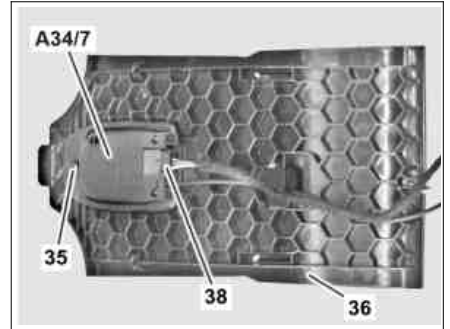

P68.20-4128-01

Shown on mounting console (39) on MODEL 207 with CODE 386 (Comfort telephony)

- 1 Center console
- 22 Electrical line
- 23 Assembly wedge
- 25 Catch hook (on MODEL 204.0/2/3, 207.3, 212 with CODE 386 (Comfort telephony))
- 39 Mounting console (on MODEL 204.0/2, 207.3 as of 01.03.2011, MODEL 204.3 with CODE 386 (Comfort telephony))
- 40 Bolt (MODEL 204.0/2 as of 01.03.11, 204.3 with CODE 386 (Comfort telephony) or CODE 512 (COMAND APS incl. DVD changer) or CODE 518 (Media Interface), MODEL 207.3 as of 01.03.11 up to model year 2014 with CODE 386 (Comfort telephony) or CODE 512 (COMAND APS incl. DVD changer) or CODE 518 (Media Interface), MODEL 207.3 as of model year 2014 with CODE 386 (Comfort telephony))
- A34/7 Bluetooth module (with CODE 386 (Comfort telephony))

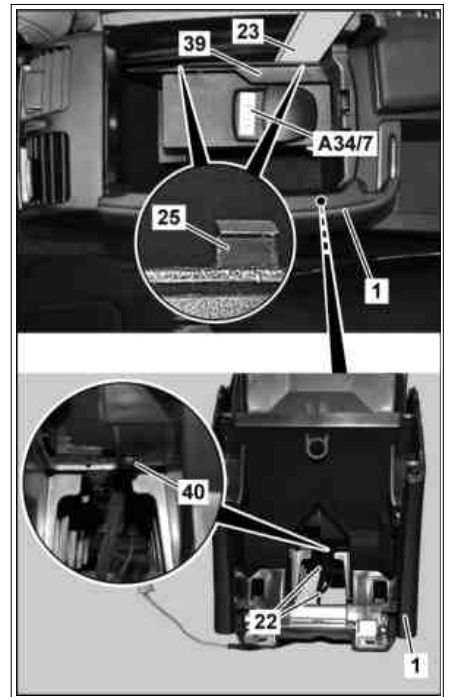

P82.70-7615-03

12	Disconnect electrical connector (15)	Only when removing audio/COMAND operating unit (A40/9) completely.	
13	Unclip electrical connector (16) from center console (1), unhook electrical line (34) from guides (arrows) and remove Audio/COMAND control unit (A40/9)	Only when removing audio/COMAND operating unit (A40/9) completely.	
14.1	Unscrew bolts (17) and remove stowage box (5) until electrical connector on front vehicle interior socket (X58/17) is accessible	MODEL 204 without CODE 301 (Ashtray package/smoker package) MODEL 207.3 as of model year 2014 without CODE 301 (Ashtray package/smoker package) without CODE 427 (7-speed automatic transmission) MODEL 207.3 up to model year 2014 without CODE 301 (Ashtray package/smoker package) MODEL 212.0 (except 212.074/077), 212.1, 212.2 (except 212.274/277) without CODE 279 (Electronic gear selector) without CODE 301 (Ashtray package/smoker package) MODEL 212.074/077/274/277 without CODE 301 (Ashtray package/smoker package)	
14.2	Unscrew bolts (17) and remove ashtray (37) until electrical connector on the cigarette lighter with front ashtray illumination (R3x1) is accessible	MODEL 204 with CODE 301 (Ashtray package/smoker package) MODEL 207.3 as of model year 2014 with CODE 301 (Ashtray package/smoker package) without CODE 427 (7-speed automatic transmission) MODEL 207.3 up to model year 2014 with CODE 301 (Ashtray package/smoker package) MODEL 212.0 (except 212.074/077), 212.1, 212.2 (except 212.274/277) with CODE 301 (Ashtray package/smoker package) without CODE 279 (Electronic gear selector) MODEL 212.074/077/274/277 with CODE 301 (Ashtray package/smoker package)	
15.1	Disconnect electrical connector from front vehicle interior socket (X5817) and remove stowage box (5)	MODEL 204 without CODE 301 (Ashtray package/smoker package) MODEL 207.3 as of model year 2014 without CODE 301 (Ashtray package/smoker package) without CODE 427 (7-speed automatic transmission) MODEL 207.3 up to model year 2014 without CODE 301 (Ashtray package/smoker package) MODEL 212.0 (except 212.074/077), 212.1, 212.2 (except 212.274/277) without CODE 279 (Electronic gear selector) without CODE 301 (Ashtray package/smoker package) MODEL 212.074/077/274/277 without CODE 301 (Ashtray package/smoker package)	

15.2	Disconnect electrical connector on cigarette lighter with front ashtray illumination (R3x1) from cigarette lighter with front ashtray illumination (R3) and remove front ashtray (37)	MODEL 204 with CODE 301 (Ashtray package/smoker package) MODEL 207.3 as of model year 2014 with CODE 301 (Ashtray package/smoker package) without CODE 427 (7-speed automatic transmission) MODEL 207.3 up to model year 2014 with CODE 301 (Ashtray package/smoker package) MODEL 212.0 (except 212.074/077), 212.1, 212.2 (except 212.274/277) with CODE 301 (Ashtray package/smoker package) without CODE 279 (Electronic gear selector) MODEL 212.074/077/274/277 with CODE 301 (Ashtray package/smoker package)	
16	Remove rear air vent (20)	MODEL 204 MODEL 212.0 (except 212.074/077), 212.1, 212.2 (except 212.274/277) without CODE 279 (Electronic gear selector) MODEL 212.074/077/274/277 MODEL 207.3 as of model year 2014 without CODE 427 (7-speed automatic transmission) MODEL 207.3 up to model year 2014	AR83.10-P-4800CW AR83.10-P-4800EC
17.1	Remove rear ashtray	MODEL 204 with CODE 301 (Ashtray package/smoker package) MODEL 207.3 as of model year 2014 with CODE 301 (Ashtray package/smoker package) without CODE 427 (7-speed automatic transmission) MODEL 207.3 up to model year 2014 with CODE 301 (Ashtray package/smoker package)	AR68.20-P-2230CW
17.2	Remove rear ashtray or stowage compartment	MODEL 212.0 (except 212.074/077), 212.1, 212.2 (except 212.274/277) without CODE 279 (Electronic gear selector) MODEL 212.074/077/274/277 i Removal of the stowage compartment corresponds to removal of the rear ashtray.	AR68.20-P-2230EW
17.3	Remove cover (18)	MODEL 204 without CODE 301 (Ashtray package/smoker package) MODEL 207.3 as of model year 2014 without CODE 301 (Ashtray package/smoker package) without CODE 427 (7-speed automatic transmission) MODEL 207.3 up to model year 2014 without CODE 301 (Ashtray package/smoker package)	
18	Unscrew bolts (26) from armrest mount	⚠ Assembly: Carefully tighten bolts (26). Otherwise the center console (1) can be damaged and must be replaced. i On model 204.0/2 up to 28.02.2011, 207.3, 212 with code 386 (Comfort telephony) is not necessary to remove the armrest (6) to completely remove the telephone mount (24) and the bluetooth module (A34/7). i On MODEL 204.0/2 as of 01.03.2011, MODEL 204.3 with CODE 386 (Comfort telephony) it is necessary to remove the armrest (6) for removing the mounting console (24).	

19	Unclip armrest (6) on lugs (27) on left and right side of center console (1) and move out toward rear	<p>⚠ Carefully unclip armrest (6). Otherwise the lugs (27) can break off.</p> <p>i On model 204.0/2 up to 28.02.2011, 207.3 , 212 with code 386 (Comfort telephony) is not necessary to remove the armrest (6) to completely remove the telephone mount (24) and the bluetooth module (A34/7).</p> <p>i On MODEL 204.0/2 as of 01.03.2011, MODEL 204.3 with CODE 386 (Comfort telephony) it is necessary to remove the armrest (6) for removing the mounting console (24).</p> <p> Mounting wedge</p>	*110589035900
20	Disconnect mobile phone electrical connector (X39/37)	<p>MODEL 204 with CODE 386 (Comfort telephony)</p> <p>MODEL 207.3 as of model year 2014 with CODE 386 (Comfort telephony) without CODE 427 (7-speed automatic transmission)</p> <p>MODEL 207.3 up to model year 2014 with CODE 386 (Comfort telephony)</p> <p>MODEL 212.0 (except 212.074/077), 212.1, 212.2 (except 212.274/277) with CODE 386 (Comfort telephony) without CODE 279 (Electronic gear selector)</p> <p>MODEL 212.074/077/274/277 with CODE 386 (Comfort telephony)</p>	
21	Disconnect separating point for USB electrical connector (X115x1)	<p>MODEL 204.0/2 as of 3/1/11 with CODE 512 (COMAND APS with DVD changer)</p> <p>MODEL 204.3 with CODE 512 (COMAND APS with DVD changer)</p> <p>MODEL 207.3 as of 6/1/12 up to model year 2014 with CODE 510 (Audio 20 CD with CD changer)</p> <p>MODEL 207.3 as of 6/1/12 up to model year 2014 with CODE 523 (MB Audio 20 radio)</p> <p>MODEL 207.3 as of 7/1/11 up to model year 2014 with CODE 512 (COMAND APS with DVD changer)</p> <p>MODEL 207.3 as of 7/1/11 up to model year 2014 with CODE 526 (COMAND (without navigation))</p> <p>MODEL 207.3 as of 7/1/11 up to model year 2014 with CODE 528 (COMAND with DVD changer)</p> <p>MODEL 207.3 as of model year 2014 without CODE 427 (7-speed automatic transmission)</p> <p>MODEL 207.3 up to model year 2014 with CODE 527 (COMAND APS with single DVD drive (with navigation))</p>	

22	Unclip Media Interface electrical connector (X18/70) and guide toward out through opening in connecting strip (41) or mounting console (39)	<p>MODEL 204.0/2 as of 3/1/11 with CODE 512 (COMAND APS with DVD changer) MODEL 204.3 with CODE 512 (COMAND APS with DVD changer) MODEL 207.3 as of 6/1/12 up to model year 2014 with CODE 510 (Audio 20 CD with CD changer) MODEL 207.3 as of 6/1/12 up to model year 2014 with CODE 523 (MB Audio 20 radio) MODEL 207.3 as of 7/1/11 up to model year 2014 with CODE 512 (COMAND APS with DVD changer) MODEL 207.3 as of 7/1/11 up to model year 2014 with CODE 526 (COMAND (without navigation)) MODEL 207.3 as of 7/1/11 up to model year 2014 with CODE 528 (COMAND with DVD changer) MODEL 207.3 as of model year 2014 without CODE 427 (7-speed automatic transmission) MODEL 207.3 up to model year 2014 with CODE 527 (COMAND APS with single DVD drive (with navigation))</p> <p>i On model 207.3 as of model year 2014 the connecting strip (41) will be eliminated. The electrical connector for Media Interface (X18/70) is clipped directly into the housing of the center console (1).</p>	
23	Detach center console (1) in rear area until bolt (40) at the bottom of the center console (1) is easily accessible	<p>MODEL 204.0/2 as of 3/1/11, 204.3 with CODE 386 (Comfort telephony) MODEL 204.0/2 as of 3/1/11, 204.3 with CODE 512 (COMAND APS with DVD changer) MODEL 204.0/2 as of 3/1/11, 204.3 with CODE 518 (Media interface) MODEL 207.3 as of 3/1/11 up to model year 2014 with CODE 386 (Comfort telephony) MODEL 207.3 as of 3/1/11 up to model year 2014 with CODE 512 (COMAND APS with DVD changer) MODEL 207.3 as of 3/1/11 up to model year 2014 with CODE 518 (Media interface) MODEL 207.3 as of model year 2014 with CODE 386 (Comfort telephony) without CODE 427 (7-speed automatic transmission)</p>	AR68.20-P-2000CW
24	Unscrew bolt (40) at bottom of center console (1) on mounting console mount (39) or connecting strip (41) depending on equipment.	<p>MODEL 204.0/2 as of 3/1/11, 204.3 with CODE 386 (Comfort telephony) MODEL 204.0/2 as of 3/1/11, 204.3 with CODE 512 (COMAND APS with DVD changer) MODEL 204.0/2 as of 3/1/11, 204.3 with CODE 518 (Media interface) MODEL 207.3 as of 3/1/11 up to model year 2014 with CODE 386 (Comfort telephony) MODEL 207.3 as of 3/1/11 up to model year 2014 with CODE 512 (COMAND APS with DVD changer) MODEL 207.3 as of 3/1/11 up to model year 2014 with CODE 518 (Media interface) MODEL 207.3 as of model year 2014 with CODE 386 (Comfort telephony) without CODE 427 (7-speed automatic transmission)</p>	

		<p>i On model 207.3 as of model year 2014 the connecting strip (41) will be eliminated.</p>	
25.1	Unclip mounting console (39) with assembly wedge (23) from center console (1) and remove	<p>MODEL 204.0/2 as of 3/1/11, 204.3 with CODE 386 (Comfort telephony) MODEL 207.3 as of 3/1/11 up to model year 2014 with CODE 386 (Comfort telephony) MODEL 207.3 as of model year 2014 with CODE 386 (Comfort telephony) without CODE 427 (7-speed automatic transmission)</p> <p>! Carefully unclip mounting console (39). Otherwise the catch hooks (25) can break and the mounting console (39) must be replaced.</p> <p>i Guide electrical lines (22) with mobile phone electrical connector (X39/37) through opening in center console (1).</p> <p>S Mounting wedge</p>	*110589035900
25.2	Unclip mounting console (24) with assembly wedge (23) and lay down to side in center console (1)	<p>MODEL 204.0/2 up to 2/28/11 with CODE 386 (Comfort telephony) MODEL 207.3 up to 2/28/11 up to model year 2014 with CODE 386 (Comfort telephony) MODEL 212.0 (except 212.074/077), 212.1, 212.2 (except 212.274/277) with CODE 386 (Comfort telephony) without CODE 279 (Electronic gear selector) MODEL 212.074/077/274/277 with CODE 386 (Comfort telephony)</p> <p>! Carefully unclip mounting console (24). Otherwise the catch hooks (25) can break and the mounting console (24) must be replaced.</p> <p>S Mounting wedge</p>	*110589035900
25.3	Unclip connecting strip (41) with assembly wedge (23) and remove	<p>MODEL 204.0/2 as of 3/1/11 with CODE 386 (Comfort telephony) MODEL 207.3 as of 3/1/11 up to model year 2014 with CODE 386 (Comfort telephony) MODEL 212.0 (except 212.074/077), 212.1, 212.2 (except 212.274/277) with CODE 386 (Comfort telephony) without CODE 279 (Electronic gear selector) MODEL 212.074/077/274/277 with CODE 386 (Comfort telephony)</p> <p>! Carefully unclip connecting strip (41). Otherwise the catch hooks can break and the connecting strip (41) must be replaced.</p> <p>i The catch hook on the connecting strip (41) is located at the same location as the catch hook (25) of the mounting console (39).</p> <p>S Mounting wedge</p>	*110589035900

26	Unclip USB electrical connector (X115) from connecting strip (41) and remove	<p>MODEL 204 with CODE 512 (COMAND APS with DVD changer) MODEL 207.3 as of 6/1/12 up to model year 2014 with CODE 510 (Audio 20 CD with CD changer) MODEL 207.3 as of 6/1/12 up to model year 2014 with CODE 523 (MB Audio 20 radio) MODEL 207.3 as of 7/1/11 up to model year 2014 with CODE 512 (COMAND APS with DVD changer) MODEL 207.3 as of 7/1/11 up to model year 2014 with CODE 526 (COMAND (without navigation)) MODEL 207.3 as of 7/1/11 up to model year 2014 with CODE 527 (COMAND APS with single DVD drive (with navigation)) MODEL 207.3 as of 7/1/11 up to model year 2014 with CODE 528 (COMAND with DVD changer) MODEL 207.3 as of model year 2014 without CODE 427 (7-speed automatic transmission)</p> <p>i On model 207.3 as of model year 2014 the connecting strip (41) will be eliminated. The USB electrical connector(X115) is directly clipped into the housing of center console (1)</p>	
27	Remove mounting console (24) from center console (1) until flap (28) is accessible	<p>MODEL 204.0/2 up to 2/28/11 with CODE 386 (Comfort telephony) MODEL 207.3 up to 2/28/11 up to model year 2014 with CODE 386 (Comfort telephony) MODEL 212.0 (except 212.074/077), 212.1, 212.2 (except 212.274/277) with CODE 386 (Comfort telephony) without CODE 279 (Electronic gear selector) MODEL 212.074/077/274/277 with CODE 386 (Comfort telephony)</p>	
28	Open flap (28) and Remove bolt (29)	<p>MODEL 204.0/2 up to 2/28/11 with CODE 386 (Comfort telephony) MODEL 207.3 up to 2/28/11 up to model year 2014 with CODE 386 (Comfort telephony) MODEL 212.0 (except 212.074/077), 212.1, 212.2 (except 212.274/277) with CODE 386 (Comfort telephony) without CODE 279 (Electronic gear selector) MODEL 212.074/077/274/277 with CODE 386 (Comfort telephony)</p>	
29	Unclip cover (30) from Bluetooth module (A34/7)	<p>MODEL 204 (except 204.9) with CODE 386 (Comfort telephony) MODEL 207.3 as of model year 2014 with CODE 386 (Comfort telephony) without CODE 427 (7-speed automatic transmission) MODEL 207.3 up to model year 2014 with CODE 386 (Comfort telephony) MODEL 212.0 (except 212.074/077), 212.1, 212.2 (except 212.274/277) with CODE 386 (Comfort telephony) without CODE 279 (Electronic gear selector) MODEL 212.074/077/274/277 with CODE 386 (Comfort telephony)</p>	
30.1	Guide Bluetooth module (A34/7) out mounting console (24)	<p>MODEL 204.0/2 up to 2/28/11 with CODE 386 (Comfort telephony) MODEL 207.3 up to 2/28/11 up to model year 2014 with CODE 386 (Comfort telephony) MODEL 212.0 (except 212.074/077), 212.1, 212.2 (except 212.274/277) with CODE 386 (Comfort telephony) without CODE 279 (Electronic gear selector) MODEL 212.074/077/274/277 with CODE 386 (Comfort telephony)</p>	

30.2	Unscrew bolt (35) and remove Bluetooth module (A34/7) from mounting console (36)	MODEL 204.0/2 as of 3/1/11 with CODE 386 (Comfort telephony) MODEL 204.3 with CODE 386 (Comfort telephony) MODEL 204.9 with CODE 386 (Comfort telephony) MODEL 207.3 as of 3/1/11 up to model year 2014 with CODE 386 (Comfort telephony) MODEL 207.3 as of model year 2014 with CODE 386 (Comfort telephony) without CODE 427 (7-speed automatic transmission)	
31	Remove Bluetooth module (A34/7) from mounting console (39)	MODEL 204.0/2 as of 3/1/11 with CODE 386 (Comfort telephony) MODEL 204.3 with CODE 386 (Comfort telephony) MODEL 204.9 with CODE 386 (Comfort telephony) MODEL 207.3 as of 3/1/11 up to model year 2014 with CODE 386 (Comfort telephony) MODEL 207.3 as of model year 2014 with CODE 386 (Comfort telephony) without CODE 427 (7-speed automatic transmission) MODEL 204.0/2 as of 3/1/11, 204.3 with CODE 386 (Comfort telephony) MODEL 207.3 as of 3/1/11 up to model year 2014 with CODE 386 (Comfort telephony) MODEL 207.3 as of model year 2014 with CODE 386 (Comfort telephony) without CODE 427 (7-speed automatic transmission)	AR82.70-P-8919EC AR82.70-P-8919ECA
32.1	Disconnect electrical connector (31) and remove Bluetooth module (A34/7) with associated electrical lines from center console (1)	MODEL 204.0/2 up to 2/28/11 with CODE 386 (Comfort telephony) MODEL 207.3 up to 2/28/11 up to model year 2014 with CODE 386 (Comfort telephony) MODEL 212.0 (except 212.074/077), 212.1, 212.2 (except 212.274/277) without CODE 279 (Electronic gear selector) MODEL 212.074/077/274/277	
32.2	Disconnect electrical connector (38) and remove Bluetooth module (A34/7) with associated electrical lines from center console (1)	MODEL 204.9 with CODE 386 (Comfort telephony)	
33	Remove center console (1) from vehicle		
34	Remove rear blower motor from center console (1)	MODEL 204 with CODE 581 (Comfort automatic air conditioning) MODEL 212.0 (except 212.074/077), 212.1, 212.2 (except 212.274/277) with CODE 581 (Comfort automatic air conditioning) without CODE 279 (Electronic gear selector) MODEL 212.074/077/274/277 with CODE 581 (Comfort automatic air conditioning)	AR83.30-P-5565EW
35	Assemble in the reverse order		

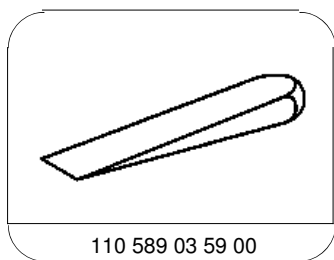

110 589 03 59 00

Mounting wedge