

- Parts list -

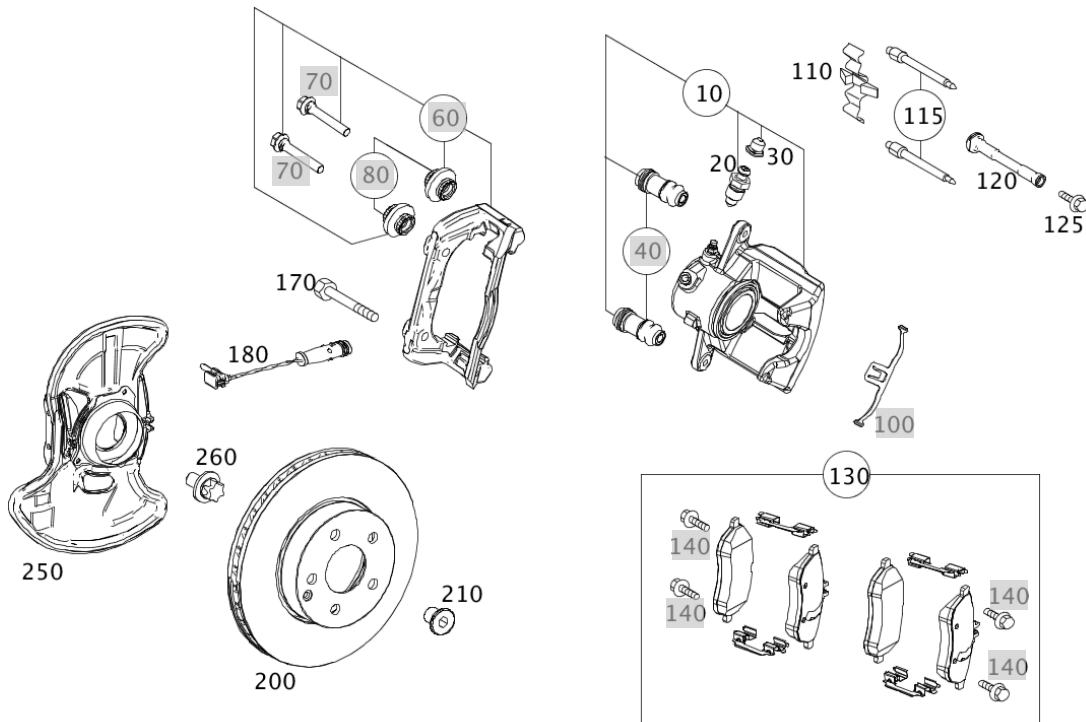















| | | | |
|-------------------------|-------------------|--------------------|-----------------------|
| Mode | BM mode | BM overview | C 63 AMG |
| VIN/mod. des. | WDD2043771F862195 | Catalog | 61F |
| VIN | WDDGJ7HB7CF862195 | Group | 42 BRAKES |
| Assortment class | PC | Sub-group | 030 FRONT WHEEL BRAKE |
| Market | | | |



Copyright 2019-08-19 Daimler AG

Image ID: drawing_B42030000157

| Item | Part number | Designation/additional information | Qty |
|------|-----------------|--|-----|
| 10 | A 204 421 21 11 | FIXED CALIPER PARTS SET, LEFT Code: M156+M63+(P30/P61)+U70; [697] PART IS ONLY OR ALSO SUPPLIED AS RECONDITION... | 1 |
| 10 | A 204 421 20 11 | FIXED CALIPER PARTS SET, RIGHT Code: M156+M63+(P30/P61)+U70; [697] PART IS ONLY OR ALSO SUPPLIED AS RECONDITION... | 1 |
| 20 | A 000 421 47 65 | * TS BLEED VALVE WITH DUST CAP Code: M156+M63+(P30/P61)+U70; | 2 |
| 30 | A 000 421 30 48 | ** DUST CAP BLEEDER VALVE Code: M156+M63+(P30/P61)+U70; | 4 |

| Item | Part number | Designation/additional information | Qty |
|------|-----------------|--|-----|
| 110 | A 001 421 09 91 | * SPREADER SPRING  Code: M156+M63+(P30/P61)+U70; | 2 |
| 115 | A 000 421 51 74 | * TS GUIDE PIN PARTS KIT  Code: M156+M63+(P30/P61)+U70; | 2 |
| 120 | A 221 421 00 14 | * DRAWBAR  Code: M156+M63+(P30/P61)+U70; | 2 |
| 125 | A 016 990 06 01 | * COMBI-HEXAGON HEAD BOLT  Code: M156+M63+(P30/P61)+U70; | 2 |
| 130 | A 005 420 89 20 | TS DISK BRAKE PAD PARTS KIT  Code: M156+M63+(P30/P61)+U70;  [431] WHEN SELLING BRAKE LININGS TO END USERS/DES... | 1 |
| 130 | A 007 420 65 20 | TS DISK BRAKE PAD PARTS KIT  Code: M156+M63+(P30/P61)+U70;  [431] WHEN SELLING BRAKE LININGS TO END USERS/DES... | 1 |
| 170 | A 001 990 08 14 | SCREW CALIPER TO STEERING KNUCKLE; M14X32  Code: M156+M63;  [408] ONLY REPLACEABLE BY PAIRS | 4 |
| 180 | A 171 540 06 17 | BRAKEPAD WEAR SENSOR BRAKE LINING WEAR INDICATOR  Code: M156+M63; | 1 |
| 200 | A 212 421 05 12 | BOND BRAKE DISK FRONT  Code: M156+M63+(P30/P61);  [408] ONLY REPLACEABLE BY PAIRS | 2 |
| 210 | A 220 421 01 71 | FIT SCREW BRAKE DISC TO WHEEL HUB; M8X12 | 2 |
| 250 | A 204 421 13 20 | SHIELD LEFT  Code: M156+M63; | 1 |
| 250 | A 204 421 14 20 | SHIELD RIGHT  Code: M156+M63; | 1 |
| 260 | A 220 423 00 71 | SCREW PROTECTIVE PLATE TO STEERING KNUCKLE; M6X12  Code: M156; | 6 |