

Parts Information

Parts Information

- Parts list -

Vehicle	C204077 (62P)	C 63 AMG	
Assortment class	PC	Group	14 INTAKE AND EXHAUST MANIFOLDS
Sub-group	030 INTAKE MANIFOLD		

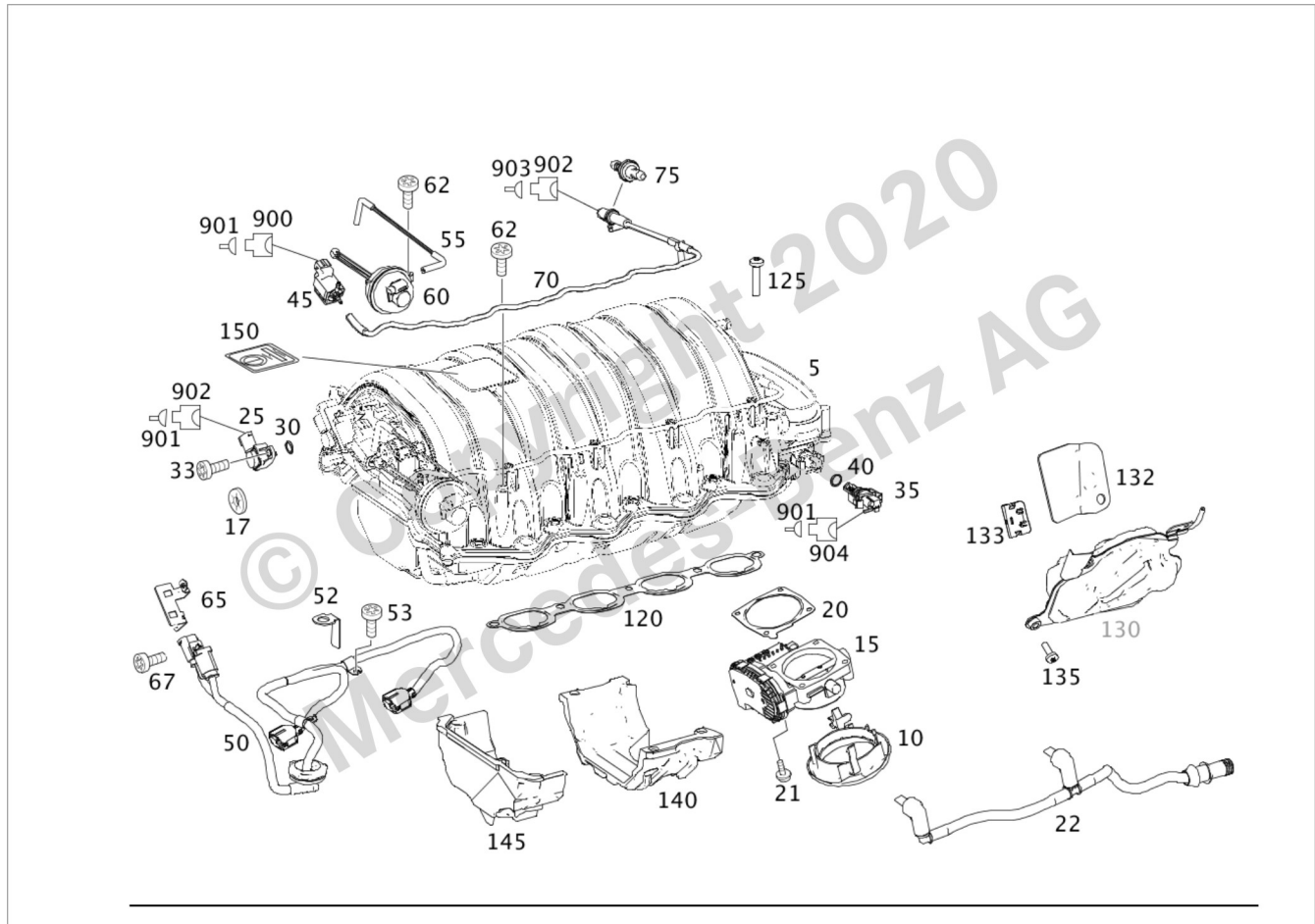









































Image ID: drawing_B14030000388

Item	Part number	Designation/additional information	Qty
5	A 156 141 08 01	INTAKE MANIFOLD [002936] FOR MODEL SERIES 164/251 TO IDENT 60 000591 ALSO ORDER A 156 010 02 70 Code: -(F204+(923/P98)); Fault location 14002	1
5	A 156 141 09 01	INTAKE MANIFOLD Code: F204+(923/P98/P61); Fault location 14003	1
5	A 156 141 08 01 	INTAKE MANIFOLD	1
10	A 156 141 02 08 	* FITTING ELECTRONIC GAS ACTUATOR TO INTAKE MANIFOLD	2



Parts Information

Item	Part number	Designation/additional information	Qty
15	A 156 141 02 25  	* SLIDE VALVE ELECTRONIC GAS ACTUATOR TO INTAKE MANIFOLD  Code: F164/F251/F230/F209/F211/F219/F216/F221/F204/F207/F212;	2
17	A 000 994 33 11 	* PIN LOCK ELECTRONIC GAS ACTUATOR TO INTAKE MANIFOLD	9
20	A 156 141 02 80 	* GASKET ELECTRONIC GAS ACTUATOR TO INTAKE MANIFOLD	2
21	A 009 990 28 04 	* CAP BOLT WITH SOCKET	8
22	A 156 018 05 12 	* BREATHER PIPE ELECTRONIC GAS ACTUATOR TO INTAKE MANIFOLD	1
25	A 005 153 50 28  	* PRESSURE SENSOR AT INTAKE MANIFOLD  Fault location 09159	1
30	A 027 997 27 48 	** SEALING RING	1
33	A 009 990 30 04 	* CAP BOLT WITH SOCKET SENDER UNIT TO INTAKE MANIFOLD	2
35	A 000 542 28 18 	* TEMPERATURE SENSOR INTAKE AIR Replaced by: A 651 153 00 28	1
35	A 651 153 00 28  	* TEMPERATURE SENSOR INTAKE AIR Replaces: A 000 542 28 18	1
40	A 601 997 04 48 	** SEALING RING 11X2	1
45	A 002 540 18 97 	* VALVE AT INTAKE MANIFOLD  Fault location 54596	1
50	A 156 150 12 33 	* ELECTRICAL WIRING HARNESS AT INTAKE MANIFOLD Replaced by: A 156 150 43 33	1
50	A 156 150 43 33 	* ELECTRIC LINE AT INTAKE MANIFOLD Replaces: A 156 150 12 33	1
52	A 000 994 08 01 	* SECURING CLIP	2
53	A 009 990 30 04 	* CAP BOLT WITH SOCKET LINE MOUNTING	2
55	A 156 140 02 64 	* AIR LINE BETWEEN ELECTRIC CHANGE-OVER VALVE AND VACUUM BOX	1
60	A 156 141 02 69 	* VACUUM CELL	1
62	A 009 990 29 04 	* CAP BOLT WITH SOCKET VACUUM BOX	2
62	A 009 990 30 04 	* CAP BOLT WITH SOCKET VACUUM CELL ON INTAKE MANIFOLD	13

Parts Information

Item	Part number	Designation/additional information	Qty
65	A 156 141 07 40 	* BRACKET WIRING HARNESS TO INTAKE PIPE  [402] NO LONGER AVAILABLE	1
67	A 009 990 30 04 	* CAP BOLT WITH SOCKET CABLE HARNESS BRACKET	2
70	A 156 140 03 64 	AIR LINE ELECTRIC CHANGE-OVER VALVE  Code: F164/F251/F230/F209/F211/F219/F216/F221/F204/F207/F212;	1
75	A 156 141 02 58 	* VALVE AT INTAKE MANIFOLD	1
120	A 156 141 03 80	METAL SEAL LEFT CYLINDER HEAD  Fault location 14A06 Replaced by: A 156 141 04 80 Replaced by: A 159 141 05 80	1
120	A 156 141 04 80	METAL SEAL LEFT CYLINDER HEAD  Fault location 14A06 Replaced by: A 159 141 05 80 Replaces: A 156 141 03 80	1
120	A 159 141 05 80	METAL SEAL LEFT CYLINDER HEAD  Fault location 14A06 Replaces: A 156 141 04 80 Replaces: A 156 141 03 80	1
120	A 156 141 03 80	METAL SEAL RIGHT CYLINDER HEAD  Fault location 14A06 Replaced by: A 156 141 04 80 Replaced by: A 159 141 05 80	1
120	A 156 141 04 80	METAL SEAL RIGHT CYLINDER HEAD  Fault location 14A06 Replaced by: A 159 141 05 80 Replaces: A 156 141 03 80	1
120	A 159 141 05 80	METAL SEAL RIGHT CYLINDER HEAD  Fault location 14A06 Replaces: A 156 141 04 80 Replaces: A 156 141 03 80	1
125	N 000000 001153	HEXALOBULAR BOLT INTAKE MANIFOLD TO CYLINDER HEAD; M8X40 Replaced by: A 004 990 53 12	10
125	A 004 990 53 12	HEXALOBULAR BOLT INTAKE MANIFOLD TO CYLINDER HEAD; M8X40 Replaces: N 000000 001153	10
132	A 156 150 00 75  	SHIELD FROM ACCUMULATOR TO ENGINE	1

Parts Information

Item	Part number	Designation/additional information	Qty
133	A 009 988 08 78  	* CLAMP	1
135	N 000000 001145	HEXALOBULAR BOLT AT CYLINDER CRANKCASE; M6X12	1
135	N 000000 001428	HEXALOBULAR BOLT AT CYLINDER CRANKCASE; M8X25	1
140	A 156 226 04 85	DAMPING SUCTION CONNECTION	1
145	A 156 226 05 85	DAMPING SUCTION CONNECTION	1
150	A 000 221 12 01	ENGINE PLATE  Code: F164/F204/F251/F230/F209/F211/F219/F216/F221; Replaced by: A 000 221 24 01	1
150	A 000 221 24 01	ENGINE PLATE  Code: F164/F204/F251/F230/F209/F211/F219/F216/F221; Replaces: A 000 221 12 01	1
150	A 000 221 24 01	ENGINE PLATE  Code: F204+(923/P61);	1
150	A 000 221 26 01	ENGINE PLATE  Code: (F204/F207/F212)+P98;	1
900	A 210 540 20 81	RECEPTACLE HOUSING AIR PUMP Y32; 2-PIN MQS	1
901	A 000 545 69 80	SEAL 1.4-1.9 MM MQS/MCP1.2	NB
901	A 000 545 68 80	SEAL YELLOW; 0.9-1.4 MM MQS/MCP1.2	NB
902	A 210 540 21 81	CLUTCH, MECHANICAL PESSURE SENSOR ON INTAKE MANIFOLD B28; 3-PIN MQS	1
903	A 009 545 81 26	CONTACT SOCKET 0.75-1.0 MM2 SLK2.8	NB
903	A 000 545 28 39	CORE BUNDLE SEALING LIGHT BLUE; 1.2-2.1MM JPT AMP-MCP TE1.5 AMP	NB
904	A 210 540 20 81	RECEPTACLE HOUSING INTAKE AIR TEMPERATURE SENSOR B17; 2-PIN MQS	1