

Parts Information

Parts Information

- Parts list -

Vehicle	C204077 (62P)	C 63 AMG	
Assortment class	PC	Group	32 Springs, suspension and hydraulic components
Sub-group	154 Rear suspension strut and suspension strut mount		

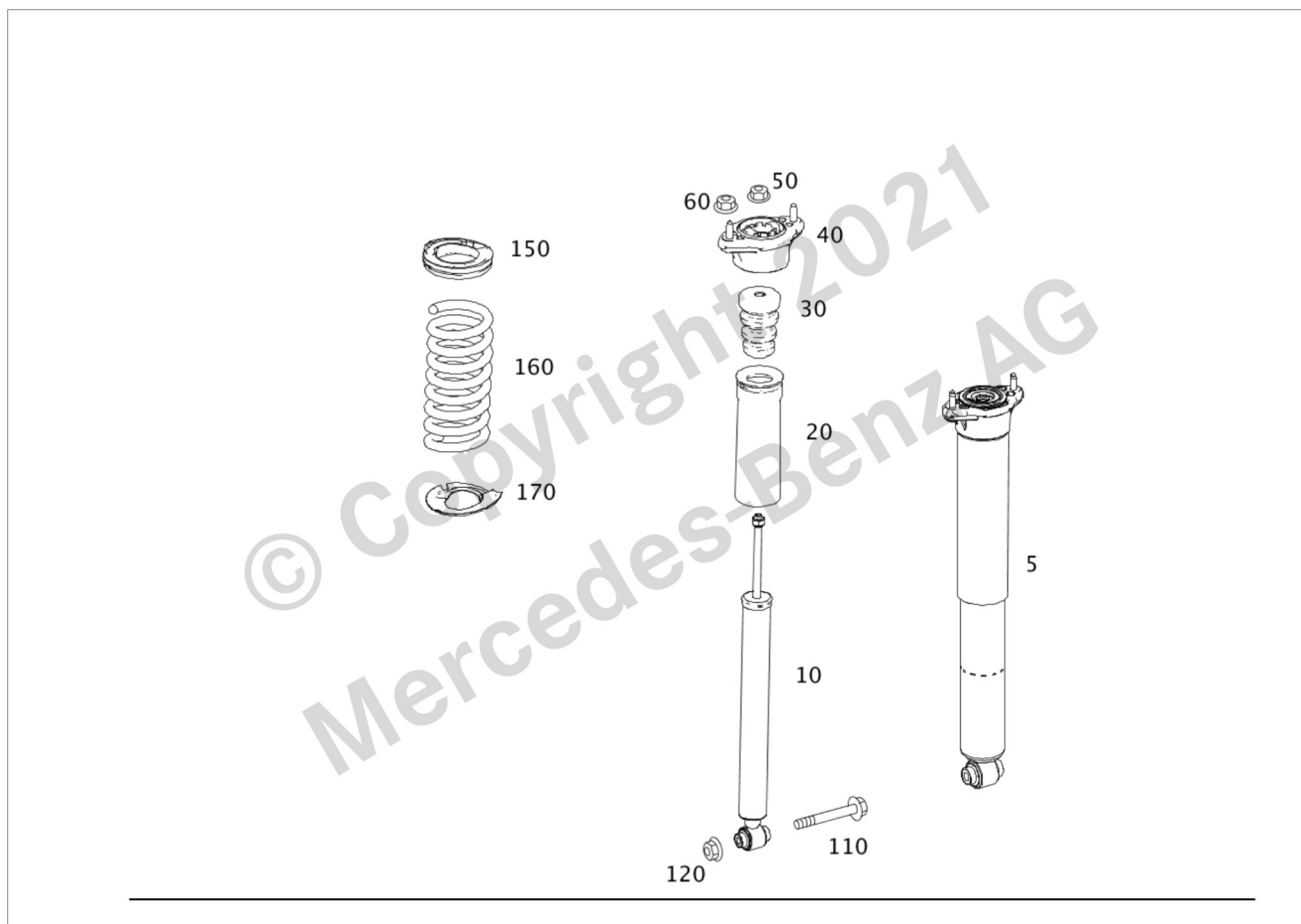



























































Image ID: drawing_B3215400010

Item	Part number	Designation/additional information	Qty
5	A 204 326 59 00 	SHOCK ABSORBER REAR LEFT AND RIGHT  Code: (M156+M63)+(808/809/800/801);  Fault location 32311	2
5	A 204 326 69 00 	SHOCK ABSORBER REAR LEFT AND RIGHT  Code: (M156+M63)+(808/809/800/801);  Fault location 32311 Replaces: A 204 326 68 00	2
5	A 204 320 12 31	SHOCK ABSORBER REAR LEFT AND RIGHT  Code: M156+M63;  Fault location 32A04	2

Parts Information

Item	Part number	Designation/additional information	Qty
5	A 204 326 59 00	SHOCK ABSORBER REAR LEFT AND RIGHT  Code: (M156+M63+P30)+(807/808/809/800+-050);  Fault location 32311	2
5	A 204 320 09 31	SHOCK ABSORBER REAR LEFT AND RIGHT  Code: M156+M63+492;  Fault location 32A04	2
5	A 204 326 09 00	SHOCK ABSORBER REAR LEFT AND RIGHT  Code: 485;  Fault location 32311	2
5	A 204 326 02 00	SHOCK ABSORBER REAR LEFT AND RIGHT  Code: 677;  Fault location 32311	2
5	A 204 326 02 04	SHOCK ABSORBER REAR LEFT AND RIGHT  Code: B00+677;  Fault location 32A04 Replaced by: A 204 326 13 04	2
5	A 204 326 13 04	SHOCK ABSORBER REAR LEFT AND RIGHT  Code: B00+677;  Fault location 32A04 Replaces: A 204 326 02 04	2
5	A 204 326 09 00 	SHOCK ABSORBER REAR LEFT AND RIGHT  Code: 485+(700/830);  Fault location 32311 Replaced by: A 204 326 01 04	2
5	A 204 326 01 04 	SHOCK ABSORBER REAR LEFT AND RIGHT  Code: 485+(700/830)/B00+485+700;  Fault location 32311 Replaces: A 204 326 09 00	2
5	A 204 326 12 04 	SHOCK ABSORBER REAR LEFT AND RIGHT  Code: 485+(700/830)/B00+485+700;  Fault location 32311	2
10	A 204 326 60 00 	* SHOCK ABSORBER REAR LEFT AND RIGHT  Code: (M156+M63)+(808/809/800/801);  Fault location 32A04	2
10	A 204 326 68 00 	* SHOCK ABSORBER REAR LEFT AND RIGHT  [417] IS NO LONGER DELIVERED, ORDER DELIVERY CONTENTS  Code: (M156+M63)+(808/809/800/801);  Fault location 32A04 Replaced by: A 204 326 69 00	2

Parts Information

Item	Part number	Designation/additional information	Qty
10	A 204 326 60 00	* SHOCK ABSORBER REAR LEFT AND RIGHT  Code: (M156+M63+P30)+(807/808/809/800+-050);  Fault location 32A04	2
20	A 204 326 03 98	* PROTECTIVE TUBE REAR SHOCK ABSORBERS  [417] IS NO LONGER DELIVERED, ORDER DELIVERY CONTENTS  Code: (M156+M63)+(809/800/801/802);  Fault location 32308	2
30	A 204 321 11 06 	* STOP BUFFER REAR SHOCK ABSORBERS  Code: M156+M63;  Fault location 32335	2
30	A 204 321 01 06 	* STOP BUFFER REAR SHOCK ABSORBERS  [417] IS NO LONGER DELIVERED, ORDER DELIVERY CONTENTS  Code: M156+M63;  Fault location 32335	2
30	A 204 321 11 06	* STOP BUFFER REAR SHOCK ABSORBERS  Code: (M156+M63+P30)+(807/808/809/800+-050);  Fault location 32335	2
40	A 204 320 08 73	* SUPPORT BUSHING BUMPER TO BODY  [417] IS NO LONGER DELIVERED, ORDER DELIVERY CONTENTS  Code: M156+M63;  Fault location 32C06	2
50	N 913023 010004	* NUT SHOCK ABSORBER TO BEARING; M10X1  Code: (M156+M63)+(809/800/801/802);	2
50	N 913023 010004	* NUT SHOCK ABSORBER TO BEARING; M10X1  Code: 483;	2
60	A 002 990 37 54	HEXAGON NUT WITH FLANGE MOUNTING TO BODY	4
110	N 000000 000295	HEXALOBULAR BOLT SHOCK ABSORBER TO SPRING CONTROL ARM	2
120	N 913023 010002	NUT SHOCK ABSORBER TO SPRING CONTROL ARM; M10  [414] THE OLD PART MUST NO LONGER BE INSTALLED Replaced by: N 000000 008270	2
120	N 000000 008270	NUT SHOCK ABSORBER TO SPRING CONTROL ARM; M10 Replaces: N 913023 010002	2
150	A 210 325 01 84	SPRING RETAINER INSERT TOP; STUD COUNT: 1 (5mm)  Code: -479;  Fault location 32012	2

Parts Information

Item	Part number	Designation/additional information	Qty
150	A 210 325 02 84	RUBBER BOOT TOP; STUD COUNT: 2 (9mm) Code: -479; Fault location 32012	2
150	A 210 325 03 84	RUBBER BOOT TOP; STUD COUNT: 3 (13mm) Code: -479; Fault location 32012	2
150	A 210 325 04 84	RUBBER BOOT TOP; STUD COUNT: 4 (17mm) Code: -479; Fault location 32012	2
160	A 204 324 07 04 	REAR SPRING [002819] UPON EXCHANGING SPRING, ALWAYS REPLACE LOWER SPRING SEAL Code: M156+M63; Fault location 32D06	2
160	A 204 324 06 04 	REAR SPRING [002819] UPON EXCHANGING SPRING, ALWAYS REPLACE LOWER SPRING SEAL Code: M156+M63; Fault location 32D06	2
160	A 204 324 07 04	REAR SPRING [002819] UPON EXCHANGING SPRING, ALWAYS REPLACE LOWER SPRING SEAL Code: (M156+M63+P30)+(807/808/809/800+-050); Fault location 32D06	2
160	A 204 324 07 04	REAR SPRING [002819] UPON EXCHANGING SPRING, ALWAYS REPLACE LOWER SPRING SEAL Code: M156+M63+492; Fault location 32D06	2
170	A 204 324 01 84	SPRING SHIM BOTTOM Fault location 32078	2