

P68.30-2779-09

Shown on model 220.0

- 1 Trunk floor paneling
 2 Luggage net
 3 Bolt
 4 Luggage net hook
 5 Rear end plate paneling

- 6 Double mounting clip
 7 Battery cover
 8 Spreading clip
 9 Right side paneling
 10 Left side paneling

- 12 Mounting frame
 13 Bolt
 14 Rear wall paneling
 E18/1 Trunk lamp



P31.10-2144-01

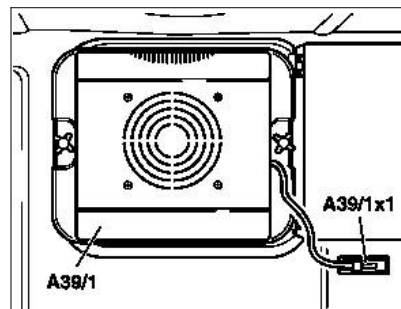

P86.61-2020-01

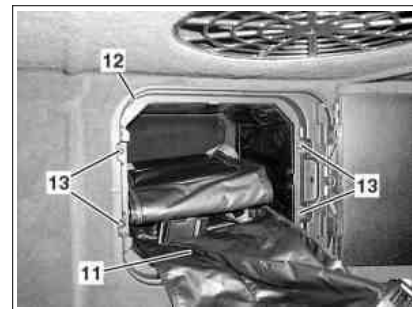

P91.22-2124-01

Code 550 trailer hitch



A63 Towing hitch release



Code 308 refrigerator box in center rear backrest

A39/1 Rear backrest refrigerator box
 A39/1x1 Rear backrest refrigerator box connector

Code 282a ski bag (through-loading feature)

11 Ski bag
 12 Mounting frame
 13 Bolts

 	Remove/install		
1	Remove trunk floor paneling (1)		
2	Unhook luggage net (2)		
3	Unscrew bolt (3, 4 each) from luggage net hooks (4, 4 each) from inside of rear end paneling (5).		
4.1	Pull double mounting clip (6, 8 each) out of rear end paneling (5)	Model 220.0/1.	
4.2	Pull double mounting clip (6, 4 each) out of rear end paneling (5)	Model 215.3.	
5	Remove rear end paneling (5)		
6.1	Remove battery cover (7)	Model 220.0/1.	
7	Pull spreading clip (8) out at top of right side paneling (9)		
8	Unscrew bolt (3) from luggage net hook (4) at bottom of right side paneling (9)		

9	Remove right side paneling (9).		
10.1	Remove manual control lever for mechanically pivoting trailer hitch	With code 550 trailer hitch  Unlock ball neck and secure against random locking	AR31.11-P-8010M
11	Pull spreading clips (8, 2 each) out at top of left side paneling (10)		
12	Pull bolt (3) for luggage net hook (4) from bottom of left side paneling (10)		
13	Remove left side paneling (10)		
14.1	Remove refrigerator box	With code 308 refrigerator box in center rear backrest	AR86.61-P-1010MP
14.2	Unclip ski bag from mounting frame (12)	With code 282a ski bag (through-loading feature).	
15.1	Unscrew bolts (13, 4 each) and remove mounting frame (12) from rear wall paneling (14).	With code 308 refrigerator box in center rear backrest, or code 282a ski bag (through-loading feature).	
16	Unclip trunk lamp (E18/1) from rear wall paneling (14) and disconnect electrical connector	 Assembly wedge	*110589035900
17	Pull spreading clips (8, 2 each) out at top of rear wall paneling (14)		
18.1	Unclip rear backrest refrigerator box connector (A39/1x1) from rear wall paneling (14)	With code 308 refrigerator box in center rear backrest	
19	Remove rear wall paneling (14)		
20	Install in the reverse order		

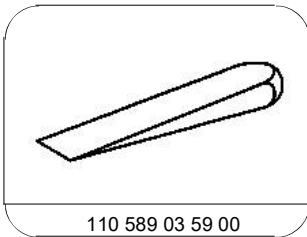

110 589 03 59 00

Assembly wedge