

MODEL 208

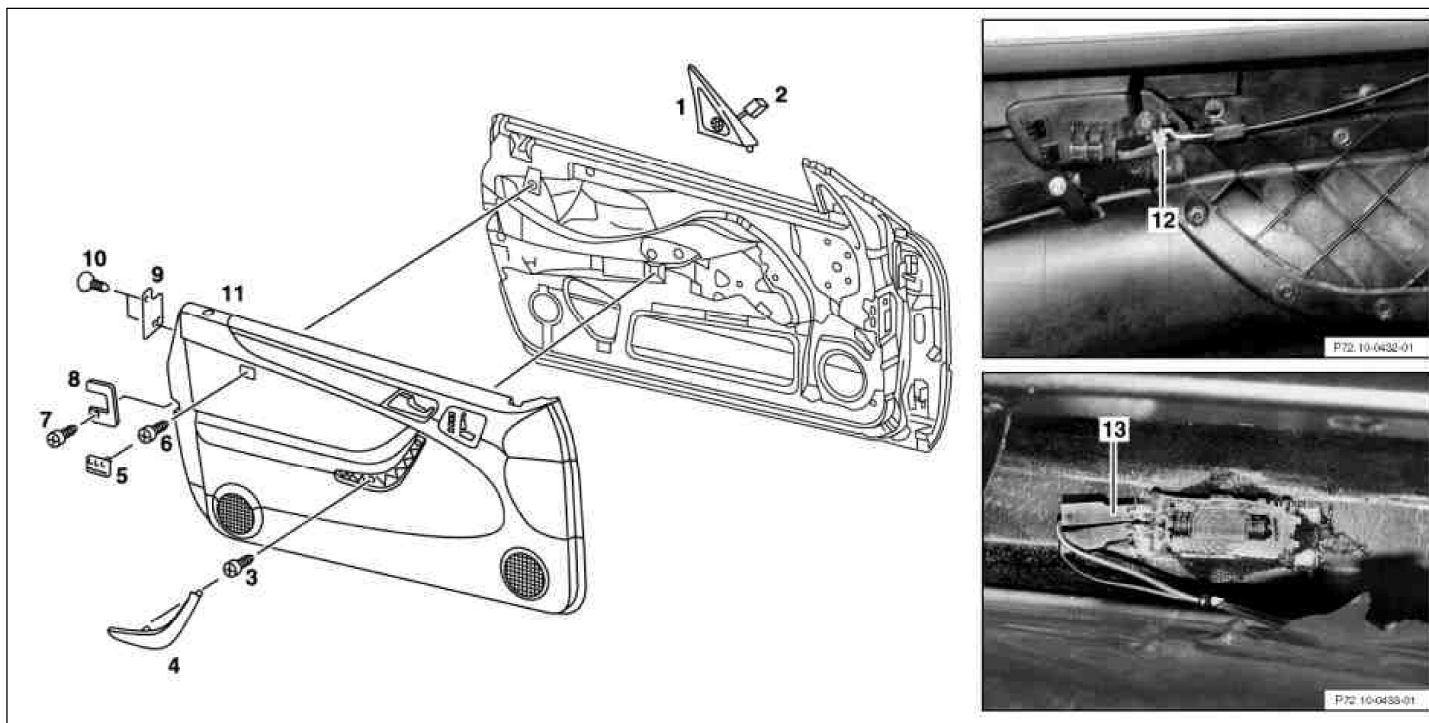













P72.10-0434-09

- 1 Cover for door speaker (tweeter)
 2 Separation point for door speaker
 3 Screw
 4 Cover
 5 Cover (SRS side airbag)

- 6 Screw
 7 Screw
 8 Round cover plate
 9 Cover

- 10 Screw
 11 Door liner
 12 Control cable
 13 Separation point (entrance/exit lamp)

|   | Removal, installation | | |
|--|---|---|---------------|
| 1 | Open crank window | | |
| 2 | Unclip cover for door speaker (1) with installation wedge and disconnect door speaker (2) at separation point |  | *110589035900 |
| 3 | Remove cover (4) |  Press off cover (4) from bottom with long wedge  | *115589035900 |
| 4 | Unscrew screw (3) | | |
| 5 | Unclip cover (5) with long wedge |  Only on vehicles with code 292 (front left and right side airbags)  | *115589035900 |
| 6 | Unscrew screw (6) | | |
| 7 | Remove round cover plate (8) | | |
| 8 | Remove cover (9) | | |
| 9 | Press off door liner (1) at bottom of inner door panel, at front and rear with installation wedge |   Insert installation wedge directly next to each clip | *110589035900 |
| 10 | Lift door liner (11) at top along sealing rail upward out of clips with installation wedge and simultaneously pull away from inner door panel |   Installation: Insert door lock linkage into eyelet in door liner (11) | *110589035900 |
| 11 | Unhook control cable (12) from door inner actuating mechanism |  On vehicles with code 221a and 222a, electrically adjustable left and right front seats, disconnect connector for seat adjustment on door control module. | |

| | | | |
|----|--|--|---------------------|
| 12 | Disconnect entrance/exit lamp at separation point (13) | | |
| 13 | Lay door liner (11) down on clean surface | | |
| 14 | Check door foil on inner door plate and clips on door liner (11) |  Replace door foil and clips if damaged, glue door foil onto inner door panel | *BR00.45-Z-1005-02A |
| 15 | Reinstall in opposite order | | |

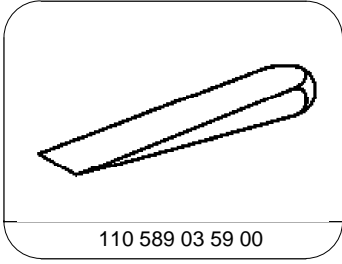

110 589 03 59 00

Installation wedge

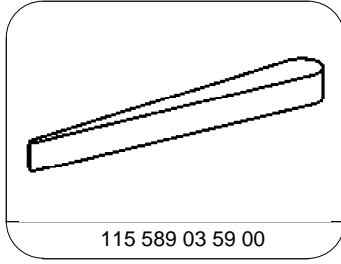

115 589 03 59 00

Long wedge

Service products for repair

| Number | Designation | Order number |
|--------------------|---|---------------|
| BR00.45-Z-1005-02A | MB PVC glue for gluing PVC foils to cardboard and sheet metal (350 g brush can) | 001 989 30 71 |