

- Parts list -

Mode	BM mode	Catalog	D33
VIN/mod. des.	WDD2183741A027191	Group	32
VIN	WDDLJ7EBXCA027191		SPRINGS,SUSPENSION AND HYDRAULICS
Assortment class	PC	Sub-group	054 SPRING STRUT AND SPRING STRUT MOUNTING FRONT
Market			
BM overview	CLS 63 AMG		

Copyright 2020-02-28 Daimler AG

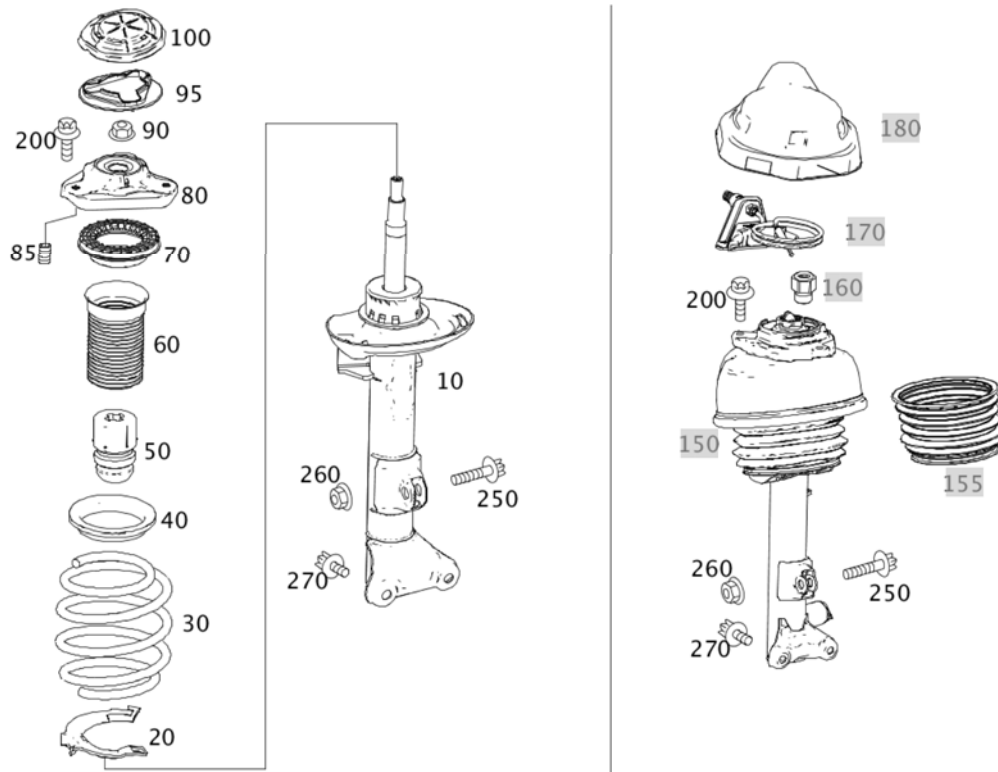



























Image ID: drawing_B32054000047

Item	Part number	Designation/additional information	Qty
10	A 218 323 19 00	SHOCK-ABSORBER STRUT FRONT AXLE,LEFT 📅 Code: M157+M55+488+802+-(052/M005);	1
10	A 218 323 20 00	SHOCK-ABSORBER STRUT FRONT AXLE,RIGHT 📅 Code: M157+M55+488+802+-(052/M005);	1
20	A 204 321 01 84	ELASTOMER SHIM BOTTOM LEFT & RIGHT 📅 Code: M157+M55+488; 🔧 Fault location 33362	2

Item	Part number	Designation/additional information	Qty
30	A 218 321 28 04	COIL SPRING COLOR CODING; 1 X BLUE/1 X GREEN/1 X WHITE  Code: M157+M55+488+-(489/M005);  [002819] UPON EXCHANGING SPRING, ALWAYS REPLACE LOWER SPRING SEAL  Fault location 32B02	2
40	A 212 322 04 84	COIL SPRING SHIM TOP LEFT AND RIGHT  Code: (M157+M55+488)+-489;  Fault location 33362	2
50	A 218 321 04 06	AUXILIARY SPRING LEFT AND RIGHT  Code: M157+M55+488+-489;  Fault location 32321	2
60	A 204 323 02 92	BOOT LEFT AND RIGHT  Code: M157+M55+488+-489;  Fault location 32322	2
70	A 204 981 00 25	BALL BEARING LEFT AND RIGHT  Code: -(489/M005);  Fault location 32129	2
80	A 212 323 05 20	SUPPORT BUSHING SUSPENSION STRUT AT BODY, LEFT  Code: M157+M55+488+-489;	1
80	A 212 323 04 20 	SUPPORT BUSHING SUSPENSION STRUT AT BODY, RIGHT  Code: M157+M55+488+-489;	1
85	N 900421 008002 	* THREADED INSERT LEFT MOUNTING  Code: M157+M55+488;	3
85	N 900421 008002 	* THREADED INSERT RIGHT MOUNTING  Code: M157+M55+488;	3
90	N 000000 003277	NUT SHOCK ABSORBER TO UPPER BEARING BRACKET; M14X1.5  Code: M157+M55+488;	2
95	A 212 327 07 86	COVER LEFT  Code: M157+M55+488;	1
95	A 212 327 06 86	COVER RIGHT  Code: M157+M55+488;	1
100	A 212 327 03 86	COVER ON SPRING TOWER  Code: M157+M55+488;  Fault location 32128	2
200	A 002 990 45 03	SCREW WITH FEATURE SPRING STRUT TO BODY; M8X21	6
250	A 000 990 24 03	SCREW WITH FEATURE HYDROPNEUMATIC SPRING LEG TO STEERING KNUCKLE, TOP; M14X1.5X45	2

Item	Part number	Designation/additional information	Qty
260	A 001 990 84 54	HEX. NUT W FLANGE A PART HYDROPNEUMATIC SPRING LEG TO STEERING KNUCKLE, TOP; M14X1.5  Plant information	2
270	A 000 990 91 03	COMBI-SCREW W FEATURE HYDROPNEUMATIC SPRING LEG TO STEERING KNUCKLE, BOTTOM; M12X20  Fault location 3201F	4