

MODEL 212.0 (except 212.074/077), 212.1, 212.2 (except 212.274/277)
with CODE 279 (Electronic gear selector)

MODEL 218 (except 218.374/375/376/392/974/975/976/992)

Modification notes

30.4.14	"Remove and install Audio/COMAND control panel" added	Operation steps 7, 12, 17 and 23
---------	-------------------------------------------------------	----------------------------------

Shown on model 212 up to model year 2014

6 Right cover (MODEL 212)
7 Left cover (MODEL 212)

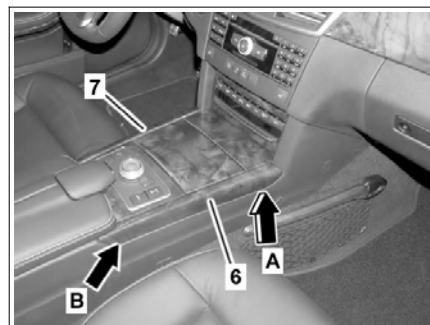

P68.20-4543-01

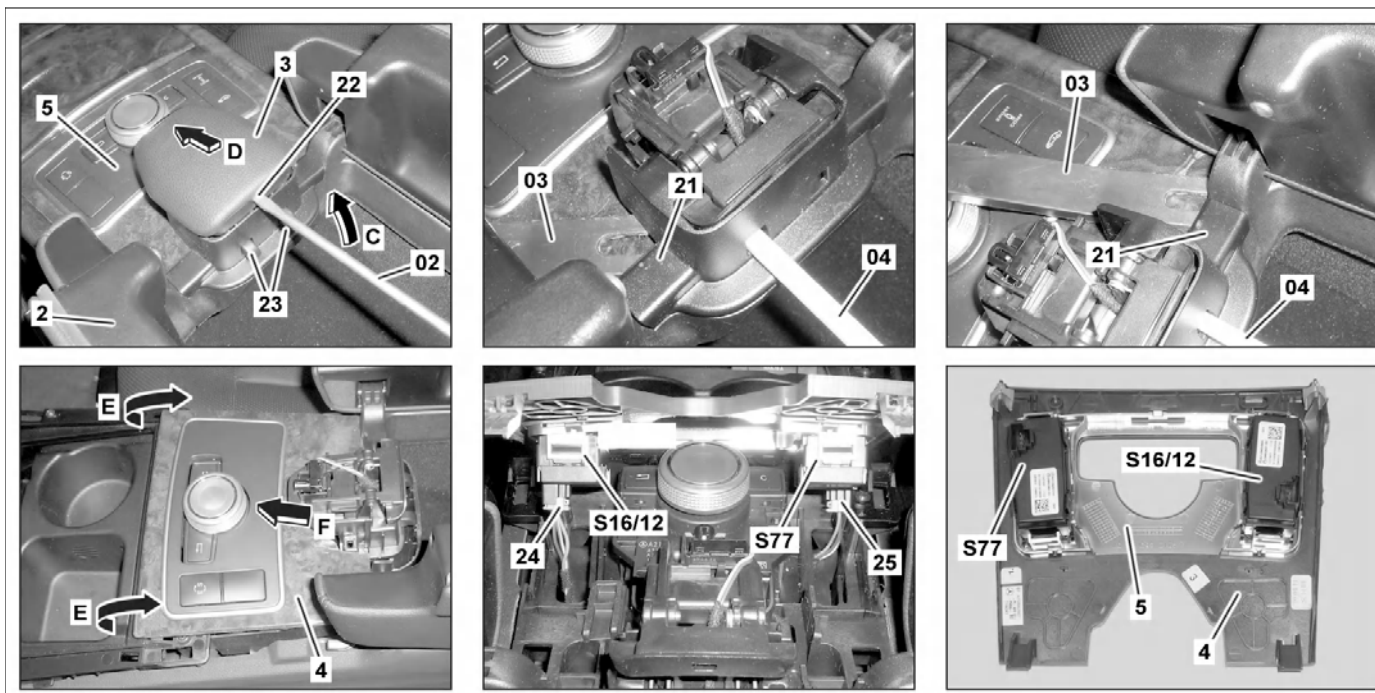

P68.20-4541-09

Shown on model 212 up to model year 2014 (with CODE 489 (AIRmatic (air suspension with continuous adjustment damping)))

02	Flat screwdriver	4	Center cover	24	Electrical connector
03	Clip remover	5	Cover for button group (MODEL 212 up to model year 2014, model 218 up to model year 2015)	25	Electrical connector (with CODE 489 (AIRmatic (Air suspension with continuous adjustment damping)))
04	Feeler gauge	21	Lock cover	S16/12	Automatic transmission mode button
2	Rear stowage compartment	22	Cutout	S77	Suspension button group (with CODE 489 (AIRmatic (air suspension with continuous adjustable damping)))
3	Release handle cover	23	Latch		

Shown on model 212 as of model year 2014 (with CODE 489 (AIRMATIC (air suspension with continuous adjustment damping)))

- 4 Center cover
- 24 Electrical connector
- 26 Electrical connector (MODEL 212 as of model year 2014, model 218 as of model year 2015)
- A40/9 Audio/COMAND control panel
- S16/12 Automatic transmission mode button (with CODE 489 (AIRMATIC (air suspension with continuous adjustment damping)))

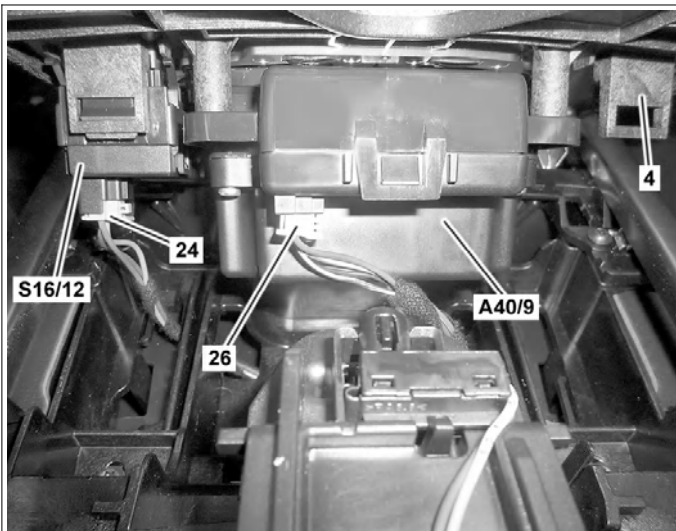

P68.20-4800-11

Shown on model 212 as of model year 2014

- 4 Center cover
- 30 Bolts (MODEL 212 as of model year 2014, model 218 as of model year 2015)
- A40/9 Audio/COMAND control panel
- S16/12 Automatic transmission mode button

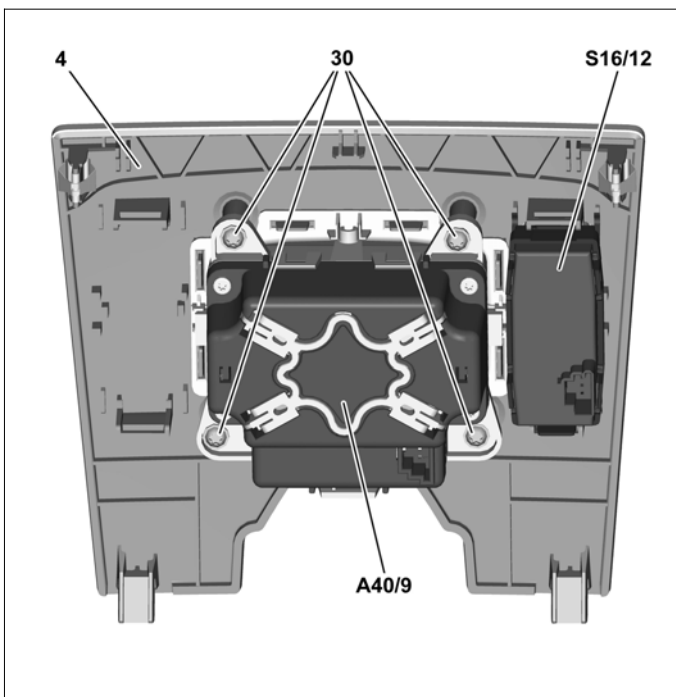



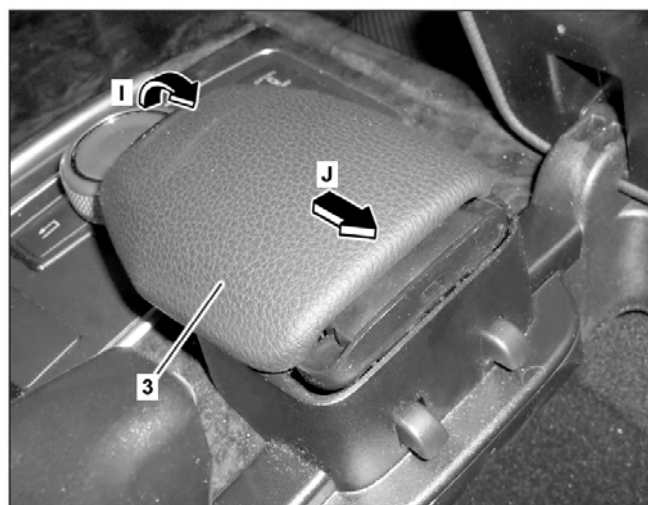
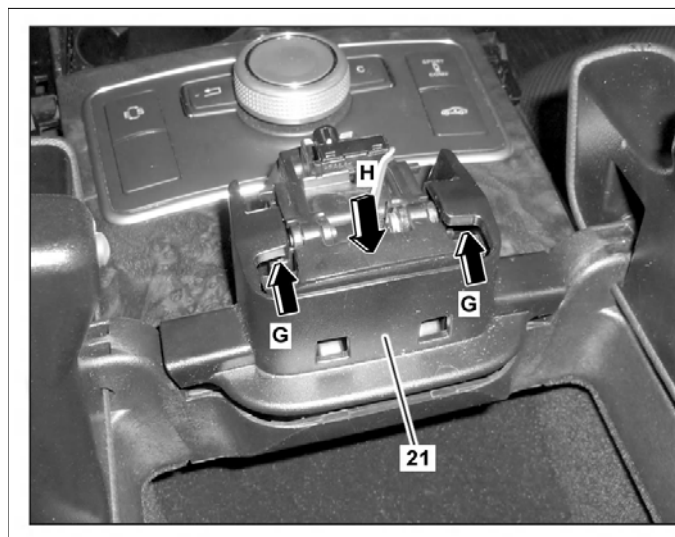





P68.20-4801-12



P68.20-4542-08

MODEL 212, shown up to model year 2014

	Information on preventing damage to electronic components due to electrostatic discharge		AH54.00-P-0001-01A
	Remove		
1.1	Switch off ignition and remove transmitter key from electronic ignition lock control unit	MODEL 212.0 (except 212.074/077), 212.1, 212.2 (except 212.274/277) with CODE 279 (Electronic gear selector) without CODE 889 (KEYLESS-GO) MODEL 218 (except 218.374/375/376/392/974/975/976/992) without CODE 889 (KEYLESS-GO)	
1.2	Switch off ignition and remove transmitter key or KEYLESS-GO start/stop button from electronic ignition lock control unit	MODEL 212.0 (except 212.074/077), 212.1, 212.2 (except 212.274/277) with CODE 279 (Electronic gear selector) with CODE 889 (KEYLESS-GO) MODEL 218 (except 218.374/375/376/392/974/975/976/992) with CODE 889 (KEYLESS-GO)	
2	Open rear stowage compartment (2)		
3	Reach into cutout (22) with suitable flat screwdriver (02), pivot upward (arrow C) and push release handle cover (3) toward front (arrow D) and remove		
4	Press catch hooks into lock cover (21) with clip remover (03), simultaneously push lock (23) toward rear with feeler gauge (04) and remove lock cover (21) upward	 Feeler gauge  Clip remover	*129589032100 *452589016300
5	Unclip center cover (4) (arrows E), then push toward front (arrow F) and remove		
6	Disconnect electrical connector (24) from automatic transmission mode button (S16/12)		
7	Disconnect electrical connector (26) from audio/COMAND operating unit (A40/9)	MODEL 212.0 (except 212.074/077), 212.1, 212.2 (except 212.274/277) as of model year 2014 with CODE 279 (Electronic gear selector) MODEL 218 (except 218.374/375/376/392/974/975/976/992) as of model year 2015	
8	Detach electrical connection (25) from suspension button group (S77)	MODEL 212.0 (except 212.074/077), 212.1, 212.2 (except 212.274/277) with CODE 279 (Electronic gear selector) with CODE 489 (AIRMATIC) MODEL 218 (except 218.374/375/376/392/974/975/976/992) with CODE 489 (AIRMATIC)	
9	Unclip cover for button group (5) from center cover (4)	MODEL 212.0 (except 212.074/077), 212.1, 212.2 (except 212.274/277) up to model year 2014 with CODE 279 (Electronic gear selector) MODEL 218 (except 218.374/375/376/392/974/975/976/992) up to model year 2015 When replacing center cover (4).	
10	Unclip suspension button group (S77) from center cover (4)	MODEL 212.0 (except 212.074/077), 212.1, 212.2 (except 212.274/277) as of model year 2014 with CODE 279 (Electronic gear selector) with CODE 489 (AIRMATIC) MODEL 218 (except 218.374/375/376/392/974/975/976/992) as of model year 2015 with CODE 489 (AIRMATIC) When replacing center cover (4).	
11	Unclip automatic transmission mode button (S16/12) from center cover (4)	MODEL 212.0 (except 212.074/077), 212.1, 212.2 (except 212.274/277) as of model year 2014 with CODE 279 (Electronic gear selector) MODEL 218 (except 218.374/375/376/392/974/975/976/992) as of model year 2015 When replacing center cover (4).	

12	Unscrew bolts (30) and remove Audio/COMAND operating unit (A40/9) from center cover (4)	MODEL 212.0 (except 212.074/077), 212.1, 212.2 (except 212.274/277) as of model year 2014 with CODE 279 (Electronic gear selector) MODEL 218 (except 218.374/375/376/392/974/975/976/992) as of model year 2015 When replacing center cover (4).	
13	Unclip left cover (7) or right cover (6) in front area with assembly wedge in direction of arrow (arrow A), unhook in rear area (arrow B) and remove	MODEL 212.0 (except 212.074/077), 212.1, 212.2 (except 212.274/277) with CODE 279 (Electronic gear selector)  Mounting wedge	*110589035900
	Install		
14	Hook in right cover (6) in rear area and then clip in at front	MODEL 212.0 (except 212.074/077), 212.1, 212.2 (except 212.274/277) with CODE 279 (Electronic gear selector)	
15	Hook in left cover (7) in rear area and then clip in at front	MODEL 212.0 (except 212.074/077), 212.1, 212.2 (except 212.274/277) with CODE 279 (Electronic gear selector)	
16	Insert audio/COMAND operating unit (A40/9) into center cover (4) and screw in bolts (30)	MODEL 212.0 (except 212.074/077), 212.1, 212.2 (except 212.274/277) as of model year 2014 with CODE 279 (Electronic gear selector) MODEL 218 (except 218.374/375/376/392/974/975/976/992) as of model year 2015 When replacing center cover (4).	
17	Clip automatic transmission mode button (S16/12) into center cover (4)	MODEL 212.0 (except 212.074/077), 212.1, 212.2 (except 212.274/277) as of model year 2014 with CODE 279 (Electronic gear selector) MODEL 218 (except 218.374/375/376/392/974/975/976/992) as of model year 2015 When replacing center cover (4).	
18	Clip suspension button group (S77) into center cover (4)	MODEL 212.0 (except 212.074/077), 212.1, 212.2 (except 212.274/277) as of model year 2014 with CODE 279 (Electronic gear selector) with CODE 489 (AIRMATIC) MODEL 218 (except 218.374/375/376/392/974/975/976/992) as of model year 2015 with CODE 489 (AIRMATIC) When replacing center cover (4).	
19	Clip cover for button group (5) into center cover (4)	MODEL 212.0 (except 212.074/077), 212.1, 212.2 (except 212.274/277) up to model year 2014 with CODE 279 (Electronic gear selector) MODEL 218 (except 218.374/375/376/392/974/975/976/992) up to model year 2015 When replacing center cover (4).	
20	Connect electrical connector (25) to suspension button group (S77)	MODEL 212.0 (except 212.074/077), 212.1, 212.2 (except 212.274/277) with CODE 279 (Electronic gear selector) with CODE 489 (AIRMATIC) MODEL 218 (except 218.374/375/376/392/974/975/976/992) with CODE 489 (AIRMATIC)	
21	Connect electrical connector (24) to automatic transmission mode button (S16/12)		
22	Connect electrical connector (26) to audio/COMAND operating unit (A40/9)	MODEL 212.0 (except 212.074/077), 212.1, 212.2 (except 212.274/277) as of model year 2014 with CODE 279 (Electronic gear selector) MODEL 218 (except 218.374/375/376/392/974/975/976/992) as of model year 2015	
23	Install center cover (4)		
24	Install lock cover (21) on lock (arrow H), push locks (23) toward inside with feeler gauge (04) and then push lock cover (21) downward and arrest with lock	 If required apply light subsequent pressure on lock cover (21) (arrow G).  Feeler gauge	*129589032100
25	Slightly lift lock (arrow I) in front area and slide release handle cover (3) to lock (arrow J)		
26	Close rear stowage compartment (2)		

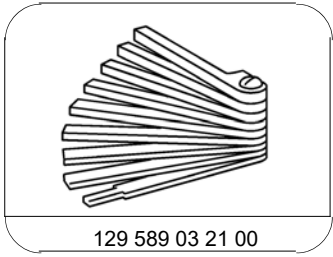

129 589 03 21 00

Feeler gauge

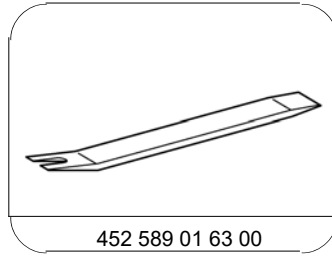

452 589 01 63 00

Clip remover

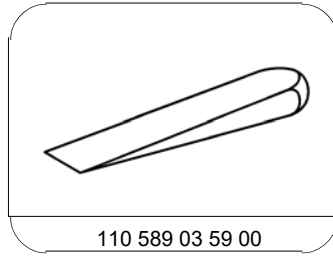

110 589 03 59 00

Mounting wedge