

Model 204, 207, 212, 218

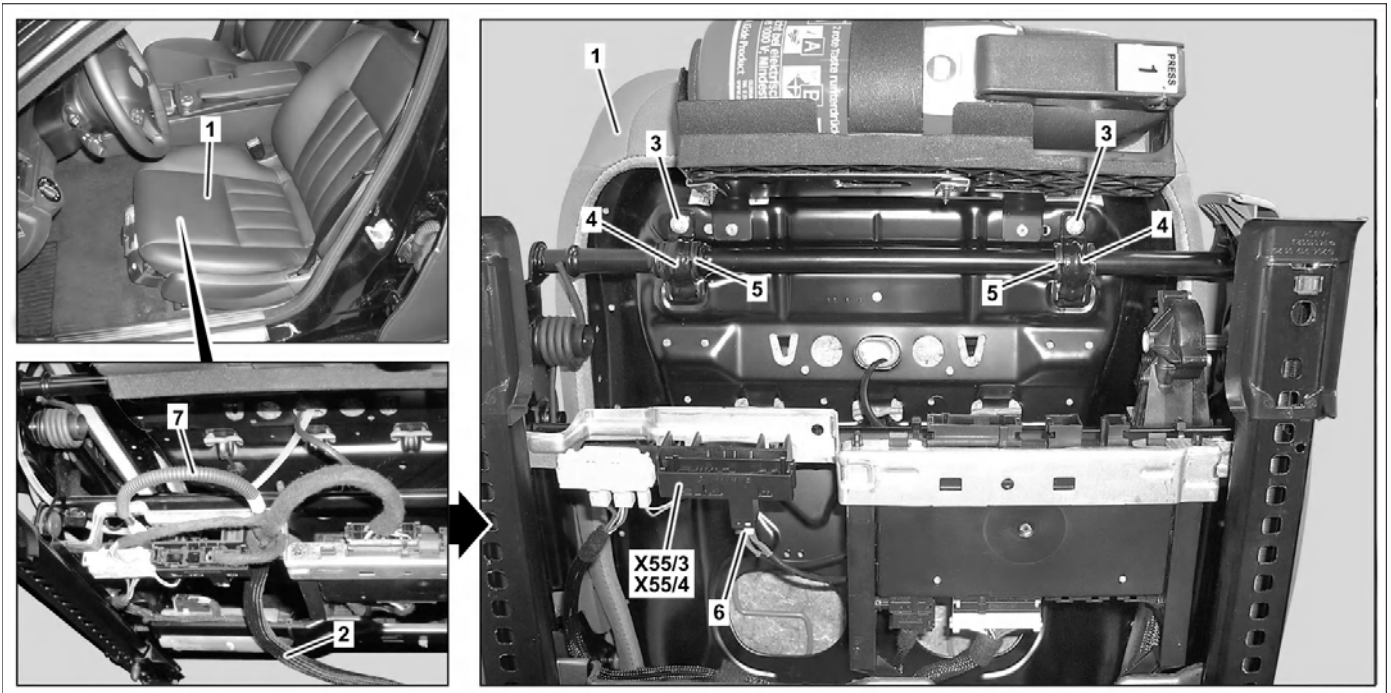

P91.10-3252-09

Shown on MODEL 204.0 with CODE 409 (Left/right front multicontour seats) and CODE 873 (Seat heater for driver and front passenger)

- | | | | |
|---|---------------------------|-------|---------------------------------------|
| 1 | Seat cushion | 6 | Electrical connector for seat heaters |
| 2 | Electrical wiring harness | 7 | Pneumatic line |
| 3 | Screw | X55/3 | Driver seat connector block |
| 4 | Bow | X55/4 | Front passenger seat connector block |
| 5 | Bearing shell | | |

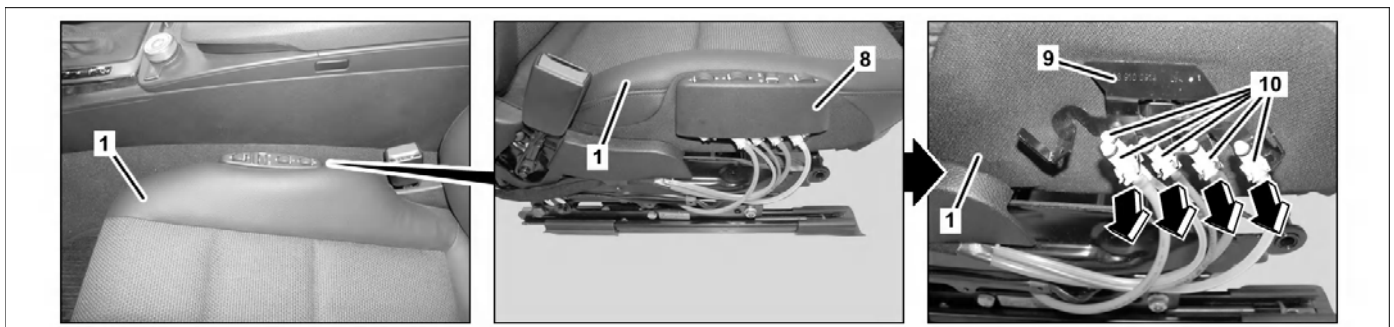

P91.10-3253-07

MODEL 204.0/2/3 (except 204.077/277), 207, 212, 218 with CODE 409 (Left/right front multicontour seat), shown on left front seat

- | | | | |
|---|---------------|----|-----------------|
| 1 | Seat cushion | 9 | Bracket |
| 8 | Control valve | 10 | Pneumatic lines |

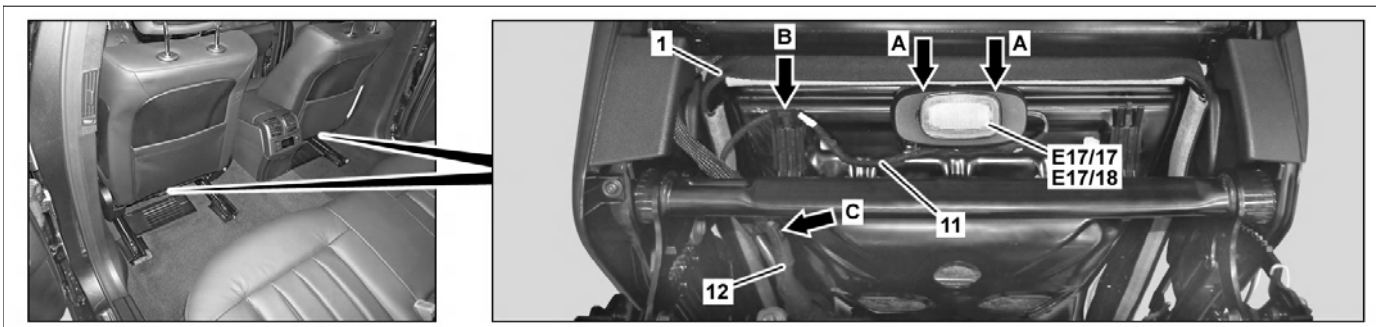

P91.10-3457-07

MODEL 218, 212 with CODE 954 (Avantgarde) or with CODE 955 (Elegance)

- | | | | |
|----|---------------------------|--------|--------------------------|
| 1 | Seat cushion | E17/17 | Left rear footwell lamp |
| 11 | Electrical wiring harness | E17/18 | Right rear footwell lamp |
| 12 | Electrical wiring harness | | |

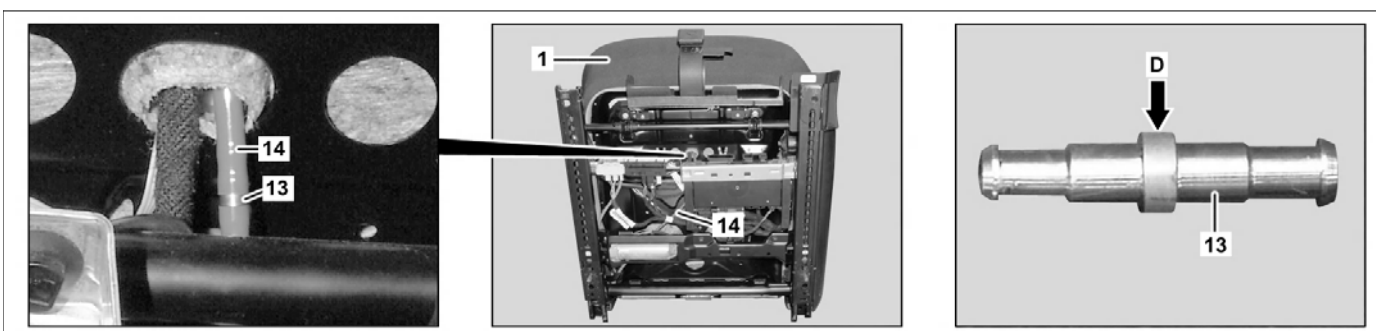









P91.25-2511-07

MODEL 212, MODEL 218 up to model year 2015 with CODE 432 (Left/right dynamic multicontour seat)

- | | | | | | |
|---|--------------|----|-----------------|----|----------------|
| 1 | Seat cushion | 13 | Terminal blocks | 14 | Pneumatic line |
|---|--------------|----|-----------------|----|----------------|

	Information on preventing damage to electronic components due to electrostatic discharge		AR54.00-P-0001-01A
	Remove/install		
1	Remove the fire extinguisher from the bracket	Model 218 with code 682 (Fire extinguisher)	
2.1	Move the seat all the way back and fold the front and rear seat cushions (1) all the way up	Model 204 except code 873 (Seat heating for driver and front passenger) except code 932 (Stowage box under both front seats) Model 207, 212, 218 except code 873 (Seat heating for driver and front passenger)	
2.2	Remove seat	Model 204 with code 932 (Stowage box under both front seats)	AR91.10-P-1000CW
2.3	Release seat and tilt backwards with lines connected and seat belt installed	Model 204 (except 204.9), 207, 212, 218 with code 873 (Seat heating for driver and front passenger) Model 218 with code 873 (Seat heating for driver and front passenger) Move backrest to rear.	AR91.10-P-1000CW
3	Disconnect ground line from battery	Model 204 Model 207, 212, 218	AR54.10-P-0003CW AR54.10-P-0003EW

4	Remove stowage box under seat	Model 204 with code 932 (Stowage box under both front seats)	
5	Expose electrical wiring harness (2) at seat adjustment unit and disconnect at driver seat connector block (X55/3) or front passenger seat connector block (X55/4)		
6	Disconnect pneumatic line (7) from bottom of seat adjustment unit	Model 204 (except 204.9), 207, 212, 218 with code 409 (Left/right front multicontour seat) Model 212, 218 with code 432 (Left and right dynamic multicontour seat)  Pliers	*000589043700
7	Remove the switch group for the dynamic seat	Model 212 up to model year 2014 with code 432 (Left and right dynamic multicontour seat) Model 218 up to model year 2015 with code 432 (Left and right dynamic multicontour seat)	AR91.25-P-1820EW
8	Remove control valve (8)	Model 204 (except 204.077/277/9), 207, 212, 218 with code 409 (Left/right front multicontour seat)	AR91.25-P-1710CW
9	Unclip pneumatic lines (10) from bracket (9)	Model 204 (except 204.077/277/9), 207, 212, 218 with code 409 (Left/right front multicontour seat)  Installation: Ensure correct routing and attachment of pneumatic lines (10).	
10	Expose pneumatic lines (10) at bottom of seat cushion (1)	Model 204 (except 204.077/277/9), 207, 212, 218 with code 409 (Left/right front multicontour seat)	
11	Unclip driver seat connector block (X55/3) or front passenger seat connector block (X55/4) and turn to one side until seat heater electrical connector (6) can be disconnected	Model 204, 207, 212, 218 with code 873 (Seat heating for driver and front passenger)	
12	Disconnect seat heater electrical connector (6) from driver seat connector block (X55/3) or front passenger seat connector block (X55/4)	Model 204, 207, 212, 218 with code 873 (Seat heating for driver and front passenger)	
13	Fold housing halves of seat heater electrical connector coupling (6) away from one other	Model 204, 207, 212, 218 with code 873 (Seat heating for driver and front passenger)	
14	Disconnect seat occupied recognition electrical connector at front passenger seat connector block (X55/4)	When removing the seat cushion (1) at the passenger side.	
15	Raise seat cushion (1) at rear and unclip left rear footwell lamp (E17/17) or right rear footwell lamp (E17/18) at seat cushion (1) (arrows A)	Model 212, 218 with code 954 (Avantgarde) Model 212, 218 with code 955 (Elegance)	
16	Unclip electrical wiring harness (11) at seat cushion (1) from bracket (arrow B)	Model 212, 218 with code 954 (Avantgarde) Model 212, 218 with code 955 (Elegance)	
17	Unclip electrical wiring harness (12) at bottom of seat cushion (1) (arrow C)	Model 212	
18	Expose electrical lines belonging to seat cushion (1) at seat adjustment unit	 The number of electrical lines varies depending on the vehicle equipment.  Observe routing and mounting of electrical lines.	
19.1	Cut through pneumatic line (14) below seat cushion (1) at an easily accessible location	Model 212 with code 432 (Left and right dynamic multicontour seat) Model 218 up to model year 2015 with code 432 (Left and right dynamic multicontour seat)  Do not disconnect the pneumatic line (14) at an existing terminal block (13). Otherwise, leaks can occur at the pneumatic line (14).	

		<p>i Installation: Connect pneumatic line (14) as shown using a terminal block (13). Slide both sides of pneumatic line (14) up to collar (arrow D) onto terminal block (13).</p> <p> Knife</p>	*000589122800
19.2	Disconnect pneumatic line (14) below seat cushion (1) at factory connecting point	Model 218 as of model year 2015 with code 432 (Left and right dynamic multicontour seat)	
20	Remove bolts (3)		
21	Fold out and remove bracket (4)		
22	Fold up bearing shells (5)		
23	Remove seat cushion (1)		
24	Install in the reverse order		
	Initial startup		
25	Carry out initial startup of weight sensing system (WSS)	Model 204, 207, 212, 218 with code 494 (US version) with code U10 (Automatic seat occupancy recognition and child seat recognition) When removing the seat cushion (1) at the passenger side.	AD00.00-P-2000-04A *211589003200
	 AD	 Plates	

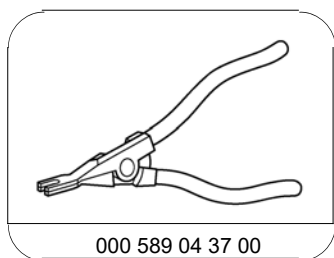

000 589 04 37 00

Pliers

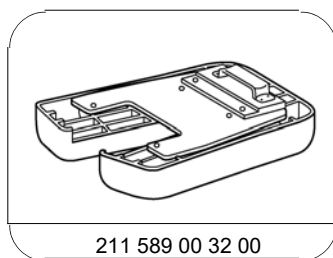

211 589 00 32 00

Plates

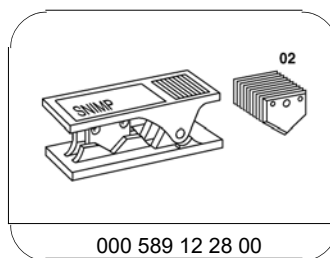

000 589 12 28 00

Knife