

Model 117, 156, 172.4, 176, 190, 204.3, 218, 231, 242, 246

Model 204.0/2, 207, 212
as of model year 2012

Model 204.9
as of model year 2013

Shown on model 218

- 1 Driver airbag
- 2 Steering wheel

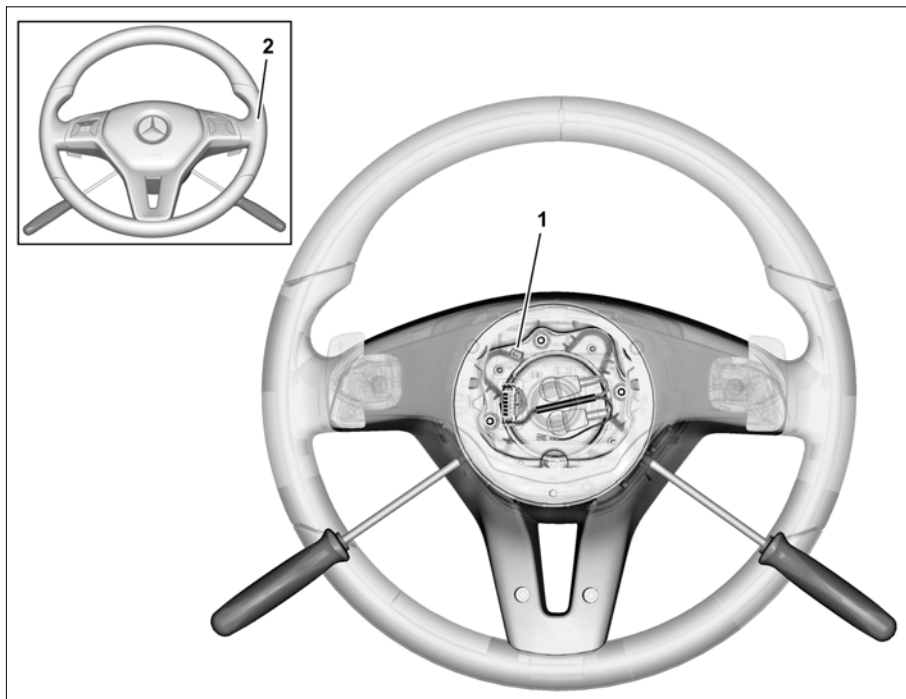

P91.60-4159-06





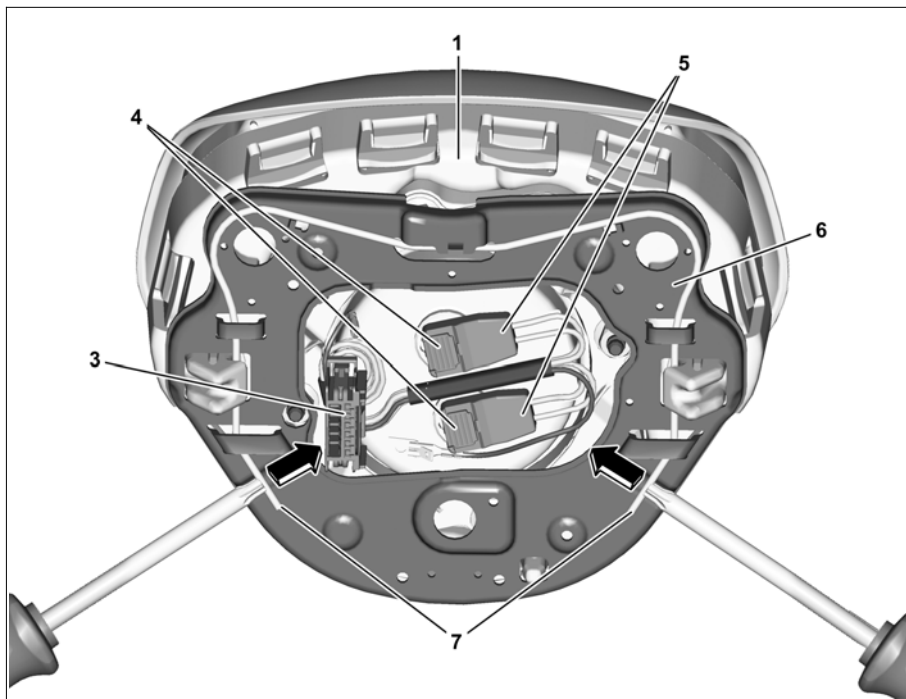

Shown on model 218

- 1 Driver airbag
- 3 Connector
- 4 Lock tabs
- 5 Electrical connectors
- 6 Retaining plate
- 7 Retaining springs



P91.60-4158-06

<p>⚠ Danger !</p>	<p>Risk of injury during testing and repair operations related to pyrotechnical components</p>	<p>Do not expose pyrotechnical components to temperatures above 100 °C or 212 °F. Disconnect current supply when working on such components.</p>	<p>AS91.00-Z-0008-01A</p>
<p>⚡</p>	<p>Information on preventing damage to electronic components due to electrostatic discharge</p>		<p>AH54.00-P-0001-01A</p>

	Information, assessment and legal requirements when working with, handling and storing pyrotechnical components		AH91.00-Z-0000-10A
	Remove/install		
1	Place steering column in the central height position		
2	Switch on ignition and store transmitter key outside of transmission range (min. 2 m)		
3	Disconnect ground line to battery	Model 172 Model 204.0/2 as of model year 2012 Model 204.3 Model 204.9 as of model year 2013 Model 207, 212 as of model year 2012 Model 218 Model 231 Model 117, 156, 176, 242, 246 Model 190	AR54.10-P-0003W AR54.10-P-0003CW AR54.10-P-0003EW AR54.10-P-0003RK AR54.10-P-0003NKB AR54.10-P-0003RG
4	Determine position of openings through careful application of the Torx screwdriver of size T20	When removing driver airbag (1) for first time.	
5	Pierce openings using Torx screwdriver of size T20	When removing driver airbag (1) for first time.	
6	Insert Torx screwdriver into openings on steering wheel (2) and press retaining springs (7) inward	 Installation: The retaining springs (7) must latch audibly into the driver airbag (1). Otherwise, the driver airbag (1) may work its way loose from the steering wheel (2).	
7	Remove driver airbag (1) far enough from steering wheel (2) until the connector (3) is accessible		
8	Release and disconnect connector (3) from steering column tube module		
9	Remove driver airbag (1) from steering wheel (2)		
10	Install in the reverse order		
	Check		
 	Check and erase vehicle fault memory using the diagnostic system	When replacing the driver airbag (1). Model 117, 156, 172.4, 176, 204.3, 218, 231, 242, 246 Model 204.0/2, 207, 212 as of model year 2012 Model 204.9 as of model year 2013 Model 190	AD00.00-P-2000-04A AD00.00-P-2000-04B