

MODEL 207.4
 as of model year 2014
 without CODE 427 (7-speed automatic transmission)

MODEL 207.4
 up to model year 2014

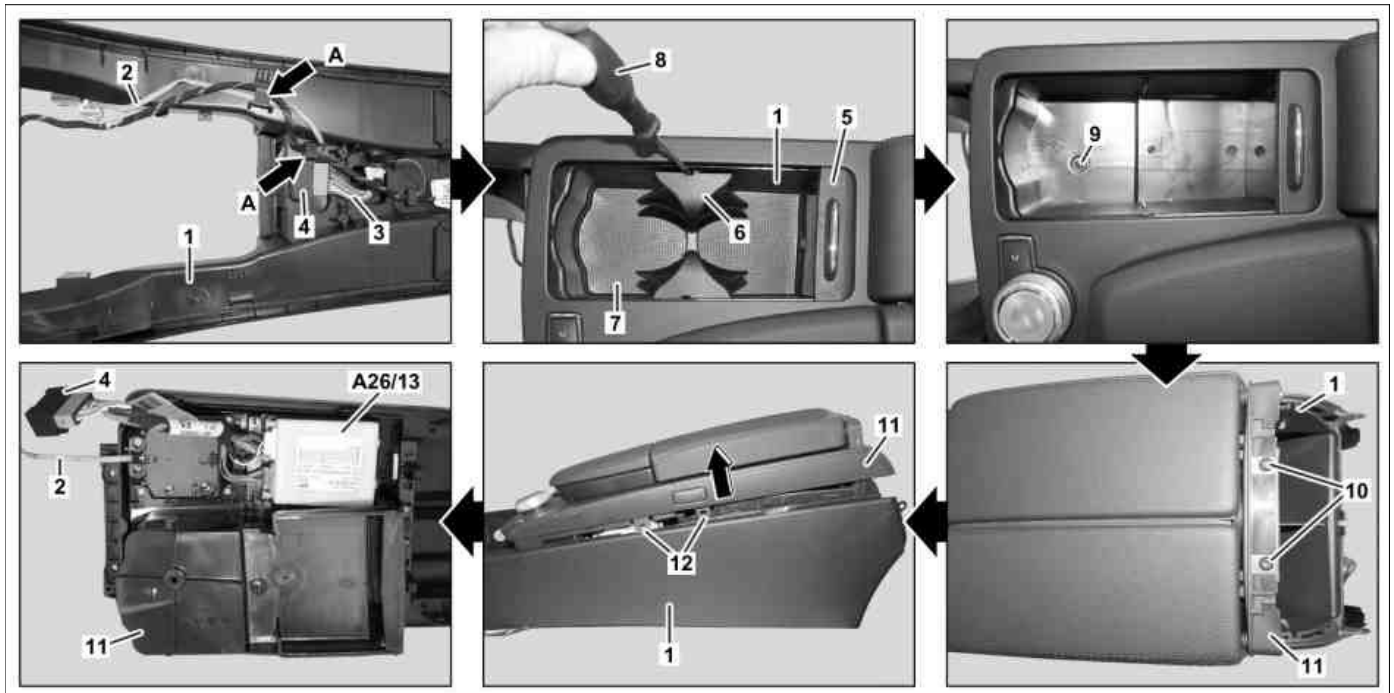

P68.20-4261-09

- | | | | | | |
|---|---------------------------|----|-------------------|--------|---|
| 1 | Center console | 6 | Beverage holder | 11 | Armrest |
| 2 | Electrical wiring harness | 7 | Insertion element | 12 | Lugs |
| 3 | Electrical wiring harness | 8 | Screwdriver | A26/13 | Interior protection sensor (master)
(with CODE (882) Interior monitoring (only with ATA only)) |
| 4 | Electrical connector | 9 | Screw | | |
| 5 | Roller blind | 10 | Bolts | | |

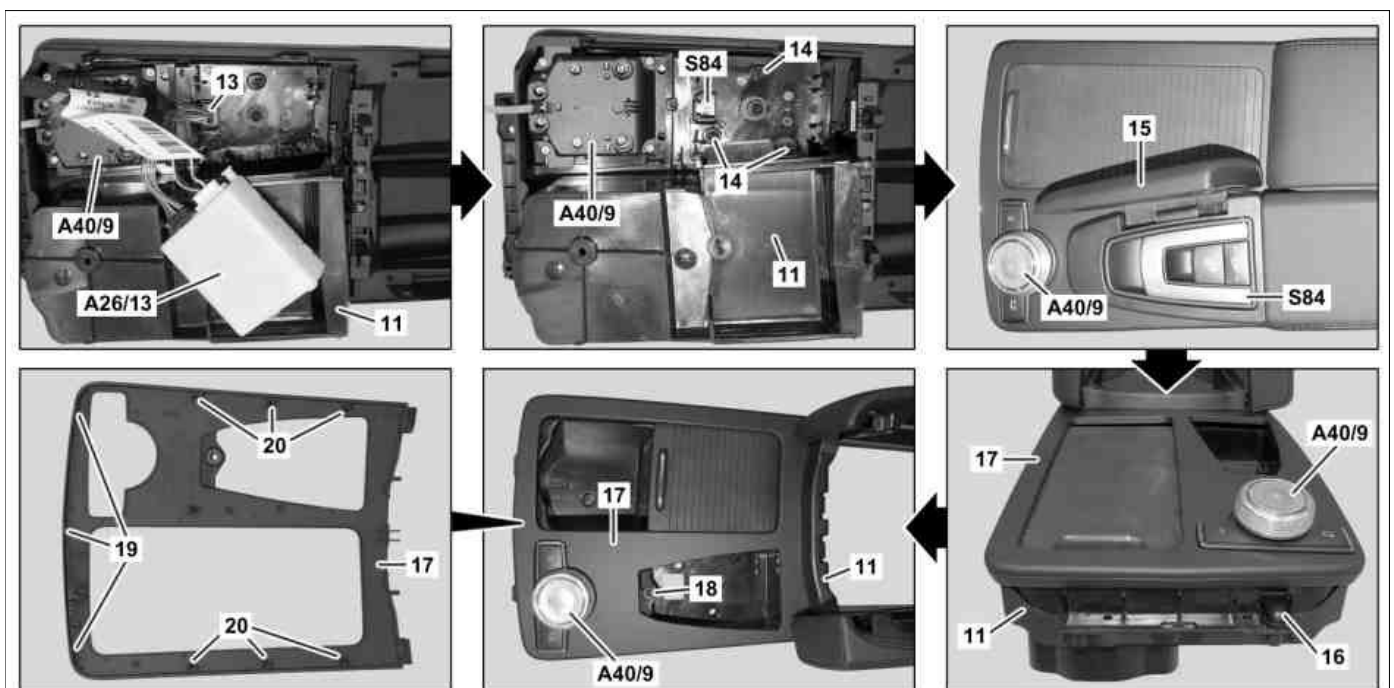

11	Armrest	16	Screw	20	Side catch hook
13	Electrical connector	17	Cover	A26/13	Interior protection sensor (master) (with CODE (882) Interior monitoring (only with ATA only)
14	Bolts	18	Screw	A40/9	Audio/COMAND control panel
15	Support	19	Front catch hook	S84	Soft top control switch

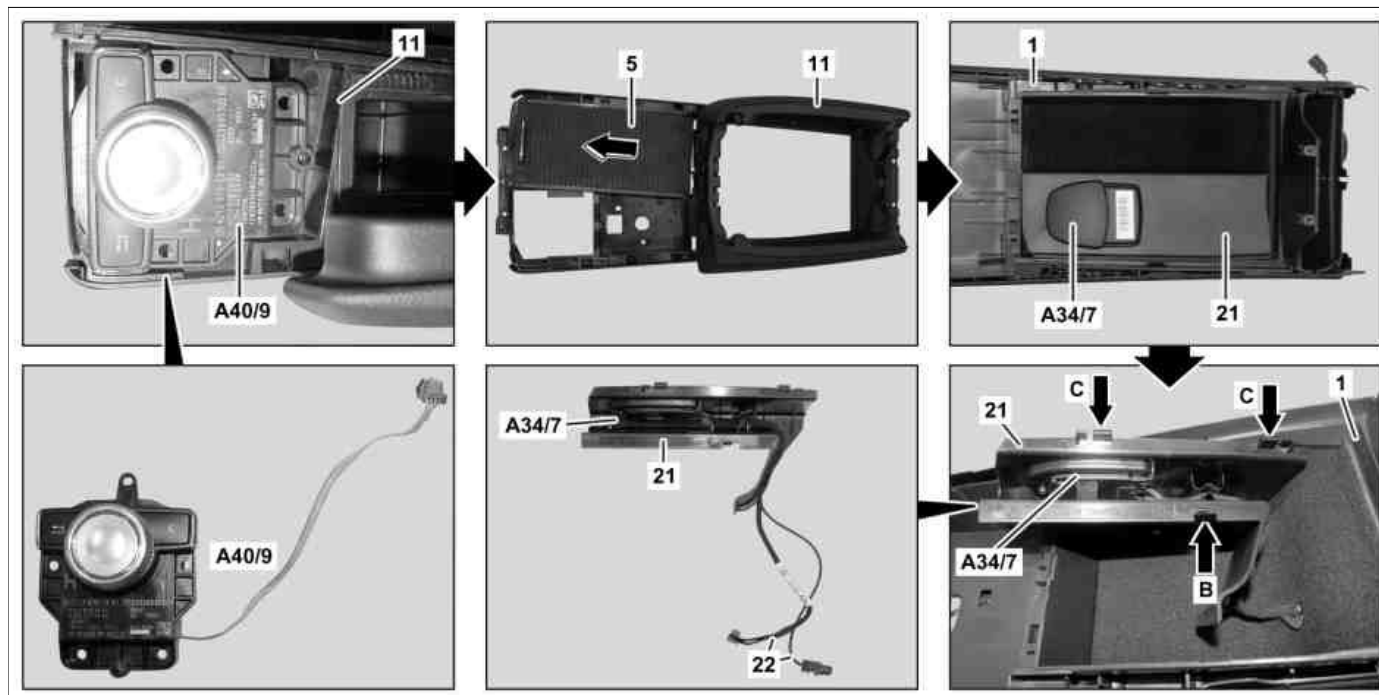

Shown on vehicle up to 28.02.2011 with code (386) Comfort telephony

1	Center console	21	Mounting console (on vehicles up to 28.02.2011 with CODE 386 (Comfort telephony))	A40/9	Audio/COMAND control panel
5	Roller blind	22	Electrical lines (with CODE 386 (Comfort telephony))		
11	Armrest	A34/7	Bluetooth module (with CODE 386 (Comfort telephony))		

Shown on vehicle as of 01.03.2011 with code (386) Comfort telephony

- 1 Center console
- 22 Electrical lines (with CODE 386 (Comfort telephony))
- 23 Long wedge
- 25 Catch hook
- 39 Mounting console (pivotable) (on vehicles as of 01.03.2011 with code (386) Comfort telephony)
- 40 Bolt (MODEL 207.4 as of 01.03.11 up to model year 2014 with CODE 386 (Comfort telephony) or CODE 512 (COMAND APS incl. DVD changer) or CODE 518 (Media Interface), MODEL 207.4 as of model year 2014 with CODE 386 (Comfort telephony))
- A34/7 Bluetooth module (with CODE 386 (Comfort telephony))

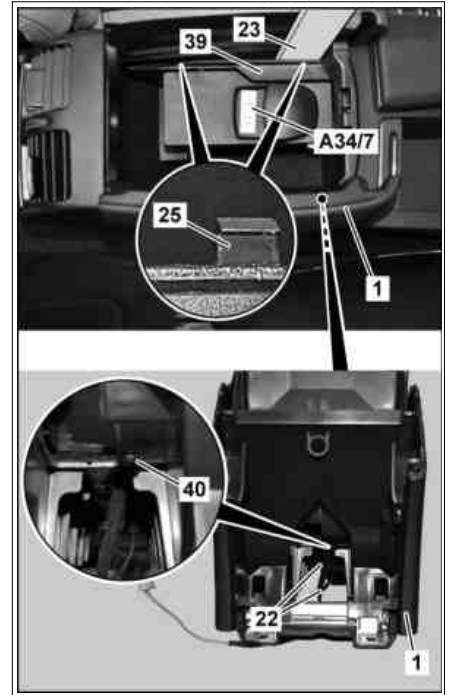

P82.70-7615-03





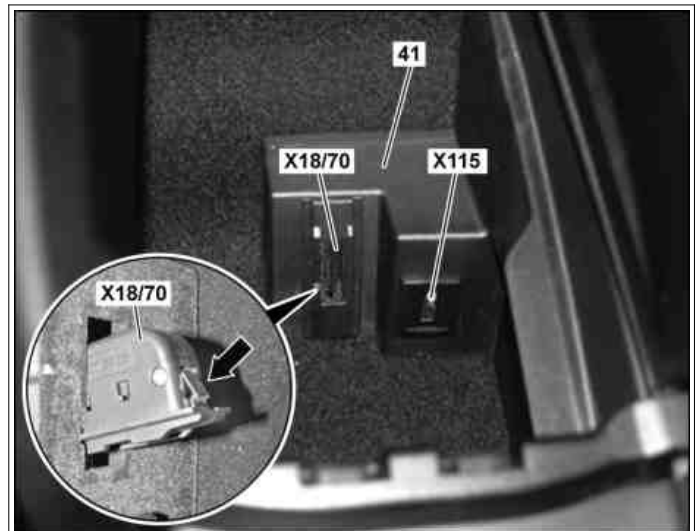



Shown on vehicle as of 01.03.2011 up to model year 2014 without CODE 386 (Comfort telephony)







- 41 connecting strip (up to model year 2014 without CODE 386 (Comfort telephony))
- X18/70 Electrical connector for Media Interface (with CODE 518 (Media Interface))
- X115 USB electrical connector (vehicles as of 01.07.11 up to model year 2014 with CODE 512 (COMAND APS incl. DVD changer) or CODE 526 (COMAND (without navigation)) or CODE 528 (COMAND incl. DVD changer) or CODE 527 (COMAND APS with single DVD drive (with navigation)), Vehicles as of 01.06.12 up to model year 2014 with CODE 510 (Audio 20 CD with CD changer) or CODE 523 (Radio MB Audio 20), Vehicles as of model year 2014)



P82.70-7616-11

↙ ↘	↙ ↘	Disassemble/assemble		
1		Remove center console (1)		AR68.20-P-2000CW
2		Lay center console (1) down with bottom up	⚠	Lay center console (1) down on clean dry cloth. Otherwise damage may occur.
3		Unclip connector on electrical wiring harness (2) from center console (1) and expose electrical wiring harness (2) on center console (1) (arrows A)		
4		Unclip electrical connector (4) from center console (1)		
5		Lay center console (1) with top up	⚠	Lay center console (1) down on clean dry cloth. Otherwise damage may occur.
6		Slide roller blind (5) toward rear		
7		Unclip beverage holder (6) as shown from center console (1) with screwdriver (8) on both sides in area of cutouts for beverage holder (6) and remove upward		
8		Remove insertion element (7)		
9		Unscrew screw/bolt (9)		

10	Remove bolts (10)	 Installation: Carefully tighten bolts (10). Otherwise the center console (1) can be damaged and must be replaced.	
11	Unclip armrest (11) on lugs (12) on left and right side of center console (1), guide out upward and remove	 Carefully unclip armrest (11). Otherwise the lugs (12) can break off.  Installation: Make sure that electrical lines are not pinched. Otherwise the vehicle electrical system may be damaged.  Remove all electrical lines on armrest (11) from center console (1). The number of electrical lines depends on the vehicle equipment.  Mounting wedge	*110589035900
12	Unclip interior protection sensor (master) (A2613) from armrest (11) and lay down to side with electrical wiring harness connected	MODEL 207.4 as of model year 2014 with CODE 882 (Interior monitoring (with ATA [EDW] only)) without CODE 427 (7-speed automatic transmission) MODEL 207.4 up to model year 2014 with CODE 882 (Interior monitoring (with ATA [EDW] only))	
13	Disconnect electrical connector (13)		
14	Remove screws/bolts (14)		
15	Remove covering (15) with soft top control switch (S84) from armrest (11)		
16	Remove screw/bolt (16)		
17	Unscrew screw/bolt (18)		
18	First unclip front catch hooks (19), then side catch hooks (20) and remove cover (17) from armrest (11) toward front	 Carefully unclip cover (17). Otherwise the cover (17) can be damaged and must be replaced.	
19	Lift audio/COMAND control panel (A40/9), remove with electrical wiring harness (2) toward rear from armrest (11)		
20	Pull roller blind (5) toward front out of armrest (11) and remove		
21	Unclip Media Interface electrical connector (X18/70) and guide toward out through opening in connecting strip (41) or mounting console (39)	MODEL 207.4 as of 3/1/11 up to model year 2014 with CODE 512 (COMAND APS with DVD changer) MODEL 207.4 as of model year 2014 with CODE 512 (COMAND APS with DVD changer) without CODE 427 (7-speed automatic transmission)  On vehicles as of model year 2014 the connecting strip (41) will be eliminated. The electrical connector for Media Interface (X18/70) is clipped directly into the housing of the center console (1).	
22	Unscrew bolt (40) at bottom of center console (1) on mounting console mount (39) or connecting strip (41)	MODEL 207.4 as of 3/1/11 up to model year 2014 with CODE 386 (Comfort telephony) MODEL 207.4 as of 3/1/11 up to model year 2014 with CODE 512 (COMAND APS with DVD changer) MODEL 207.4 as of 3/1/11 up to model year 2014 with CODE 518 (Media interface) MODEL 207.4 as of model year 2014 with CODE 386 (Comfort telephony) without CODE 427 (7-speed automatic transmission) MODEL 207.4 as of model year 2014 with CODE 512 (COMAND APS with DVD changer) without CODE 427 (7-speed automatic transmission)  As of model year 2014 the connecting strip (41) will be eliminated.	

23.1	Unclip mounting console (21) at bottom (arrow B), pivot toward inside and unclip at top (arrows C)	MODEL 207.4 up to 2/28/11 up to model year 2014 with CODE 386 (Comfort telephony)  Long wedge	*115589035900
23.2	Unclip mounting console (39) with long wedge (23) from center console (1)	MODEL 207.4 as of 3/1/11 up to model year 2014 with CODE 386 (Comfort telephony) MODEL 207.4 as of model year 2014 with CODE 386 (Comfort telephony) without CODE 427 (7-speed automatic transmission)  Carefully unclip mounting console (39). Otherwise the catch hooks (25) can break and the mounting console (39) must be replaced.  Long wedge	*115589035900
24	Unclip connecting strip (41) with long wedge (23) from center console (1) and remove	MODEL 207.4 as of 3/1/11 up to model year 2014 with CODE 512 (COMAND APS with DVD changer) without CODE 386 (Comfort telephony) MODEL 207.4 up to 3/1/11 up to model year 2014 with CODE 518 (Media interface) without CODE 386 (Comfort telephony) MODEL 207.4 as of model year 2014 with CODE 512 (COMAND APS with DVD changer) without CODE 386 (Comfort telephony) without CODE 427 (7-speed automatic transmission) MODEL 207.4 as of model year 2014 with CODE 518 (Media interface) without CODE 386 (Comfort telephony) without CODE 427 (7-speed automatic transmission)  Carefully unclip connecting strip (41). Otherwise the catch hooks can break and the connecting strip (41) must be replaced.  The catch hook on the connecting strip (41) is located at the same location as the catch hook (25) of the mounting console (39).  Long wedge	*115589035900
25	Unclip USB electrical connector USB (X115) from connecting strip (41) or housing from center console (1) and remove	MODEL 207.4 as of 6/1/12 up to model year 2014 with CODE 510 (Audio 20 CD with CD changer) MODEL 207.4 as of 6/1/12 up to model year 2014 with CODE 523 (MB Audio 20 radio) MODEL 207.4 as of 7/1/11 up to model year 2014 with CODE 512 (COMAND APS with DVD changer) MODEL 207.4 as of 7/1/11 up to model year 2014 with CODE 526 (COMAND (without navigation)) MODEL 207.4 as of 7/1/11 up to model year 2014 with CODE 527 (COMAND APS with single DVD drive (with navigation)) MODEL 207.4 as of 7/1/11 up to model year 2014 with CODE 528 (COMAND with DVD changer) MODEL 207.4 as of model year 2014 without CODE 427 (7-speed automatic transmission)  On vehicles as of model year 2014 the connecting strip (41) will be eliminated. The USB electrical connector(X115) is directly clipped into the housing of center console (1)	

26.1	Guide mounting console (21) with Bluetooth module (A347) and electrical lines (22) out of center console (1) and remove	MODEL 207.4 up to 2/28/11 up to model year 2014 with CODE 386 (Comfort telephony)	
26.2	Guide mounting console (39) with Bluetooth module (A347) and electrical lines (22) out of center console (1) and remove	MODEL 207.4 as of 3/1/11 up to model year 2014 with CODE 386 (Comfort telephony) MODEL 207.4 as of model year 2014 with CODE 386 (Comfort telephony) without CODE 427 (7-speed automatic transmission)	
27	Assemble in the reverse order		

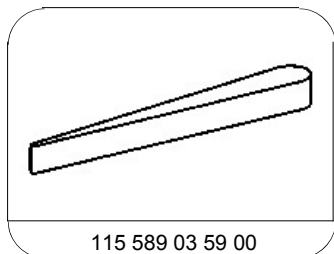

Long wedge

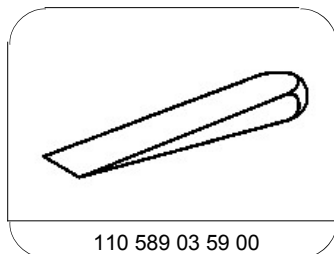

Mounting wedge