

MODEL 204.0/2
 MODEL 204.3
 without CODE P98 (Black Series)
 MODEL 207
 up to model year 2014
 MODEL 212
 up to model year 2014

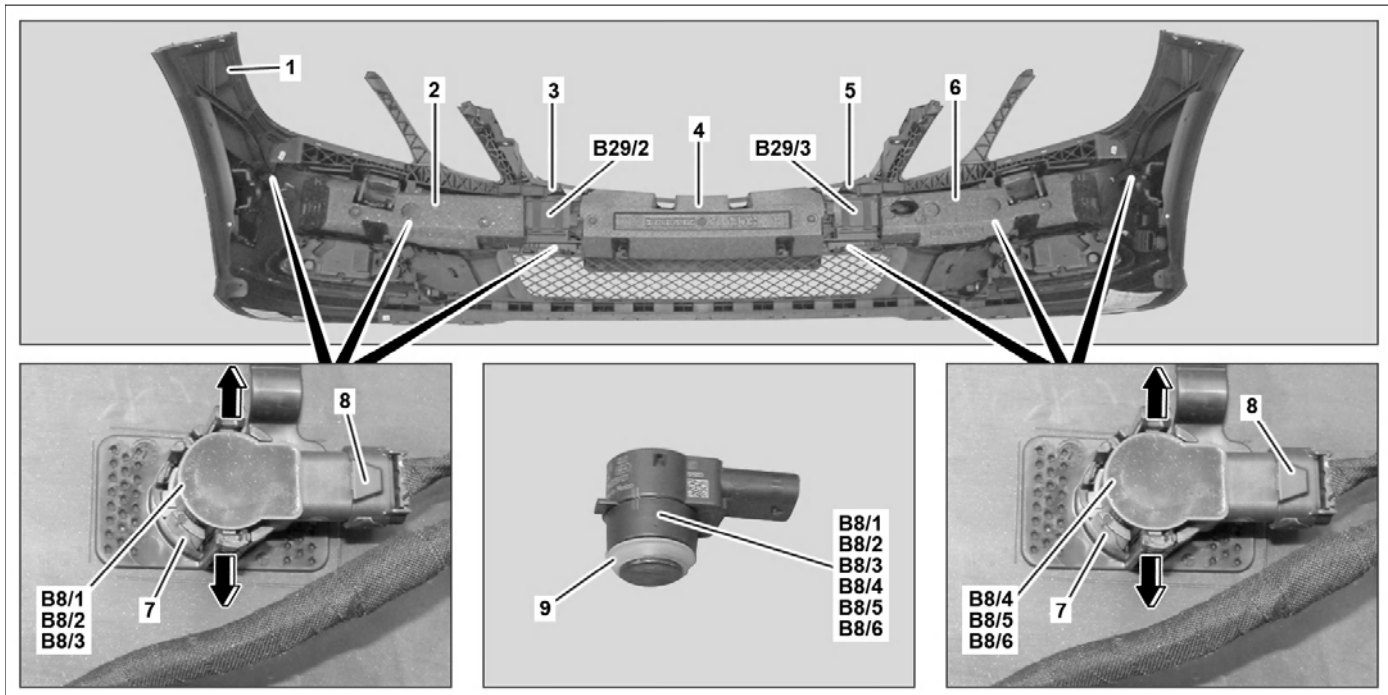

P88.20-4122-09

Shown on MODEL 207 with CODE 220 (PARKTRONIC) and CODE 233 (DISTRONIC PLUS)

1	Front bumper	7	Bracket (with CODE 220 (PARKTRONIC) or CODE 230 (Exclusive parking assist))	B8/2	Left left front parking assist distance sensor (with CODE 220 (PARKTRONIC) or CODE 230 (Exclusive parking assist))
2	Left impact damper	8	Electrical connector (with CODE 220 (PARKTRONIC) or CODE 230 (Exclusive parking assist))	B8/3	Inner left front parking assist distance sensor (with CODE 220 (PARKTRONIC) or CODE 230 (Exclusive parking assist))
3	Bracket (with CODE 233 (DISTRONIC PLUS))	9	Seal (with CODE 220 (PARKTRONIC) or CODE 230 (Exclusive parking assist))	B8/4	Inner right front parking assist distance sensor (with CODE 220 (PARKTRONIC) or CODE 230 (Exclusive parking assist))
4	Center impact damper	B29/2	DISTRONIC sensor (DTR) Left front bumper (with CODE 233 (DISTRONIC PLUS))	B8/5	Center right front parking assist distance sensor (with CODE 220 (PARKTRONIC) or CODE 230 (Exclusive parking assist))
5	Bracket (with CODE 233 (DISTRONIC PLUS))	B29/3	Right front bumper DISTRONIC (DTR) sensor (with code (233) DISTRONIC PLUS)	B8/6	Outer right parking assist distance sensor (with CODE 220 (PARKTRONIC) or CODE 230 (Exclusive parking assist))
6	Right impact damper	B8/1	Outer left front parking assist distance sensor (with CODE 220 (PARKTRONIC) or CODE 230 (Exclusive parking assist))		

Shown on MODEL 207 with CODE 600 (Headlamp cleaning system) and CODE U60 (Pedestrian protection)

- 1 Front bumper
- 10 Left telescopic nozzle cover (with CODE 600 (Headlamp cleaning system))
- 11 Electrical wiring harness
- 12 Towing eye cover
- 13 Right telescopic nozzle cover (with CODE 600 (Headlamp cleaning system))
- 14 Right cover
- 15 Bottom basic carrier
- 16 Air grille
- 17 Left cover
- B151/1 Left front bumper pedestrian protection sensor (with CODE U60 (Pedestrian protection))
- B151/3 Right front bumper pedestrian protection sensor (with CODE U60 (Pedestrian protection))

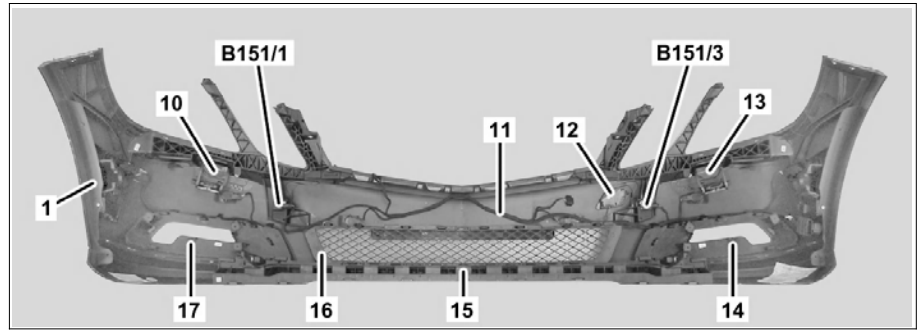



P88.20-3385-04

Shown on MODEL 212 on left side of vehicle, with CODE 955 (Elegance)

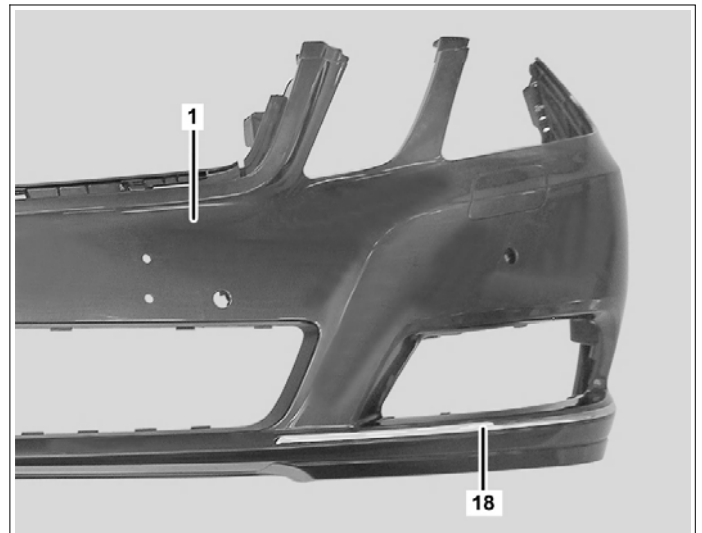
- 1 Front bumper
- 18 Trim strip (MODEL 204.0/2 with CODE 954 (Avantgarde) or CODE 955 (Elegance), MODEL 204.3 with CODE 900 (Chrome package, exterior), MODEL 207, MODEL 212 with CODE 955 (Elegance))



P88.20-3386-11

	Remove/install		
1	Remove front bumper (1)	MODEL 207 up to model year 2014 MODEL 212 up to model year 2014 MODEL 204.0/2 MODEL 204.3 without CODE P98 (Black Series)  On MODEL 207 remove radiator grille from front bumper (1).	AR88.20-P-2000EW AR88.20-P-2000CW
	Unclip left impact absorber (2), right impact absorber (6) and center impact absorber (4) from front bumper (1) General information on the impact absorber		AH88.20-P-1000-01A
3	Disconnect electrical connector from left front bumper DISTRONIC (DTR) sensor (B29/2) and right front bumper DISTRONIC (DTR) sensor (B29/3)	MODEL 204.0/2 with CODE 233 (DISTRONIC PLUS) MODEL 204.3 with CODE 233 (DISTRONIC PLUS) without CODE P98 (Black Series) MODEL 207 up to model year 2014 with CODE 233 (DISTRONIC PLUS) MODEL 212 up to model year 2014 with CODE 233 (DISTRONIC PLUS)	

4	Unclip bracket (3, 5) from front bumper (1)	<p>MODEL 204.0/2 with CODE 233 (DISTRONIC PLUS) MODEL 204.3 with CODE 233 (DISTRONIC PLUS) without CODE P98 (Black Series) MODEL 207 up to model year 2014 with CODE 233 (DISTRONIC PLUS) MODEL 212 up to model year 2014 with CODE 233 (DISTRONIC PLUS)</p> <p>i Removal: Unclip brackets (3, 5) together with left front bumper DISTRONIC (DTR) sensor (B29/2) and right front bumper DISTRONIC (DTR) sensor (B29/3).</p>	
5	Remove left front bumper DISTRONIC (DTR) sensor (B29/2) from bracket (3)	<p>MODEL 204.0/2 with CODE 233 (DISTRONIC PLUS) MODEL 204.3 with CODE 233 (DISTRONIC PLUS) without CODE P98 (Black Series) MODEL 207 up to model year 2014 with CODE 233 (DISTRONIC PLUS) MODEL 212 up to model year 2014 with CODE 233 (DISTRONIC PLUS)</p> <p>When replacing bracket (3) or left front bumper DISTRONIC (DTR) sensor (B29/2).</p>	
6	Remove right front bumper DISTRONIC (DTR) sensor (B29/3) from bracket (5)	<p>MODEL 204.0/2 with CODE 233 (DISTRONIC PLUS) MODEL 204.3 with CODE 233 (DISTRONIC PLUS) without CODE P98 (Black Series) MODEL 207 up to model year 2014 with CODE 233 (DISTRONIC PLUS) MODEL 212 up to model year 2014 with CODE 233 (DISTRONIC PLUS)</p> <p>When replacing bracket (5) or right front bumper DISTRONIC (DTR) sensor (B29/3).</p>	
7	Remove front parking system distance sensors (B8/1, B8/2, B8/3, B8/4, B8/5, B8/6) from brackets (7) and disconnect electrical connectors (8)	<p>MODEL 204.0/2 with CODE 220 (PARKTRONIC) MODEL 204.0/2 with CODE 230 (Advanced Parking Guidance) MODEL 204.3 with CODE 220 (PARKTRONIC) without CODE P98 (Black Series) MODEL 204.3 with CODE 230 (Advanced Parking Guidance) without CODE P98 (Black Series) MODEL 207 up to model year 2014 with CODE 220 (PARKTRONIC) MODEL 207 up to model year 2014 with CODE 230 (Advanced Parking Guidance) MODEL 212 up to model year 2014 with CODE 220 (PARKTRONIC) MODEL 212 up to model year 2014 with CODE 230 (Advanced Parking Guidance)</p> <p>i Installation: Check sealing ring (9), replace if necessary. If, on MODEL 204.077/277/377 and MODEL 212.077/277 the inner left front parking system distance sensor (B8/3) inner right front parking system distance sensor (B8/4) are to be replaced, paint to match appearance of car (color code 9979).</p>	
8	Remove left front bumper pedestrian protection sensor (B1511) and right front bumper pedestrian protection sensor (B1513)	<p>MODEL 204.3 with CODE U60 (Pedestrian protection) without CODE P98 (Black Series) MODEL 207 up to model year 2014 with CODE U60 (Pedestrian protection) MODEL 212 up to model year 2014 with CODE U60 (Pedestrian protection)</p>	

		i Installation: Pay attention to installation position.	
		Nm Bolt, frontal acceleration sensor to bumper	*BA91.60-P-1012-01M
9	Remove left daytime running lamp and right daytime running lamp or left front fog lamp and right front fog lamp	i Depending on vehicle equipment. i The number of bolts depends on the equipment variant.	
10	Unclip left cover (17) and right cover (14)		
11	Unclip air grate (16)		
12	Unclip electric wiring harness (11) from front bumper (1)		
13	Remove left telescopic nozzle cover (10) and right telescopic nozzle cover (13)	MODEL 204.0/2 with CODE 600 (Headlamp cleaning system) MODEL 204.3 with CODE 600 (Headlamp cleaning system) without CODE P98 (Black Series) MODEL 207 up to model year 2014 with CODE 600 (Headlamp cleaning system) MODEL 212 up to model year 2014 with CODE 600 (Headlamp cleaning system)	
14	Install tow eye cover (12)		
15	Unclip lower basic carrier (15)	S Mounting wedge	*110589035900
16	Unclip left and right trim strip (18) from front bumper (1)	MODEL 204.0/2 with CODE 954 (Avantgarde) MODEL 204.0/2 with CODE 955 (Elegance) MODEL 204.3 with CODE 900 (Exterior Chrome package) without CODE P98 (Black Series) MODEL 207 up to model year 2014 MODEL 212 up to model year 2014 with CODE 955 (Elegance)	
17	Remove license plate		
18	Remove license plate bracket		
19	Install in the reverse order		

Nm Airbag

Number	Designation		MODEL 204.3	MODEL 207
BA91.60-P-1012-01M	Bolt, frontal acceleration sensor to bumper	Nm	4	4

Nm Airbag

Number	Designation		MODEL 212
BA91.60-P-1012-01M	Bolt, frontal acceleration sensor to bumper	Nm	4

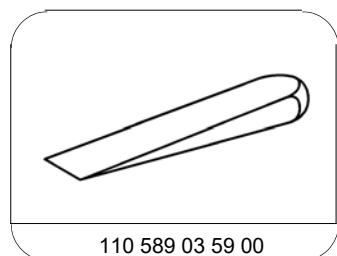

110 589 03 59 00

Mounting wedge