

MODEL 204.3, 207

Outer panel

Shown on model 207 right front seat without code (242) Electrically adjustable front passenger seat with memory function and without code (291) PELVIS AIRBAG (PELVISBAG)

- 1 Outer cover
- 2 Seat cushion
- 3 Hand wheel
(without code (275) Memory package (driver seat, steering column, mirrors) or without code (242) Electrically adjustable front passenger seat with memory)

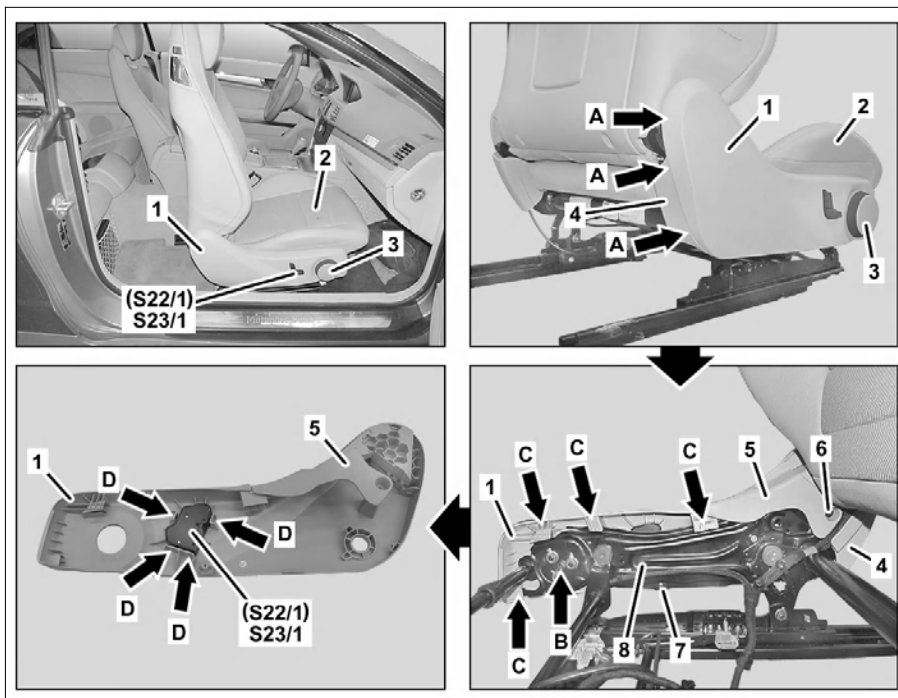

P91.10-3478-06

- 4 Inner cover, bottom
- 5 Inner cover, top
- 6 Screw
- 7 Screw
- 8 Seat frame

S22/1 Driver seat partially electric seat adjustment switch (without code (275) Memory package (driver seat, steering column, mirrors) or without code (242) Electrically adjustable front passenger seat with memory)

S23/1 Front passenger seat partially electric seat adjustment switch (without code (275) Memory package (driver seat, steering column, mirrors) or without code (242) Electrically adjustable front passenger seat with memory)

Shown on model 212 with code (291) PELVIS AIRBAG (PELVISBAG)

- 9 Screw

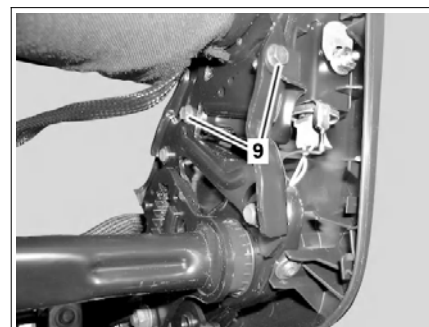

P91.10-3552-01

Shown on model 207 right front seat with code (291) PELVIS AIRBAG (PELVISBAG)



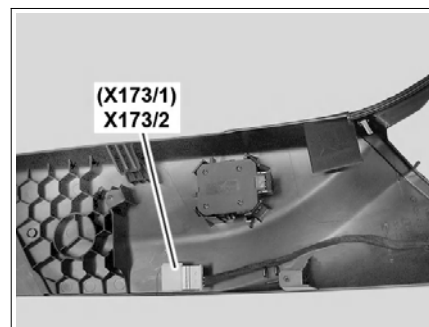











- X173/1 Driver pelvis airbag electrical connector
- X173/2 Front passenger pelvis airbag electrical connector



P91.10-3551-01

Modification notes

23.4.10	Pelvis airbag (pelvisbag) added		
---------	---------------------------------	--	--

 	Remove/install		
	Risk of injury caused by moving parts that can pinch, crush or, in extreme cases, even sever extremities	No parts of the body or limbs should be within the operating range of the mechanism when moving components.	AS00.00-Z-0009-01A
	Risk of injury caused by performing testing or repair work on airbag or emergency tensioning retractor units	Store airbag units with deployment side facing up; do not expose to temperatures greater than 100 °C. When working on these units, disconnect the power supply.	AS91.00-Z-0001-01A
	Notes on performing repair, body work and welding on vehicles with airbags or emergency tensioning retractor units		AH91.00-P-0002-01M
	Information on preventing damage to electronic components due to electrostatic discharge		AH54.00-P-0001-01A
	Assessment of airbag and emergency tensioning retractor units in accident vehicles		AH91.00-P-0006-01B
	Legal regulations on handling and storing airbags and emergency tensioning retractor units		AH91.00-P-0004-01A
1	Move front seat far enough forward and up to enable the outer cover (1) to be removed		
2.1	Remove seat cushion (2)	 For removing outer cover (1) from driver seat on vehicles without code (873) Seat heater for left and right front seat, and without code (409) Left/right front multicontour seats.	AR91.10-P-3310CW
2.2	Unfasten seat cushion (2) and place to one side with lines connected	 For removing outer cover (1) from driver seat on vehicles with code (873) Seat heater for left and right front seat, and without code (409) Left/right front multicontour seats. For removing outer cover (1) from front passenger seat.  Make sure there is unobstructed movement of the electrical wiring harnesses under the seat cushion (2), as otherwise there is a risk of damage.  Expose electrical wiring harnesses until the seat cushion (2) can be adequately raised.	AR91.10-P-3310CW
3	Disconnect battery ground line	On vehicles with code (291) PELVIS AIRBAG (PELVISBAG) Model 204 Model 207	AR54.10-P-0003CW AR54.10-P-0003EW
4	Remove screw (arrow B) and unclip hand wheel (3) on outer cover (1) using two assembly wedges	On vehicles without code (275) Memory package (driver seat, steering column, mirrors) or without code (242) Electrically adjustable front passenger seat with memory  Assembly wedge	*110589035900
5	Remove screw (6) on upper inner cover (5)		
6	Unclip outer cover (1) at catch hooks (arrows A) of lower inner cover (4)	 Assembly wedge	*110589035900
7	Remove screws/bolts (9) of pelvis bag at backrest frame	On vehicles with code (291) PELVIS AIRBAG (PELVISBAG) 	*BA91.60-P-1014-01M
8	Remove front screw (7) from seat frame (8)		
9	Pull the outer cover (1) and upper inner cover (5) at the rear on the seat frame (8) far enough apart until the outer cover (1) can be removed with the upper inner cover (5) from the seat frame (8)		
10.1	Remove outer cover (1) far enough from seat frame (8) until the electrical connectors of the driver seat partially electric seat adjustment switch (S22/1) or the front passenger seat partially electric seat adjustment switch (S23/1) can be disconnected	On vehicles without code (275) Memory package (driver seat, steering column, mirrors) or without code (242) Electrically adjustable front passenger seat with memory  Installation: Ensure that the clips (arrows C) of the outer cover (1) on the seat frame (8) are correctly seated.	
10.2	Remove outer cover (1) far enough from seat frame (8) until the electrical connector of the driver seat lumbar support adjustment switch or the front passenger seat lumbar support adjustment switch can be disconnected	On vehicles with code (275) Memory package (driver seat, steering column, mirrors) without code (409) Left/right front multicontour seats or with code (242) Electrically adjustable front passenger seat with memory without code (409) Left/right front multicontour seats	

		i Installation: Ensure that the clips (arrows C) of the outer cover (1) on the seat frame (8) are correctly seated.	
11.1	Disconnect electrical connector of driver seat partially electric seat adjustment switch (S22/1) or front passenger seat partially electric seat adjustment switch (S23/1)	On vehicles without code (275) Memory package (driver seat, steering column, mirrors) or code (242) Electrically adjustable front passenger seat with memory	
11.2	Disconnect electrical connector of driver seat lumbar support adjustment switch or front passenger seat lumbar support adjustment switch	On vehicles with code (275) Memory package (driver seat, steering column, mirrors) without code (409) Left/right front multicontour seats or with code (242) Electrically adjustable front passenger seat with memory without code (409) Left/right front multicontour seats	
12.1	Unclip driver seat partially electric seat adjustment switch (S22/1) or front passenger seat partially electric seat adjustment switch (S23/1) from outer paneling (1) at catch hooks (arrows D)	i Only when replacing outer paneling (1), in vehicles without code (275) Memory package (driver seat, steering column, mirror) or code (242) Electrically adjustable front passenger seat with memory function.	
12.2	Unclip driver seat lumbar support adjustment switch or front passenger seat lumbar support adjustment switch from the outer cover (1)	i Only when replacing outer panel (1), in vehicles with code (275) Memory package (driver seat, steering column, mirrors) without code (409) Left/right front multicontour seats or with code (242) Electrically adjustable front passenger seat with memory function without code (409) Left/right front multicontour seats.	
13	Disconnect driver pelvis airbag electrical connector (X173/1) or front passenger pelvis airbag electrical connector (X173/2)	On vehicles with code (291) PELVIS AIRBAG (PELVISBAG)	
14	Remove outer cover (1)		
15	Remove outer cover (1) from inner upper cover (5)	i Only when replacing outer panel (1).	
16	Remove pelvis bag	i Only when replacing outer panel (1) on vehicles with code (291) PELVIS AIRBAG (PELVISBAG).	AR91.60-P-0300ES
17	Install in the reverse order		

Nm Airbag

Number	Designation		Model 204.3	Model 207
BA91.60-P-1014-01M	Bolt, pelvis airbag to backrest frame	Nm	7.5	7.5

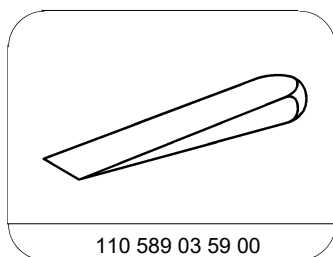

110 589 03 59 00

Mounting wedge