

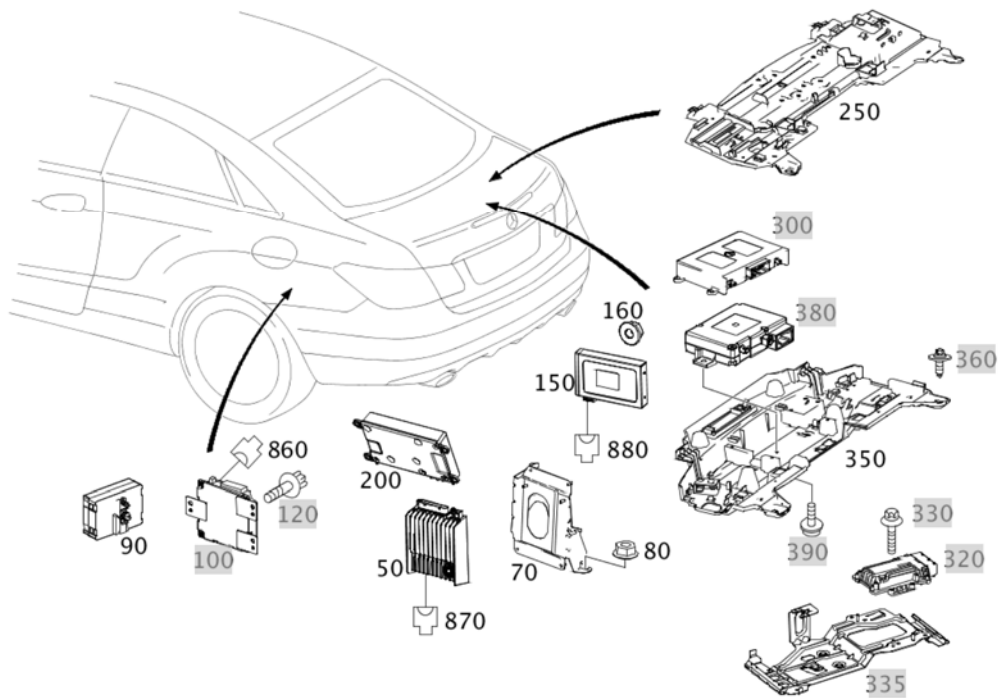













## - Parts list -

<b>Mode</b>	BM mode	<b>Catalog</b>	D48
<b>VIN/mod. des.</b>	WDD2073591F211394	<b>Group</b>	54 ELECTRICAL EQUIPMENT AND INSTRUMENTS
<b>VIN</b>	WDDKJ5KB1DF211394		
<b>Assortment class</b>	PC	<b>Sub-group</b>	077 CONTROL MODULES AND RELAYS IN LOAD COMPARTMENT
<b>Market</b>			
<b>BM overview</b>	E 350 BLUE EFFICIENCY		



Copyright 2020-07-14 Daimler AG

Image ID: drawing\_B54077000185

Item	Part number	Designation/additional information	Qty
50	A 212 900 52 13	<b>CONTROL UNIT, COMPLETE</b> SOUND AMPLIFIER Replaced by: A 212 900 62 26  Code: 810+(803/804/805);  [672] PART MUST BE CHECKED FOR CURRENT FLASHWARE AFTER INSTALLATION  Plant information  Fault location 82557	1
50	A 212 900 62 26	<b>CONTROL UNIT, COMPLETE</b> SOUND AMPLIFIER Replaced by: A 212 900 86 29 Replaces: A2129005213  Code: 810+(803/804/805);  [672] PART MUST BE CHECKED FOR CURRENT FLASHWARE AFTER INSTALLATION  Plant information  Fault location 82557	1
50	A 212 900 86 29	<b>CONTROL UNIT, COMPLETE</b> SOUND AMPLIFIER Replaces: A2129006226 Replaces: A2129005213  Code: 810+(803/804/805);  [672, 697] PART MUST BE CHECKED FOR CURRENT FLASHWARE AFTER INSTALLATION  Fault location 82557  Alternative parts are available	1
50	N 910112 006001	<b>HEXAGON NUT</b> FASTENING AMPLIFIER; M6  Code: 810;	4