





Modification notes

2.3.10	This document has been replaced by a document with an increased number of illustrations		
--------	---	--	--

			AH54.00-P-0001-01A
			OV00.01-P-1901-07A
<p>1</p> 	<p>Buffer basic data for left front door control unit (N69/1) or right front door control unit (N69/2) in STAR DIAGNOSIS</p> <p>Connect STAR DIAGNOSIS and read out fault memory</p>	<p>When replacing left front door control unit (N69/1) or right front door control unit (N69/2).</p> <p>i Installation: Transfer buffered basic data to new left front door control unit (N69/1) or right front door control unit (N69/2).</p>	AD00.00-P-2000-04A



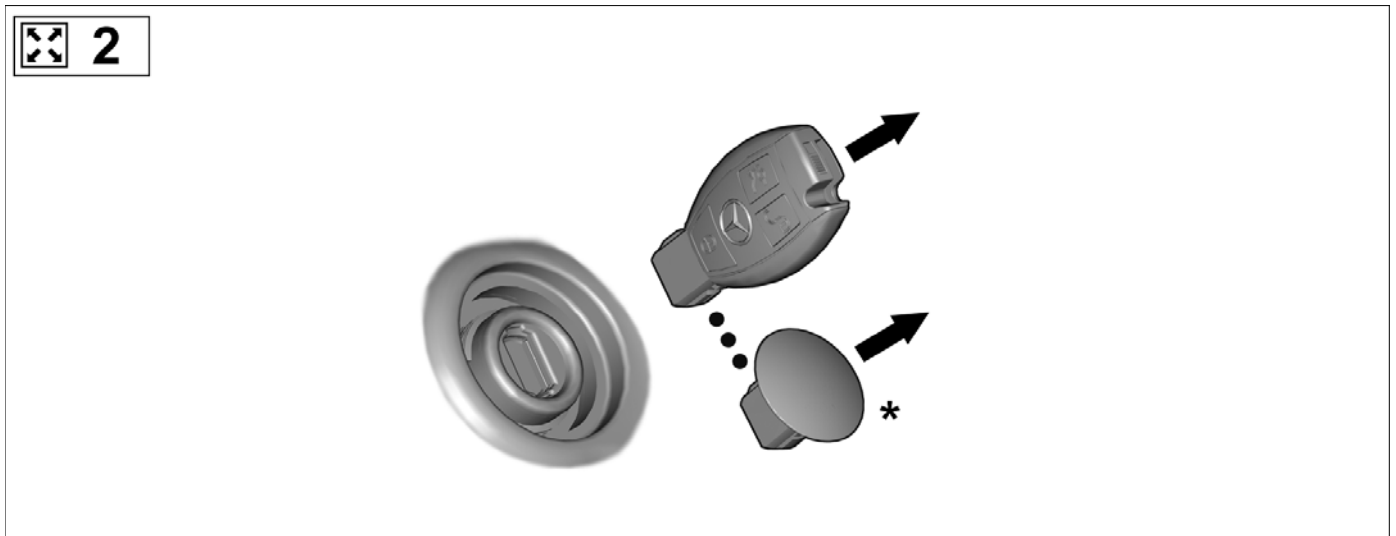

204.0

P83.40-4401-07

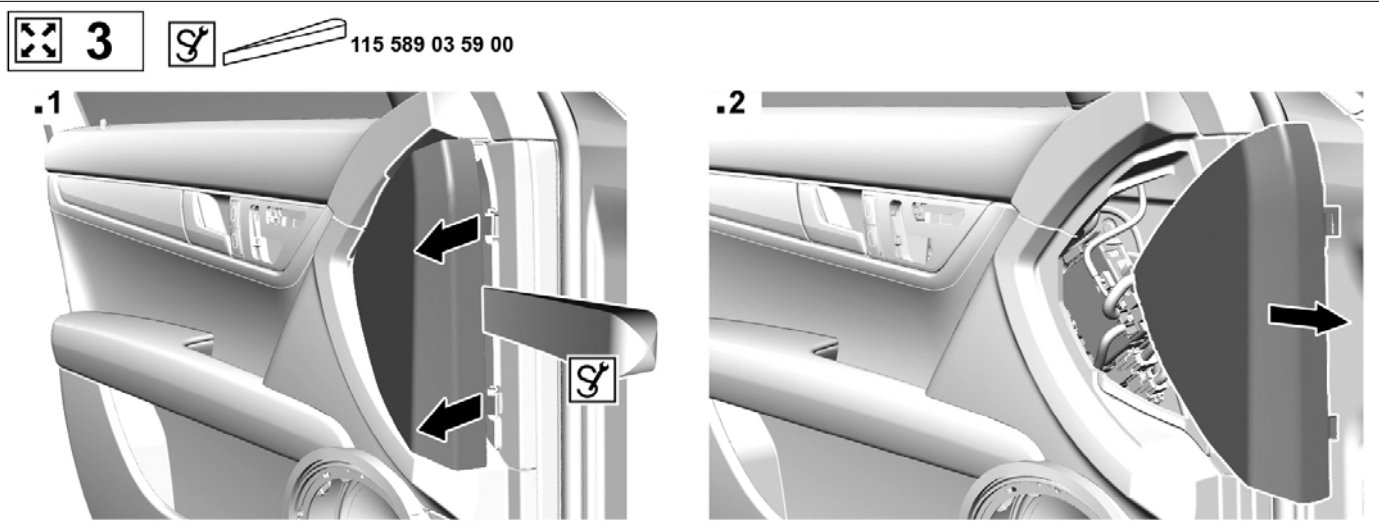

P72.29-2700-08



P72.29-2701-08

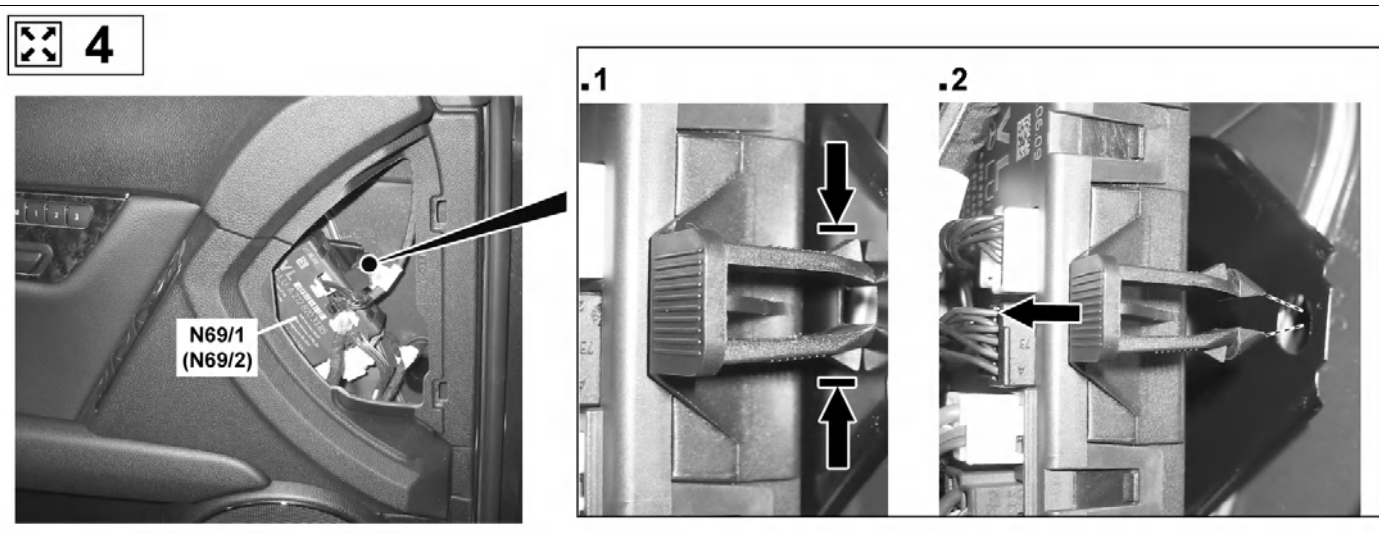

P72.29-2702-08

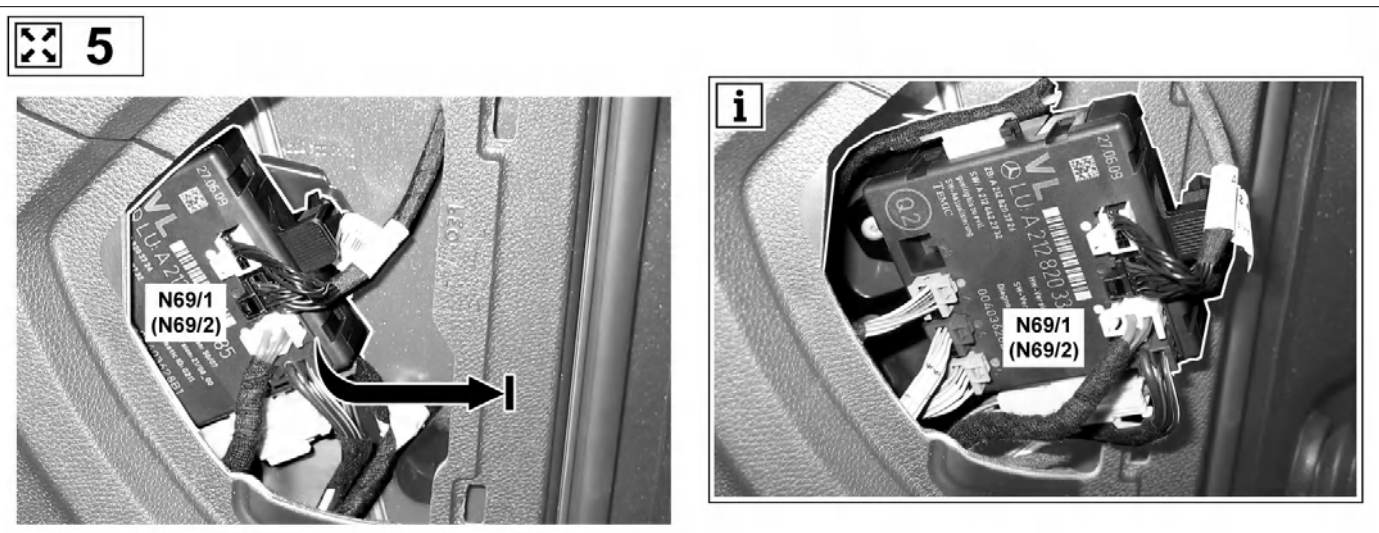

P72.29-2703-08

6

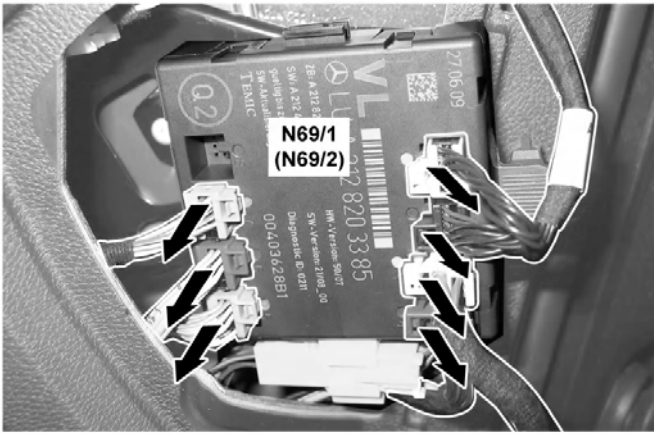

i

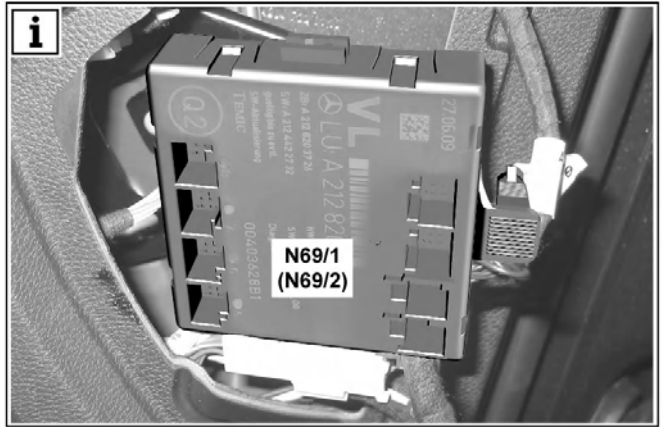

P72.29-2704-08

7

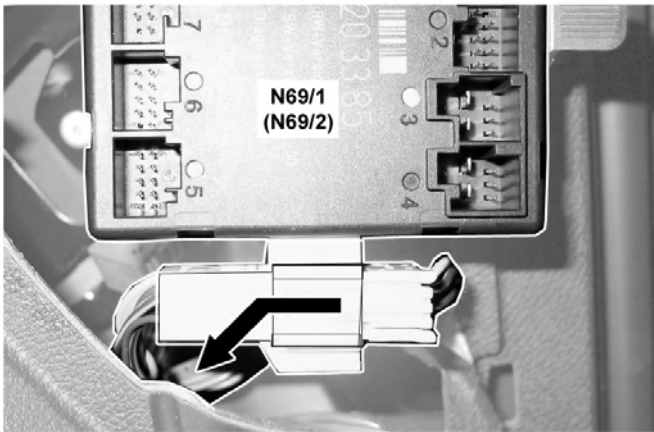

i

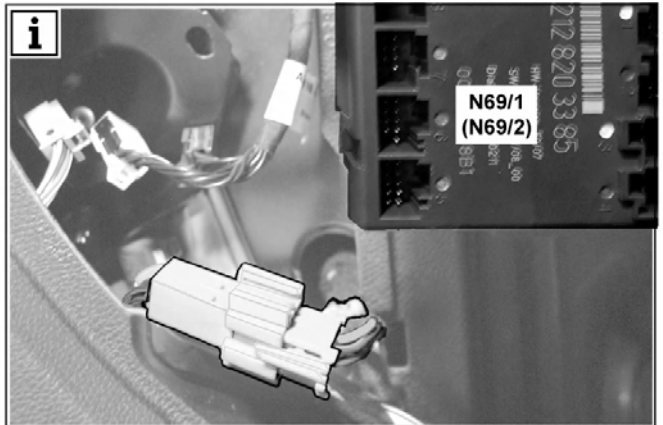

P72.29-2705-08

8

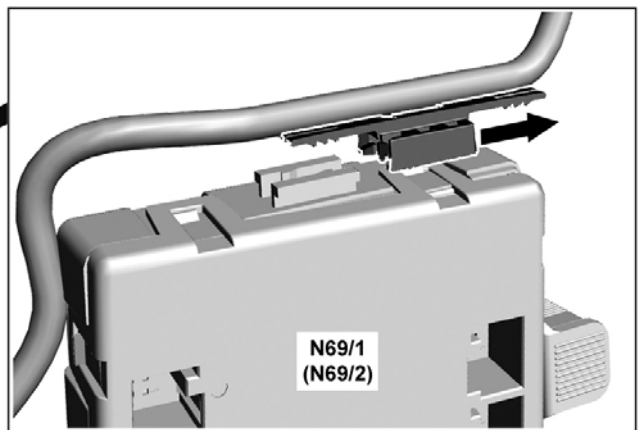
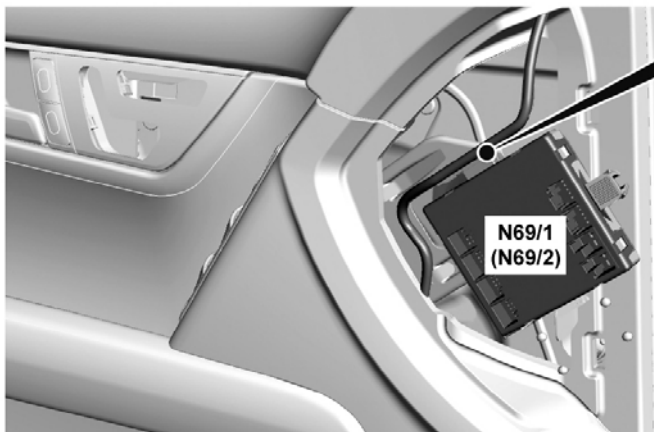

P72.29-2706-08

8 to 1