

## MODEL 204, 207

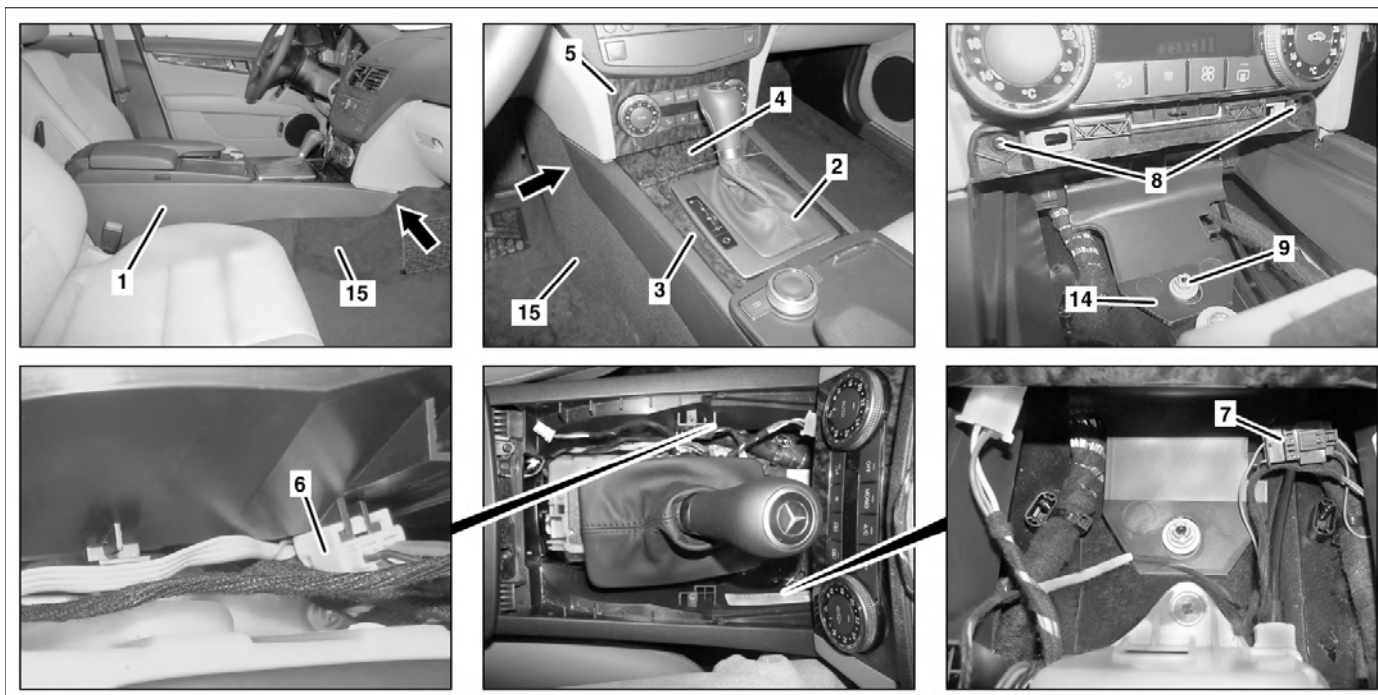

P68.20-3697-09

## Shown on MODEL 204.0 with CODE 523 (Radio MB Audio 20) and CODE 423 (Automatic 5-speed transmission)

- |   |   |   |  |    |                |
|---|---|---|--|----|----------------|
| 1 | Center console  | 5 | Cover  | 9  | Nut            |
| 2 | Boot (MODEL 204.0/2/3, MODEL 204.9 as of model year 2013 except CODE 427 (Automatic transmission 7G-TRONIC PLUS), MODEL 204.9 up to model year 2013, MODEL 207 as of model year 2014 except CODE 427 (Automatic transmission 7G-TRONIC PLUS), MODEL 207 up to model year 2014)                                | 6 | Electrical connector (MODEL 204, MODEL 207 up to model year 2014)  | 14 | Tab            |
| 3 | Cover (MODEL 204.0/2/3, MODEL 204.9 as of model year 2013 except CODE 427 (Automatic transmission 7G-TRONIC PLUS), MODEL 204.9 up to model year 2013, MODEL 207 as of model year 2014 except CODE 427 (Automatic transmission 7G-TRONIC PLUS) except CODE 494 (USA version), MODEL 207 up to model year 2014) | 7 | Electrical connector (MODEL 204.0/2/3, MODEL 204.9 up to model year 2013, MODEL 207 up to model year 2014) | 15 | Floor covering |
| 4 | Stowage box/tray or ashtray (MODEL 204.0/2/3, MODEL 204.9 up to model year 2013, MODEL 207 as of model year 2014 except CODE 427 (Automatic transmission 7G-TRONIC PLUS) except CODE 494 (USA version), MODEL 207 up to model year 2014)  | 8 | Bolts  |    |                |

**Shown on model 204.9 as of model year 2013**

- 3 Cover
- 5 Cover
- 8 Bolts
- 18 Louver (MODEL 204.9 as of model year 2013 with CODE 427 (Automatic transmission 7G-TRONIC PLUS))
- 19 Housing
- 20 Electrical connectors

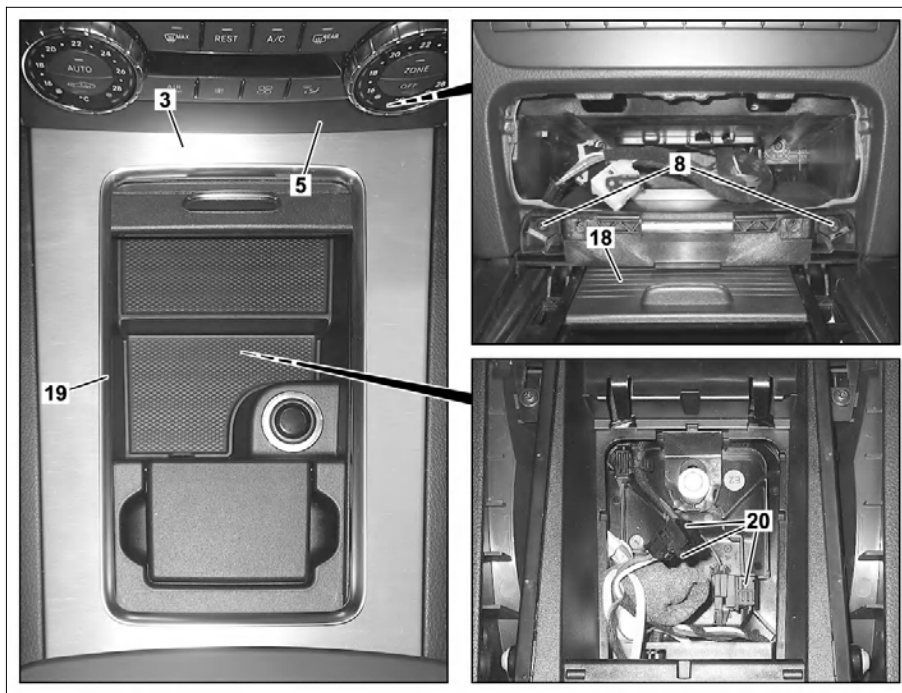

P68.20-4555-06

**Model 204.9 up to model year 2013**

- 16 Cover
- N72/1 Upper control panel control unit

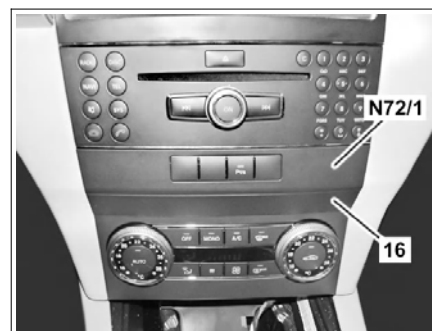

P68.20-4018-01

**Shown on model 204.9 as of model year 2013**

- 1 Center console
- 17 Electrical connector (MODEL 204.9 as of model year 2013, MODEL 207)
- 22 Retaining plate (MODEL 204.9 as of model year 2013 with CODE 386 (Comfort telephony), MODEL 207 as of model year 2012 with CODE 386 (Comfort telephony))
- X18/70 Electrical connector for Media Interface (MODEL 204.9, 207 with CODE 518 (Media Interface))

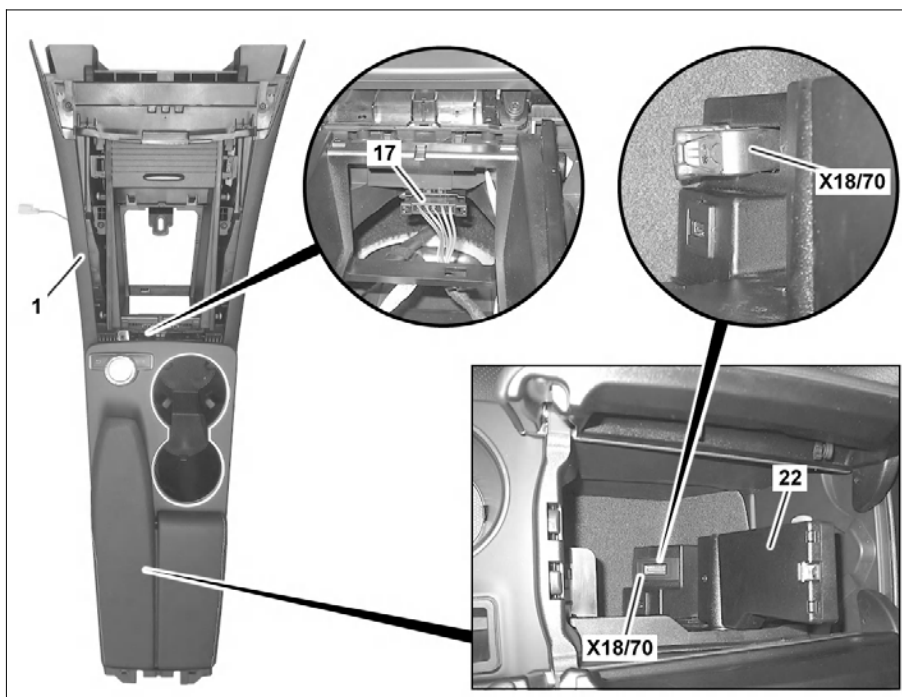

P68.20-4554-06

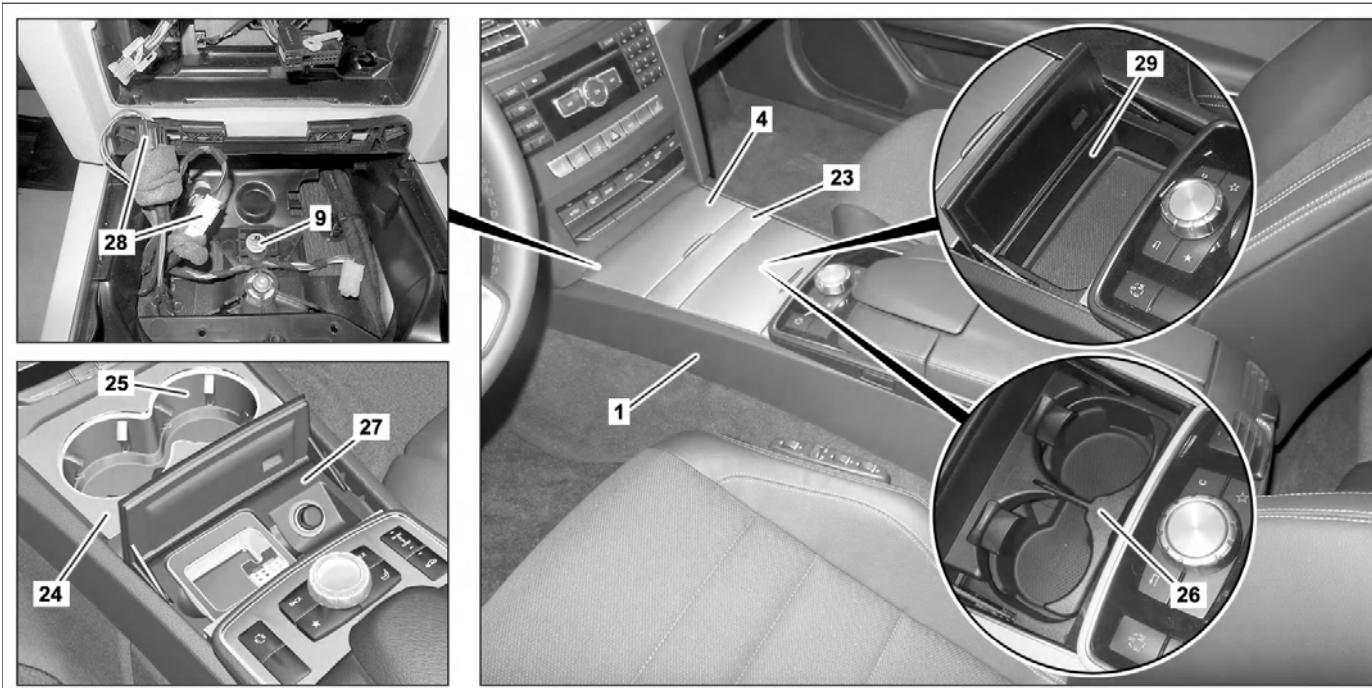

P68.20-4711-09

**Model 207 as of model year 2014**

- |    |   |    |  |    |  |
|----|---|----|--|----|--|
| 1  | Center console  | 24 | Cupholder cover (with CODE 494 (USA version))  | 28 | Electrical connectors  |
| 4  | Stowage box/tray or ashtray (without CODE 494 (USA version))                                  | 25 | Cupholder (with CODE 494 (USA version))  | 29 | Stowage box/tray (with CODE 427 (Automatic transmission 7G-TRONIC PLUS), without CODE 310 (Cupholder), without CODE 494 (USA version)) |
| 9  | Nut   | 26 | Cupholder (with CODE 427 (Automatic transmission 7G-TRONIC PLUS) and CODE 310 (Cupholder), without CODE 494 (USA version)) |    |  |
| 23 | Cover (with CODE 427 (Automatic transmission 7G-TRONIC PLUS), without CODE 494 (USA version)) | 27 | Ashtray (with CODE 494 (USA version))  |    |  |

**Shown on model 207.4**

- |    |   |
|----|---|
| 1  | Center console  |
| 17 | Electrical connector (MODEL 204.9 as of model year 2013, MODEL 207) |



P68.20-4260-11

**Shown on model 204.0**

- 1 Center console
- 10 Cover (without CODE 301 (Ashtray package/smoker package))
- 11 Ashtray (with CODE 301 (Ashtray package/smoker package))
- 12 Nuts
- X39/37 Electrical connector for mobile phone (with code (386) Comfort telephony)

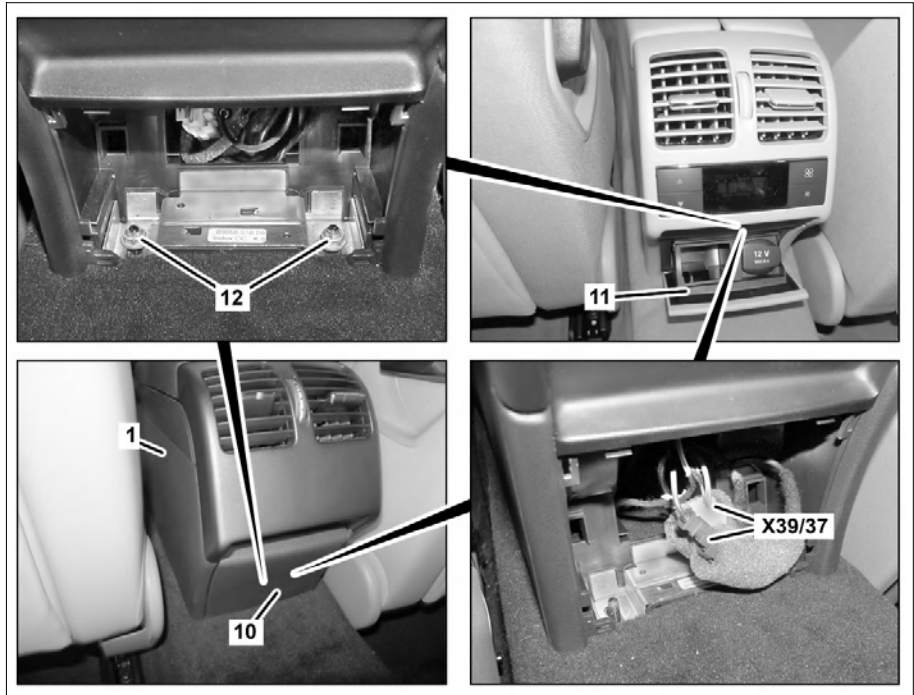

P68.20-3796-06







**Shown on MODEL 207.4 as of 01.06.12 with CODE 386 (Comfort telephony) and with CODE 512 (COMAND APS incl. DVD changer)**

- X39/37 Electrical connector for mobile phone (with code (386) Comfort telephony)
- X115x1 Electrical connector USB (MODEL 204.0/2 as of 01.03.11 with CODE 512 (COMAND APS incl. DVD changer), MODEL 204.3/9 with CODE 512 (COMAND APS incl. DVD changer), MODEL 207 up to 31.05.12 with CODE 088 (control code NTG 4.5) and CODE 510 (Audio 20 CD with CD changer) or CODE 512 (COMAND APS incl. DVD changer) or CODE 523 (Radio MB Audio 20) or CODE 526 (Comand DVD (without Navigation)) or CODE 527 (COMAND APS) or CODE 528 (COMAND incl. DVD changer), MODEL 207 as of 01.06.12)



P82.70-7617-01

	Information on preventing damage to electronic components due to electrostatic discharge		AH54.00-P-0001-01A
	<b>Remove/install</b>		
1	Switch off ignition and remove transmitter key		
2	Unclip boot (2) from cover (3)	MODEL 204.0/2/3 MODEL 204.9 as of model year 2013 without CODE 427 (7-speed automatic transmission) MODEL 204.9 up to model year 2013 MODEL 207 as of model year 2014 without CODE 427 (7-speed automatic transmission) MODEL 207 up to model year 2014 <input checked="" type="checkbox"/> Long wedge	*115589035900
3	Set selector lever in position "N" or gearshift lever to neutral position	MODEL 204.0/2/3 MODEL 204.9 as of model year 2013 without CODE 427 (7-speed automatic transmission) MODEL 204.9 up to model year 2013 MODEL 207 as of model year 2014 without CODE 427 (7-speed automatic transmission) MODEL 207 up to model year 2014 <input type="checkbox"/> Depending on vehicle equipment.	

4	Unclip covering (5)	<p>MODEL 204.0/2 up to model year 2012 MODEL 204.9 as of model year 2013</p> <p> Carefully detach the covering (5) at all four corners using the long wedge. Otherwise the covering (5) can bend or kink in the middle.</p> <p> Long wedge</p>	*115589035900
5.1	Open louver (18)n	<p>MODEL 204.9 as of model year 2013 with CODE 427 (7-speed automatic transmission)</p>	
5.2	Open stowage box/tray (4) or ashtray	<p>MODEL 204.0/2/3 MODEL 204.9 up to model year 2013 MODEL 207 as of model year 2014 without CODE 494 (US version) MODEL 207 up to model year 2014</p> <p> Stowage box/tray or ashtray (4) according to equipment.</p>	
6	Unclip cover (3) upward in front area and remove	<p>MODEL 204.0/2/3 MODEL 204.9 as of model year 2013 without CODE 427 (7-speed automatic transmission) MODEL 204.9 up to model year 2013 MODEL 207 as of model year 2014 without CODE 427 (7-speed automatic transmission) MODEL 207 up to model year 2014</p>	
7	Unclip cover (23) toward front by hand and remove	<p>MODEL 207 as of model year 2014 with CODE 427 (7-speed automatic transmission) without CODE 494 (US version)</p>	
8	Unclip and remove cupholder cover (24)	<p>MODEL 207 with CODE 494 (US version)</p>	
9	Remove cup holder (25)	<p>MODEL 207 with CODE 494 (US version)</p>	
10	Remove cup holder (26)	<p>MODEL 207 as of model year 2014 with CODE 310 (Cup holder) with CODE 427 (7-speed automatic transmission) without CODE 494 (US version)</p>	
11	Remove stowage tray (29)	<p>MODEL 207 with CODE 427 (7-speed automatic transmission) without CODE 310 (Cup holder) without CODE 494 (US version)</p>	
12	Remove ashtray (27)	<p>MODEL 207 with CODE 494 (US version)</p>	
13	Open stowage box/tray (4) or ashtray	<p>MODEL 204.0/2/3 MODEL 204.9 up to model year 2013 MODEL 207 as of model year 2014 without CODE 494 (US version) MODEL 207 up to model year 2014</p> <p> Stowage box/tray or ashtray (4) according to equipment.</p> <p> <b>Installation:</b> Check mechanism for stowage box (4) and ashtray for proper function, if necessary loosen threaded connection from center console (1) and tighten center console (1) without tension.</p>	
14	Remove housing (19) and ashtray or stowage box/tray	<p>MODEL 204.9 as of model year 2013</p> <p> Ashtray or stowage box/tray according to vehicle equipment.</p>	
15	Unclip cover (16) from upper control panel control unit (N72/1)	<p>MODEL 204.9 up to model year 2013</p>	

16	Remove control and operating unit	MODEL 204.0/2/3 as of model year 2012 MODEL 204.9 as of model year 2013 MODEL 207 MODEL 204.0/2/3 as of model year 2012 MODEL 204.9 as of model year 2013 MODEL 207	AR83.40-P-6350CW  AR83.40-P-6350CYA  AR83.25-P-1124EC
17	Disconnect electrical connector (6)	MODEL 204 MODEL 207 up to model year 2014	
18	Disconnect electrical connectors (28)	MODEL 207 as of model year 2014	
19	Disconnect electrical connector (7)	MODEL 204.0/2/3 MODEL 204.9 up to model year 2013 MODEL 207 up to model year 2014	
20	Disconnect electrical connectors (20)	MODEL 204.9 as of model year 2013	
21	Remove screws/bolts (8)	<b>i</b> <b>Installation:</b> Ensure that center console (1) is installed without tension.	
22	Unscrew nut (9)	<b>i</b> <b>Installation:</b> Ensure that center console (1) is installed without tension.	
23.1	Unclip cover (10) from center console (1)	MODEL 204, 207 without CODE 301 (Ashtray package/smoker package)	
23.2	Remove ashtray (11)	MODEL 204, 207 with CODE 301 (Ashtray package/smoker package)	AR68.20-P-2230CW
24	Remove DVD player bracket	MODEL 204.9 with CODE 864 (Rear entertainment system)	AR82.60-P-7506CY
25	Unscrew nuts (12)	<b>i</b> <b>Installation:</b> Ensure that center console (1) is installed without tension.	
26	Disconnect electrical connectors from mobile phone (X39/37)	MODEL 204, 207 with CODE 386 (Comfort telephony)	
27	Disconnect separating point for USB electrical connector (X115x1)	MODEL 204.0/2 as of 3/1/11, 204.3/9 with CODE 512 (COMAND APS with DVD changer) MODEL 207 as of 6/1/12 MODEL 207 up to 5/31/12 with CODE 088 (Control code NTG 4.5) with CODE 510 (Audio 20 CD with CD changer) MODEL 207 up to 5/31/12 with CODE 088 (Control code NTG 4.5) with CODE 512 (COMAND APS with DVD changer) MODEL 207 up to 5/31/12 with CODE 088 (Control code NTG 4.5) with CODE 523 (MB Audio 20 radio) MODEL 207 up to 5/31/12 with CODE 088 (Control code NTG 4.5) with CODE 526 (Comand DVD (without navigation)) MODEL 207 up to 5/31/12 with CODE 088 (Control code NTG 4.5) with CODE 527 (COMAND APS) MODEL 207 up to 5/31/12 with CODE 088 (Control code NTG 4.5) with CODE 528 (COMAND with DVD changer)	
28	Fold retaining plate (22) upward	MODEL 204.9 up to model year 2013 with CODE 386 (Comfort telephony) MODEL 207 as of model year 2012 up to model year 2014 with CODE 386 (Comfort telephony)	
29	Unclip Media Interface electrical connector (X18/70) and feed through downwards	MODEL 204.9, 207 with CODE 518 (Media interface) <b>i</b> <b>Removal:</b> Media Interface electrical connector (X18/70) remains in vehicle. <b>i</b> <b>Installation:</b> Ensure that Media Interface electrical connector (X18/70) is seated correctly.	

30.1	Lift lug (14) and guide center console (1) toward rear out of instrument panel and remove	MODEL 204.0/2/3 MODEL 204.9 up to model year 2013 <b>i</b> <b>Installation:</b> Insert center console (1) into dashboard from top at an angle. Position floor covering (15) on left and right below center console (1) (arrows). Position electrical lines in center console (1) before tightening nuts (9, 12).	
30.2	Lift lug (14) and move center console (1) toward rear until electrical connector (17) is accessible	MODEL 204.9 as of model year 2013 MODEL 207	
31	Disconnect electrical connector (17)	MODEL 204.9 as of model year 2013 MODEL 207	
32	Guide out center console (1) and remove	MODEL 204.9 as of model year 2013 MODEL 207 <b>i</b> <b>Installation:</b> Insert center console (1) into dashboard from top at an angle. Position floor covering (15) on left and right below center console (1) (arrows). Position electrical lines in center console (1) before tightening nuts (9, 12).	
33	Install in the reverse order		

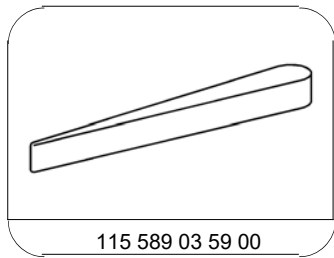

Long wedge