

- Parts list -

<b>Vehicle</b>	WDDKK5GF2BF075590 (69C)	E 350 Cabriolet	
<b>Color</b>	799 - DIAMANTWEISS - METALLICLACK	<b>Equipment</b>	201 - LEDER - SCHWARZ / ANTHRACIT
FIN: WDD2074561F075590		<b>Assortment class</b>	PC
<b>Group</b>	69 COVERING AND LINING	<b>Sub-group</b>	015 ROOF ATTACHMENT PARTS,DOOR EDGE GUARD SECTIONS,PANELLING

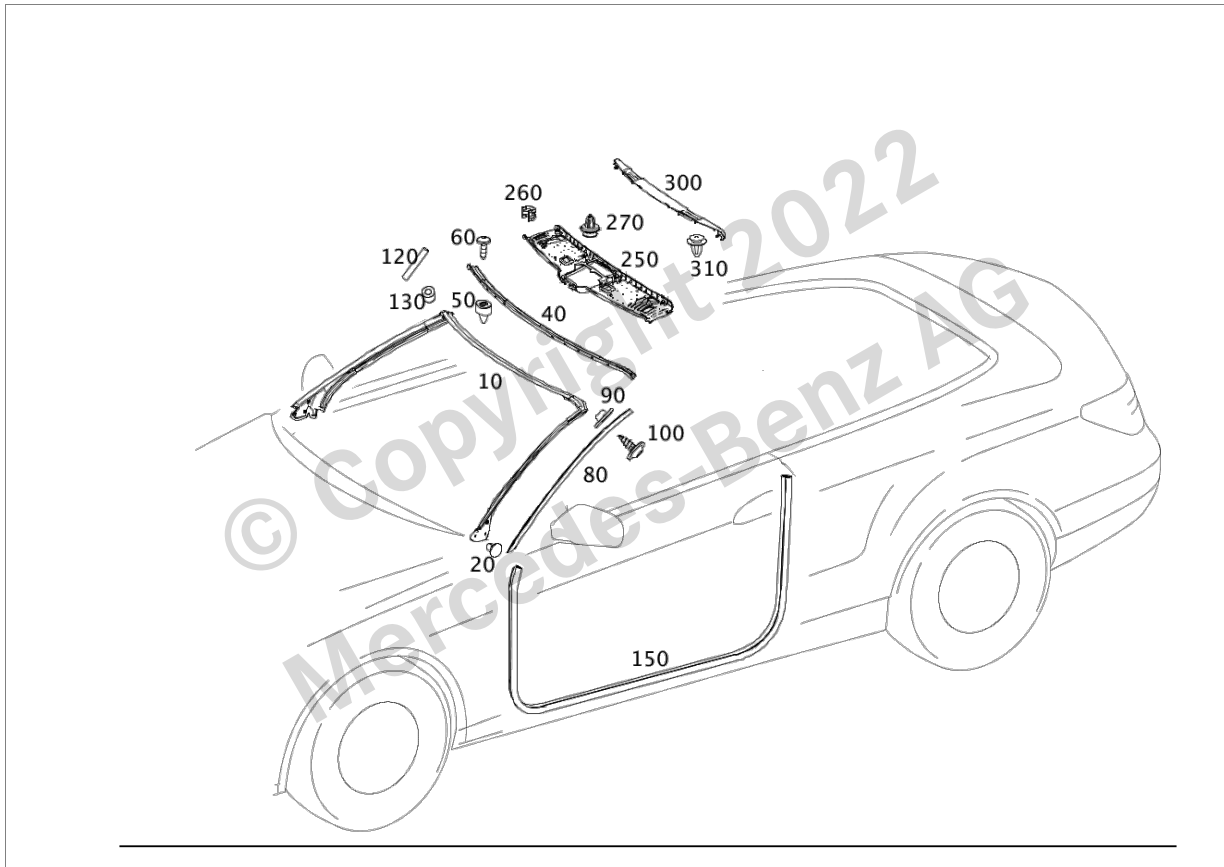













Image ID: drawing\_B69015000300

Item	Part number	Designation/additional information	Qty
10	A 207 671 01 20	SEALING FRAME WINDSHIELD	1
20	A 000 998 10 77	SNAP FASTENER SEALING FRAME AT A-PILLAR, LEFT AND RIGHT	6
40	A 207 720 00 47	RETAINING RAIL WINDSHIELD TOP	1
50	A 123 690 00 18	DOWEL ATTACHMENT,RAIL	6
60	N 000000 000515	TAPPING SCREW ATTACHMENT,RAIL 🗑️ [414] THE OLD PART MUST NO LONGER BE INSTALLED Replaced by: A 006 990 17 12	6
60	A 006 990 17 12	FILLISTER HEAD SCREW ATTACHMENT,RAIL Replaces: N 000000 000515	6

Parts Information

Item	Part number	Designation/additional information	Qty
80	A 207 673 07 83	TRIM STRIP LEFT	1
80	A 207 673 08 83	TRIM STRIP RIGHT	1
90	A 000 991 49 95	PLUG-IN FASTENER TRIM STRIP TO A-PILLAR	12
100	A 006 990 17 12	FILLISTER HEAD SCREW TRIM STRIP FASTENING	12
120	A 004 989 61 20	SEALING TAPE A-PILLAR, LEFT 0.08M  [002882] WHEN ORDERING, STATE ES1 = 10	NB
120	A 004 989 61 20	SEALING TAPE A-PILLAR, RIGHT 0.08M  [002882] WHEN ORDERING, STATE ES1 = 10	NB
130	A 204 429 00 46	ELASTOMER MOLDED PART	2
150	A 207 692 03 76 9B00 	EDGE GUARD FRONT LEFT	1
150	A 207 692 04 76 9B00 	EDGE GUARD FRONT RIGHT	1
250	A 207 690 05 50 7M67  	TRIM, ROOF FRAME BOTTOM	1
260	A 009 988 24 78 	* CLAMP FASTENING FOR LINING	2
270	A 000 994 59 48 	* COVER CLIP FASTENING FOR LINING	4
300	A 207 690 04 50 7E94  	TRIM, ROOF TOP	1
310	A 000 990 85 92 	* COVER CLIP FASTENING FOR LINING	5