

W124 Diagnostic Trouble Codes (DTC) – Models with M104 Engine Only!

The pages in this document have the Diagnostic Trouble Codes (DTC's) for the following models, all of which have M104 inline-6-cylinder engines with HFM-SFI (HFM Sequential Fuel Injection):

- 1993 300E, 300CE, 300TE** (2.8L & 3.2L M104 engines) – sedan, coupe, cabriolet, & wagon
- 1994 E280, E320** (2.8L and 3.2L M104 engines) – sedan, coupe, cabriolet, and wagon
- 1995 E280, E320** (2.8L and 3.2L M104 engines) – sedan, coupe, cabriolet, and wagon

The chassis covered are:

- 124.028** (Sedan with 2.8L, M104.942 engine)
- 124.032** (Sedan with 3.2L, M104.992 engine)
- 124.052** (Coupe with 3.2L, M104.992 engine)
- 124.066** (Cabriolet with 3.2L, M104.992 engine)
- 124.092** (Wagon with 3.2L, M104.992 engine)

The diagnostic connector has 16 pins total, please see the next several pages which explain the details of each pin. Note that there is not a separate pin specifically for the optional ASR (Automatic Slip Regulation traction control). If applicable, the ASR codes will be included in the readouts from pin 14. The DTC's are slightly different on pin 14 between models with ABS only (no ASR), and models with both ABS and ASR. Please make sure you are using the correct sheets when looking up codes for the EA/CC/ISC systems! To determine if your vehicle has ASR, check the instrument cluster. Models with ASR will have an illuminated yellow warning triangle in the top/center of the speedometer.

- Models **without** ASR have a CC/ISC (Cruise Control / Idle Speed Control) module, N4/3, which controls the CC/ISC actuator (M16/2). The ABS control module is N30.
- Models **with** ASR have an EA/CC/ISC (Electronic Accelerator / Cruise Control / Idle Speed Control) module, N4/1, which controls the EA/CC/ISC actuator (M16/1). The ABS/ASR control module is N30/1.

All systems have analog “blink codes” available, which can be read with a home-made LED light box, or with the factory impulse counter tool (which is just a fancy LED light box). However, the digital 3- or 4-digit codes are often more specific than the analog 1- or 2-digit codes, especially for the HFM-SFI system. Reading digital codes requires either a Mercedes digital scanner, such as the HHT (Hand Held Tester) or SDS (Star Diagnosis System); or an aftermarket digital scan tool (such as the Snap-On MT2500, Modis, or Solus). The only systems which have digital communication available are the DM (Diagnostic Module), HFM-SFI (fuel injection, and EA/CC/ISC (electronic accelerator control / ABS / ASR).

The Check Engine Light (CEL) may only be present on models with California emissions. Only these models will have a Diagnostic Module (DM). DM codes can be read using the built-in pushbutton & LED at the 8-pin connector in front of the CAN box, near the 38-pin connector. **ONLY** codes from the DM will show using the built-in LED, you cannot read codes from the HFM-SFI, EA/CC/ISC, SRS, etc from this LED. You can also read the DM blink codes by using a separate LED impulse counter code reader at pin #3, or with a digital scanner.

This document includes the complete list of DTC's for the following systems:

Pin #3 - Diagnostic Module (*May only be present on models with California emissions*)
(WIS Group 07.51, subgroup 8.4, section 11, one page)

Pin #6 - Airbag / SRS (Supplemental Restraint System)
(WIS Group 91.60, subgroup 16.1, section 12, one page) - *Only blink codes are available*

Pin #7 - ACC (Automatic Climate Control)
(WIS Group 83.30, subgroup 0503, section B, four pages) - *Only blink codes are available*

Pin #8 - HFM-SFI Fuel Injection & Digital Ignition System
(WIS Group 07.51, subgroup 1.1, section 11, seven pages)

Pin #9 - Roll Bar (Cabriolet only)
(WIS Group 91.59, subgroup 19.1, section 12, one page) - *Only blink codes are available*

Pin #14 - CC/ISC (Cruise Control / Idle Speed Control) – For models without ASR traction control
(WIS Group 30.21, subgroup 7.3, section 11, two pages)

Pin #14 - EA/CC/ISC (Electronic Accelerator / CC / ISC) – For models with ASR traction control
(WIS Group 30.20, subgroup 6.4, section 11, two pages)

CST / RB (Cabriolet Soft Top / Roll Bar) – Not tested at 16-pin connector – see diagram
(WIS Group 77.39, subgroup 11.1, section 12, two pages) - *Only blink codes are available*

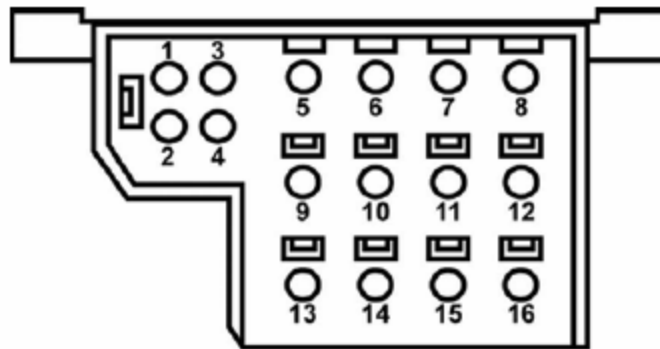

Figure 3-15 16-pin OBD-I connector—fits MB-2 adapter

Table 3-3 16-pin OBD-I connector pinout (sheet 1 of 2)

U.S. MODELS		CALIFORNIA MODELS ONLY (WITH LED)	
PIN	FUNCTION	PIN	FUNCTION
1	Ground	1	Ground
2	Not used	2	Push-button for on-board diagnostics
3	Continuous fuel injection	3	Continuous fuel injection
4	Electronic diesel system		Diagnostic module
5	4MATIC	4	LED
6	Airbag/ETR (SRS)	5	Automatic locking differential
7	Air conditioning (model 124)	6	Airbag/ETR (SRS)
	Roll bar (model 129)		Air conditioning (model 124)
8	Distributor ignition	7	Roll bar (model 129)
	HFM sequential multipoint fuel injection/ignition		Distributor ignition
	Pressurized engine control		HFM sequential multipoint fuel injection/ignition
9	Adaptive damping system	9	Adaptive damping system
	Roll bar (model 124)		Roll bar (model 124)
10	TN-signal (gasoline)	10	Roadster soft top (model 129)
11	Anti-theft alarm		TN-signal (gasoline)
12	Remote central locking	11	Anti-theft alarm
13	Electronic transmission control	12	Remote central locking

Note: Circuit 15 is +12VDC, Ignition Switched

Table 3-3 16-pin OBD-I connector pinout (sheet 2 of 2)

U.S. MODELS		CALIFORNIA MODELS ONLY (WITH LED)	
PIN	FUNCTION	PIN	FUNCTION
14	Electronic accelerator (model 124)	13	Electronic transmission control
	Cruise control/idle speed control (model 124)	14	Electronic accelerator (model 124)
	Engine systems control module (MAS) (model 129)		Cruise control/idle speed control (model 124)
15	Not used		Engine systems control module (MAS) (model 129)
16	Circuit 15	15	Not used
		16	Circuit 15

Diagnosis - Diagnostic Trouble Code (DTC) Memory

Preparation for recalling diagnostic trouble code (DTC) memory

1. Connect impulse counter scan tool and adaptor for impulse counter to test connection for diagnosis (X11/4) according to connection diagram (see section 0).

Note:

Connect impulse counter scan tool as follows:

red wire to socket 16,
black wire to socket 1 and
yellow wire to:

Diagnostic module	socket	3
Engine control module	socket	8
EA/CC/ISC control module	socket	14

2. Recall control modules' diagnostic trouble code memory and clear stored trouble codes (see section 0).

Note

The retained diagnostic trouble code (DTC) memory feature of the diagnostic module has been replaced with DTC memory which is cleared after disconnecting the vehicle's battery (DM voltage supply).

In addition, the DTC readout □1" (no malfunction in system) **does not** appear after clearing the DTC memory (disconnecting the vehicle's battery). DTC readout □1" only reappears during the vehicle's subsequent trip after the diagnostic module has confirmed that all monitored systems and their respective components are ok (no malfunctions).

Special Tools



**DM - Diagnostic Module
(Pin #3)**

Diagnosis - Diagnostic Trouble Code (DTC) Memory

Diagnostic Trouble Code (DTC) Readout, Diagnostic Module

Diagnostic Trouble Code (DTC)	Possible Cause	Remedy/Test Step ¹⁾
1	No malfunction in systems monitored	-
2	Heated oxygen sensor inoperative	Test HFM-SFI, Engines Vol.2, section 1.
3	Lambda control inoperative	Test HFM-SFI, Engines Vol.2, section 1.
4	Air injection inoperative	Test HFM-SFI, Engines Vol.2, section 1.
5	Exhaust gas recirculation inoperative	Test HFM-SFI, Engines Vol.2, section 1.
6	Idle speed control inoperative	Test EA/CC/ISC, sections 6/7.
7	Ignition system defective	Test HFM-SFI, Engines Vol.2, section 1.
8	Engine coolant temperature sensor, open/short circuit	Test HFM-SFI, Engines Vol.2, section 1.
9	Intake air temperature sensor, open/short circuit	Test HFM-SFI, Engines Vol.2, section 1.
10	Voltage at hot wire mass air flow sensor too high/low	Test HFM-SFI, Engines Vol.2, section 1.
11	TN-signal (rpm) at engine control module (N3/4) defective	Test HFM-SFI, Engines Vol.2, section 1.
12	Heated oxygen sensor heater, open/short circuit	Test HFM-SFI, Engines Vol.2, section 1.
15	Wide open throttle information defective	Test EA/CC/ISC, sections 6/7.

¹⁾ Observe Preparation for Test, see □ 22.

Diagnosis - Diagnostic Trouble Code (DTC) Memory

Diagnostic Trouble Code (DTC)	Possible Cause	Remedy/Test Step ¹⁾
16	Closed throttle position information defective	Test EA/CC/ISC, section 6/7.
17	Data exchange malfunction between individual control modules	□ 23 ⇒ 6.0.
18	Adjustable camshaft timing solenoid, open/short circuit	Test HFM-SFI, Engines, Vol. 2, section 1
19	Fuel injectors open/short circuit or self-adaptation in engine control module (N3/4) at limit	Test HFM-SFI and reset engine control module adaptation to mean value, Engines, Vol. 2, section 1
20	Speed signal not present	Test HFM-SFI, Engines, Vol. 2, section 1
21	Purge switchover valve, open/short circuit	Test HFM-SFI, Engines, Vol. 2, section 1
22	Camshaft position sensor signal defective	Test HFM-SFI, Engines, Vol. 2, section 1
23	Intake manifold pressure (in base module pressure sensor- B5/2) with engine running too low/high	□ 23 ⇒ 7.0.
24	Starter ring gear segments and/or crankshaft position sensor defective	Test HFM-SFI, Engines, Vol. 2, section 1
25	Knock sensors or engine control module defective	Test HFM-SFI, Engines, Vol. 2, section 1
26	Upshift delay defective	Test HFM-SFI, Engines, Vol. 2, section 1
27	Not used	-
28	Engine coolant temperature sensor (coolant temperature change monitor)	Test HFM-SFI, Engines, Vol. 2, section 1

¹⁾ Observe Preparation for Test, see □ 22.

Diagnosis - Diagnostic Trouble Code (DTC) Memory (driver-side or driver/passenger-side airbag)

Preliminary work:

Diagnosis - Function Test□ 11

SRS - Airbag
(Pin #6)

Preparation for DTC readout

- Fuses O.K.
- Connect impulse counter scan tool to data link connector (X11/4) according to connection diagram (see section 0).
8 or 16-pole connector: yellow wire to socket 6
38-pole connector: yellow wire to socket 30
- The 10-pole SRS test connection (X11/13) must be connected for DTC.

Special Tools

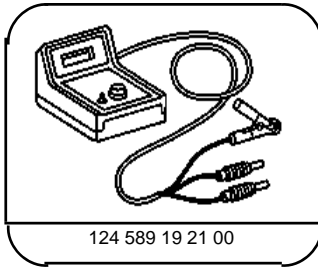

124 589 19 21 00

Pulse counter

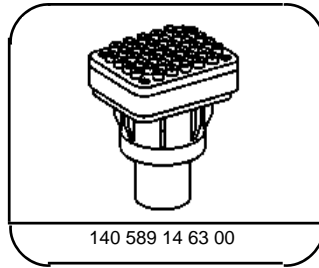

140 589 14 63 00

Adapter

Diagnosis - Diagnostic Trouble Code (DTC) Memory (driver-side or driver/passenger-side airbag)

Diagnostic trouble code (DTC) □	Possible cause	Test step/Remedy ¹⁾
1	No fault recognized in system	-
2	SRS control module (N2/2)	□ 23 ⇒ 2.0
3	Driver airbag squib (R12/3)	□ 23 ⇒ 3.0, 9.0
4	Front passenger airbag squibs (R12/4, R12/5)	□ 23 ⇒ 4.0, 10.0
5	Left front seat belt buckle switch (S68/3)	□ 23 ⇒ 5.0
6	Right front seat belt buckle switch (S68/4)	□ 23 ⇒ 6.0
7	Front passenger airbag resistance	□ 23 ⇒ 7.0
8	Voltage supply circuit 15R	□ 23 ⇒ 1.0
9	SRS malfunction indicator lamp (A1e15) or time limit for DTC readout /erasing exceeded	□ 23 ⇒ 8.0
10 ²⁾	SRS control module (N2/2)	N2/2 (SMS, Job No. 91-620)

¹⁾ Observe Preparation for Test, see □ 22.

²⁾ DTC 10 indicates that the airbag deployment stage was activated in the control module. This DTC can not be erased.

The control module must be replaced.



IMPORTANT NOTE!

Before replacing the SRS control module (N2/2) in cases of DTC 10 without an airbag deployment, reposition airbag harness ground connections to lowest terminal connection.

Note:

The ETR's are not included in the DTC readout, if DTC 3 and/or 4 can not be erased, see ETR Test □ 32 ⇒ 1.0 and 2.0 ¹⁾.

B. All models 124 except models 124.034/036 as of 08/91

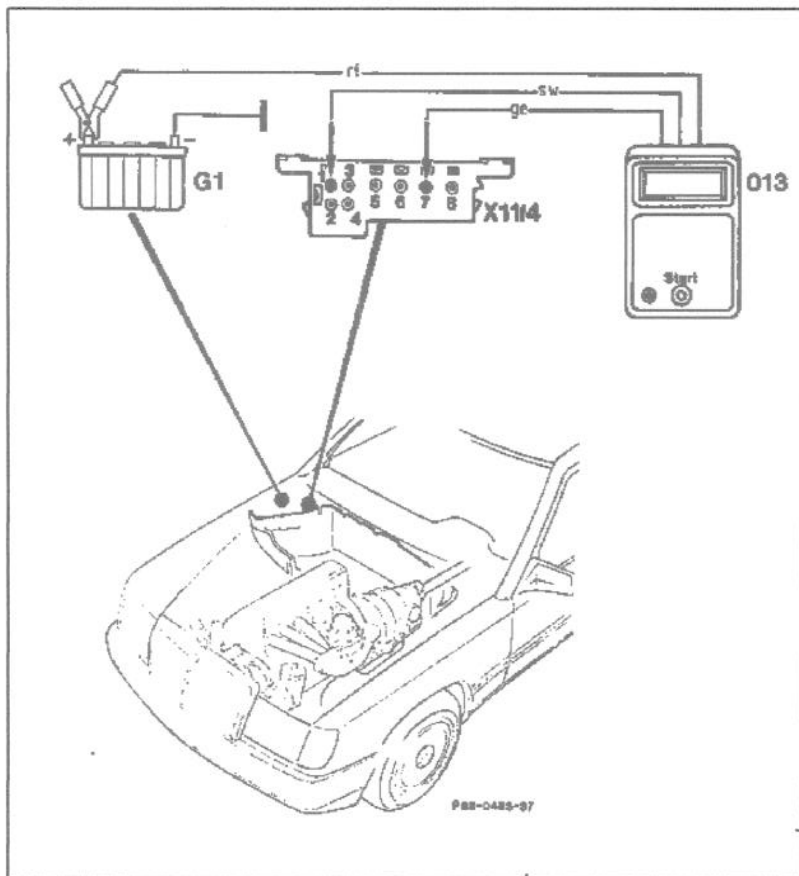

Connection diagram

013 Pulse counter
G1 Battery
X11/4 Test connector for diagnosis, 8-pin (pulse signal)

The quantity of pulses indicates which component or which lines are defective

Pulse readout	Components
1	All functions "in order"
2	In-car temperature sensor, short-circuit
3	In-car temperature sensor, interrupt
4	Outside air temperature sensor, short-circuit

Pulse readout	Components
5	Outside air temperature sensor, interrupt
6	Evaporator temperature sensor, short-circuit
7	Evaporator temperature sensor, interrupt
8	Left heat exchanger temperature sensor, short-circuit
9	Left heat exchanger temperature sensor, interrupt
10	Right heat exchanger temperature sensor, short-circuit
11	Right heat exchanger temperature sensor, interrupt

12	Coolant temperature sensor, short-circuit
13	Coolant temperature sensor, interrupt
30	Circulation pump, short-circuit/interrupt
31/32	Duo valve, short-circuit/interrupt
33	Compressor cut-out control unit, short-circuit/interrupt
34	Auxiliary fan 2nd stage (actuation), short-circuit
56	Valve block (4 connections) (Y11), short-circuit or interrupt
57	Valve block (4 connections) (Y11), short-circuit or interrupt
58	Valve block (4 connections) (Y11), short-circuit or interrupt

ACC
Automatic Climate Control
(Pin #7)

Special tool



Notes on pulse output

The pulse output indicates existing faults, however faults which occur temporarily are not stored.

Testing with the pulse counter is to be performed for more rapid fault finding in the event of faults in the air conditioner/automatic temperature control.

If one or more faults are displayed by the pulse output, then these are to be eliminated and the pulse output to be repeated. This ensures that all faults which are recorded by the pulse output have been eliminated.

If no fault is displayed by the pulse output, but there is a complaint, it is possible that there is a tolerance deviation of components, e.g. too low ohmic value in the case of sensors. Since such a deviation is not recorded by the pulse output, the system is to be completely checked using the socket box and volt-ohmmeter.

ACC
Automatic Climate Control
(Pin #7)

Testing

Connect pulse counter in accordance with the connection diagram.

"UBatt" light emitting diode must light up, if not:
Switch on ignition.

- a) Check fuse
- b) Check socket 1 on test coupling (X11/4) versus battery positive. Nominal value 11-14 V.
- c) Check socket 1 against socket 7 on test coupling (X11/4). Nominal value 6-12 V.

Operate start button for between 2 and 4 seconds.

Read off and note pulse code display.

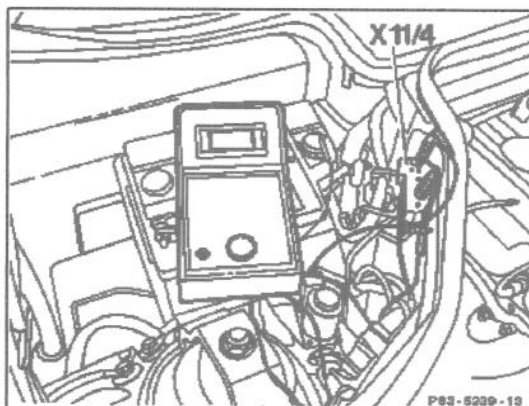

Number 1 means that no fault has been recorded by the pulse output. All further numbers are assigned to a particular fault circuit. If there are several faults in the system, the next fault is automatically output with the subsequent operation of the start button.

ACC
Automatic Climate Control
(Pin #7)

Operate the start button again for between 2 and 4 seconds. If there is no fault in the system, the first number re-appears.

Eliminate noted faults (pulse output) and repeat pulse output, and also switch the ignition on and off.

Note

During the pulse output the light emitting diode in the fresh air/recirculated air switch flashes with 1 Hz.

Diagnosis - Diagnostic Trouble Code (DTC) Memory

Preliminary work:_Engine Test, Adjustment, Engines, Volume 1

Note regarding diagnostic trouble code (DTC) readout:

The engine control module (N3/4) for the HFM-SFI system is equipped with diagnostic trouble code (DTC) memory. Malfunctions are recognized and stored as trouble codes and are distinguished as follows:

- Malfunctions which are constantly present,
- Malfunctions which occur longer than 3 seconds,
- Intermittent contact malfunctions which have occurred 5 × during a trip.

The DTC memory remains active even if the vehicle's battery is disconnected.

Malfunctions which are no longer present, are automatically erased again after a maximum of 19 trips. A trip has occurred if:

- Vehicle speed >4 km/h (2.5 mph),
- Engine speed >700 rpm,
- Engine shut off for 30 seconds.

The stored diagnostic trouble codes (DTCs) can be read at the data link connector (X11/4) with the ignition switched ON or with the engine running.

Diagnosis via an on-off ratio readout has been eliminated.

Diagnosis - Diagnostic Trouble Code (DTC) Memory

Note regarding automatic recognition of vehicle equipment and/or version on vehicles up to 02/94 (up to HHT Diagnosis Version 42):

The engine control module recognizes and stores the following equipment and/or version information during the vehicle's initial operation:

- Catalytic converter/non-catalytic converter,
- Manual/automatic transmission,
- 4-Speed/5-speed automatic transmission,
- Cruise control,
- Electronic accelerator,
-  version.

After replacing the engine control module or after trial installation of an engine control module from another vehicle, the stored data must be erased and the recognition feature reactivated (see Resetting and Reactivating Engine Control Module Memory" 11/5).

Initial programming of engine control module.

Prerequisite for initial programming process:

- Battery voltage ⇒ 11 Volt minimum
 - Vehicle speed signal ⇒ V = 0
 - Engine rpm signal ⇒ n = 0
 - Transmission range ⇒ P/N = 1
 - Idle speed contact closed ⇒ CTP = 1
- (Caution: Vehicle can not be moved during initial programming process)
- Drive vehicle ⇒ V = > 5 km/h (3 mph)
- (Only then will the transmission version be recognized).

Diagnosis - Diagnostic Trouble Code (DTC) Memory

HFM Fuel Injection (Pin #8)

Note regarding mixture preparation self-adaptation:

The Lambda control system determines fuel injection duration precisely so that the fuel/air ratio is kept constant at Lambda level 1 (equals 14.7 kg air to 1 kg fuel) under all operating conditions. Should malfunctions occur in the form of:

- Intake air leaks,
- Injector wear or carbon build-up,
- Engine wear,
- Contact resistance in MAF sensor,
- Defective diaphragm pressure regulator,
- Defective purge control valve,

the engine control module automatically performs a mixture adjustment. The degree of correction is calculated constantly and stored permanently. The self-adaptation is performed at idle and under partial load. Maximum correction towards rich or lean is 25%. After repair work is performed, the engine control module will automatically adapt itself again after approx. 10 trips. After eliminating a malfunction or after trial installation of an engine control module from another vehicle, the self-adaptation feature must be reset to its mean value (see Resetting and Reactivating Engine Control Module Memory" 11/5).

Note regarding version coding on vehicles as of 03/94 (as of HHT Diagnosis Version 45):

The engine control module is equipped with a version coding feature as of 03/94. The coding must be performed with the Hand-Held Tester (automatically or manually, see Notes for HHT 11/4) upon installation of a new control module.

The following vehicle version data must be determined for coding:

- Vehicle model,
- Catalytic converter (TWC),
- Non-catalytic converter (non-TWC),
- 5-speed manual transmission,
- 4-speed automatic transmission,
- 5-speed automatic transmission,
- Cruise control (CC),
- Acceleration slip regulation (ASR),
- Electronic traction system (ETS),
- Country version.

Note regarding drive authorization system (DAS):

- Up to the end of model year 1995, a starter lock-out system is installed which interrupts circuit 50 to the starter.

- On vehicles starting model year 1996 (HHT Diagnosis Version 46), the RCL system is enhanced with a so-called drive authorization system stage 2.

The activation of the drive authorization system (DAS) is initiated by the RCL control module and transmitted to the engine control module via the CAN data bus.

After activation of the drive authorization system (DAS), the fuel injection system is rendered inoperative by the engine control module. The drive authorization system (DAS) can be activated or deactivated with the infrared remote control transmitter or the master key.

The engine control module and RCL control module are permanently locked with one another by an identification code. This identification code can not be erased (see HHT actual values □DAS□ menu selection 3/6).

Therefore, trial installation of an engine control module or RCL control module from another vehicle is no longer possible.

CAUTION!

If a **new** engine control module is installed for test purposes only, a maximum of 40 engine starts can be performed before the control modules are **permanently** locked with one another. **After 40 engine starts, the engine control module can no longer be used in any other vehicle.**

Diagnosis - Diagnostic Trouble Code (DTC) Memory

Notes for HHT

- **Fault search with HHT**

Diagnostic trouble code (DTC) memory: Select □Current DTC's".

If the actual condition changes, e.g. when wiggling a connector, the change is reported optically and acoustically so that troubleshooting can be performed directly with the HHT.

- **Loose connections**

Loose connections are stored if they occur several times in a certain time period. Therefore, they can appear only as □Stored DTC's" and never as □Current DTC's".

- **Nominal values**

All nominal values relative to the actual values shown on the HHT are listed in the Diagnostic Manual, Engines, Volume 1, section A.

- **Actual values for engine coolant temperature, intake air temperature and air mass**

In case of an open or short circuit, the actual value is immediately replaced by a substitute value which is very close to the actual value. Therefore, a fault can not be recognized clearly. A readout of the fault is possible only via the diagnostic trouble code (DTC) memory.

- **Actual value for engine rpm**

In case of the engine rpm's, the HHT display indicates the closed throttle (idle) speed nominal value calculated by the control module on the left and on the right, the rpm actual value. Both values should differ from each other only slightly. The permissible tolerances are not yet determined.

Diagnosis - Diagnostic Trouble Code (DTC) Memory

Additionally, the code number and VIN must be entered (see HHT actual values □DAS", menu selection 3/6).

**HFM Fuel Injection
(Pin #8)**

- **Version coding with HHT as of 03/94 (as of HHT Diagnosis Version 45).**

a) Before replacement of the engine control module, the existing code number must be read and stored with the HHT (menu selection 6 □Version coding"). After installation of the new control module, the previously read code number must be entered.

Note:

If returning a new control module to a PDC, the code number must be erased.

b) If the code number can **not** be read, the vehicle equipment/version must be determined, the corresponding code number obtained from the Spare Parts Microfiche, Group 54 and manually entered with the HHT.

c) When performing a trial installation of a control module with the same part number from another vehicle (to end of model year 1995), but with a different code number, the following must be observed:

- Read and record code number from vehicle with complaint.
- Exchange control modules.
- Read and record code number from the exchanged control module.
- Enter the code number from the original control module into the exchange control module.
- Perform function test.
- Before returning control module to other vehicle, enter recorded code number into exchange control module.
- Exchange control modules.

Notes for HHT (continued)

● **Drive authorization system (DAS)**

Upon replacement the engine control module must be version coded using the HHT. Additionally, the code number and VIN must be entered (see HHT nominal values □DAS", menu selection 3/6).

Preparation for Test with Impulse Counter Scan Tool

Note:

The DTC memory readout, DTC memory clearing as well as resetting and reactivating the engine control module can be performed with the impulse counter scan tool only on vehicles up to HHT Diagnosis Version 46. On vehicles as of HHT Diagnosis Version 49, it is possible only with the HHT.

- Connect impulse counter scan tool to data link connector (X11/4) according to connection diagram.

Reading Diagnostic Trouble Code (DTC) Memory

- Ignition: **ON**
 - Press start button for 2 to 4 seconds.
 - Read and record DTC.
 - Press start button again.
 - Read and record DTC.
- Repeat steps d) and e) until the first DTC reappears.

Clearing Diagnostic Trouble Code (DTC) Memory

- Press start button for 2 to 4 seconds (DTC appears).
- Press start button for 6 to 8 seconds, thereby clearing the previously displayed malfunction (DTC) from memory.
- Repeat steps a) and b) until the number □ 1" appears (no malfunctions stored).

Resetting and Reactivating Engine Control Module Memory

- Clear diagnostic trouble code (DTC) memory.
- After the number □ 1" appears, press start button for 6 to 8 seconds.
- Switch ignition **OFF** and wait a minimum of 2 seconds.
- Turn ignition **ON**, wait a minimum of 10 seconds and then start engine.

Note:

Control modules manufactured by Bosch up to 8/93, the start button must be pressed 5 to 6 seconds to clear the DTC memory and 8 to 9 seconds to reset and reactivate the engine control module memory.

**HFM Fuel Injection
(Pin #8)**

Diagnosis - Diagnostic Trouble Code (DTC) Memory

Special Tools

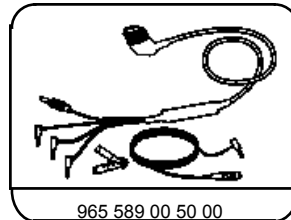
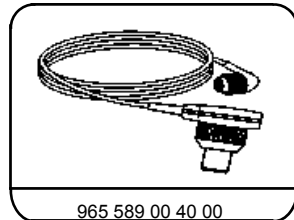
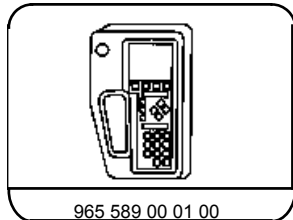
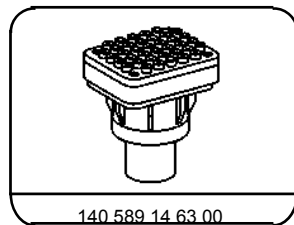
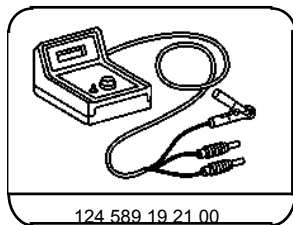

Diagnosis - Diagnostic Trouble Code (DTC) Memory

Connection Diagram - Impulse Counter Scan Tool/ Hand-Held Tester (HHT) Model 124

Impulse counter scan tool

- Black wire circuit 31 (ground) Socket 1
- Red wire circuit 15 (ignition) Socket 16

Hand-Held Tester (HHT)

- Black wire circuit 31 (ground) Socket 1
- White wire circuit 15 (ignition) Socket 16
- Red wire circuit 30 Battery + or X4/10

Connect yellow wire of impulse counter scan tool/ Hand-Held Tester (HHT) as follows:

- Engine control module Socket 8
- EA/CC/ISC control module Socket 14
- Diagnostic module Socket 3

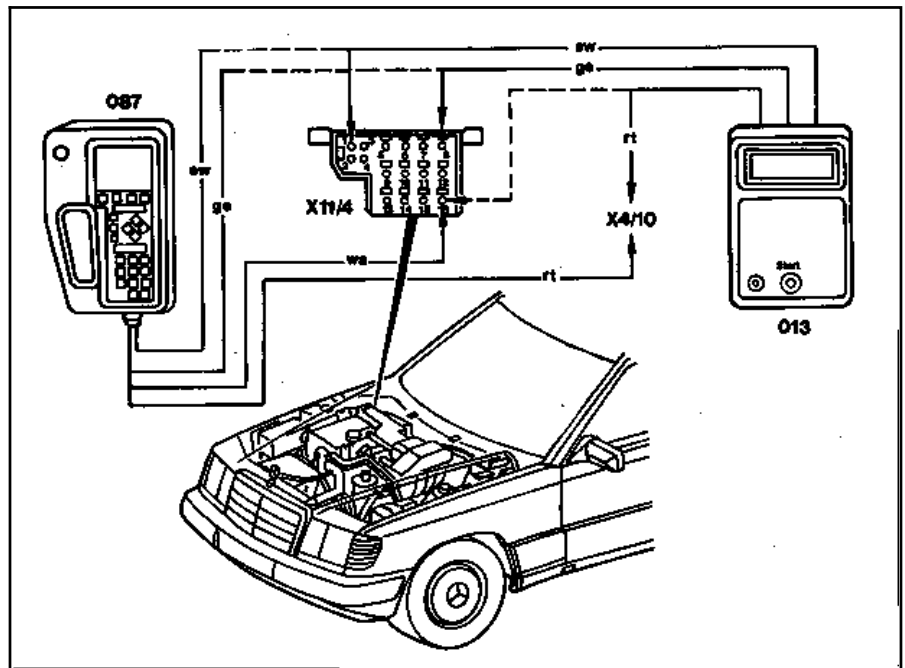

Figure 1

- 013 Impulse counter scan tool (Hand-Held Tester 087 optional)
- 087 Hand-Held Tester (Impulse counter scan tool 013 optional)
- X11/4 Data link connector (DTC readout) (16-pole)

Diagnosis - Diagnostic Trouble Code (DTC) Memory

Connection Diagram - Impulse Counter Scan Tool/
Hand-Held Tester (HHT)

Models 129, 140, 202 and 210

Note:

The DTC memory can be read with the impulse counter scan tool only on vehicles up to HHT diagnosis code 46. On vehicles starting HHT diagnosis code 49 it can be read only with the HHT.

Connect red wire of Impulse counter scan tool to socket 3, black wire of impulse counter scan tool to socket 1, and connect yellow wire as follows:

Engine control module (HFM-SFI)	Socket	4
EA/CC/ISC control module	Socket	7
Base module (except models 202, 210)	Socket	8
Rpm signal (TN output, except models 202, 210)	Socket	13
Rpm signal (TN output, model 202, 210)	Socket	17
Diagnostic module	Socket	19

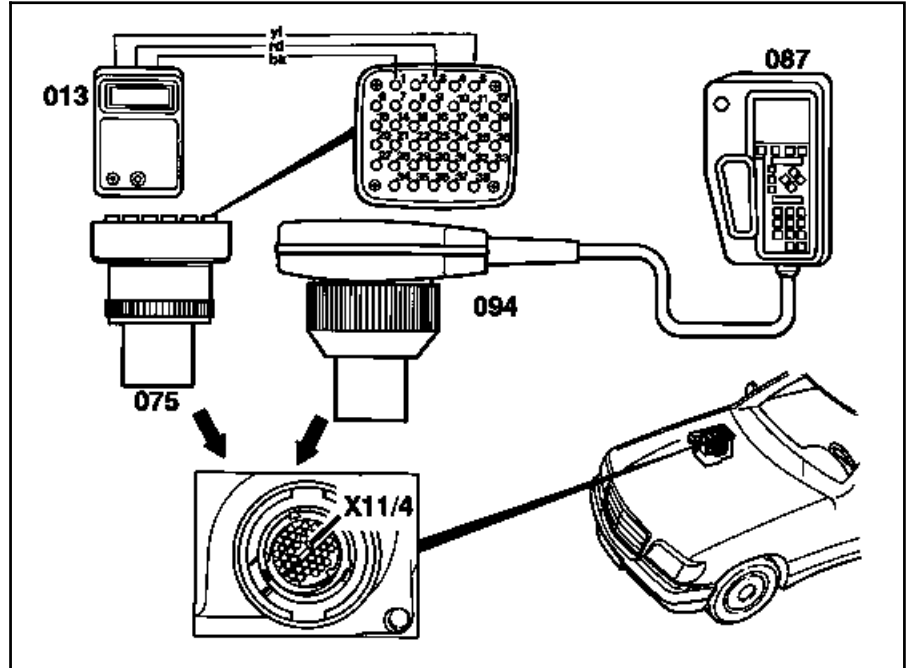

Figure 2

- 013 Impulse counter scan tool (Hand-Held Tester 087 optional)
- 075 Impulse counter scan tool adapter
- 087 Hand-Held Tester (Impulse counter scan tool 013 optional)
- 094 Multiplexer
- X11/4 Data link connector (DTC readout) (38-pole)

U07-5925-57

Diagnosis - Diagnostic Trouble Code (DTC) Memory

DTC (7)	Icon	Possible cause	Test step/Remedy ¹⁾
1	-	No malfunction in system	-
2	002	ECT sensor (B11/3) short circuit	□ 23 ⇒ 8.0
2	003	ECT sensor (B11/3) open circuit	□ 23 ⇒ 8.0
2	004	ECT sensor (B11/3) implausible	□ 23 ⇒ 8.0
2	005	ECT sensor (B11/3) intermittent contact	Contacts in connector of B11/3 or N3/4.
3	006	IAT sensor (B17) short circuit	□ 23 ⇒ 9.0
3	007	IAT sensor (B17) open circuit	□ 23 ⇒ 9.0
3	008	IAT sensor (B17) intermittent contact	Contacts in connector of B17 or N3/4.
4	009	Hot film MAF sensor (B2/5) air flow implausibly high	□ 23 ⇒ 4.0 - 5.0 Engine friction excessive.
4	010	Hot film MAF sensor (B2/5) open circuit	□ 23 ⇒ 4.0 - 5.0
5	011	CTP switch (M16/1s2 or M16/2s2) throttle valve angle implausibly large	□ 23 ⇒ 11.0
5	012	CTP switch (M16/1s2 or M16/2s2) air flow implausibly high	□ 23 ⇒ 11.0
5	013	CTP switch (M16/1s2 or M16/2s2) intermittent contact	□ 23 ⇒ 11.0
6	014	Not applicable for U.S.A. version vehicles	-
6	015	Not applicable for U.S.A. version vehicles	-
6	016	Not applicable for U.S.A. version vehicles	-

1) Observe Preparation for Test, see □ 22.

7) Only possible up to end of model year 1995.

Diagnosis - Diagnostic Trouble Code (DTC) Memory



DTC (7)	Icon	Possible cause	Test step/Remedy ¹⁾
1	017	Not applicable for U.S.A. version vehicles	-
7	018	Not applicable for U.S.A. version vehicles	-
7	019	Not applicable for U.S.A. version vehicles	-
8	020	ISC system at lower control stop	Intake air leak, throttle body binding, CC or EA operating in □limp-home" mode.
8	021	ISC system at upper control stop	Intake air leak, throttle body binding, CC or EA operating in □limp-home" mode.
8	022	CC or EA indicates □limp-home" mode	Intake air leak, throttle body binding, adjust throttle linkage, erase DTC's in HFM-SFI control module.
9 ²⁾	023	O2S 1 (before TWC) (G3/2) sensor voltage too high	□ 23 ⇒ 14.0
9 ²⁾	024	O2S 1 (before TWC) (G3/2) cold or open circuit	□ 23 ⇒ 14.0
9 ²⁾	025	O2S 1 (before TWC) (G3/2) sensor voltage implausible	□ 23 ⇒ 14.0
10	026	Except model 124 O2S 2 (after TWC) (G3/1) sensor voltage too high	□ 23 ⇒ 16.0

10	027	Except model 124 O2S 2 (after TWC) (G3/1) cold or open circuit	□ 23 ⇒ 16.0
10	028	Except model 124 O2S 2 (after TWC) (G3/1) sensor voltage implausible	□ 23 ⇒ 16.0

- 1) Observe Preparation for Test, see □ 22.
 2) The DTC □ 9" can be displayed up to 12/92 even if no fault exists.
 7) Only possible up to end of model year 1995.



**HFM Fuel Injection
(Pin #8)**

Diagnosis - Diagnostic Trouble Code (DTC) Memory

DTC  7)		Possible cause	Test step/Remedy ¹⁾
11	029	O2S 1 (before TWC) heater (G3/2) current too low	□ 23 ⇒ 15.0
11	030	O2S 1 (before TWC) heater (G3/2) current too high	□ 23 ⇒ 15.0
11	031	O2S 1 (before TWC) heater (G3/2) short circuit	□ 23 ⇒ 15.0
12	032	Except model 124 O2S 2 (after TWC) heater (G3/1) current too low	□ 23 ⇒ 17.0
12	033	Except model 124 O2S 2 (after TWC) heater (G3/1) current too high	□ 23 ⇒ 17.0
12	034	Except model 124 O2S 2 (after TWC) heater (G3/1) short circuit	□ 23 ⇒ 17.0
13	035	O2S system operating at rich limit, mixture too lean	Intake air leak, fuel injectors, diaphragm pressure regulator.
13	036	O2S system operating at lean limit, mixture too rich	Intake air leak, fuel injectors, diaphragm pressure regulator.
14	037	Injector (Y62y1), cylinder 1 short circuit to plus	□ 23 ⇒ 19.0
14	038	Injector (Y62y1), cylinder 1 open/short circuit to ground	□ 23 ⇒ 19.0
15	039	Injector (Y62y2), cylinder 2 short circuit to plus	□ 23 ⇒ 20.0
15	040	Injector (Y62y2), cylinder 2 open/short circuit to ground	□ 23 ⇒ 20.0



- 1) Observe Preparation for Test, see □ 22.
 7) Only possible up to end of model year 1995.

Diagnosis - Diagnostic Trouble Code (DTC) Memory

DTC  7)		Possible cause	Test step/Remedy ¹⁾
16	041	Injector (Y62y3), cylinder 3 short circuit to plus	□ 23 ⇒ 21.0
16	042	Injector (Y62y3), cylinder 3 open/short circuit to ground	□ 23 ⇒ 21.0
17	043	Injector (Y62y4), cylinder 4 short circuit to plus	□ 23 ⇒ 22.0
17	044	Injector (Y62y4), cylinder 4 open/short circuit to ground	□ 23 ⇒ 22.0
18	045	Injector (Y62y5), cylinder 5 short circuit to plus	□ 23 ⇒ 23.0
18	046	Injector (Y62y5), cylinder 5 open/short circuit to ground	□ 23 ⇒ 23.0
19	047	Injector (Y62y6), cylinder 6 short circuit to plus	□ 23 ⇒ 24.0
19	048	Injector (Y62y6), cylinder 6 open/short circuit to ground	□ 23 ⇒ 24.0
20	049	Self-adaptation at idle speed too rich	Intake air leak, fuel injectors, diaphragm pressure regulator, engine wear (reset self-adaptation following repair, see □ 11/5).
20	050	Self-adaptation at idle speed too lean	Intake air leak, fuel injectors, diaphragm pressure regulator, engine wear (reset self-adaptation following repair, see □ 11/5).

- 1) Observe Preparation for Test, see □ 22.
 7) Only possible up to end of model year 1995.

Diagnosis - Diagnostic Trouble Code (DTC) Memory

DTC  7)		Possible cause	Test step/Remedy ¹⁾
20	051	Self-adaptation at lower partial load too rich	Intake air leak, fuel injectors, diaphragm pressure regulator, engine wear (reset self-adaptation following repair, see □ 11/5).
20	052	Self-adaptation at lower partial load too lean	Intake air leak, fuel injectors, diaphragm pressure regulator, engine wear (reset self-adaptation following repair, see □ 11/5).
20	053	Self-adaptation at upper partial load too rich	Intake air leak, fuel injectors, diaphragm pressure regulator, engine wear (reset self-adaptation following repair, see □ 11/5).
20	054	Self-adaptation at upper partial load too lean	Intake air leak, fuel injectors, diaphragm pressure regulator, engine wear (reset self-adaptation following repair, see □ 11/5).
21	061	Ignition output 3 or ignition coil (T1/3) for cylinder 1 misfires	□ 24 ⇒ 13.0, 16.0 and 19.0
21	062	Ignition output 3 or ignition coil (T1/3) for cylinder 6 misfires	□ 24 ⇒ 13.0, 16.0 and 19.0

21	063	Ignition output 3 or ignition coil (T1/3) current value not obtained	□ 24 ⇒ 13.0, 16.0 and 19.0
22	055	Ignition output 1 or ignition coil (T1/1) for cylinder 2 misfires	□ 24 ⇒ 11.0, 14.0 and 17.0

- 1) Observe Preparation for Test, see □ 22.
7) Only possible up to end of model year 1995.

**HFM Fuel Injection
(Pin #8)**

Diagnosis - Diagnostic Trouble Code (DTC) Memory

DTC  7)	Possible cause	Test step/Remedy ¹⁾	
22	056	Ignition output 1 or ignition coil (T1/1) for cylinder 5 misfires	□ 24 ⇒ 11.0, 14.0 and 17.0
22	057	Ignition output 1 or ignition coil (T1/1) current value not obtained	□ 24 ⇒ 11.0, 14.0 and 17.0
23	058	Ignition output 2 or ignition coil (T1/2) for cylinder 3 misfires	□ 24 ⇒ 12.0, 15.0 and 18.0
23	059	Ignition output 2 or ignition coil (T1/2) for cylinder 4 misfires	□ 24 ⇒ 12.0, 15.0 and 18.0
23	060	Ignition output 2 or ignition coil (T1/2) current value not obtained	□ 24 ⇒ 12.0, 15.0 and 18.0
	061, 062, 063	see □ 11/13	
24	064	CKP sensor (L5) signal not recognized/improbable	□ 24 ⇒ 7.0
24	065	CKP sensor (L5) magnet is missing (segment control) CKP sensor (L5) number of teeth implausible (increment control)	□ 24 ⇒ 7.0
24	066	CKP sensor (L5) rpm implausibly high	□ 24 ⇒ 7.0
25	067	CMP sensor (L5/1) implausible/not recognized (segment control) Camshaft Hall-effect sensor (B6/1) implausible/not recognized (increment control)	□ 24 ⇒ 8.0 □ 24 ⇒ 9.0
26	068	Not applicable for U.S.A. version vehicles	-
26	069	Not applicable for U.S.A. version vehicles	-
27	070	TN-signal output (rpm signal), short circuit to ground	□ 23 ⇒ 10.0
27	071	TN-signal output (rpm signal), short circuit to plus	□ 23 ⇒ 10.0
28	072	VSS not recognized	□ 23 ⇒ 27.0

- 1) Observe Preparation for Test, see □ 22.
7) Only possible up to end of model year 1995.

Diagnosis - Diagnostic Trouble Code (DTC) Memory

DTC  7)	Possible cause	Test step/Remedy ¹⁾	
28	073	VSS implausibly high	□ 23 ⇒ 27.0
29	075	Not applicable for U.S.A. version vehicles	-
30	076	FP relay module (K27) open/short circuit	□ 23 ⇒ 6.0
31	077	Not applicable for U.S.A. version vehicles	-
	078	Not applicable for U.S.A. version vehicles	-
32	079	KS 1 (A16) open circuit	Replace knock sensors (KS).
32	080	KS 2 (A16) open circuit	Replace knock sensors (KS).
33	081	Maximum retard setting on at least one cylinder has been reached	Increased tendency to knock due to poor fuel quality, combustion chamber carbon build-up or mechanical damage.
33	082	Ignition angle deviation between the individual cylinders is > 6° CKA.	Increased tendency to knock due to poor fuel quality, combustion chamber carbon build-up or mechanical damage.
34	083	Knock control evaluation circuit in engine control module (N3/4) defective	N3/4.
	084	Momentary fault in self-adaptation of closed throttle speed/partial load	Momentary malfunction in fuel mixture preparation.
35	085	Model 124, 129 and 140: AIR pump switchover valve (Y32) and/or electromagnetic AIR pump clutch (Y33), model 202: AIR pump switchover valve (Y32) and/or AIR relay module (K17) open/short circuit	□ 23 ⇒ 28.0
36	086	Purge control valve (Y58/1) open/short circuit	□ 23 ⇒ 29.0 - 30.0

- 1) Observe Preparation for Test, see □ 22.
7) Only possible up to end of model year 1995.

Diagnosis - Diagnostic Trouble Code (DTC) Memory

DTC  7)	Possible cause	Test step/Remedy ¹⁾	
36	087	Purge control valve (Y58/1) short circuit to plus	□ 23 ⇒ 29.0 - 30.0
37	088	Upshift delay switchover valve (Y3/3) open/short circuit	□ 23 ⇒ 34.0
38	089	Adjustable camshaft timing solenoid (Y49) short circuit to plus	□ 23 ⇒ 31.0 - 32.0
38	090	Adjustable camshaft timing solenoid (Y49) open/short circuit to ground	□ 23 ⇒ 31.0 - 32.0
39	091	EGR switchover valve (Y27) short circuit to plus	□ 23 ⇒ 38.0 - 40.0
39	092	EGR switchover valve (Y27) open/short circuit to ground	□ 23 ⇒ 38.0 - 40.0
40	093	Transmission overload protection switch (S65) short circuit to ground	□ 24 ⇒ 10.0
40	094	Transmission overload protection switch (S65) closed and 2nd gear recognized	□ 24 ⇒ 10.0
40	095	Transmission overload protection switch (S65) open and 2nd gear recognized	□ 24 ⇒ 10.0
40	096	Transmission overload protection switch (S65) implausible	□ 24 ⇒ 10.0
41	097	CAN communication from engine control module (N3/4) defective	□ 23 ⇒ 37.0
42	098	CAN communication from ASR control module (N30/1) defective	□ 23 ⇒ 36.0
42	099	CAN communication from EA/CC/ISC control module (N4/1) or CC/ISC control module (N4/3) defective	□ 23 ⇒ 36.0

42	100	CAN communication from diagnostic module (OBD II) (N59/1) defective	<input type="checkbox"/> 23 ⇒ 36.0
43	101	Starter signal (circuit 50) not present	<input type="checkbox"/> 23 ⇒ 7.0
44	102	Not applicable for U.S.A. version vehicles	-
44	103	Not applicable for U.S.A. version vehicles	-

- 1) Observe Preparation for Test, see 22.
7) Only possible up to end of model year 1995.

**HFM Fuel Injection
(Pin #8)**

Diagnosis - Diagnostic Trouble Code (DTC) Memory

DTC  7)	Possible cause	Test step/Remedy ¹⁾
45	104	Fuel safety shut-off of electronic accelerator or cruise control active <input type="checkbox"/> 23 ⇒ 12.0 <input type="checkbox"/> 23 ⇒ 13.0
46	105	Resonance intake manifold switchover valve (Y22/6) short circuit to plus <input type="checkbox"/> 23 ⇒ 33.0
46	106	Resonance intake manifold switchover valve (Y22/6) open/short circuit to ground <input type="checkbox"/> 23 ⇒ 33.0
	107 ⁴⁾	Control of ignition coil preloading voltage exceeds limits <input type="checkbox"/> 24 ⇒ 14.1 and 15.1 Engine control module (N3/4).
48	108	O2S 2 (after TWC) heater relay module (K35) short circuit to plus <input type="checkbox"/> 23 ⇒ 18.0
48	109	O2S 2 (after TWC) heater relay module (K35) open/short circuit to ground <input type="checkbox"/> 23 ⇒ 18.0
49	110	Voltage supply circuit 87 U at engine control module (N3/4) implausible <input type="checkbox"/> 23 ⇒ 2.0
49	111	Voltage supply circuit 87 U at engine control module (N3/4) low voltage <input type="checkbox"/> 23 ⇒ 2.0
50	112	Engine control module (N3/4) N3/4.
	113 ⁵⁾	Engine control module (N3/4) not coded Code N3/4.
	114 ⁵⁾	Engine control module identification of N3/4 faulty Code N3/4, if necessary, replace N3/4.
	115 ⁵⁾	Engine control module code bytes of N3/4 faulty Code N3/4, if necessary, replace N3/4.
	116 ⁶⁾	CAN communication from RCL control module (N54) faulty <input type="checkbox"/> 23 ⇒ 36.1
	117 ⁶⁾	Engine starts with RCL system locked Incorrect operation, clear DTC memory.

- 1) Observe Preparation for Test, see 22.
4) Starting 06/93
5) Starting 01/94
6) Starting model year 1996, models 140/210, the DTC 115 can be displayed from 09/95 and up to 11/95, even if no fault exists.
7) Only possible up to end of model year 1995.

Diagnosis - Diagnostic Trouble Code (DTC) Memory

DTC 	Possible cause	Test step/Remedy ¹⁾
	120	Not applicable for U.S.A. version vehicles -
	121	Not applicable for U.S.A. version vehicles -
	122	Not applicable for U.S.A. version vehicles -
	125	Engine control module (N3/4) N3/4
	126	
	127	ISC and CC/ISC actuators interchanged Replace actuator
	128	Engine control module (N3/4) N3/4
	129	
	130	Not applicable for U.S.A. version vehicles -
	131	Engine control module (N3/4) N3/4
	132	
	133	EA/CC/ISC or CC/ISC actuator Perform learning process on engine control module with HHT. If the fault is still present, replace actuator.
	134	Engine control module (N3/4) N3/4
	135	Not applicable for U.S.A. version vehicles -
	136	Not applicable for U.S.A. version vehicles -
	137	Engine control module (N3/4) N3/4

- 1) Observe Preparation for Test, see 22.

Diagnosis - Diagnostic Trouble Code (DTC) Memory

DTC 	Possible cause	Test step/Remedy ¹⁾
	138	EA/CC/ISC or CC/ISC actuator Perform learning process on engine control module with HHT. If the fault is still present, replace actuator.
	139	Not applicable for U.S.A. version vehicles -
	140	Engine control module (N3/4) N3/4
	141	
	142	
	143	Not applicable for U.S.A. version vehicles -
	144	Engine control module (N3/4) N3/4

- 1) Observe Preparation for Test, see 22.

Diagnosis - Diagnostic Trouble Code (DTC) Memory

Cabriolet Roll Bar
(Pin #9)

To Read Diagnostic Trouble Codes

- Connect impulse counter (yellow wire to socket 9) as shown in section 0.

Ignition: **ON**, Roll bar malfunction indicator lamp comes on.

Special Tools

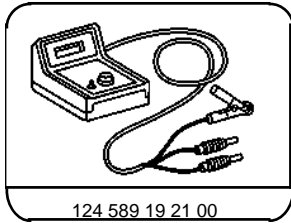

Diagnosis - Diagnostic Trouble Code (DTC) Memory

DTC	Possible cause	Test step/Remedy ¹⁾
I	No diagnostic trouble codes (DTC) stored in memory.	--
2	Roll bar control module (N53)	□ 23 ⇒ 1.0
3	Roll bar control module (N53), voltage supply.	□ 23 ⇒ 2.0
5	Roll bar deployment solenoid (Y57/1), open circuit, short to circuit 30 or 31.	□ 23 ⇒ 3.0
7	Rear axle switch (S83/2 or S83/3) short to circuit 30 or 31.	□ 23 ⇒ 4.0
8	Roll bar malfunction indicator lamp (E30)	□ 23 ⇒ 5.0

¹⁾ Observe Preparation for Test, see □ 22.

Diagnosis - Diagnostic Trouble Code (DTC) Readout

Preparation for DTC Readout

- Connect impulse counter scan tool and/or HHT to data link connector (X11/4) according to connection diagram (see section 0).

Model 124: yellow wire to socket 14

Models 129, 140, 202: yellow wire to socket 7

Model 210: HHT

CC / ISC only
For models without ASR
(Pin #14)

Note concerning Electronic Traction System (ETS) adaptation (only model 202, as of 06/94)

If the CC/ISC control module (N4/3) is replaced, or if a control module from another vehicle is temporarily installed, the ETS adaptation must be activated. Thereby allowing the CC/ISC control module to adapt to the vehicle configuration, ie: with ETS or ABS only.

ETS Adaptation

- Ignition: **ON**
- Wait 3 seconds
- Engine: **Start**
- Wait seven seconds
- Ignition: **OFF** Absolutely required.
- Ignition: **ON**

Diagnosis - Diagnostic Trouble Code (DTC) Readout

Special Tools

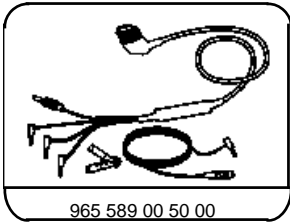
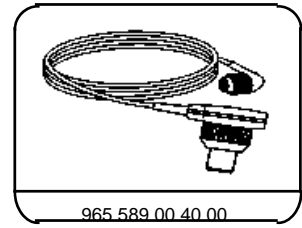
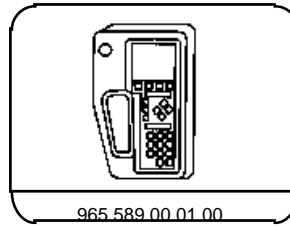
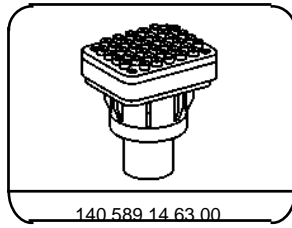
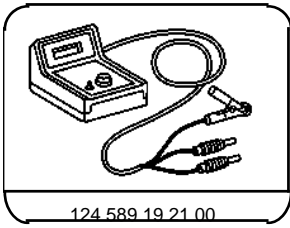

Diagnosis - Diagnostic Trouble Code (DTC) Memory

DTC	Possible cause	Test step/Remedy ¹⁾
-	No fault in system	-
002 006	CC/ISC control module (N4/3) Closed throttle position switch (M16/3s2)	N4/3 <input type="checkbox"/> 23 ⇒ 6.0-8.0 <input type="checkbox"/> 24 ⇒ 16.0
007	Stop lamp switch (S9/1) Cruise control switch (S40) OFF CC/ISC control module (N4/3)	<input type="checkbox"/> 23 ⇒ 2.0 N4/3
008	Actual value potentiometer Starter lock-out/back-up lamp switch (S16/3) (transmission range recognition)	<input type="checkbox"/> 23 ⇒ 4.0, 5.0 <input type="checkbox"/> 23 ⇒ 11.0
009 025	Engine speed (TN) signal Vehicle speed signal (VSS) Safety relay within CC/ISC control module (N4/3) CC/ISC control module (N4/3)	<input type="checkbox"/> 23 ⇒ 13.0 <input type="checkbox"/> 23 ⇒ 15.0 N4/3 N4/3
031	Engine harness Conditions for activation of CC/ISC actuator (M16/2) not fulfilled.	Check harness wire insulation. Conditions: Engine: OFF Transmission range: P/N

¹⁾ Observe Preparation for Test, see 22.

Diagnosis - Diagnostic Trouble Code (DTC) Memory

DTC	Possible cause	Test step/Remedy ¹⁾
034 048 049 050 051 057 055	CC/ISC actuator (M16/2) Throttle valve actual value potentiometer (M16/2r1) Drive actual value potentiometer (M16/2r2) Safety contact switch (M16/2s1) CTP switch recognition (M16/2s2) Potentiometer voltage supply Reset not accomplished (actuator adaptation)	<input type="checkbox"/> 23 ⇒ 3.0-10.0 <input type="checkbox"/> 23 ⇒ 5.0 <input type="checkbox"/> 23 ⇒ 4.0 <input type="checkbox"/> 23 ⇒ 6.0, 8.0 <input type="checkbox"/> 23 ⇒ 7.0 <input type="checkbox"/> 23 ⇒ 3.0 Erase DTC: Ignition: OFF Ignition: ON (for at least 90 seconds) If DTC reappears: CC/ISC actuator (M16/2)
064	CC switch (S40)	<input type="checkbox"/> 23 ⇒ 2.0
080	Stop lamp switch (S9/1)	<input type="checkbox"/> 23 ⇒ 16.0

6	091	Not valid for U.S. vehicles
---	-----	-----------------------------

1) Observe Preparation for Test, see □ 22.

Diagnosis - Diagnostic Trouble Code (DTC) Memory

DTC	Possible cause	Test step/Remedy ¹⁾
 112 115, 117	CAN databus: Message from CC/ISC control module (N4/3) faulty Reception from engine control module (N3/4) faulty	<input type="checkbox"/> 23 ⇒ 19.0 N4/3
128, 129, 130	Left front axle VSS sensor (L6/1) from ABS (N30) or ETS/SPS (N47-2) control module	<input type="checkbox"/> 23 ⇒ 14.0
144	Rear axle VSS sensor (L6) from ABS control module (N30) Left rear axle VSS sensor (L6/3) from ETS/SPS control module (N47-2)	<input type="checkbox"/> 23 ⇒ 15.0
145	Incorrect CC/ISC control module (N4/3) installed	N4/3
146	ETS signal	<input type="checkbox"/> 23 ⇒ 20.0
160	Engine speed signal (TN) from engine control module (N3/4)	<input type="checkbox"/> 23 ⇒ 13.0
176-178, 182	Fuel safety shut-off signal to engine control module (N3/4)	<input type="checkbox"/> 23 ⇒ 17.0

1) Observe Preparation for Test, see □ 22.

CC / ISC only
For models without ASR
 (Pin #14)

Diagnosis - Diagnostic Trouble Code (DTC) Memory

Preparation for DTC Readout

- Connect impulse counter scan tool and/or HHT to data link connector (X11/4) according to connection diagram (see section 0).

Model 124: yellow wire to socket 14

Models 129, 140, 202: yellow wire to socket 7

Model 210: Only possible with HHT.

Note:

The Test Program is divided into two sections:

- Electronic accelerator with ISC
- Cruise control

According to the diagnosis made, troubleshoot by performing only the related test steps in the particular group.

EA / CC / ISC
For models *with* ASR
(Pin #14)

Special Tools

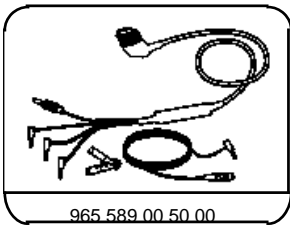
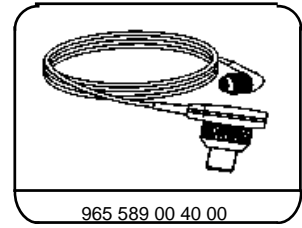
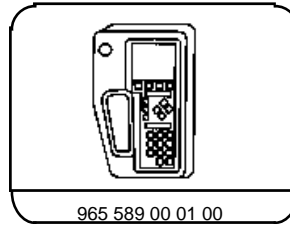
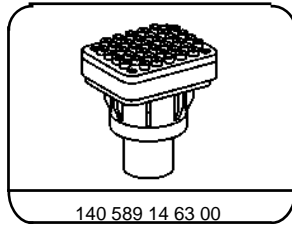
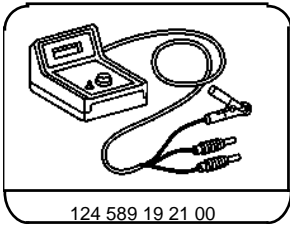

Diagnosis - Diagnostic Trouble Code (DTC) Memory

DTC	Possible cause	Test step/Remedy ¹⁾
1	No fault in system	-
2	EA/CC/ISC control module (N4/1) Safety contact switch (M16/1s1) Stop lamp switch (S9/1) Safety contact switch (M16/1s1) Cruise control switch (S40) OFF EA/CC/ISC control module (N4/1) Actual value potentiometer (M16/1r2) Starter lock-out/back-up lamp switch (S16/3) (transmission range recognition) Closed throttle position switch (S29/3) Engine speed (TNA) signal Vehicle speed signal (VSS) Safety relay within EA/CC/ISC control module (N4/1) EA/CC/ISC control module (N4/1) Engine harness	N4/1 □ 23 ⇒ 5.0, 6.0 □ 23 ⇒ 4.0 □ 23 ⇒ 7.0 □ 24 ⇒ 1.0 N4/1 □ 23 ⇒ 4.0 □ 23 ⇒ 12.0, □ 24 ⇒ 3.0 □ 23 ⇒ 11.0 □ 23 ⇒ 14.0 □ 23 ⇒ 15.0, 16.0 N4/1 N4/1 Check harness wire insulation.
3	Conditions for activation of EA/CC/ISC actuator (M16/1) not fulfilled.	Conditions: Engine: OFF Transmission range: P/N

¹⁾ Observe Preparation for Test, see □ 22.

Diagnosis - Diagnostic Trouble Code (DTC) Memory

DTC	Possible cause	Test step/Remedy ¹⁾
3	EA/CC/ISC actuator (M16/1) Reference potentiometer (M16/1r1) (voltage supply) Reference potentiometer (M16/3r1) Actual value potentiometer (M16/3r2) Safety contact switch (M16/3s1) Closed throttle position switch (M16/1s2) Actuator motor (M16/1m1) Magnetic clutch (M16/1k1) Reset not accomplished (actuator adaptation)	□ 23 ⇒ 2.0- 10.0 □ 23 ⇒ 2.0 □ 23 ⇒ 3.0 □ 23 ⇒ 4.0 □ 23 ⇒ 7.0, 8.0 □ 23 ⇒ 6.0, 8.0 □ 23 ⇒ 9.0 □ 23 ⇒ 10.0 Erase DTC: Ignition: OFF Ignition: ON (for at least 90 seconds). If DTC reappears: EA/CC/ISC actuator (M16/1)
4	CC switch (S40)	□ 24 ⇒ 1.0
5	Stop lamp switch (S9/1)	□ 24 ⇒ 2.0
6	Starter lock-out/backup lamp switch (S16/1) Not applicable to U.S. version vehicles	□ 23 ⇒ 12.0, □ 24 ⇒ 3.0

¹⁾ Observe Preparation for Test, see □ 22.

Diagnosis - Diagnostic Trouble Code (DTC) Memory

DTC	Possible cause	Test step/Remedy ¹⁾
 7 112 115, 117	CAN databus: Message from EA/CC/ISC control module (N4/1) faulty Reception from engine control module (N3/4) faulty	<input type="checkbox"/> 23 ⇒ 20.0 N4/1
8 128-130	Left front axle VSS (L6/1) from ASR control module (N30/1)	<input type="checkbox"/> 23 ⇒ 15.0
9 144	Models 129, 140, 202, 210: Left rear axle VSS (L6/3) from ASR control module (N30/1) Model 124: Hall-effect speed sensor (B6)	<input type="checkbox"/> 23 ⇒ 16.0 <input type="checkbox"/> 23 ⇒ 17.0
10 160	Engine speed signal (TN) from engine control module (N3/4)	<input type="checkbox"/> 23 ⇒ 14.0
11 116-118, 182 180	Fuel safety shut-off signal to engine control module (N3/4) Closed throttle recognition signal to engine control module (N3/4)	<input type="checkbox"/> 23 ⇒ 18.0 <input type="checkbox"/> 23 ⇒ 19.0
14 001 224	CTP switch (S29/3)	<input type="checkbox"/> 23 ⇒ 11.0
15 240	CAN databus: data exchange with ASR control module (N30/1) implausible	ASR control module (N30/1)

1) Observe Preparation for Test, see 22.

EA / CC / ISC
For models with ASR
(Pin #14)

Diagnosis - Diagnostic Trouble Code (DTC) Memory

Preliminary work: Diagnosis - Function Test □ 11
 Read out Diagnostic Trouble Codes, see section 0

Special Tools

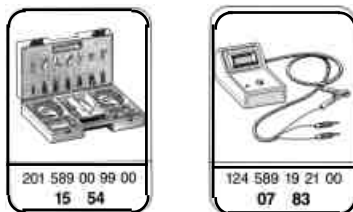

Diagnosis

Limit switch diagnostic trouble codes (DTC's) are only stored when the soft top stops moving during soft top operation and the switch is held depressed until the indicator lamp begins blinking. The exceptions are the switches for roll bar extended and roll bar retracted where the indicator lamp in the roll bar switch lights. DTC's 5 - 16 are considered limit switch DTC's, which do not necessarily mean the respective switch is defective, but rather should be interpreted as an indication of which limit switch signals are absent and are needed for the sequence to continue.

Possible causes:

- Electrical fault (the last soft top or roll bar movement requested was completed).
- Hydraulic fault (the last soft top or roll bar movement requested, did not occur).

CST - Cabriolet Soft Top
RB - Roll Bar
Not tested at 16-pin connector!
Test at X11/12 as shown below.

Diagnosis - Diagnostic Trouble Code (DTC) Memory

Connection Diagram -

Impulse Counter Scan Tool

Connect to socket 2 of X11/12 located in right front passenger footwell.
 To avoid need for extension cable (010), connect black lead of impulse counter scan tool to good ground and red lead to X4/10 inside vehicle interior.

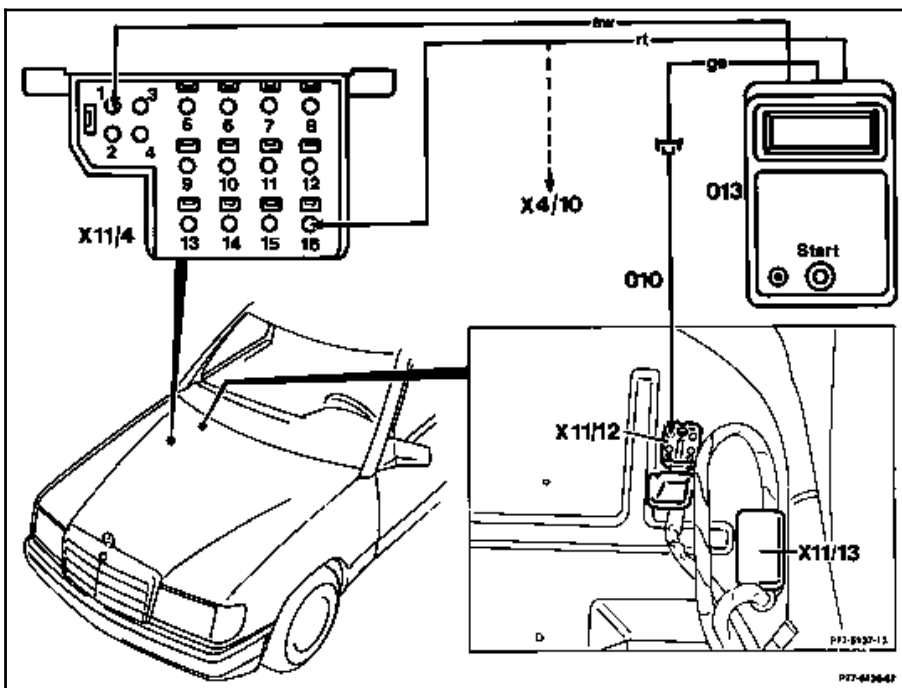

Figure 1

- 010 Extension cable
- 013 Impulse counter scan tool
- X4/10 Terminal block (circuit 30/circuit 61 battery)
- X11/4 Data link connector (DTC readout)
- X11/12 Power soft top test connector (4-pole)
- X11/13 SRS test connector (10-pole)

Diagnosis - Diagnostic Trouble Code (DTC) Memory

Diagnostic trouble code (DTC)	Possible cause	Test step/Remedy ¹⁾
1	No DTC's stored.	-
2	Low voltage	□ 23 ⇒ 1.0
3	Normal operating time exceeded	□ 23 ⇒ 3.0
4	Illogical limit switch signals	□ 24
5	Soft top compartment cover □locked" switch (A25/1s2)	□ 23 ⇒ 5.0
6	Soft top compartment cover □closed" switch (A25/1s1)	□ 23 ⇒ 6.0
7	Soft top storage compartment □open" switch (S84/5)	□ 23 ⇒ 7.0
8	Soft top fabric bow □locked" switch (S84/8)	□ 23 ⇒ 8.0
9	Soft top fabric bow □down" switch (S84/7)	□ 23 ⇒ 9.0
10	Soft top fabric bow □raised" switch (S84/6)	□ 23 ⇒ 10.0
11	Left front soft top □locked" switch (S84/1)	□ 23 ⇒ 11.0
12	Right front soft top □locked" switch (S84/2)	□ 23 ⇒ 12.0
13	Soft top □open" switch (soft top in storage compartment) (S84/3)	□ 23 ⇒ 13.0
14	Soft top □overhead" switch (S84/4)	□ 23 ⇒ 14.0
15	RB □retracted" switch (S83/5)	□ 23 ⇒ 15.0

¹⁾ Observe Preparation for Test, see □ 22.

Diagnosis - Diagnostic Trouble Code (DTC) Memory

Diagnostic trouble code (DTC)	Possible cause	Test step/Remedy ¹⁾
16	RB "extended" switch (S83/6)	□ 23 ⇒ 16.0
17	Automatic deployment of roll bar has occurred	□ 23 ⇒ 17.0
18	Power soft top switch (S84)	□ 23 ⇒ 18.0
19	Vehicle speed signal	□ 23 ⇒ 19.0
20	Circuit in control module (N52), solenoid valve, roll bar retracted	N52
21	Circuit in CST/RB hydraulic unit (A7/5), circuit in RB rod side valve (Y57y10)	□ 23 ⇒ 2.0, 21.0
22	Circuit in control module (N52), solenoid valve, roll bar extended	N52
23	Circuit in RB piston side valve (Y57y11)	□ 23 ⇒ 23.0
24	Circuit in control module (N52), power windows	N52

¹⁾ Observe Preparation for Test, see □ 22.

CST - Cabriolet Soft Top
RB - Roll Bar
Not tested at 16-pin connector!
Test at X11/12 as shown above.