

AR54.30-P-6049EB

Removing and installing bulbs in instrument cluster

16.4.96

MODEL 210**Model 210 without multi-function display**

A1 Instrument cluster

e1 Left turn signal indicator lamp

e2 Right turn signal indicator lamp

e3 High beam indicator lamp

e4 Fuel reserve indicator lamp

e5 Generator charge indicator lamp

e6 Brake pad wear indicator lamp

e7 Low brake fluid level/parking brake indicator lamp

e8 Instrument illumination

e9 Seat belt reminder lamp

e11 Low ECL indicator lamp

e12 Low engine oil level indicator lamp

e13 Low windshield washer fluid level indicator lamp

e14 Exterior lamp failure indicator lamp

e15 SRS malfunction indicator lamp

e16 Preglow indicator lamp

e17 ABS malfunction indicator lamp

e27 ADS malfunction indicator lamp

e34 EDC (Electronic Diesel Control) malfunction indicator lamp

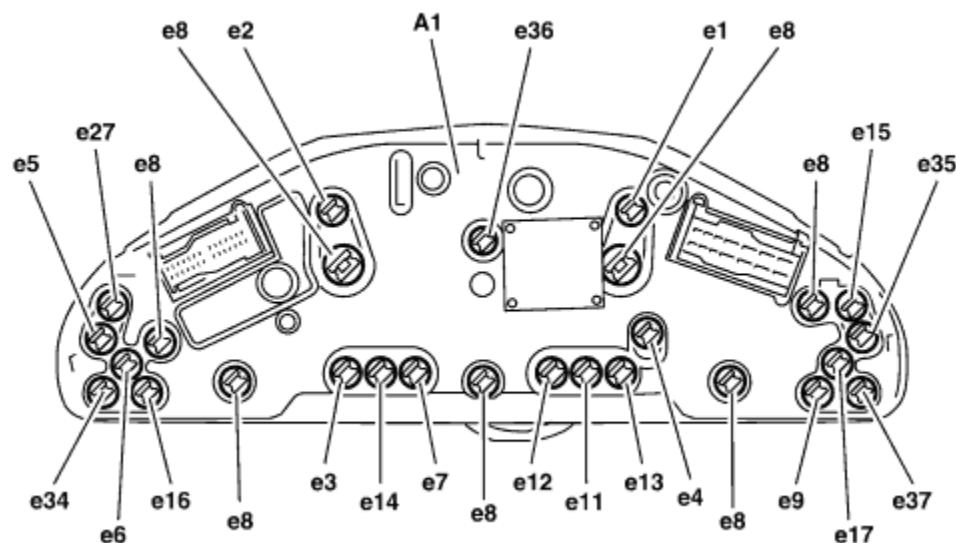

P54.30-0231-05

e35 ETS malfunction indicator lamp

e36 ETS warning lamp

e37 Hydraulic fluid level indicator lamp

Model 210 with multi-function display

A1 Instrument cluster

e1 Left turn signal indicator lamp

e2 Right turn signal indicator lamp

e3 High beam indicator lamp

e4 Fuel reserve indicator lamp

e6 Brake pad wear indicator lamp

e8 Instrument illumination

e9 Seat belt reminder lamp

e15 SRS malfunction indicator lamp

e16 Preglow indicator lamp

e17 ABS malfunction indicator lamp

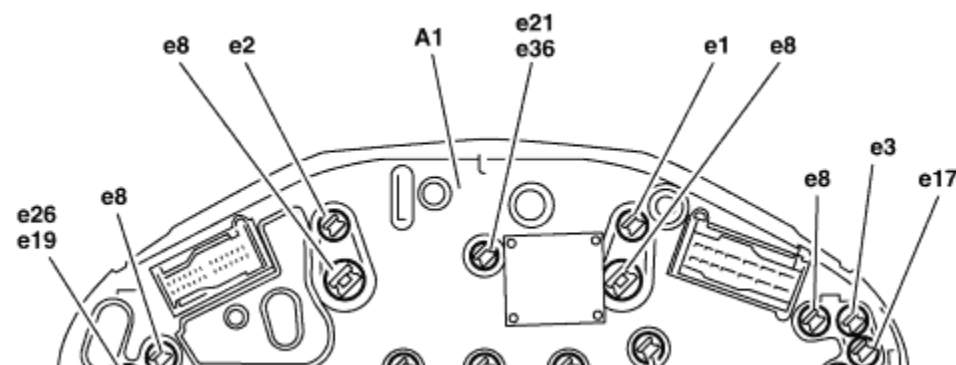

e19 Catalytic converter overheat warning

lamp 

e21 ASR warning lamp

e22 ASR malfunction indicator lamp

e26 "CHECK ENGINE" malfunction
indicator lamp





e35 ETS malfunction indicator lamp

e36 ETS warning lamp

e44 Multi-function display illumination
(white)

e45 Multi-function display illumination (red)

P54.30-0261-05

 	Removal, installation		
1	Disconnect ground lead from battery	 On model 210 insulate the ground lead with cable terminal to prevent unintentional contact between disconnected ground lead and ground point W10	AR54.10-P-0003A
2	Remove instrument cluster	Model 210	AR54.30-P-6015EA
3	Remove bulbs	  Installation: ↓	AR54.30-P-6049-01Z
		Reinstall bulbs	AR54.30-P-6049-02Z
4	Reinstall in opposite order		

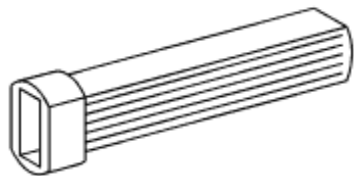

129 589 00 09 00

Bulb removal/installation tool

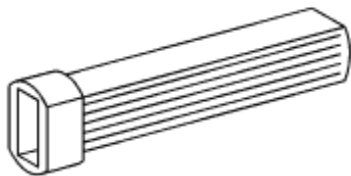

129 589 01 09 00

Bulb removal/installation tool