

MODELS 220.08 /18, 211.08 /28 /09 /29

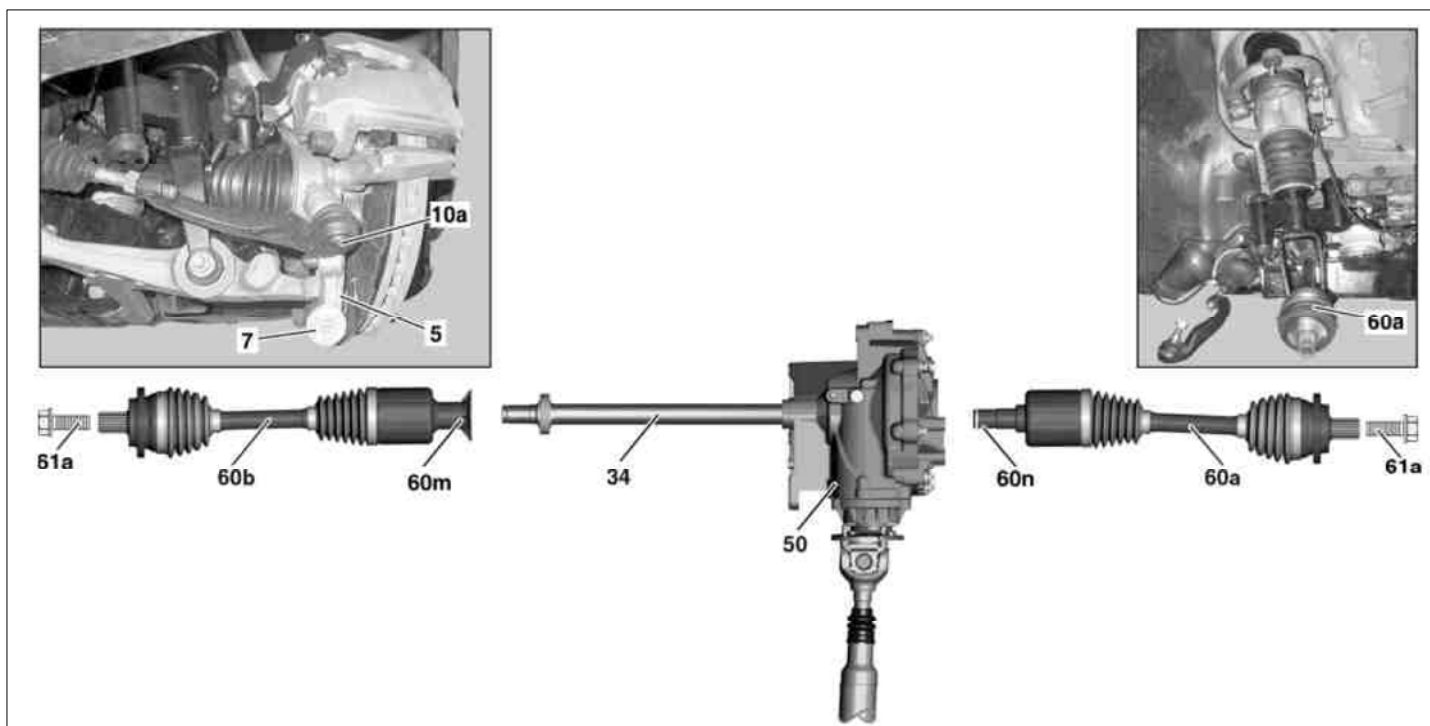

P33.30-2063-09



























Shown on model 211

5 Steering knuckle
 7 Support joint
 10a Tie rod joint
 34 Intermediate shaft

50 Front axle gear
 60a Right front axle shaft
 60b Left front axle shaft

60m Plastic protective ring
 60n Circlip
 61a Hexagon collar bolt

	Remove/install		
Danger!	Risk of injury caused by body parts being jammed or crushed. Risk of injury to skin and eyes caused by brake fluid spraying out at high pressure when working on the SBC brake system	Deactivate SBC brake system using STAR DIAGNOSIS.	AS42.46-Z-0001-01A
Danger!	Risk of death caused by vehicle slipping or toppling off of the lifting platform.	Align vehicle between the columns of the lifting platform and position the four support plates below the hoist support points specified by the vehicle manufacturer.	AS00.00-Z-0010-01A
	When working on the front-end assembly, be careful not to scratch, mark or notch the surfaces of aluminum parts. Otherwise the service life of the parts will be affected		
	Notes on self-locking nuts and bolts	All models	AH00.00-N-0001-01A
	Notes on AIRmatic	Model 211	AH32.22-P-1000-02T
	Notes on AIRmatic	Model 220	AH32.22-P-1000-02I
Installation	Tighten nuts and bolts of chassis components only when vehicle is in the ready-to-drive condition.		
1.1	Deactivate SBC brake system using STAR DIAGNOSIS.	Model 211 The following steps should be run through in STAR DIAGNOSIS: Select menu item "SBC-Sensotronic Brake Control"/"Deactivate 'SBC' system". Then process all the individual steps from top to bottom.	*WE58.40-Z-1013-06A
2	Deflate air spring completely using STAR DIAGNOSIS	Residual pressure in spring strut up to 3.5 bar. STAR DIAGNOSIS diagnosis system	*WE58.40-Z-1013-06A

3	Raise vehicle with lifting platform		
4	Remove front wheels  Remove/install wheels, rotate if necessary		AP40.10-P-4050Z
5	Remove hexagon collar bolt (61a) from right front axle shaft (60a) or left front axle shaft (60b)		AR33.30-P-0620-05P *BA33.30-P-1003-02C
6	Remove lower engine compartment paneling	Model 211 Model 220	AR61.20-P-1105T AR61.20-P-1105M
7	Remove brake caliper from front axle	Model 211 Model 220  Attach brake caliper to vehicle without tension to relieve brake hose so that it is not damaged during repair.  The brake hose does not have to be unscrewed from the brake caliper.	AR42.10-P-0070T AR42.10-P-0070I
8.1	Remove front left or right rpm sensor	Model 220  Removal: Remove rpm sensor of brake caliper and hang up to one side. Do not loosen connector of electrical line to rpm sensor	AR42.30-P-0712I
9	Push supporting joint (7) out of steering knuckle (5)	 After prying off at the supporting joint screw the nut on again, otherwise the steering knuckle may fall down and become damaged. Only unscrew the nut when the steering knuckle is removed. Model 211   Thrust piece  Puller Model 220   Thrust piece  Puller	AR33.20-P-0440-01VM *BA33.20-P-1017-01A *140589006300 *203589003300 AR33.20-P-0440-01IW *BA33.20-P-1017-01A *140589006300 *202589023300
10	Press tie rod joint (10a) out of steering knuckle (5)	  Thrust piece  Puller	AR46.40-P-0200-02IW *BA46.40-P-1001-01E *140589006300 *124589023300
11	Push follower joint of upper transverse control arm out of steering knuckle (5)	 The follower joint must be removed, otherwise the follower joint is damaged by hard pulling or excessive angles.  Model 211  Thrust piece M10* 1.5  Puller Model 220  Thrust piece M10* 1.5  Puller	*BA33.20-P-1018-01A AR33.20-P-0500-01VM *210589046300 *202589023300 AR33.20-P-0500-01N *210589046300 *202589023300
12	Detach stabilizer bar link rod from stabilizer bar	Model 211  Model 220 	AR32.20-P-0300-02VM *BA32.20-P-1002-02B AR32.20-P-0300-02VB *BA32.20-P-1002-02H
13.1	Detach front suspension strut from transverse control arm	Model 211 	AR33.20-P-0500-06VM *BA32.25-P-1012-04B
14	Guide steering knuckle (5) out of supporting joint (7)		
15	Remove steering knuckle (5) and move right front axle shaft (60a) or left front axle shaft (60b) out of front axle shaft flange	 Avoid damaging the rubber boots on the front axle shaft and the rubber boot on the supporting joint (7).  If necessary to loosen the front axle shafts, screw in the hexagon collar bolt (61a) a few threads again and hammer out the front axle shaft slightly using a rubber hammer.	

16.1	Push out right front axle shaft (60a) and remove	<p>ⓘ Do not damage the rubber boots and rpm sensor rotor. To avoid damaging the wheel bearings, the vehicle must not be moved on its wheels with the front axle shaft removed.</p> <p>ⓘ Mount the ⓘ chain on the pot of the right front axle shaft (60a). Make sure that ⓘ chain is mounted as close as possible to front axle gear (50).</p> <p>ⓘ Chain</p>	AR33.30-P-0620-02P *203589036300
16.2	Knock out and remove left front axle shaft (60b)	<p>ⓘ Do not damage the plastic guard ring (60m), rubber boots and rpm sensor rotor. To avoid damaging the wheel bearings, the vehicle must not be moved on its wheels with the front axle shaft removed.</p>	AR33.30-P-0620-03P
	Check		
17	Check joints and rubber boots of front axle shaft for leaks and damage	<p>ⓘ New front axle shaft must be installed if damaged is found.</p>	
18	Install in the reverse order		
19	Charge air spring with STAR DIAGNOSIS at design level.	<p>ⓘ During recharging the wheels should never be in contact with the floor; refilling with the suspension compressed leads to destruction of the air suspension bellows in the air suspension strut.</p> <p>ⓘ Pressurize to 5 bar. STAR DIAGNOSIS diagnosis system</p>	*WE58.40-Z-1013-06A
20.1	Activate SBC brake system using STAR DIAGNOSIS	Model 211	*WE58.40-Z-1013-06A
		<p>ⓘ The following steps should be run through in STAR DIAGNOSIS: Select "Initial startup after repair"/"Remove/install brake pads" menu item. Then process all the individual steps from top to bottom.</p>	

Front axle shaft

Number	Designation			Model 211.08/09/ 28/29	Model 220.083/084/087/ 183/184/187
BA33.30-P-1003-02C	Collar bolt, front axle shaft to front axle shaft flange	1st stage	Nm	70	70
		2nd stage	fi °	90	90

Wheel control, hub

Number	Designation			Model 211.08/09/ 28/29	Model 220.08/18
BA33.20-P-1017-01A	Self-locking nut, supporting joint to steering knuckle	1st stage	Nm	70	70
		2nd stage	fi °	50	50
BA33.20-P-1018-01A	Self-locking nut, upper wishbone follower joint to steering knuckle	1st stage	Nm	20	20
		2nd stage	fi °	60	90

Tie rod

Number	Designation			Models 220.083/ 084/087/ 183/184/ 187	Model 211.08/09/ 28/29
BA46.40-P-1001-01E	Self-locking nut, tie rod to steering knuckle	Stage 1	Nm	55	55
		Stage 2	ft °	-	-

Nm Front axle torsion strut

Number	Designation			Model 211.080/082/ 083/084/087/ 089/092/280/ 282/283/284/ 287/289/292
BA32.20-P-1002-02B	Self-locking nut of connecting rod to torsion bar	M10	Nm	-
		M10' 1.5	Nm	-
		M12' 1.5	Nm	95
		M14' 1.5	Nm	-

Nm Front axle torsion strut

Number	Designation		Models 220.083/ 084/087/ 183/184/ 187
BA32.20-P-1002-02H	Nut, link rod to stabilizer bar	Nm	95

Nm Struts

Number	Designation		Model 211.08/ 09/28/29
BA32.25-P-1012-04B	Nut of shock-absorber strut to transverse control arm	Nm	162

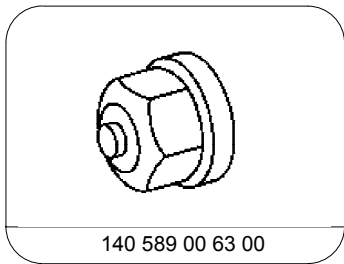

140 589 00 63 00

Thrust piece

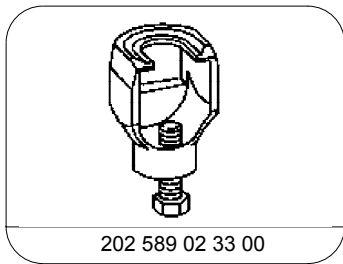

202 589 02 33 00

Puller

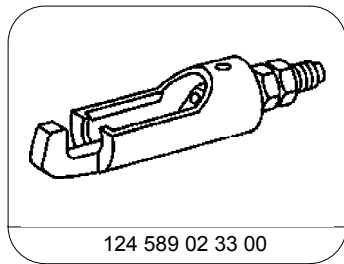

124 589 02 33 00

Puller

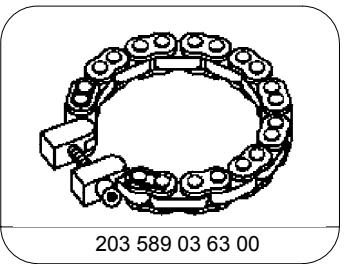

203 589 03 63 00

Chain

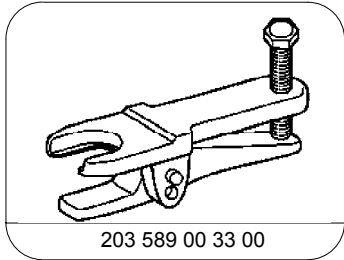

203 589 00 33 00

Puller

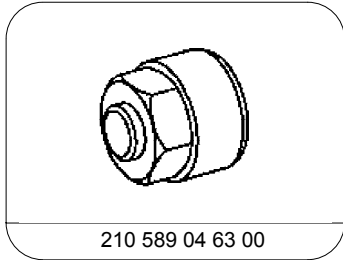

210 589 04 63 00

Thrust washer M 10x1.5

Workshop equipment/MB testers (see Workshop Equipment Manual)

WE58.40-Z-1013-06A

STAR DIAGNOSIS Compact diagnosis system for passenger cars, order number 6511 1801 00