

- Parts list -

Mode	BM mode	Market	
VIN/mod. des.	WDB2112831X202363	BM overview	E 500 4MATIC
VIN	WDBUH83J96X202363	Catalog	64V
Sales designation		Group	41 PROPELLER SHAFT
Assortment class	PC	Sub-group	015 PROPELLER SHAFT

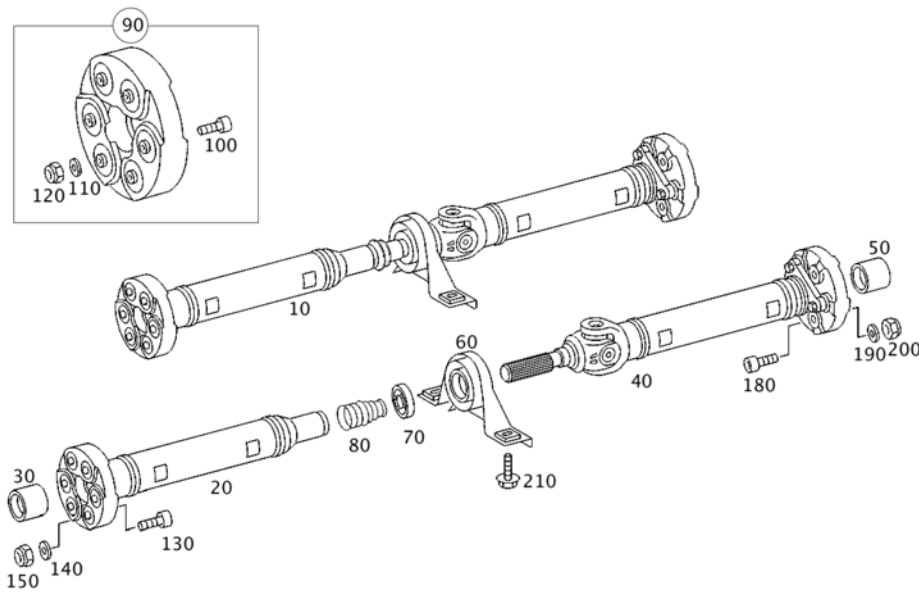



































Image ID: drawing_B41015000078













Copyright 2019-02-14 Daimler AG

Item	Part number	Designation/additional information	Qty
10	A 211 410 83 06	PROPELLER SHAFT Code: M113+M50+M005+494;	1
20	A 211 410 11 01	* PROPELLER SHAFT, FRONT FRONT Code: M113+M50; [417] IS NO LONGER DELIVERED, ORDER DELIVERY CONT...	1
30	A 124 410 07 32	* CENTERING SLEEVE FRONT Code: M113+M50+M005+494;	1

Item	Part number	Designation/additional information	Qty
40	A 211 410 07 02	* PROPELLER SHAFT REAR  Code: M113+M50;  [417] IS NO LONGER DELIVERED, ORDER DELIVERY CONT...	1
60	A 211 410 02 81	* CENTER SUPPORT BEARING  Code: M113+M50;	1
60	A 211 410 02 81	* CENTER SUPPORT BEARING  Code: M113+M50+423;	1
60	A 211 410 02 81	* CENTER SUPPORT BEARING  Code: M113+M50+M005+494;	1
70	A 008 981 43 25	* BALL BEARING  Code: -(M001/M63/M629);	1
80	A 202 411 04 97	* BOOT  Code: (802/803/804/805/806/807)+-(M55/M63/M629);	1
90	A 170 410 01 15	FLEXIBLE JOINT DISC (PARTS KIT), FRONT  Code: M113+M50+M005+494;	1
90	A 202 410 18 15	FLEXIBLE JOINT DISC PARTS KIT FRONT  Code: M113+M50+M005+494;	1
90	A 202 410 18 15	FLEXIBLE JOINT DISC (PARTS KIT), REAR  Code: M113+M50+M005+494;	1
90	A 170 410 01 15	FLEXIBLE JOINT DISC (PARTS KIT), REAR  Code: M113+M50+M005+494;	1
100	A 007 990 00 04	* CAP BOLT WITH SOCKET FLEXIBLE JOINT DISC TO FRONT PROPELLER SHAFT; M12X1.5X65  Code: M113+M50;	3
100	A 007 990 00 04	* CAP BOLT WITH SOCKET FLEXIBLE JOINT DISC TO FRONT PROPELLER SHAFT; M12X1.5X65  Code: M113+M50+423;	3
100	A 011 990 11 04	* CAP BOLT WITH SOCKET FLEXIBLE JOINT DISC TO FRONT PROPELLER SHAFT; M12X65  Code: M113+M50+423;	3
100	A 006 990 99 04	* CAP BOLT WITH SOCKET FLEXIBLE JOINT DISC TO FRONT PROPELLER SHAFT; M12 X1.5 X 60  Code: M113+M50+M005+494;	3
100	A 011 990 10 04	* CAP BOLT WITH SOCKET FLEXIBLE JOINT DISC TO FRONT PROPELLER SHAFT; M12X60  Code: M113+M50+M005+494;	3
100	A 007 990 00 04	* CAP BOLT WITH SOCKET FLEXIBLE JOINT DISC TO REAR PROPELLER SHAFT; M12X1.5X65  Code: M113+M50;	3
100	A 007 990 00 04	* CAP BOLT WITH SOCKET FLEXIBLE JOINT DISC TO REAR PROPELLER SHAFT; M12X1.5X65  Code: M113+M50+423;	3

Copyright 2019-02-14 Daimler AG

Item	Part number	Designation/additional information	Qty
100	A 011 990 11 04	* CAP BOLT WITH SOCKET FLEXIBLE JOINT DISC TO REAR PROPELLER SHAFT; M12X65  Code: M113+M50+423;	3
100	A 006 990 99 04	* CAP BOLT WITH SOCKET FLEXIBLE JOINT DISC TO REAR PROPELLER SHAFT; M12 X1.5 X 60  Code: M113+M50+M005+494;	3
100	A 011 990 10 04	* CAP BOLT WITH SOCKET FLEXIBLE JOINT DISC TO REAR PROPELLER SHAFT; M12X60  Code: M113+M50+M005+494;	3
110	A 006 990 45 40	* WASHER FLEXIBLE JOINT DISC TO FRONT PROPELLER SHAFT  Code: M646/M647/M628/M271/M112/M113+-M001;	3
110	A 006 990 45 40	* WASHER FLEXIBLE JOINT DISC TO FRONT PROPELLER SHAFT  Code: M113+M50+423;	3
110	A 006 990 45 40	* WASHER FLEXIBLE JOINT DISC TO FRONT PROPELLER SHAFT  Code: M113+M50+M005+494;	3
110	A 006 990 45 40	* WASHER FLEXIBLE JOINT DISC TO REAR PROPELLER SHAFT  Code: M646/M647/M628/M271/M112/M113+-M001;	3
110	A 006 990 45 40	* WASHER FLEXIBLE JOINT DISC TO REAR PROPELLER SHAFT  Code: M113+M50+423;	3
110	A 006 990 45 40	* WASHER FLEXIBLE JOINT DISC TO REAR PROPELLER SHAFT  Code: M113+M50+M005+494;	3
120	A 005 990 19 51	* HEXAGON NUT FLEXIBLE JOINT DISC TO FRONT PROPELLER SHAFT; M12X1.5  Code: M646/M647/M628/M271/M112/M113+-M001;	3
120	A 005 990 19 51	* HEXAGON NUT FLEXIBLE JOINT DISC TO FRONT PROPELLER SHAFT; M12X1.5  Code: M113+M50+423;	3
120	A 002 990 62 54	* HEX. NUT W CLAMPING PART FLEXIBLE JOINT DISC TO FRONT PROPELLER SHAFT; M12  Code: M113+M50+423;	3
120	A 005 990 19 51	* HEXAGON NUT FLEXIBLE JOINT DISC TO FRONT PROPELLER SHAFT; M12X1.5  Code: M113+M50+M005+494;	3
120	A 002 990 62 54	* HEX. NUT W CLAMPING PART FLEXIBLE JOINT DISC TO FRONT PROPELLER SHAFT; M12  Code: M113+M50+M005+494;	3
120	A 005 990 19 51	* HEXAGON NUT FLEXIBLE JOINT DISC TO REAR PROPELLER SHAFT; M12X1.5  Code: M646/M647/M628/M271/M112/M113+-M001;	3
120	A 005 990 19 51	* HEXAGON NUT FLEXIBLE JOINT DISC TO REAR PROPELLER SHAFT; M12X1.5  Code: M113+M50+423;	3

Item	Part number	Designation/additional information	Qty
120	A 002 990 62 54	* HEX. NUT W CLAMPING PART FLEXIBLE JOINT DISC TO REAR PROPELLER SHAFT; M12  Code: M113+M50+423;	3
120	A 005 990 19 51	* HEXAGON NUT FLEXIBLE JOINT DISC TO REAR PROPELLER SHAFT; M12X1.5  Code: M113+M50+M005+494;	3
120	A 002 990 62 54	* HEX. NUT W CLAMPING PART FLEXIBLE JOINT DISC TO REAR PROPELLER SHAFT; M12  Code: M113+M50+M005+494;	3
130	A 007 990 00 04	CAP BOLT WITH SOCKET PROPELLER SHAFT TO TRANSMISSION; M12X1.5X65  Code: M113/M646/M646+M006+M010/M647/M272+M35/M648+...	3
130	A 011 990 10 04	CAP BOLT WITH SOCKET PROPELLER SHAFT TO TRANSMISSION; M12X60  Code: M005+(M113/M642/M273);	3
140	A 006 990 45 40	WASHER PROPELLER SHAFT TO TRANSMISSION  Code: M112/M113/M271/M272/M646/M647/M648+M013/M642+...	3
140	A 006 990 45 40	WASHER PROPELLER SHAFT TO TRANSMISSION  Code: M005+(M113/M642/M273);	3
150	A 005 990 19 51	HEXAGON NUT PROPELLER SHAFT TO TRANSMISSION; M12X1.5  Code: M112/M113/M271/M272/M646/M647/M648+M013/M642+...	3
150	A 002 990 62 54	HEX. NUT W CLAMPING PART PROPELLER SHAFT TO TRANSMISSION; M12  Code: M005+(M113/M642/M273);	3
180	A 011 990 10 04	CAP BOLT WITH SOCKET PROPELLER SHAFT TO REAR AXLE; M12X60  Code: M005+(M113/M272/M273);	3
190	A 006 990 45 40	WASHER PROPELLER SHAFT TO REAR AXLE  Code: M112/M113/M271/M272/M646/M647/M648+M013/M642+...	3
190	A 006 990 45 40	WASHER PROPELLER SHAFT TO REAR AXLE  Code: M005+(M112/M113/M272/M273/M642);	3
200	A 002 990 62 54	HEX. NUT W CLAMPING PART PROPELLER SHAFT TO REAR AXLE; M12  Code: M005+(M112/M113/M272/M273/M642);	3
210	N 910143 008002	HEXALOBULAR BOLT INTERMEDIATE BEARING TO FIXTURE; M8X25	2
210	N 910143 008003	HEXALOBULAR BOLT INTERMEDIATE BEARING TO FIXTURE; M8X30	2