

- Parts list -

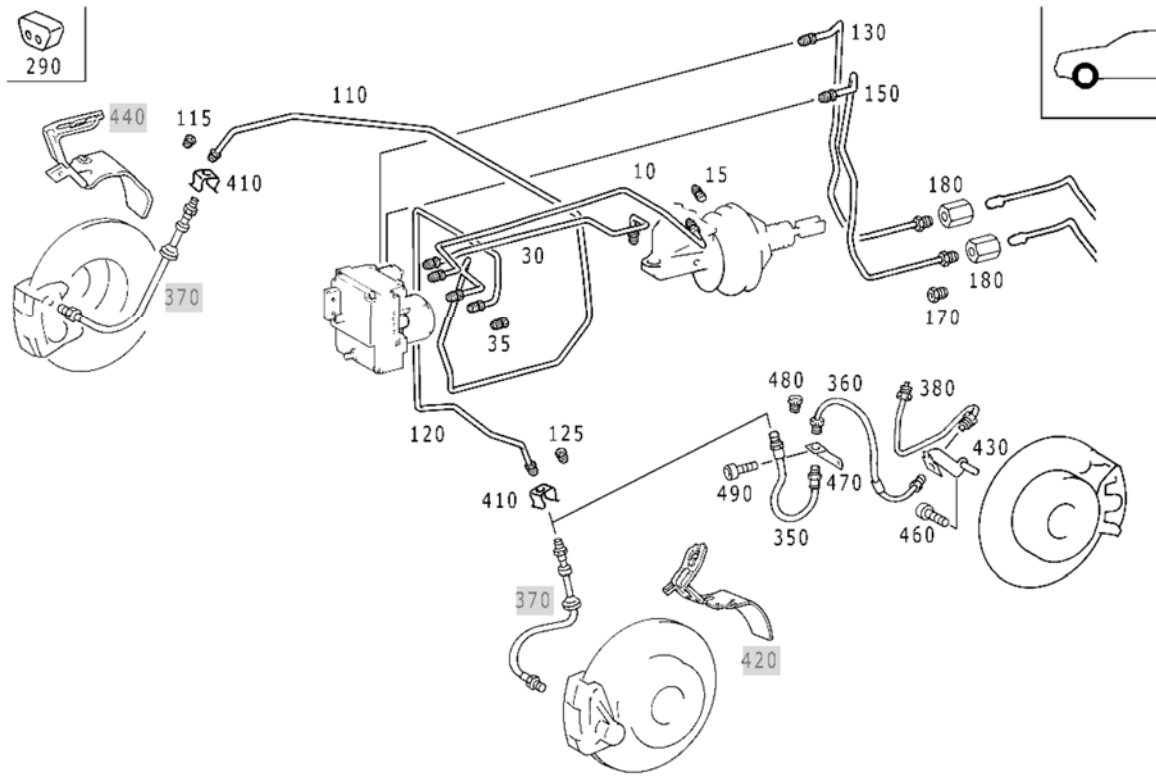















Mode	BM mode	Market	
VIN/mod. des.	WDB2100821X041078	BM overview	E 320 4MATIC
VIN	WDBJF82J8YX041078	Catalog	66Y
Assortment class	PC	Group	42 BRAKES
		Sub-group	090 BRAKE LINES



Copyright 2020-10-18 Daimler AG



Image ID: drawing_B42090000304

Item	Part number	Designation/additional information	Qty
------	-------------	------------------------------------	-----

Item	Part number	Designation/additional information	Qty
10	A 123 420 60 28 	LINE FROM MASTER CYLINDER,CONNECTION "V",TO HYDRAULIC UNIT,CONNECTION: "V"; 580 MM  Code: M111/M112;  [409] TO BE ADAPTED DURING ASSEMBLY	1
15	A 140 997 06 34 	RETAINING SCREW M12X1  Code: M112/M611/M612;	2
30	A 123 420 59 28 	LINE FROM MASTER CYLINDER,CONNECTION "H",TO HYDRAULIC UNIT,CONNECTION: "H"  Code: M111/M112/M113;  [409] TO BE ADAPTED DURING ASSEMBLY	1
35	A 140 997 06 34 	RETAINING SCREW M12X1  Code: M112;	2
110	A 123 420 74 28	LINE FROM HYDRAULIC UNIT TO RIGHT FRONT WHEEL  Code: M112+M005;  [409] TO BE ADAPTED DURING ASSEMBLY	1
115	A 000 428 04 72	NUT M10X1 Optionally: A1269970134	2
115	A 126 997 01 34	RETAINING SCREW M10X1 Optionally: A0004280472	2
120	A 123 420 65 28	LINE FROM HYDRAULIC UNIT TO LEFT FRONT WHEEL  Code: M112+M005;  [409] TO BE ADAPTED DURING ASSEMBLY	1
125	A 000 428 04 72	NUT M10X1 Optionally: A1269970134	2
125	A 126 997 01 34	RETAINING SCREW M10X1 Optionally: A0004280472	2
130	A 123 420 66 28	LINE FROM HYDRAULIC UNIT TO ADAPTER FITTING,REAR RIGHT  [409] TO BE ADAPTED DURING ASSEMBLY	1
150	A 123 420 65 28	LINE FROM HYDRAULIC UNIT TO ADAPTER FITTING,REAR LEFT  [409] TO BE ADAPTED DURING ASSEMBLY	1

Item	Part number	Designation/additional information	Qty
170	A 000 428 04 72	NUT M10X1 Optionally: A1269970134	2
170	A 126 997 01 34	RETAINING SCREW M10X1 Optionally: A0004280472	2
170	A 126 997 01 34	RETAINING SCREW M10X1 Optionally: A0004280472	2
170	A 000 428 04 72	NUT M10X1 Optionally: A1269970134	2
170	A 000 428 04 72	NUT M10X1 Optionally: A1269970134	2
170	A 126 997 01 34	RETAINING SCREW M10X1 Optionally: A0004280472	2
170	A 000 428 04 72	NUT M10X1 Optionally: A1269970134	2
170	A 126 997 01 34	RETAINING SCREW M10X1 Optionally: A0004280472	2
170	A 000 428 04 72	NUT M10X1 Optionally: A1269970134	2
170	A 126 997 01 34	RETAINING SCREW M10X1 Optionally: A0004280472	2
170	A 000 428 04 72	NUT M10X1 Optionally: A1269970134	2
170	A 126 997 01 34	RETAINING SCREW M10X1 Optionally: A0004280472	2
170	A 000 428 04 72	NUT M10X1 Optionally: A1269970134	2
170	A 126 997 01 34	RETAINING SCREW M10X1 Optionally: A0004280472	2
180	A 121 429 01 34	HEXAGON SPACER ELEMENT M10	2
290	A 123 428 00 85	SPACER SPACING OF BRAKE LINES	1

Item	Part number	Designation/additional information	Qty
350	A 210 428 26 00	BRAKE HOSE BETWEEN BRAKE LINE AND BRAKE HOSE  Code: (M112/M113)+M005;	2
360	A 210 428 05 35	BRAKE HOSE FROM LEFT AND RIGHT BRAKE HOSES TO LEFT AND RIGHT CALIPERS Replaced by: A 168 428 03 35  Code: (M112/M113)+M005;	2
360	A 168 428 03 35	BRAKE HOSE FROM LEFT AND RIGHT BRAKE HOSES TO LEFT AND RIGHT CALIPERS  Code: (M112/M113)+M005;	2
380	A 210 420 25 26	LINE FROM BRAKE HOSE TO LEFT FRONT CALIPER  Code: M112+M005;	1
380	A 210 420 26 26	LINE FROM BRAKE HOSE TO RIGHT FRONT CALIPER  Code: M112+M005;	1
410	A 000 428 06 73	RETAINING SPRING BRAKE LINE TO BRAKE HOSE  Code: (M112/M113)+M005;	6
430	A 210 420 02 86	BRACKET LEFT BRAKE HOSE  Code: M112+M005;	1
430	A 210 420 03 86	BRACKET RIGHT BRAKE HOSE  Code: M112+M005;	1
460	N 007984 008041	SCREW BRACKET TO CALIPER; M8X60  Code: (M112/M113)+M005;	2
470	A 210 428 08 40	BRACKET LEFT BRAKE HOSE  Code: (M112/M113)+M005;	1
470	A 210 428 07 40	BRACKET RIGHT BRAKE HOSE  Code: (M112/M113)+M005;	1
480	A 000 428 04 72	NUT M10X1  Code: (M112/M113)+M005; Optionally: A1269970134	4

Item	Part number	Designation/additional information	Qty
480	A 126 997 01 34	RETAINING SCREW M10X1  Code: (M112/M113)+M005; Optionally: A0004280472	4
490	N 000912 006159	CAP BOLT BRACKET TO STEERING KNUCKLE; M6X16  Code: (M112/M113)+M005;	4