

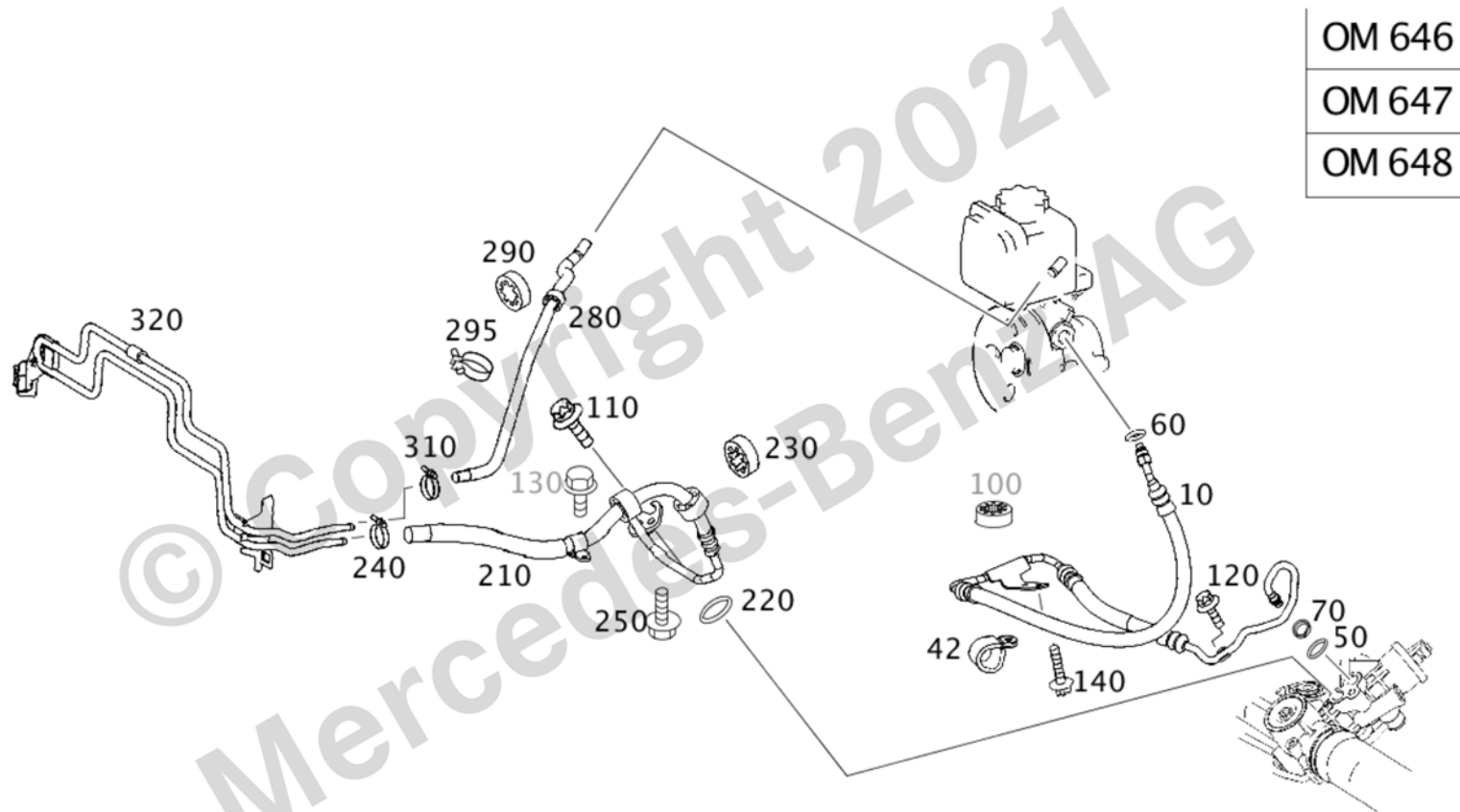













Parts Information















## - Parts list -

<b>Vehicle</b>	WDB2110041A728804 (64U)	E 200 CDI	
<b>Color</b>	723 - cubanitsilber metallic	<b>Equipment</b>	331 - Stoff anthrazit
<b>Assortment class</b>	PC	<b>Group</b>	46 STEERING
<b>Sub-group</b>	063 DIESEL VEHICLES LINE SCOPE		



Item	Part number	Designation/additional information	Qty
10	A 211 466 06 81  	HOSE FROM PUMP TO STEERING  Code: M646+-M010;  Fault location 46531	1
42	N 916016 020202 	* CLAMP HIGH-PRESSURE EXPANSION HOSE HOLDER; 20/20	1
50	A 015 997 22 45 	* O-RING  Code: M646;	1
60	A 028 997 32 48 	* SEALING RING DELIVERY LINE TO PUMP; 7.65 X 1.63 MM  Code: M271/M642+-M005/M646/M647/M648;	1
70	A 000 992 16 80 	* SUPPORT RING  [417] IS NO LONGER DELIVERED, ORDER DELIVERY CONTENTS  Code: M646;	1
110	N 000000 003853	HEXALOBULAR BOLT HIGH-PRESSURE AND LOW-PRESSURE HOSES TO STEERING; M8X16	1
120	N 000000 001114 	HEXALOBULAR BOLT HIGH-PRESSURE HOSE TO HOUSING STEERING LEFT; M6X15	1
140	N 000000 001114	HEXALOBULAR BOLT HIGH-PRESSURE TO ENGINE OIL SUMP; M6X15  Code: M646/M648/(M112/M113/M642)+-(M005/M156+M63);	2

Parts Information

Item	Part number	Designation/additional information	Qty
210	A 211 466 20 81  	HOSE FROM STEERING TO COOLING PIPE  [001176, 001954] OBSERVE WIS  Code: -(M628/M005/M63);  Fault location 46533	1
220	A 027 997 95 48 	* SEALING RING LOW PRESSURE LINE TO STEERING  Code: -(M005/M63);	1
230	A 116 466 12 82 	* RUBBER RING CHAFE PROTECTION, PRESSURE LINE  Code: -(M628/M005);	2
240	A 005 997 27 90	HOSE CLAMP LOW-PRESSURE HOSE TO COOLING PIPE  Code: -(M156+M63);	1
250	A 140 990 06 36	SCREW LOW PRESSURE HOSE TO CARRIER; M5X14	1
280	A 211 466 64 81 	HOSE FROM COOLING PIPE TO PUMP  Code: M646+-M010;	1
290	A 123 328 89 81 	* RUBBER RING PROTECTION AGAINST SCORING FOR HOSE  Code: M646;	1

Parts Information

Item	Part number	Designation/additional information	Qty
295	A 005 997 27 90	HOSE CLAMP HOSE TO COOLER PIPE AND PUMP ☒ Code: M646/M647/M648;	1
310	A 005 997 27 90	HOSE CLAMP LOW PRESSURE HOSE TO COOLING LINE ☒ Code: -(M156+M63);	1
320	A 211 466 12 24	LINE TO COOLING MODULE ☒ Code: M646+-M010;	1