

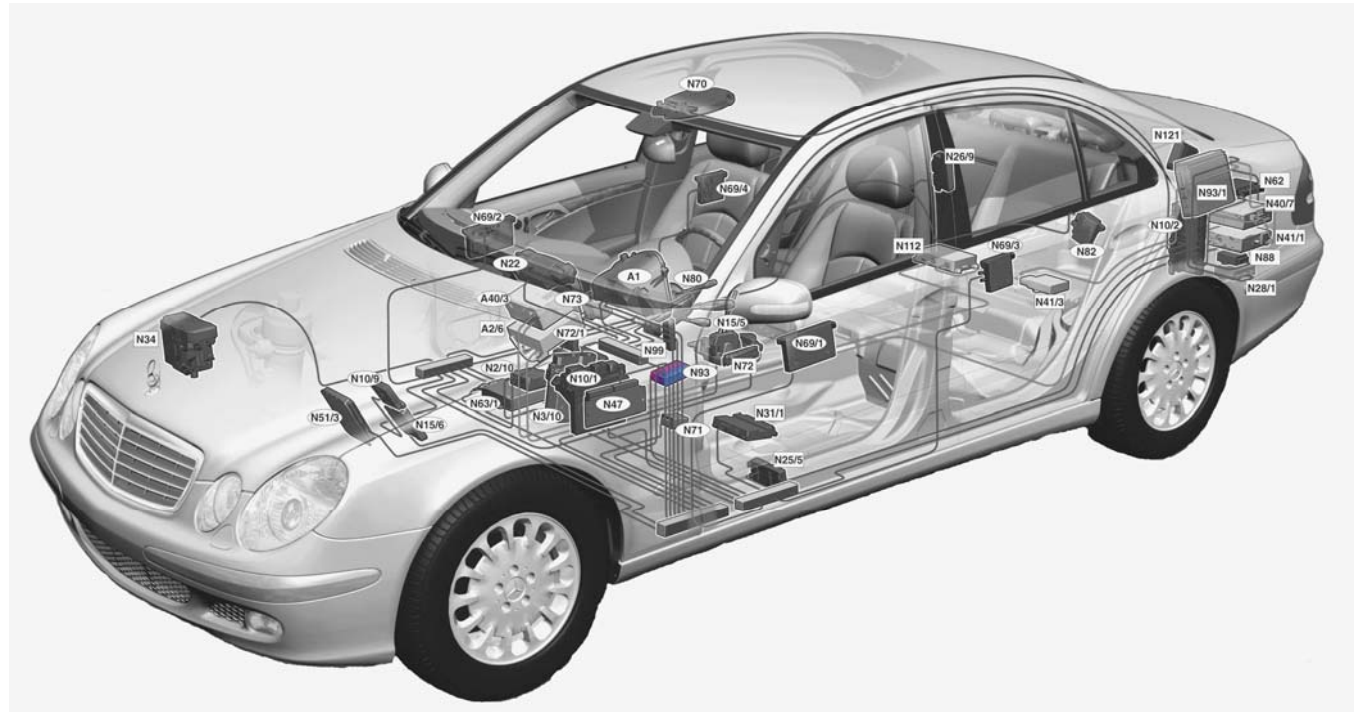

Mercedes-Benz

# W211 Networking



These technical training materials are current as of the date noted on the materials, and may be revised or updated without notice. Always check for revised or updated information.

To help avoid personal injury to you or others, and to avoid damage to the vehicle on which you are working, you must always refer to the latest Mercedes-Benz Technical Publication and follow all pertinent instructions when testing, diagnosing or making repair. Illustrations and descriptions in this training reference are based on preliminary information and may not correspond to the final US version vehicles. Refer to the official introduction manual and WIS when available.

*Copyright Mercedes-Benz USA, LLC, 2002*

*Reproduction by any means or by any information storage and retrieval system or translation in whole or part is not permitted without written authorization from Mercedes-Benz USA, LLC or its successors.*

*Published by Mercedes-Benz USA, LLC*

*Printed in U. S.A.*

# Communication Networks

The W211 uses many control modules that share information, control consumers and self diagnostics. There are 3 vehicle communication networks and 1 dedicated diagnostic network.

CAN B - Interior databus (sometimes called body CAN)

CAN C - Engine databus (sometimes called chassis CAN)

MOST - Digital fiber optic databus (replaces D2B)

CAN D - Diagnostic databus

# W211 Networking Diagram

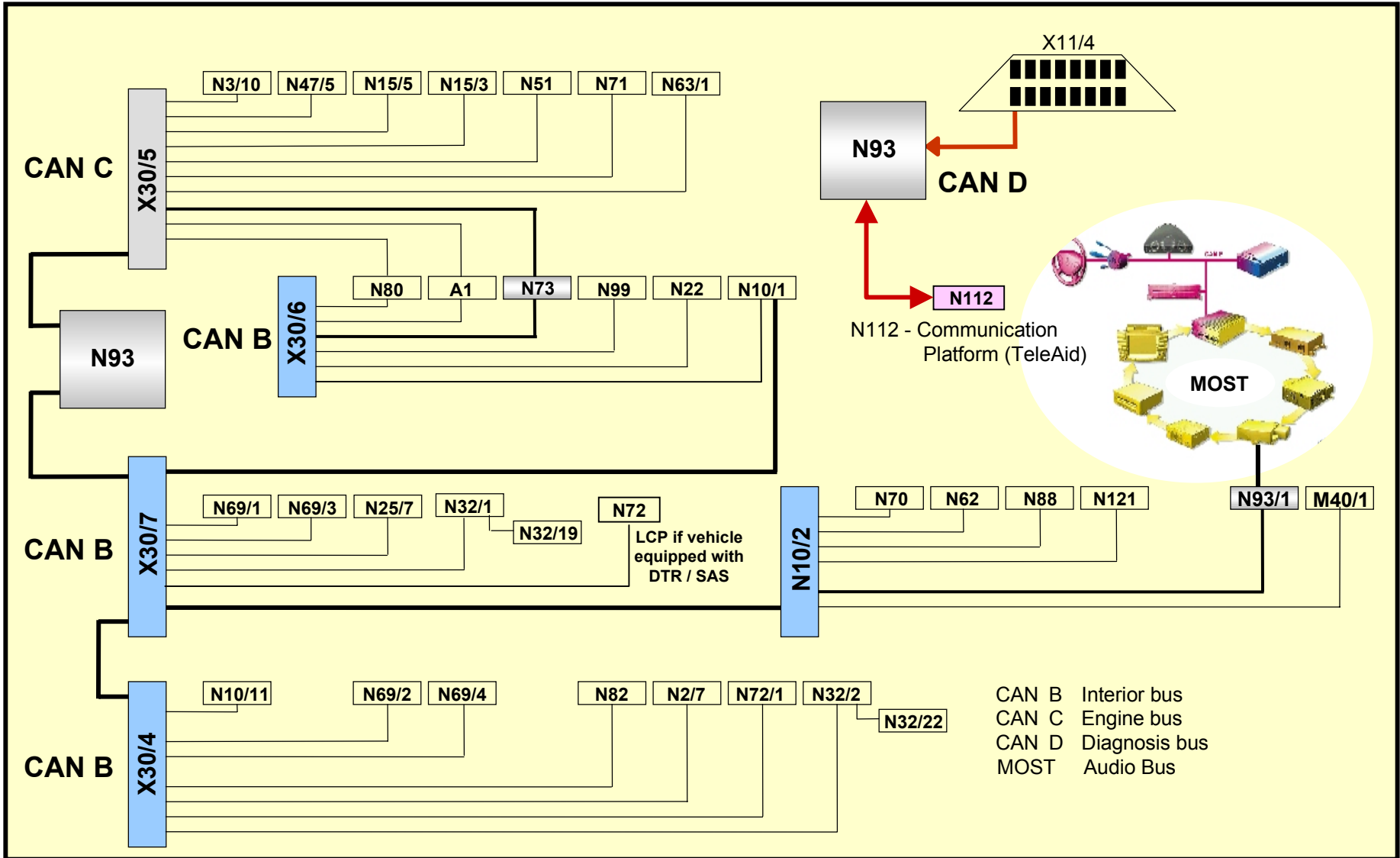

# W211 Networking Legend

## CAN C

N3/10	ME-SFI Control Module
N15/3	ETC - Electronic Transmission Control
N15/5	ESM - Electronic Selector Module
N47/5	ESP - Electronic Stability Program
N51	SAS - Semi-Active Air Suspension
N63/1	DTR - Distronic Control Module
N71	HRA - Headlamp Range Adjustment
N93	CGW - Central Gateway Module

## CAN B

M40/1	Pneumatic Pump of Dynamic Seat
N2/7	Supplemental Restraint System
N10/1	SAM-D - Driver-side
N10/2	SAM-R - Rear
N10/11	SAM-P - Passenger-side
N22	AAC - Automatic Air Conditioning Control
N25/7	HS and Seat Ventilation Control Module
N32/1	ESA - Left Front Seat Adjustment
N32/2	ESA - Right Front Seat Adjustment

N32/19	Left Front Dynamic Seat Control
N32/22	Right Front Dynamic Seat Control
N62	PTS - Parktronic Control
N69/1	DCM - Left Front Door Control Module
N69/2	DCM - Right Front Door Control Module
N69/3	DCM - Left Rear Door Control Module
N69/4	DCM - Right Rear Door Control Module
N70	OCP - Overhead Control Panel
N72/1	UCP - Upper Control Panel
N82	BCM - Battery Control Module
N88	TPC - Tire Pressure Monitor Control Module
N93/1	AGW - Audio Gateway Control Module
N99	SWH - Steering Wheel Heater
N121	RTL - Remote Trunk Locking Control Module

## CAN C & B

A1	ICM - Instrument Cluster
N73	EIS - Electronic Ignition Switch Control
N80	SCM - Steering Column Module
N93	CGM - Central Gateway Module

# Central Gateway Module (N93)

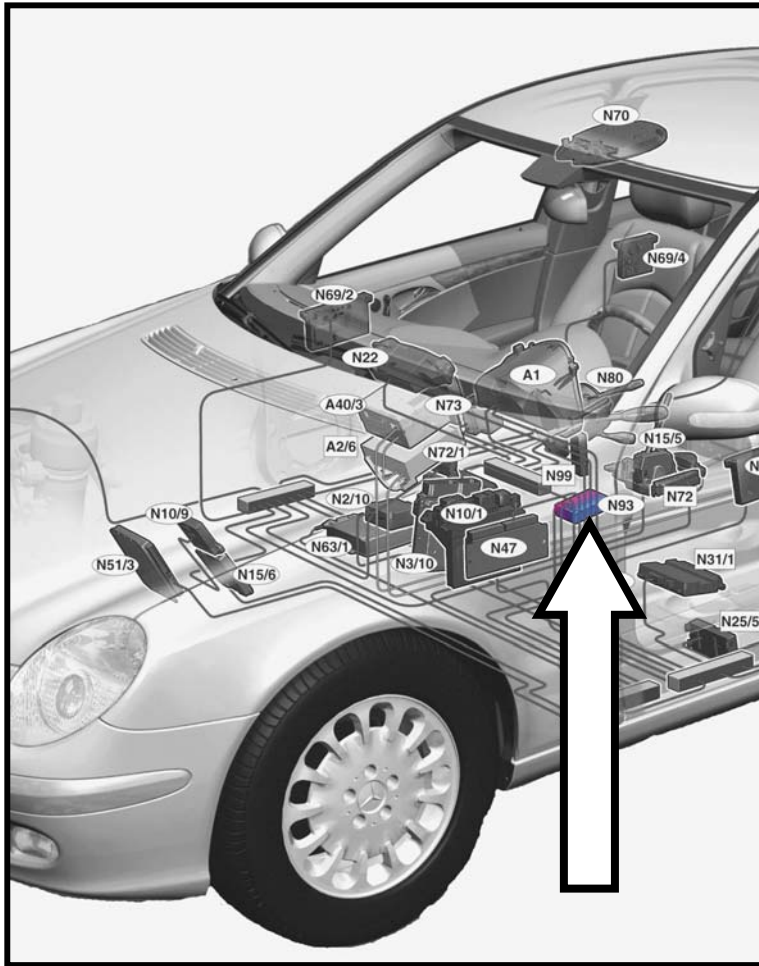

Location: Drivers under dash panel

# CGW (N93)

- CGW is the primary gateway between CAN C and CAN B
- Version coding known from EIS (N73) is now contained in CGW (N93)
- CGW contains FSS plus maintenance programs, no longer in ICM
- CGW module replacement
  - CGW module attempts to adapt to vehicle control modules
  - System diagnosis knowledge base updated by flashing
- Incorporates system diagnosis functions
  - CGW replaces system diagnosis module known from (R230)
  - Monitors, evaluates and performs logic assessments of CAN B related components (later production CAN C will be included)

# System Diagnosis Functions

- Monitors CAN B control modules for proper operation and faults
  - Provides DTC's related to CAN B communication problems
  - Monitors inputs & outputs of CAN B control modules
- Determines impaired functions and suspicious components
  - Narrows down the list of suspicious components
  - Puts suspicious components in order of likelihood
- Informs DAS via X11/4
  - Requests component activation for evaluation
  - Results of diagnosis
- Provides information on the cause of an ATA triggering event



# CAN C Connector (X30/5)

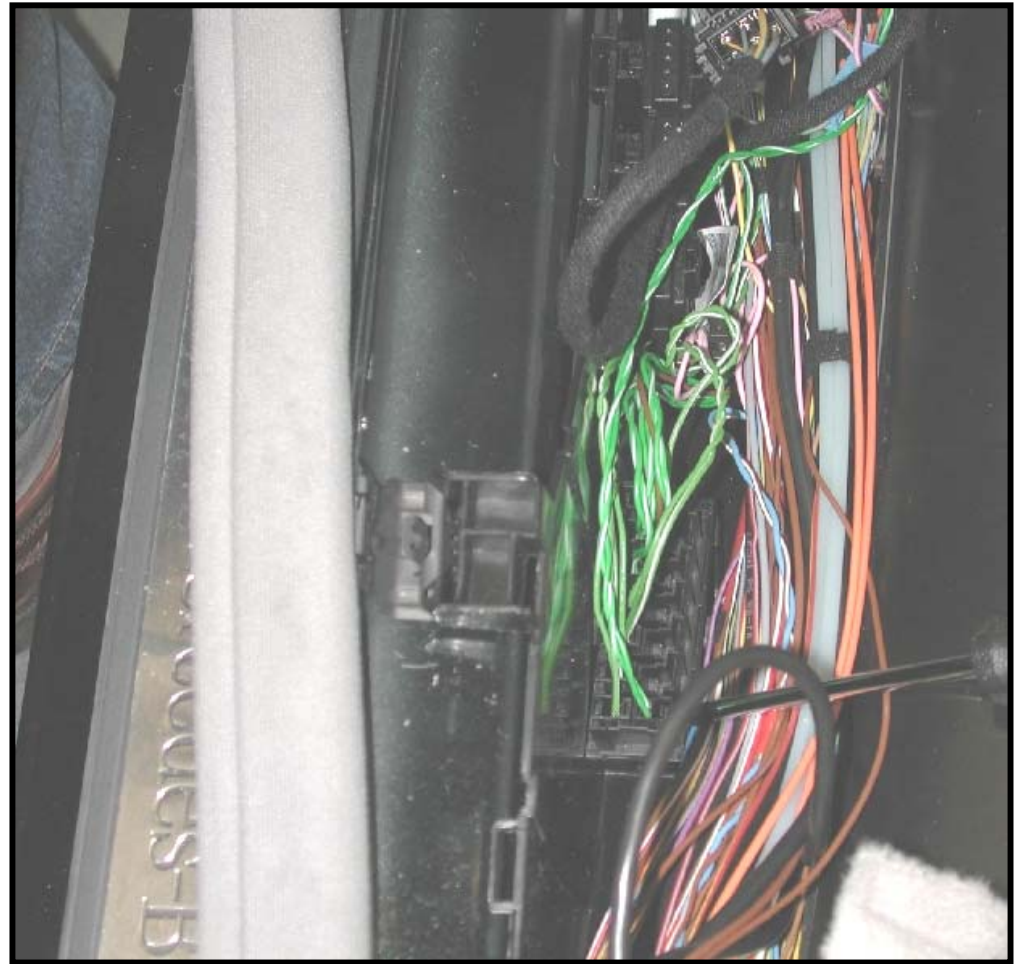
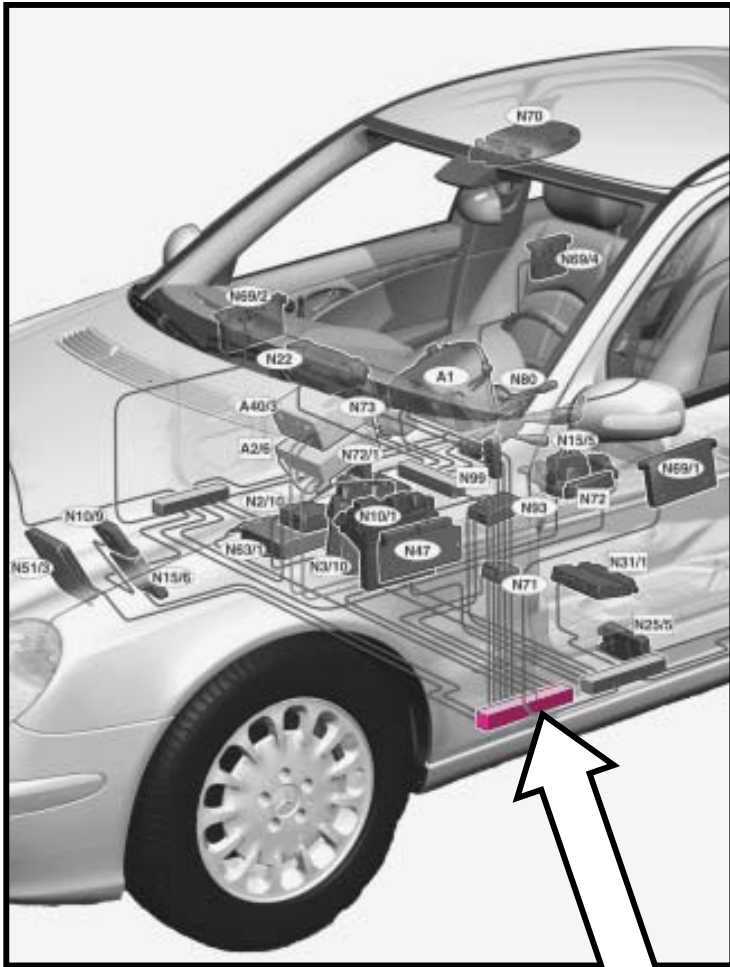

Location: Drivers rocker panel wiring trough

# CAN B Connector (X30/4)

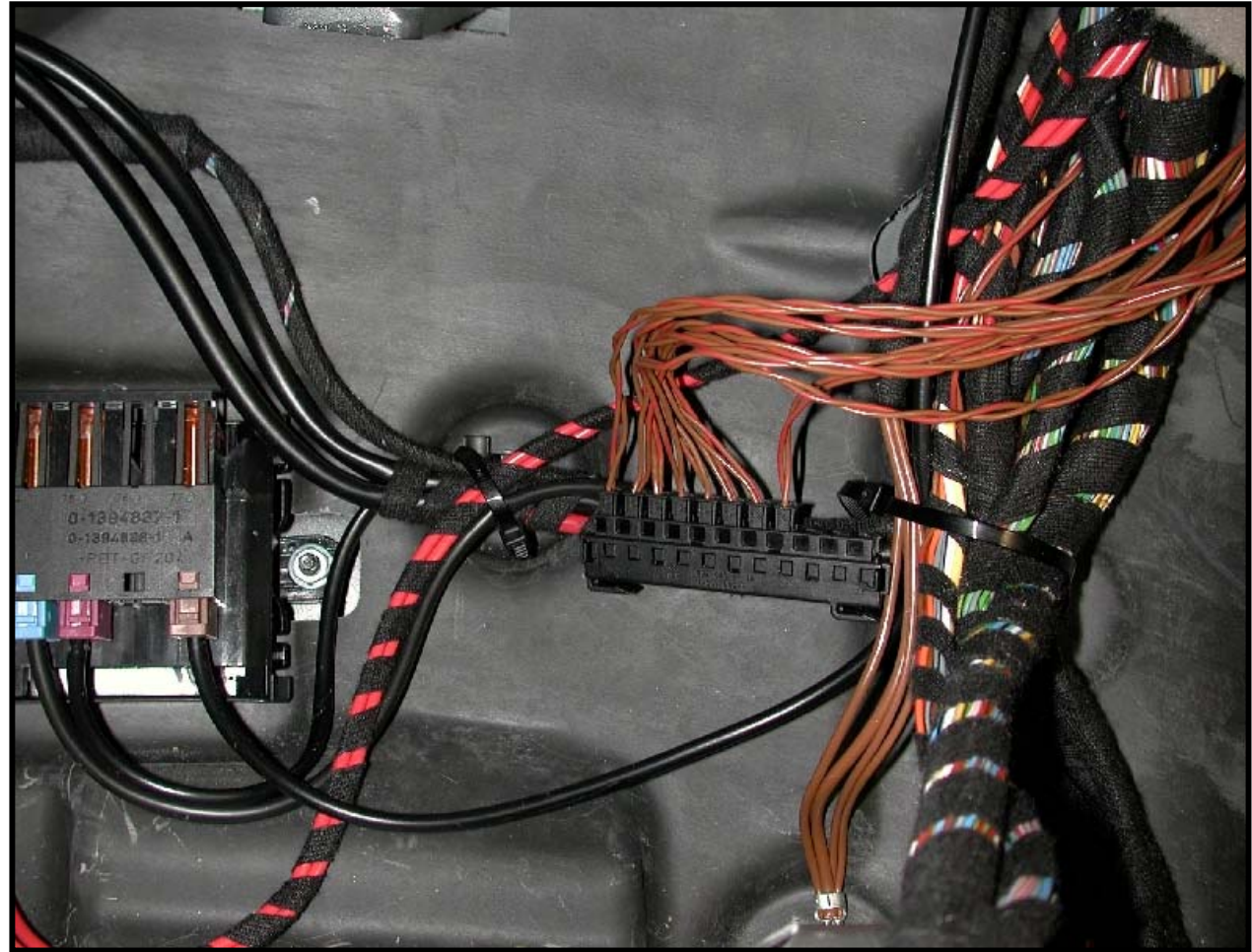
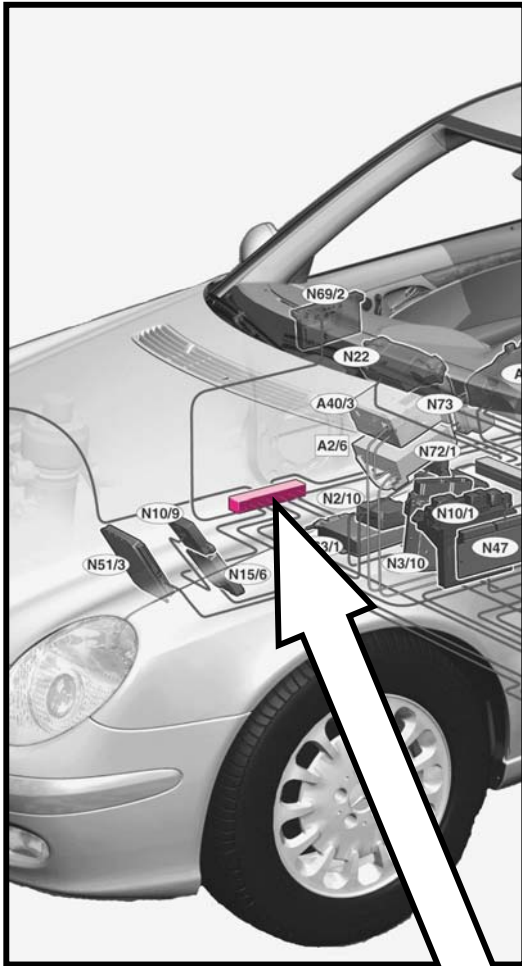

Location: Right side passenger footwell

# CAN B Connector (X30/6)

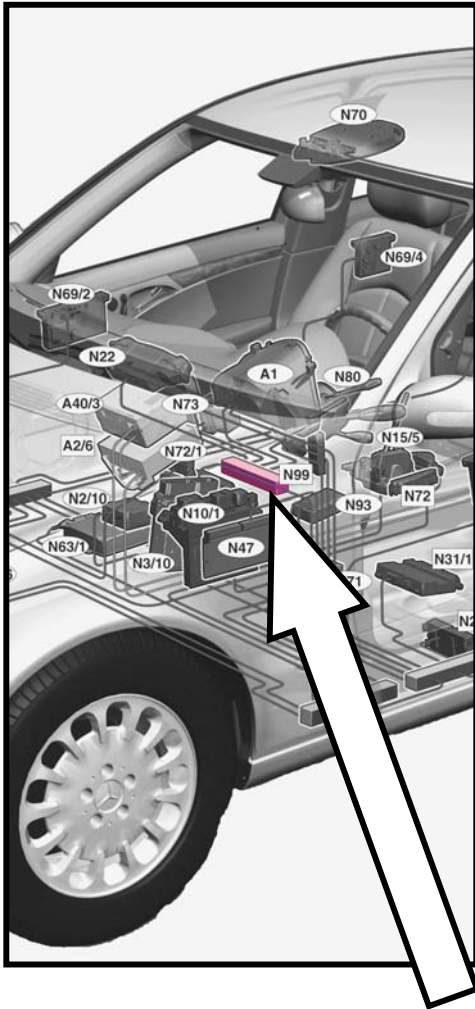

Location: Passenger side HVAC case

# CAN B Connector (X30/7)

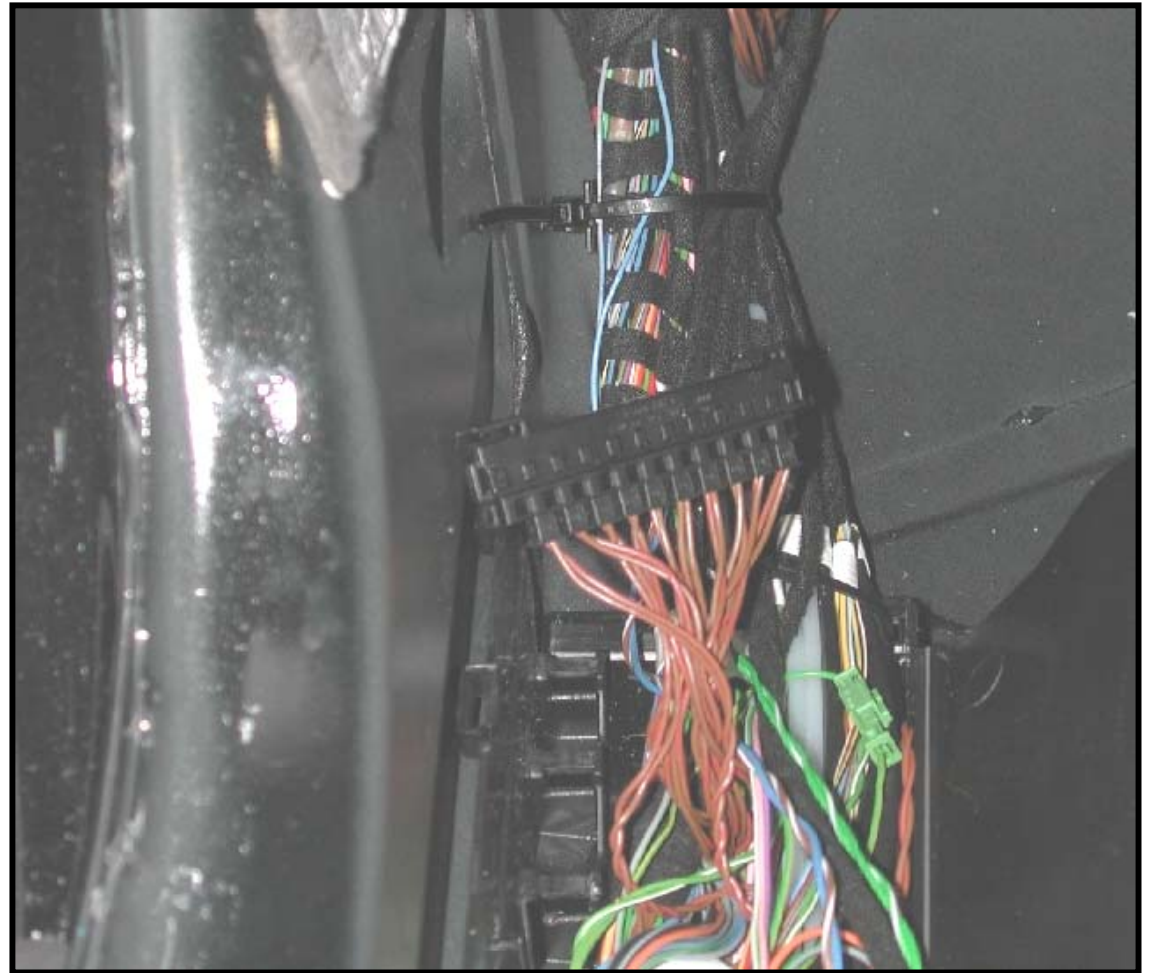
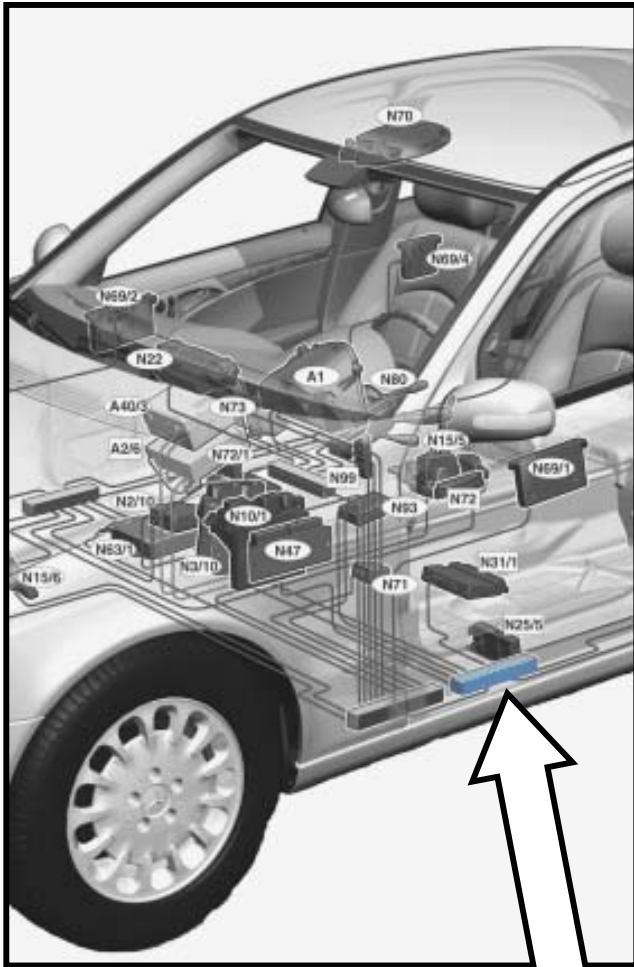

Location: Drivers rocker panel wiring trough

# SAM-Rear (N10/2)

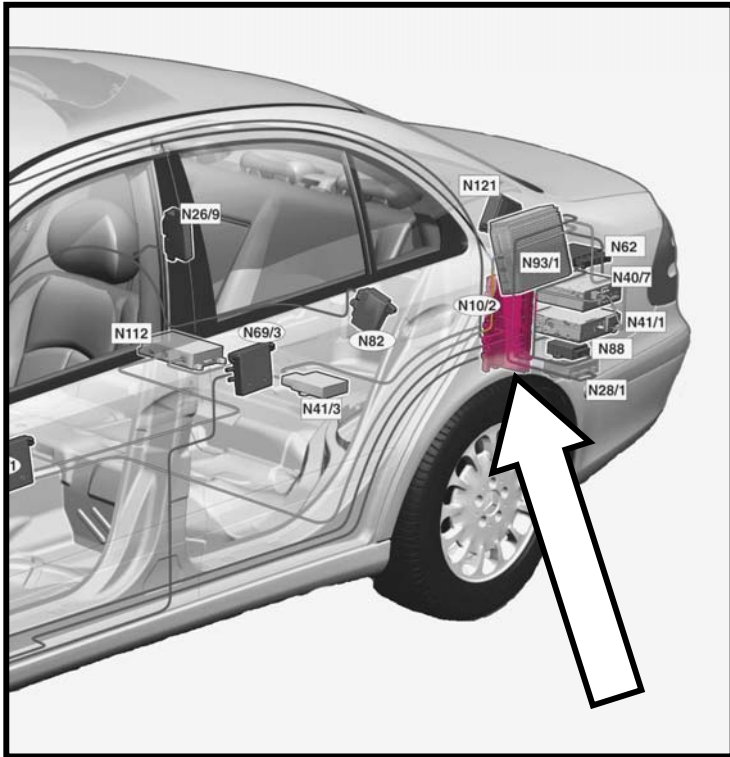

Several control modules are connected to the CAN B network via N10/2.

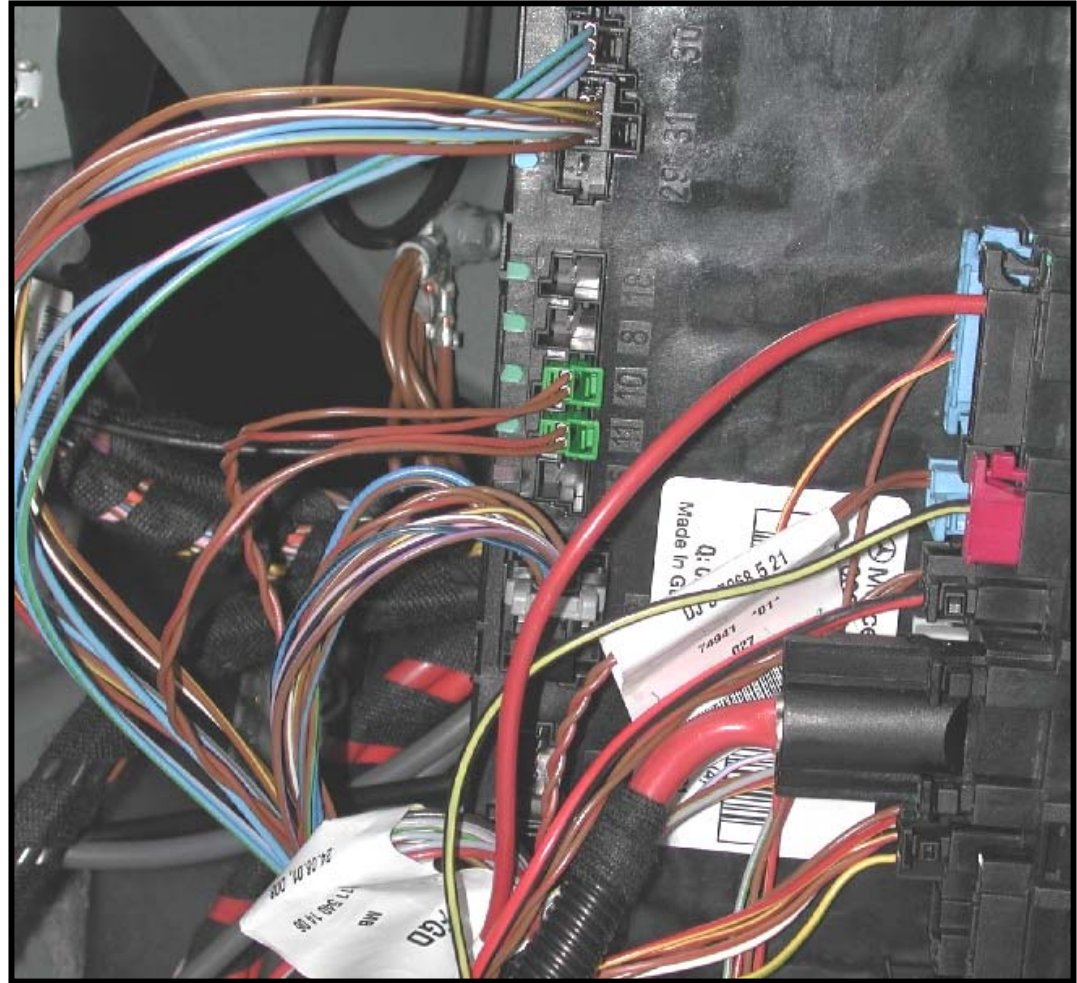

Location: Left side trunk

# W211 CAN D

- Is the diagnostic link between Central Gateway Module (N93), Communications Platform (N112) and SDS / DAS
- CAN D voltage
  - High = 2.5v
  - Low = 2.5v
- CAN D voltage awake
  - High = activity to 3.5v
  - Low = activity to 1.5v
- All modules on CAN B are diagnosed by SDS / DAS through CAN D

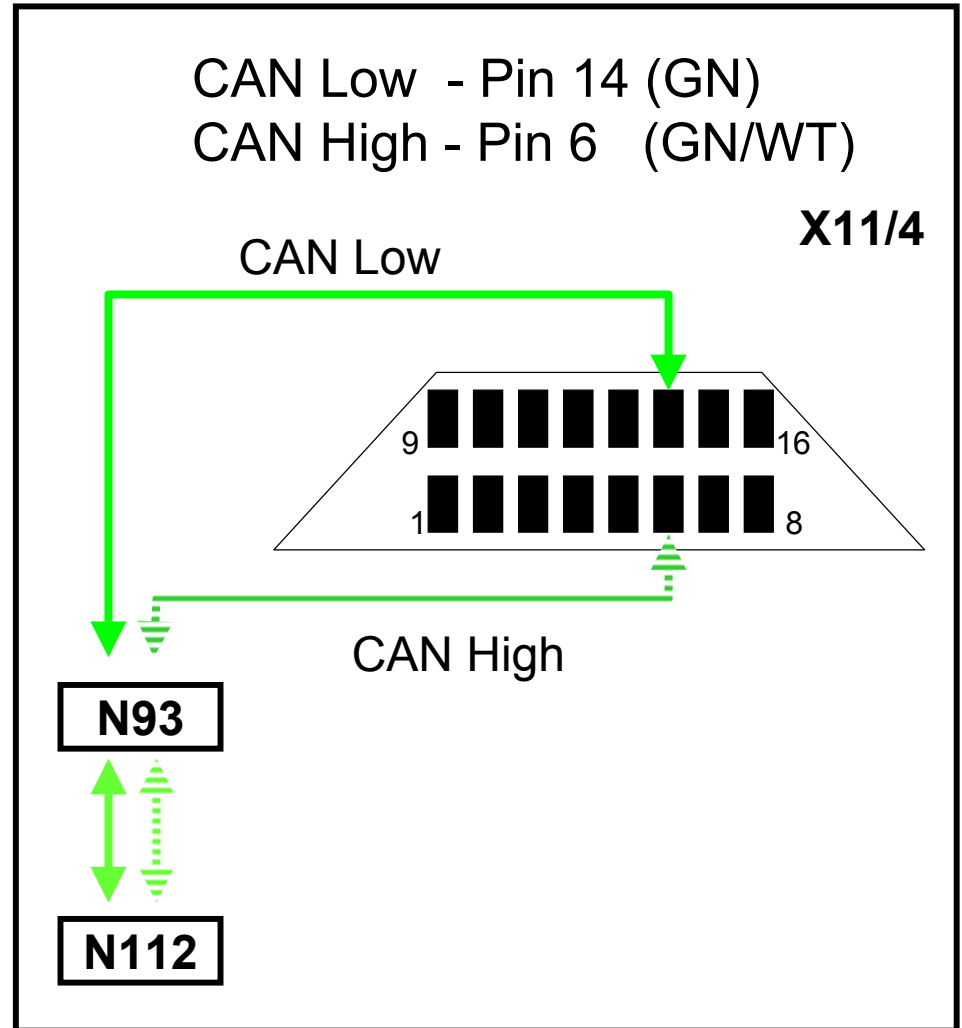

# Audio / Communication Network

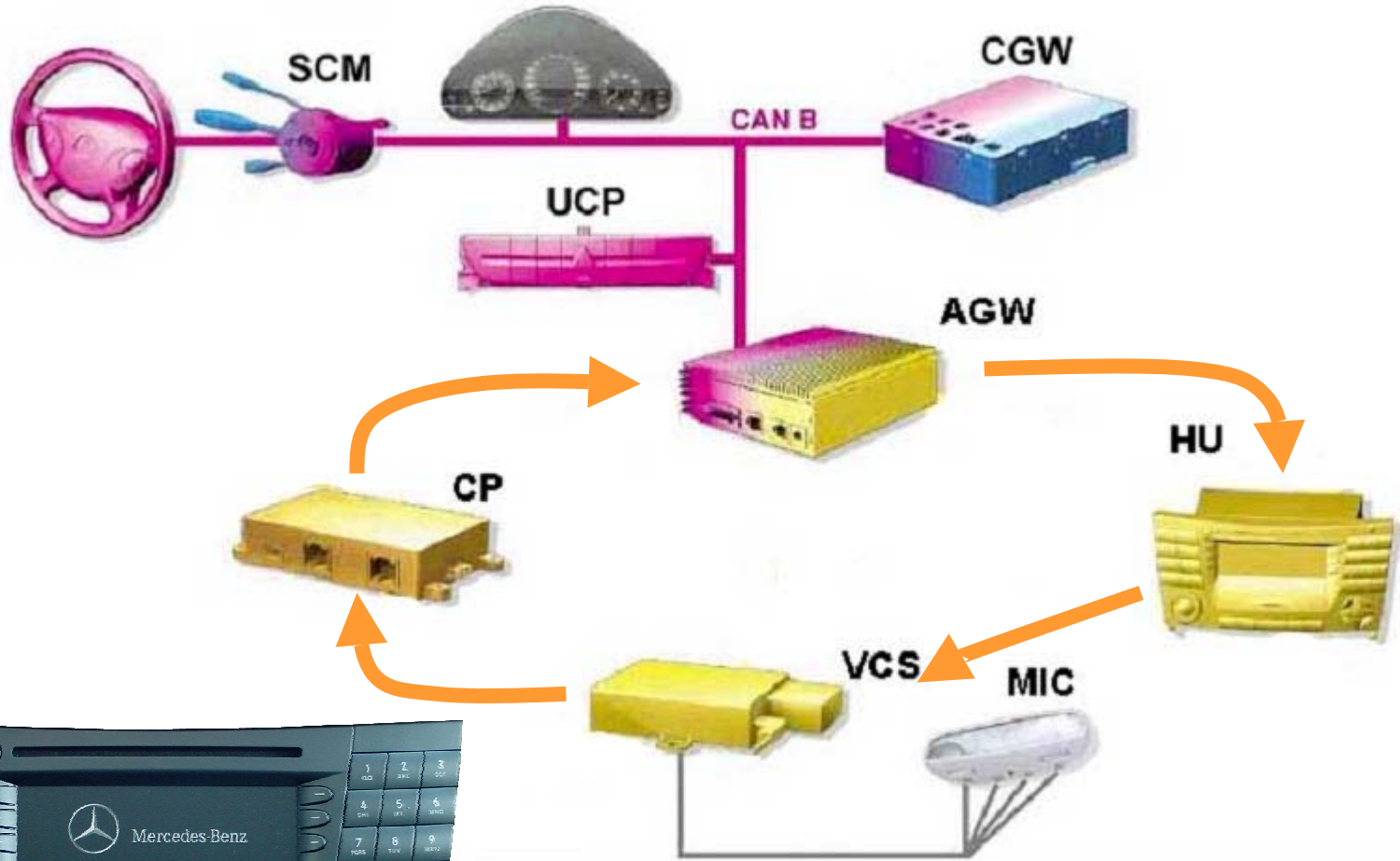

# What is MOST?

- The MOST acronym is derived from its definition as a “Media Oriented System Transport”
- Fiber optics manufactured with greater durability than D2B
- Communication standard created by DCAG, Becker, and other corporations
- The configuration of the system is a combination of ring and star topology similar to D2B



# MOST Component Functions

- AGW, audio gateway (N93/1) *Harman-Becker*:
  - MOST master
  - Tuner
  - Amplifier
  - CAN B to MOST gateway
- CP, communication platform (N112) *Motorola*:
  - HSE
  - TeleAid
  - GPS (location of car for TeleAid)
- VR, voice recognition (A35/11) *Temic/Motorola*  
or  
MIC CM, Microphone in mirror module (A35/1) *AKG*
- CDC compact disc changer (A2/6) *Alpine*
- HU head unit (A2/56) or later COMAND *Harman-Becker*

# MOST Ring Network

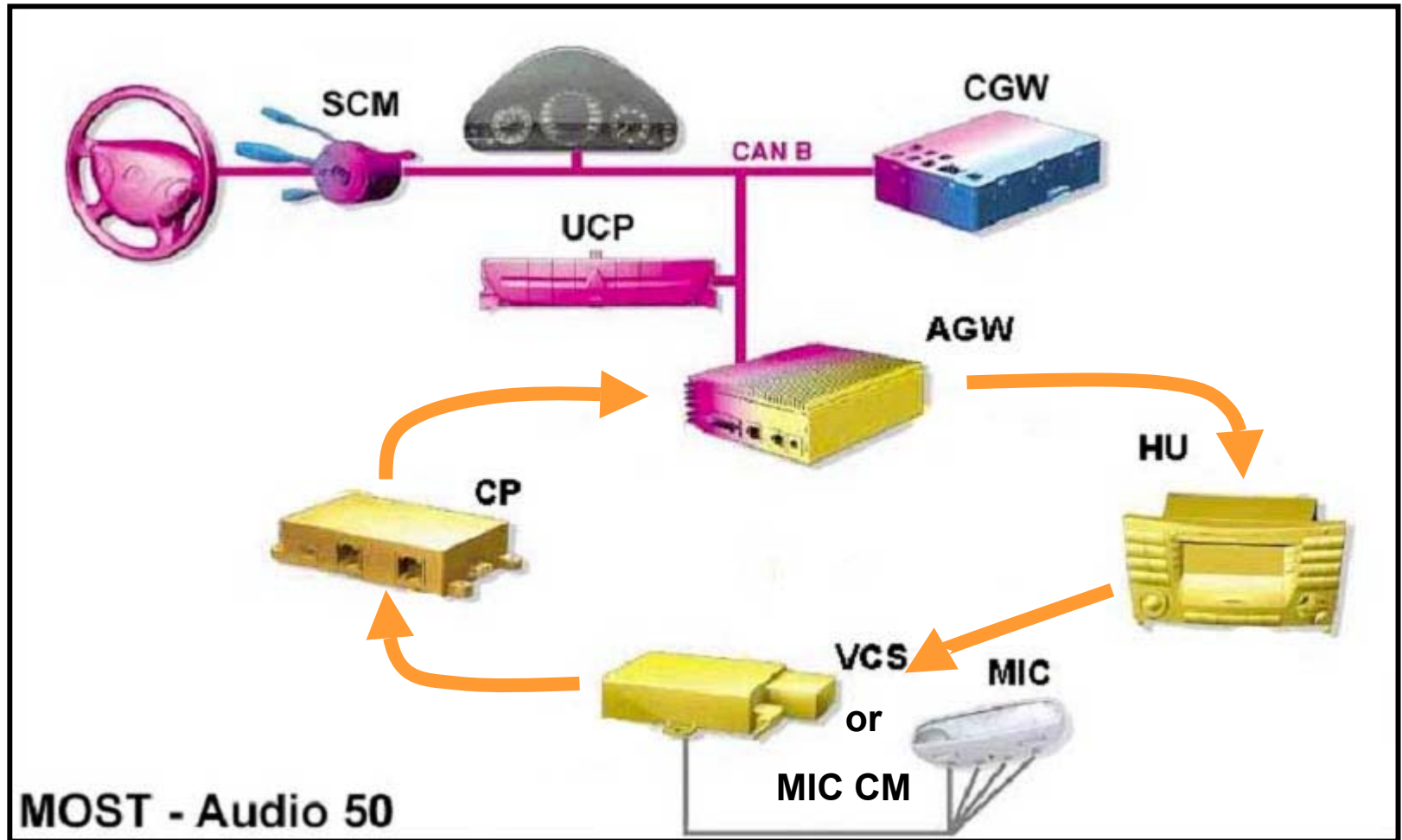

# MOST Bus Legend

## **MOST**

- A2/56 - Audio 50 head unit (HU)
- A35/1 - Microphone module (MIC CM)
- A35/11 - Voice recognition module (VR)
- B25 - Microphones in mirror (MIC)
- N93/1 - Audio gateway module (AGW)
- N112 - Communication platform (CP)

## **CAN B**

- A1 - Instrument cluster (ICM)
- N72/1 - Upper control panel (UCP)
- N80 - Steering column module (SCM)
- N93 - Central gateway module (CGW)

# MOST Wake-Up

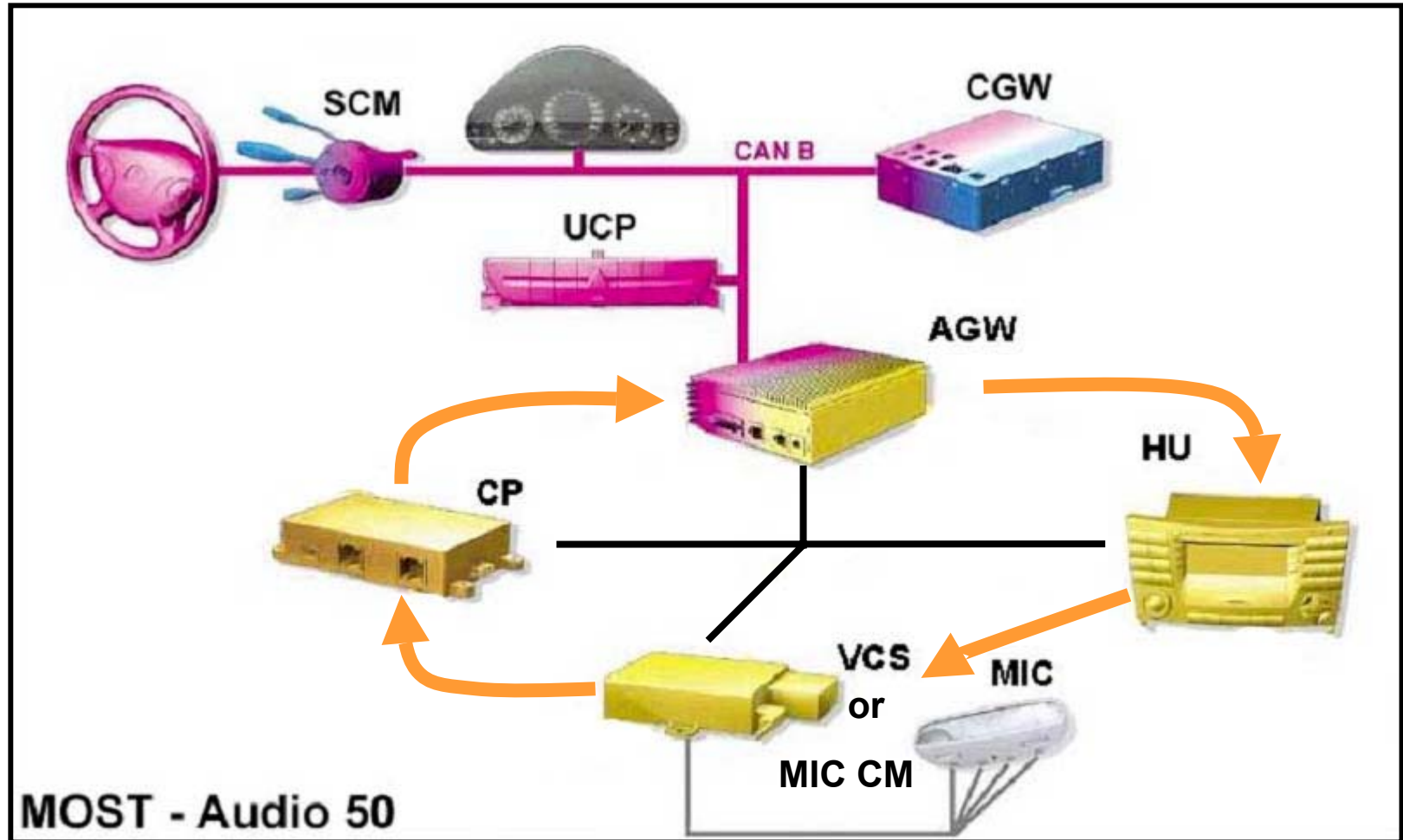

- 12 volt electrical wakeup
- Components will still wake up using optical ring

# MOST Wake-Up Bus Connector



Location: Drivers rocker panel wiring trough

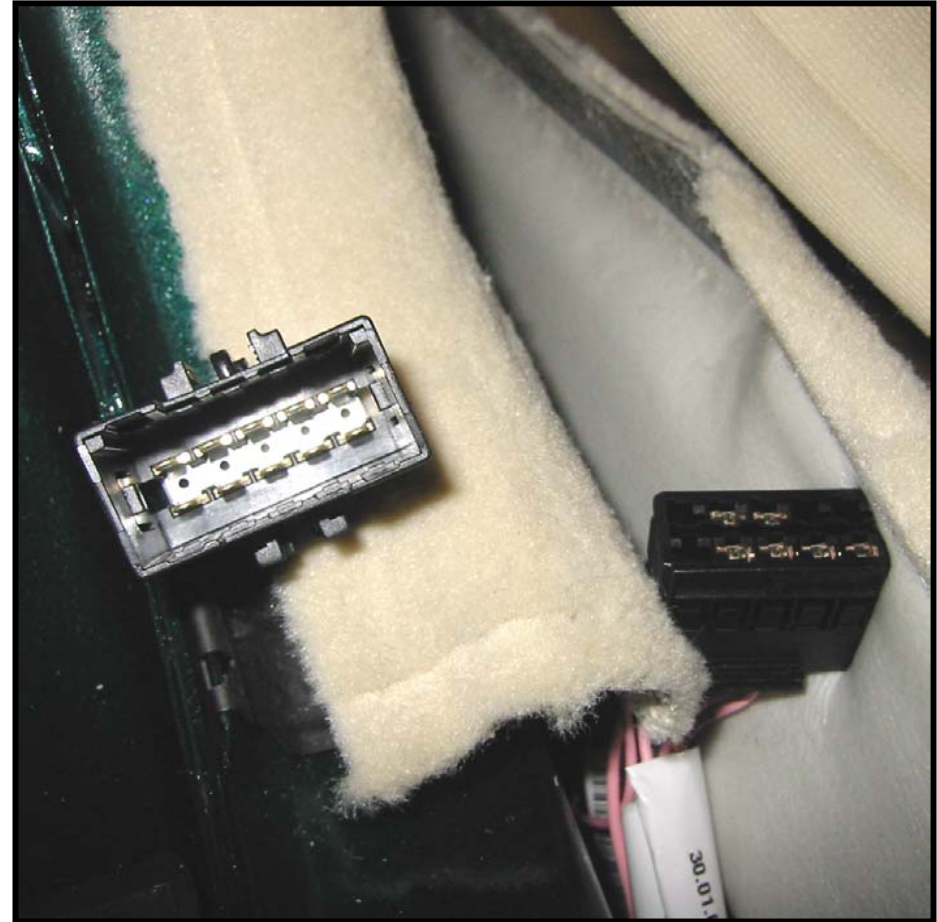

Connector cover incorporates bridges connecting all the individual wake-up wires

# MOST vs. D2B Connector

**D2B**

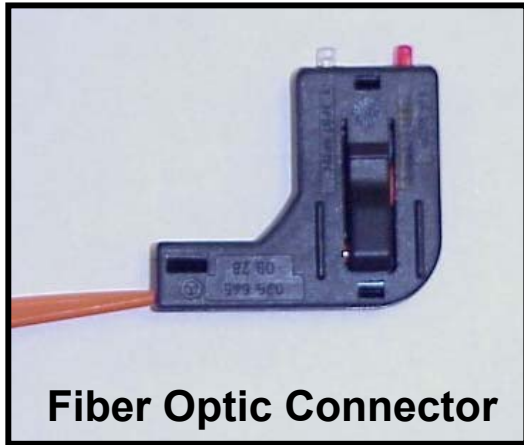

**MOST**

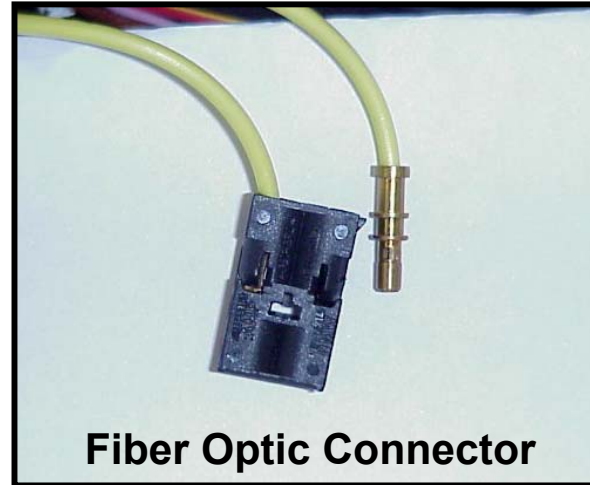

Note: MOST fiber optic ends same color



# MOST - In Car Connections



Location: Left rear door sill

# Audio Gateway Module (N93/1)

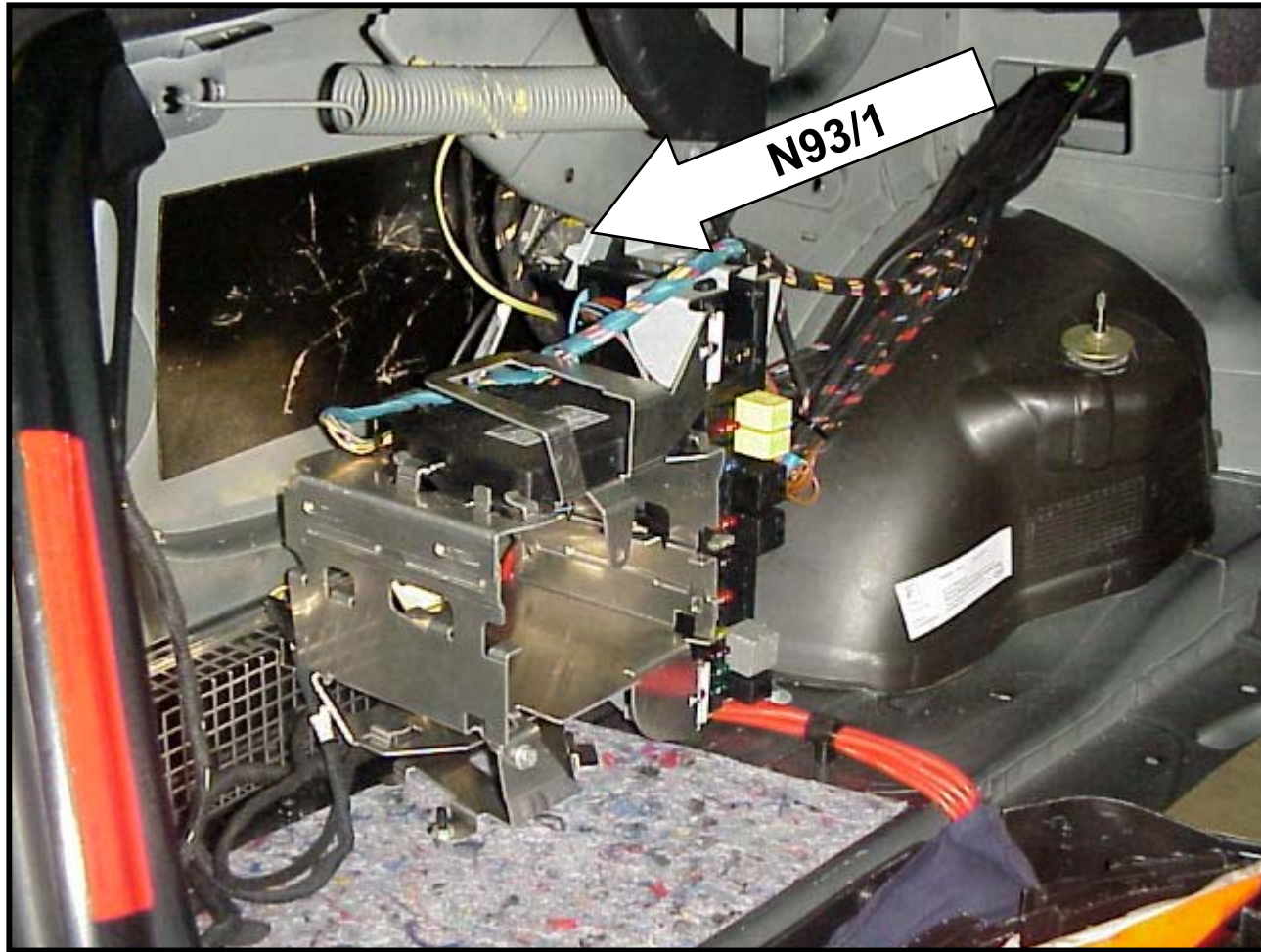

Location: Left side trunk - "buried"



# Audio Gateway Module (N93/1)

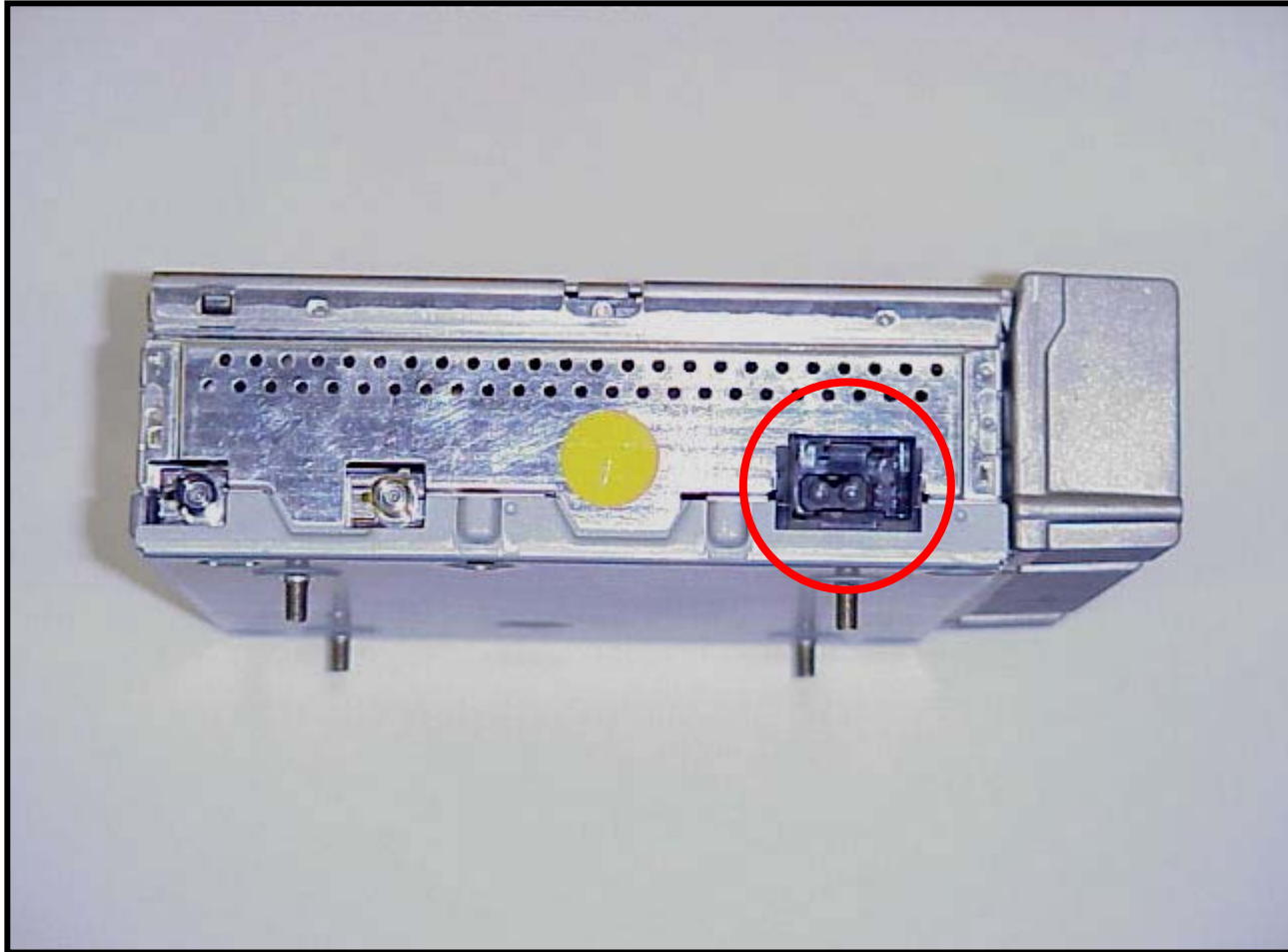

All MOST components have a watchdog circuit, can default to a repeater.

# VR and CP Component Location

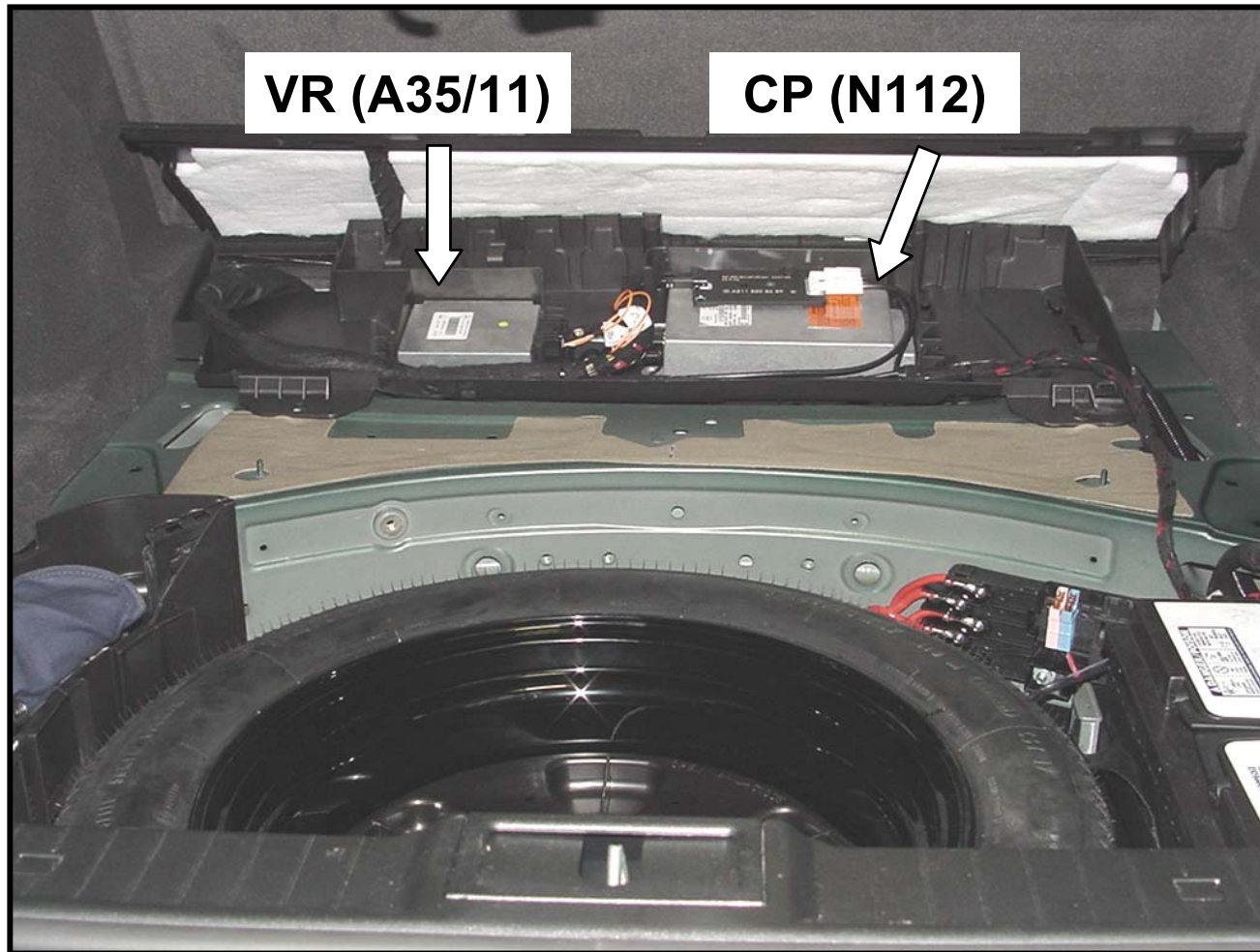

# Communication Platform (N112)

Integrates the following systems:

- HSE
- TeleAid
- GPS (location of car for TeleAid)



# MIC CM (A35/1) / VR (A35/11)

- Microphone in mirror control module (A35/1)
  - installed with basic equipment
  - TeleAid only
  - Manufactured by *AKG*
  
- Voice recognition module (A35/11) (optional)
  - control of audio voice commands
  - Manufactured by *Temic / Motorola*

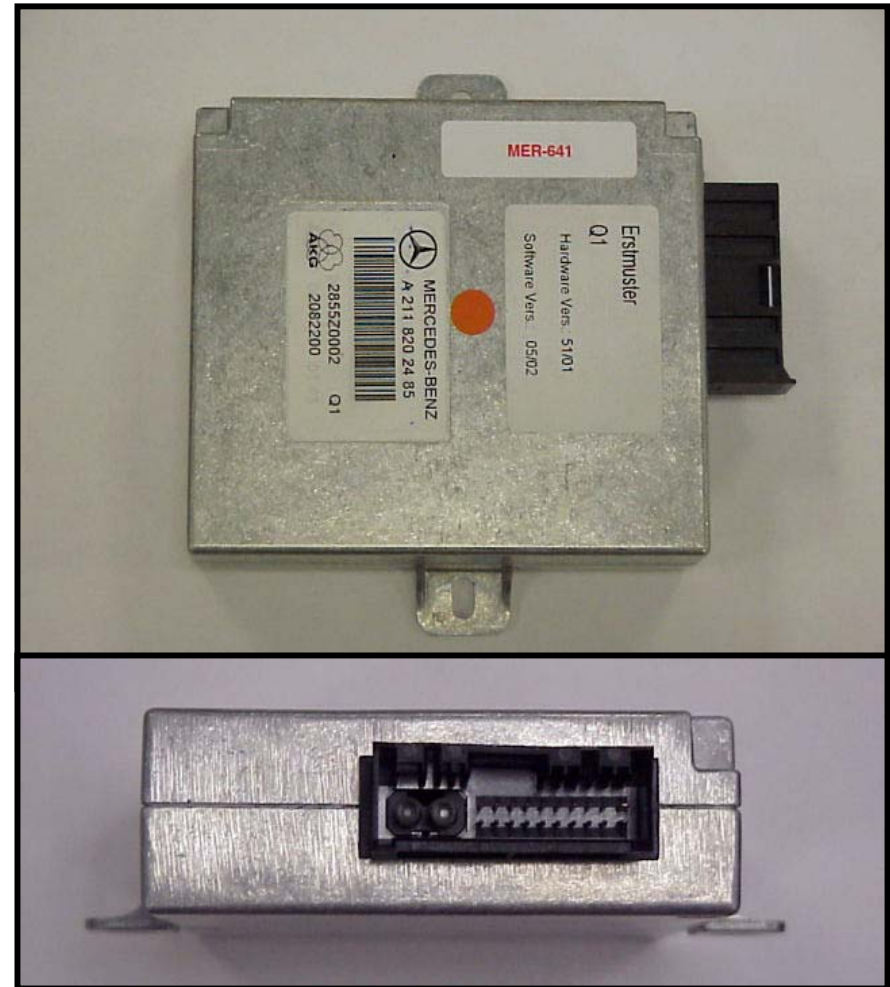

Note: Both control modules have same physical appearance

# Head Unit Audio 50 (A2/56)



# CD Changer (A2/6)



- Controlled by HU or multifunction steering wheel
- Single slot disc loading - no magazine (1)
- Six numbered buttons eject each disc (2)
- Only plays music CD's - No Mini Disc, DVD or Navi function

# D2B vs. MOST Comparison

## D2B

- Speed up to 5.65Mbps
- Maximum of 6 devices
- Orange fiber cable
- Light wavelength = 650 nm (red)
- Max. bend radius of fiber is 25 mm
- 12 volt electrical wake-up
- Created specifically for DCAG \$\$\$
- Limited fiber optic length
  - 10m w / no inline connectors
  - 3m w / 3 inline connectors

## MOST

- Speed up to 24.8Mbps (future up to 50 Mbps)
- Maximum of 64 devices
- Yellow / orange fiber cable
- Light wavelength = 650 nm (red)
- Not critical, but do not kink
- 12 volt electrical and optical wake-up
- Shared communication standard
- Limited fiber optic lengths
  - up to 100m w / unlimited inline connectors
- CP replaces HSE, TeleAid
- Head Unit does not contain radio receiver or amplifier (no radio codes).
- Special MOST connectors