

Parts Information

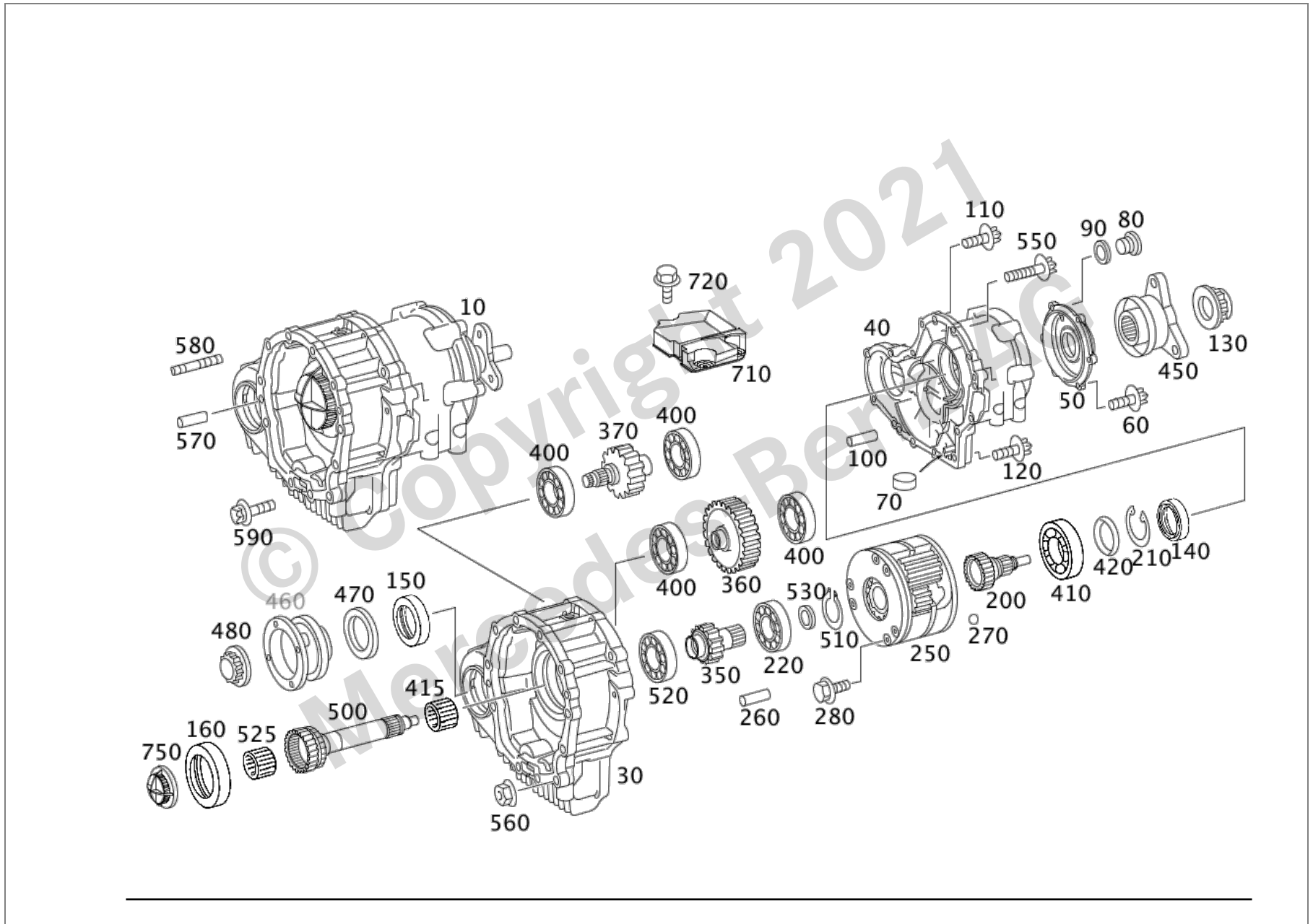







- Parts list -

Vehicle	WDB2110841X199223 (65H)	E 280 CDI 4MATIC	
Color	775 - iridiumsilber metallic	Equipment	131 - Leder Twin anthrazit
Assortment class	PC	Group	28 TRANSFER CASE
Sub-group	010 TRANSFER CASE ASSEMBLY		



















Parts Information







Image ID: drawing_B28010000021

Item	Part number	Designation/additional information	Qty
10	A 211 280 04 00  	TRANSFER CASE 4MATIC FRONT AXLE DRIVE  Code: M005+(M642/M273); Replaced by: A 211 280 05 00 Replaced by: A 211 280 08 00 Replaced by: A 211 280 10 00	1
10	A 211 280 05 00  	LONG. TRANSFER CASE 4MATIC FRONT AXLE DRIVE  Code: M005+(M642/M273); Replaced by: A 211 280 08 00 Replaced by: A 211 280 10 00 Replaces: A 211 280 04 00	1
10	A 211 280 08 00  	TRANSFER CASE 4MATIC FRONT AXLE DRIVE  Code: M005+(M642/M273); Replaced by: A 211 280 10 00 Replaces: A 211 280 05 00 Replaces: A 211 280 04 00	1















Parts Information

Item	Part number	Designation/additional information	Qty
10	A 211 280 10 00  	TRANSFER CASE 4MATIC FRONT AXLE DRIVE  [697] PART IS ONLY OR ALSO SUPPLIED AS RECONDITIONED PART  Code: M005+(M642/M273); Replaces: A 211 280 08 00 Replaces: A 211 280 05 00 Replaces: A 211 280 04 00	1
30	A 220 281 00 01 	* TRANSFER CASE TRANSFER CASE,FRONT  [417] IS NO LONGER DELIVERED, ORDER DELIVERY CONTENTS  Code: M005;	1
40	A 220 281 02 01 	* TRANSFER CASE TRANSFER CASE,REAR  [417] IS NO LONGER DELIVERED, ORDER DELIVERY CONTENTS  Code: M005;	1
50	A 220 281 02 15 	* CAP TRANSFER CASE,REAR  Code: M005;	1
60	N 000000 001141 	* HEXALOBULAR BOLT COVER TO TRANSFER CASE HOUSING; M8X34  Code: M005;	6
70	A 210 276 00 98 	* MAGNET  [402] NO LONGER AVAILABLE  Code: M005;	1

















Parts Information

Item	Part number	Designation/additional information	Qty
80	N 000908 014009 	* SCREW PLUG M14X1.5  Code: M005;	3
90	N 007603 014102 	* SEALING RING SRREW PLUG; 14X18-CU  Code: M005;	3
100	N 000000 004503 	* CYLINDER PIN IN THE HOUSING; M6X26  Code: M005;	2
110	N 000000 000270 	* HEXALOBULAR BOLT CASING FRONT TO CASING REAR  Code: M005;	9
120	N 910105 008012 	* HEXAGON HEAD BOLT CASING FRONT TO CASING REAR; M8X30  Code: M005;	2
130	A 210 990 01 51 	* NUT  Code: M005;	2
140	A 220 997 03 46 	* SEALING RING IN TRANSFER CASE END COVER 46X68X8  Code: M005;	1
150	A 220 997 02 46 	* SEALING RING IN THE HOUSING 40X58X8  Code: M005;	1



















Parts Information

Item	Part number	Designation/additional information	Qty
160	A 220 997 00 46 	* SEALING RING IN THE HOUSING 65X80X8  Code: M005;	1
200	A 220 282 07 01 	* DRIVE SHAFT REAR AXLE  [417] IS NO LONGER DELIVERED, ORDER DELIVERY CONTENTS  Code: M005;	1
210	A 441 994 03 35 	* SNAP RING OUTPUT SHAFT  Code: M005;	1
220	A 220 981 05 05 	* TAPERED ROLLER BEARING REAR DRIVE SHAFT  Code: M005;	1
250	A 211 550 00 08  	* MULTIPLATE CLUTCH, MECH.  Code: M005+(M642/M273); Replaced by: A 211 550 01 08 Replaced by: A 211 550 02 08	1
250	A 211 550 01 08  	* MULTIPLATE CLUTCH, MECH. PLANETARY GEAR TRAIN  Code: M005+(M642/M273/M113); Replaced by: A 211 550 02 08 Replaces: A 211 550 00 08	1

















Parts Information

Item	Part number	Designation/additional information	Qty
250	A 211 550 02 08  	* MULTIPLATE CLUTCH, MECH.  [417] IS NO LONGER DELIVERED, ORDER DELIVERY CONTENTS  Code: M005+(M642/M273/M113); Replaces: A 211 550 01 08 Replaces: A 211 550 00 08	1
260	A 210 981 00 86 	** ROLE PLANETARY GEAR TRAIN  [402] NO LONGER AVAILABLE  Code: M005;	162
270	N 005401 303000 	** BALL PLANETARY GEAR TRAIN  Code: M005;	6
280	N 000000 002109 	** HEXALOBULAR BOLT M6X20  Code: M005+(M642/M273/M113);	6
350	A 220 282 05 01 	* DRIVE SHAFT  [417] IS NO LONGER DELIVERED, ORDER DELIVERY CONTENTS  Code: M005+(M642/M273);	1
360	A 220 282 02 11 	* GEARWHEEL INTERMEDIATE GEAR  [417] IS NO LONGER DELIVERED, ORDER DELIVERY CONTENTS  Code: M005;	1











Parts Information

Item	Part number	Designation/additional information	Qty
370	A 220 282 00 11 	* GEAR OUTPUT SHAFT  [417] IS NO LONGER DELIVERED, ORDER DELIVERY CONTENTS  Code: M005;	1
400	A 220 981 07 05 	* TAPERED ROLLER BEARING INTERMEDIATE GEAR  Code: M005;	2
400	A 220 981 08 05 	* TAPERED ROLLER BEARING OUTPUT SHAFT  Code: M005;	2
410	A 220 981 01 25 	* DEEP-GROOVE BALL BEARING OUTPUT SHAFT  Code: M005;	1
415	A 220 981 16 10 	* NEEDLE BEARING OUTPUT SHAFT,FRONT D 20 MM  Code: M005;	1
415	A 220 981 17 10 	* NEEDLE BEARING OUTPUT SHAFT,REAR D 14 MM  Code: M005;	1
420	A 021 997 17 48 	* SEALING RING COUPLING FLANGE  Code: M005;	1
450	A 220 280 00 44  	* COUPLING FLANGE  Code: M005+(M113/M642/M273/M272);	1

Parts Information

Item	Part number	Designation/additional information	Qty
470	A 210 282 00 76 	** WINDOW DRIVE  Code: M005;	1
480	A 210 990 01 51 	* NUT  Code: M005;	2
500	A 211 282 03 01 	* DRIVE SHAFT  [417] IS NO LONGER DELIVERED, ORDER DELIVERY CONTENTS  Code: M005;	1
510	N 000471 030002 	* RETAINING RING 30X1.5X7  Code: M005;	2
520	A 220 981 06 05 	* TAPERED ROLLER BEARING FRONT DRIVE SHAFT  Code: M005;	1
525	A 220 981 15 10 	* NEEDLE BEARING  Code: M005;	1
530	A 203 282 00 62 	* PRESSURE DISK  Code: M005;	1
550	N 910143 008014 	* HEXALOBULAR BOLT CASING FRONT TO CASING REAR; M8X120  Code: M005;	4

Parts Information

Item	Part number	Designation/additional information	Qty
560	N 913023 008003 	* NUT CASING FRONT TO CASING REAR; M8  Code: M005; Replaced by: N 000000 003175	4
560	N 000000 003175 	* NUT CASING FRONT TO CASING REAR; M8  Code: M005; Replaces: N 913023 008003	4
570	N 000007 008108	CYLINDER PIN 6X12  Code: M005;	2
580	N 000835 008086	SCREW M8X25  Code: M005; Replaced by: N 000000 004431	4
580	N 000000 004431	SCREW  Code: M005; Replaces: N 000835 008086	4
590	N 910143 008003	HEXALOBULAR BOLT M8X30  Code: M005;	3
710	A 211 281 04 47	VIBRATION DAMPER  [402] NO LONGER AVAILABLE  Code: M642+M005;	1

Parts Information

Item	Part number	Designation/additional information	Qty
720	N 000000 000276 	HEXALOBULAR BOLT MOUNTING VIBRATION ABSORBER; M8X20  Code: M005+(M272/M642);	3
750	A 220 281 01 82 	* CAP FRONT DRIVE SHAFT  Code: M005; Replaced by: A 220 281 04 82	1
750	A 220 281 04 82 	* PROTECTIVE CAP FRONT DRIVE SHAFT  Code: M005; Replaces: A 220 281 01 82	1