

- Parts list -

Vehicle	WDBUF76J05A637043 (64U)	E 55 AMG KOMPRESSOR	
Color	040 - SCHWARZ - UNILACK	Equipment	251 - Leder anthrazit/anthrazit
FIN: WDB2110761A637043		Assortment class	PC
Group	61 SUBSTRUCTURE	Sub-group	015 FRONT FLOOR

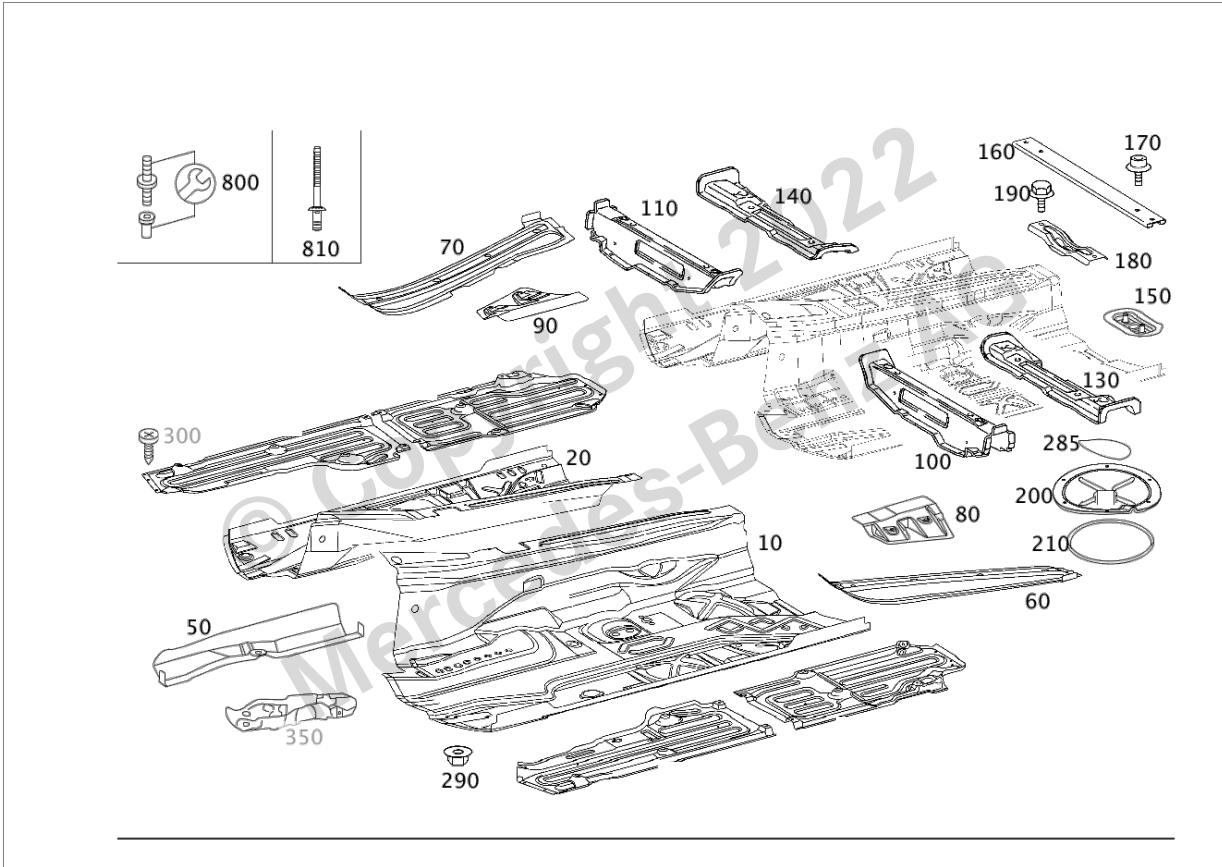





















Image ID: drawing_B61015000115

Item	Part number	Designation/additional information	Qty
10	A 211 610 09 60	FLOOR LEFT Code: 802/803/804/804/805/806;	1
20	A 211 610 10 60 	FLOOR RIGHT Code: 802/803/804/804/805/806;	1
50	A 211 616 21 16	REINFORCEMENT AT TUNNEL	1
60	A 211 611 01 22	LONGITUDINAL MEMBER FRONT LEFT	1
70	A 211 611 02 22	LONGITUDINAL MEMBER FRONT RIGHT  [402] NO LONGER AVAILABLE	1
80	A 211 616 07 16	REINFORCEMENT MAIN FLOOR,FRONT LEFT	1
90	A 211 616 08 16	REINFORCEMENT MAIN FLOOR,FRONT RIGHT	1

Parts Information

Item	Part number	Designation/additional information	Qty
100	A 211 610 17 20	CROSSMEMBER BELOW FRONT SEAT,FRONT LEFT  [402] NO LONGER AVAILABLE	1
110	A 211 610 18 20 	CROSSMEMBER BELOW FRONT SEAT,FRONT RIGHT  [429] THEFT-RELEVANT PART	1
130	A 211 610 31 20	CROSSMEMBER, DRIVER SEAT BELOW FRONT SEAT,REAR LEFT Replaced by: A 211 610 33 20	1
130	A 211 610 33 20	CROSSMEMBER BELOW FRONT SEAT,REAR LEFT  [402] NO LONGER AVAILABLE Replaces: A 211 610 31 20	1
140	A 211 610 20 20	CROSS MEMBER BELOW FRONT SEAT,REAR RIGHT Replaced by: A 211 610 34 20	1
140	A 211 610 34 20	CROSSMEMBER BELOW FRONT SEAT,REAR RIGHT  [402] NO LONGER AVAILABLE Replaces: A 211 610 20 20	1
150	A 211 616 11 31	MOUNTING CONSOLE CROSSMEMBER DRIVER SIDE, REAR	2
160	A 211 619 01 34	STRUT BETWEEN MAIN FLOOR LEFT AND RIGHT	1
170	N 000000 001152	HEXALOBULAR BOLT STRUT TO CONSOLE; M8X16	4
180	A 211 619 00 16	REINFORCEMENT CROSSMEMBER DRIVER SIDE, REAR Replaced by: A 211 619 07 16	1
180	A 211 619 07 16	REINFORCEMENT CROSSMEMBER DRIVER SIDE, REAR Replaces: A 211 619 00 16	1
190	N 000000 003853	HEXALOBULAR BOLT REINFORCEMENT TO CROSS MEMBER; M8X16	2
200	A 211 619 25 38	COVER  Code: M113+M55/M156+M63/M272+M012;	1
210	A 001 987 70 46	SEALING PROFILE AT COVERING  [404] ORDER BY THE METER  Code: M113+M55/M156+M63;	NB
250	A 211 619 01 38	COVER BELOW MAIN FLOOR, FRONT LEFT Replaced by: A 211 619 19 38 Replaced by: A 219 680 19 06	1
250	A 211 619 19 38	COVER BELOW MAIN FLOOR, FRONT LEFT  Code: -M156; Replaced by: A 219 680 19 06 Replaces: A 211 619 01 38	1
250	A 219 680 19 06	TRIM BELOW MAIN FLOOR, FRONT LEFT  Code: -M156; Replaces: A 211 619 19 38 Replaces: A 211 619 01 38	1

Parts Information

Item	Part number	Designation/additional information	Qty
260	A 211 619 02 38	COVER BELOW MAIN FLOOR, FRONT RIGHT Replaced by: A 219 680 20 06	1
260	A 219 680 20 06	TRIM BELOW MAIN FLOOR, FRONT RIGHT Replaces: A 211 619 02 38	1
270	A 211 619 03 38	COVER BELOW MAIN FLOOR, REAR LEFT Replaced by: A 211 619 21 38 Replaced by: A 219 680 21 06	1
270	A 211 619 21 38	COVER BELOW MAIN FLOOR, REAR LEFT Replaced by: A 219 680 21 06 Replaces: A 211 619 03 38	1
270	A 219 680 21 06	TRIM BELOW MAIN FLOOR, REAR LEFT  [409] TO BE ADAPTED DURING ASSEMBLY Replaces: A 211 619 21 38 Replaces: A 211 619 03 38	1
280	A 211 619 04 38 	COVER BELOW MAIN FLOOR, REAR RIGHT Replaced by: A 211 619 22 38 Replaced by: A 219 680 22 06	1
280	A 211 619 22 38 	COVER BELOW MAIN FLOOR, REAR RIGHT Replaced by: A 219 680 22 06 Replaces: A 211 619 04 38	1
280	A 219 680 22 06 	TRIM BELOW MAIN FLOOR, REAR RIGHT Replaces: A 211 619 22 38 Replaces: A 211 619 04 38	1
285	A 211 682 13 10 	* DAMPING SOUNDPROOFING  [402] NO LONGER AVAILABLE  Code: M113+M55/M156+M63;	1
290	A 201 990 00 50	PLASTIC NUT COVER TO MAIN FLOOR LEFT	4
290	A 201 990 00 50	PLASTIC NUT COVER TO LONGITUDINAL MEMBER, BOTTOM LEFT	1
290	A 201 990 00 50	PLASTIC NUT COVER TO LONGITUDINAL MEMBER, OUTSIDE LEFT	1
290	A 201 990 00 50	PLASTIC NUT COVER TO MAIN FLOOR RIGHT	4
290	A 201 990 00 50	PLASTIC NUT COVER TO LONGITUDINAL MEMBER, BOTTOM RIGHT	1
290	A 201 990 00 50	PLASTIC NUT COVER TO LONGITUDINAL MEMBER, OUTSIDE RIGHT	1
290	A 201 990 00 50	PLASTIC NUT COVER TO CROSSMEMBER UNDER DRIVER SEAT, LEFT	1
290	A 201 990 00 50	PLASTIC NUT COVERING TO SIDE MEMBER REAR LEFT	1
290	A 201 990 00 50	PLASTIC NUT COVER TO TANK BAND, LEFT	1
290	A 201 990 00 50	PLASTIC NUT COVERING TO FLOOR	2

Parts Information

Item	Part number	Designation/additional information	Qty
290	A 201 990 00 50	PLASTIC NUT COVER TO CROSSMEMBER BELOW DRIVER SEAT, RIGHT	1
290	A 201 990 00 50	PLASTIC NUT COVERING TO SIDE MEMBER REAR RIGHT	1
290	A 201 990 00 50	PLASTIC NUT COVER TO TANK BAND, RIGHT	1
800	A 000 990 12 10	PARTS KIT, THREADED PIN REPAIR SOLUTION FOR RUPTURED WELDED PINS	NB
810	A 000 991 76 32	BLIND RIVET REPAIR SOLUTION; 6,4 X 12MM / 1-3,5MM  [002970, 402] RIVET ONLY VALID FOR BR 222. FOR REPAIR INFORMATION, SEE WIS.	NB