

- Parts list -

Vehicle	WDB2112871B441798 (65J)	E 350 4MATIC	
Color	040 - SCHWARZ - UNILACK	Equipment	141 - MB-TEX / LEDER TWIN/ARTICO - SCHWARZ / ANTHRAZIT
VIN: WDBUH87X09B441798		Assortment class	PC
Group	33 FRONT AXLE	Sub-group	090 4MATIC FRONT AXLE SHAFT

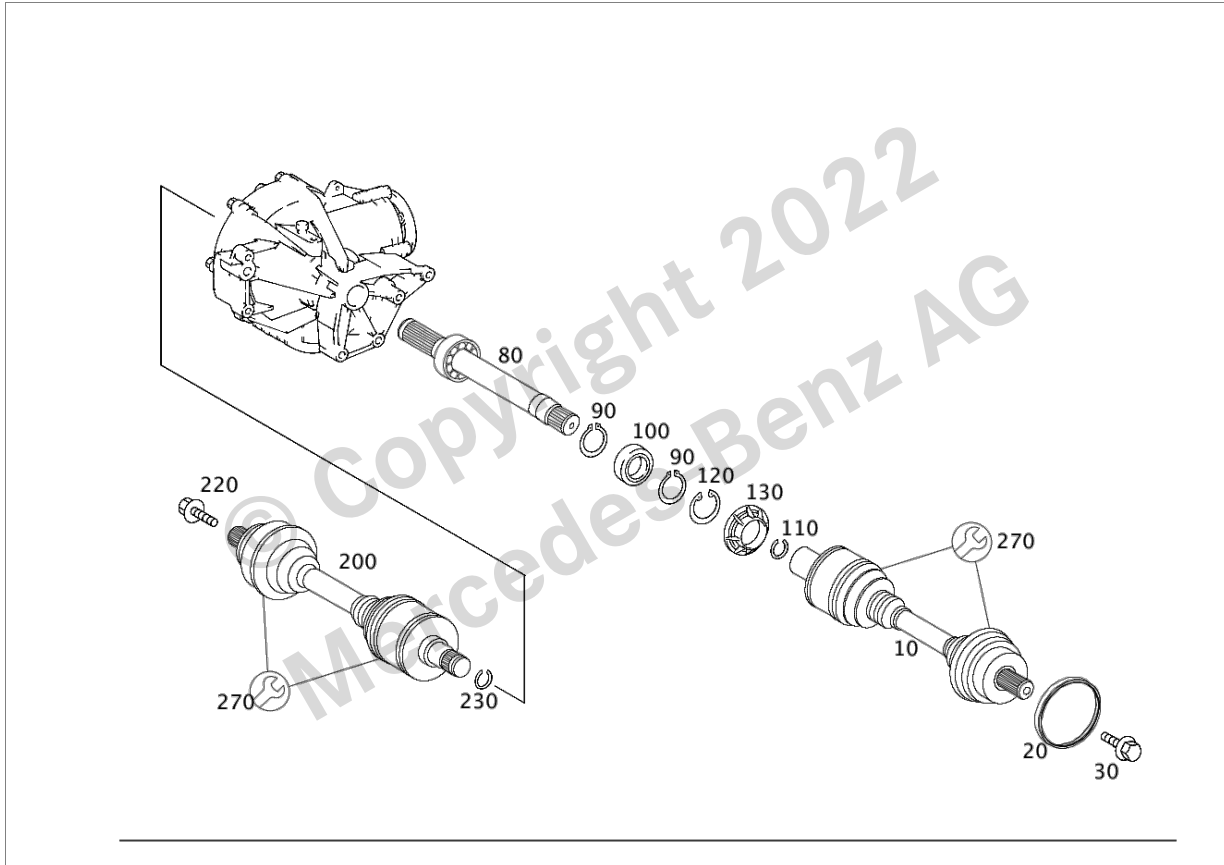

























Image ID: drawing_B33090000017

Item	Part number	Designation/additional information	Qty
10	A 211 330 11 01 	DRIVE SHAFT LEFT Code: M005; Replaced by: A 211 330 17 01	1
10	A 211 330 17 01 	DRIVE SHAFT LEFT [697] PART IS ONLY OR ALSO SUPPLIED AS RECONDITIONED PART Code: M005; Replaces: A 211 330 11 01	1
20	A 203 357 03 82 	* PULSE RING FRONT LEFT Code: M005;	1
20	A 203 357 03 82 	* PULSE RING FRONT RIGHT Code: M005;	1

Parts Information

Item	Part number	Designation/additional information	Qty
30	A 203 990 00 03	SCREW PROPELLER SHAFT TO FRONT WHEEL HUB, LEFT  Code: M005; Replaced by: A 016 990 13 01	1
30	A 016 990 13 01	COMBI-HEXAGON HEAD BOLT PROPELLER SHAFT TO FRONT WHEEL HUB, LEFT  [] Screw included in set of boots scope of supply  Code: M005; Replaces: A 203 990 00 03	1
80	A 112 030 18 72 	SHAFT INTERMEDIATE SHAFT  Code: M005;	1
90	N 900055 030301 	* RETAINING RING 30X2  Code: M005;	2
100	A 112 980 01 15 	* DEEP-GROOVE BALL BEARING  Code: M005;	1
110	A 112 994 09 35 	* SNAP RING  Code: M005;	1
120	N 000472 055000	RETAINING RING 55X2  Code: M005;	1
130	A 210 334 00 19	PROTECTIVE RING  [402] NO LONGER AVAILABLE  Code: M005;	1
200	A 211 330 12 01	DRIVE SHAFT RIGHT  Code: M005; Replaced by: A 211 330 18 01	1
200	A 211 330 18 01 	DRIVE SHAFT RIGHT  [697] PART IS ONLY OR ALSO SUPPLIED AS RECONDITIONED PART  Code: M005; Replaces: A 211 330 12 01	1
220	A 203 990 00 03	SCREW PROPELLER SHAFT TO FRONT WHEEL HUB, RIGHT  Code: M005; Replaced by: A 016 990 13 01	1
220	A 016 990 13 01	COMBI-HEXAGON HEAD BOLT PROPELLER SHAFT TO FRONT WHEEL HUB, RIGHT  [] Screw included in set of boots scope of supply  Code: M005; Replaces: A 203 990 00 03	1
230	A 112 994 09 35	SNAP RING  Code: M005;	1
270	A 220 330 01 85	REPAIR KIT, BOOT (PARTS KIT) AXLE SHAFT BOOT, EXTERNAL  Code: M005;	2
270	A 211 330 01 85	REPAIR KIT, BOOT (PARTS KIT) INNER AXLE SHAFT BOOT  Code: M005;	2