

*DENSO*

# A/C Components

| 2020

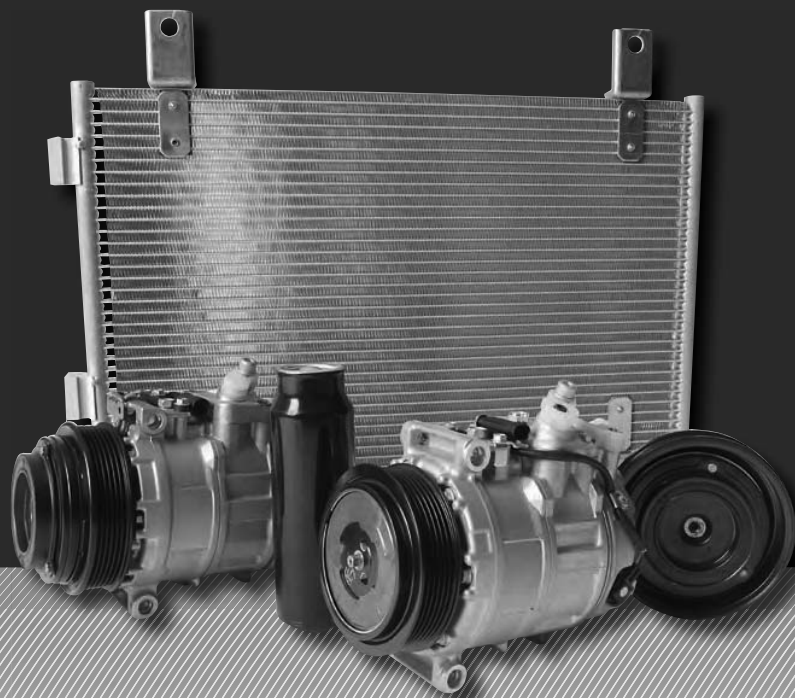

Driven by  
**Quality**

# Catalogue | Overview

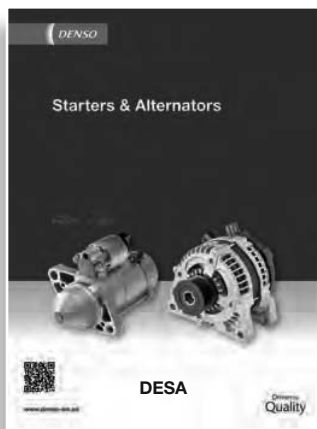

# A/C Components | Table of Contents

## GB

4	Introduction
5	Product Descriptions
7	Installation Instructions
31	Compressors
339	Condensers
635	Receiver Driers
679	Expansion Valves
701	Pressure Switches
717	Limited Warranty
719	Disclaimer

## D

8	Einleitung
9	Produktbeschreibungen
11	Einbauanleitung
31	Kompressoren
339	Kondensatoren
635	Sammelbehälter mit Trocknereinsatz
679	Expansionsventil
701	Druckschalter oder Druckwächter
719	Technische Übersicht

## E

12	Introducción
13	Descripción de los productos
15	Instrucciones de instalación
31	Compresores
339	Condensadores
635	Filtro secador-acumulador
679	Válvula de expansión
701	Presostato
719	Descargo de responsabilidad
720	Garantía limitada

## SE

16	Inledning
17	Produktbeskrivningar
19	Installationsanvisningar
31	Kompressorolja
339	Kondensorer
635	Torkfilter
679	Expansionsventil
701	Tryckkontakt eller tryckgivare
719	Friskrivningsklausul
721	Garantivillkor

## PL

20	Wprowadzenie
21	Opisy produktu
23	Instrukcje instalacji
31	Kompressorer
339	Skraplacze
635	Osuszacz
679	Zawór rozprężny
701	Presostat lub czujnik ciśnienia
722	Ograniczona gwarancja
724	Zrzeczenie się odpowiedzialności

## RU

24	Введение
25	Ассортимент
27	Инструкция по установке
31	Компрессоры
339	Конденсаторы
635	Обновления В Ассортименте
679	Расширительный клапан
701	Переключатель (датчик) давления
723	Ограниченная гарантия
724	Условия Предоставления Информации



## The DENSO difference

Drivers and their passengers expect a comfortable cabin on every journey, in all weathers. Which is why car makers worldwide rely on DENSO – the world’s number one manufacturer of original Thermal products – for efficient, reliable Heating, Ventilation and Air Conditioning Components.

Not only a developer of advanced Air Conditioning and Engine Cooling systems for leading car manufacturers, DENSO is also the world leader in A/C compressors – with a 42% OE market share. This outstanding engineering knowledge is reflected in the quality of our A/C Compressor programme for the aftermarket – providing the international benchmark for technology and quality.

**Offering a 100% OE quality range, DENSO’s A/C Compressors deliver outstanding reliability, extensive car parc coverage and are easily referenced in TecDoc.**

### Air Conditioning System

#### System Layout

The main purpose of an air conditioning system is to maintain the air in the passenger compartment at a comfortable environmental level by cooling or heating the air blown into the passenger compartment. In addition it will reduce humidity, dust and smells in the passenger compartment. To perform these operations, the car’s air conditioning system generally consists of a heater, evaporator and a ventilation system including a blower, air ducts, and air purifier.

The main components of the refrigeration cycle:

- > Compressor driven by the car engine
- > Condenser
- > Receiver / Drier
- > Expansion Valve
- > Evaporator

The system components are connected to each other with different tubes and hoses.

#### Operation of a car air conditioning system

##### DENSO Compressor

The compressor sucks in the low temperature and low pressure gaseous refrigerant from the evaporator, and compresses it into a high temperature and high pressure gas. The refrigerant is then discharged and supplied to the condenser. The engine, via a belt and clutch or pulley, drives the compressor.

##### DENSO Condenser

A condenser is a heat exchanger, which removes the heat of the high temperature and high pressure gaseous refrigerant supplied by the compressor and condenses it into a liquid. When the refrigerant is liquefied it flows to the receiver drier.

##### DENSO Receiver Drier

The receiver drier will store the refrigerant until the evaporator requires it, ensuring that only liquefied refrigerant flows to the evaporator. Secondly the refrigerant is filtered and dried. After separation of gas and liquid, liquid refrigerant flows to the expansion valve.

##### DENSO Expansion Valve

The expansion valve injects the refrigerant into the evaporator, changing the refrigerant from a high pressure and high temperature liquid, into a low pressure and low temperature liquid and gas mixture.

##### DENSO Evaporator

The evaporator vaporises the low pressure and low temperature refrigerant. When vaporising the refrigerant a large amount of heat is required which the evaporator absorbs from the warm air passing over the evaporator fins, thus cooling the passenger compartment. All liquid changes into a gas and flows to the compressor. The process is then repeated again.

##### DENSO Pressure Switch or Sensor

The pressure switch (or pressure sensor) is a safety device which protects the refrigerant cycle components from a too high pressure or a too low pressure. Secondly the pressure sensor sends the signal to a control unit, which uses the signal to calculate the correct variable displacement of the electronic controlled variable type compressor.

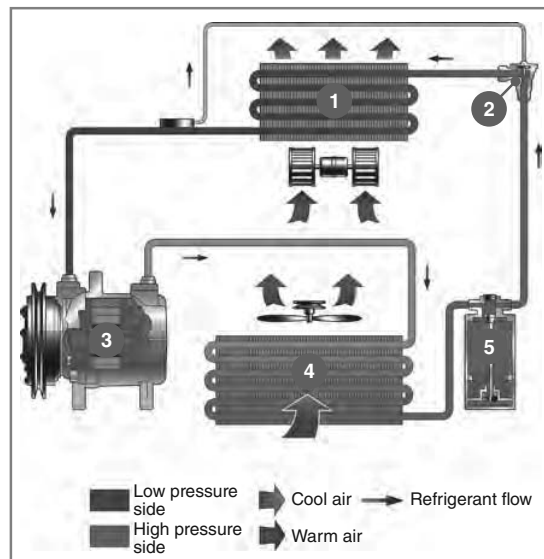

1. Evaporator
2. Expansion valve
3. Compressor
4. Condenser
5. Receiver Drier

**GB**

### Compressors



#### 10PA Compressor

- > A 10 cylinder, double side operating Swash Plate type compressor with fixed displacement, well known for its durability and lack of noise and pulsation
- > Compressor oil: ND-8

#### 10S Compressor

- > The 10S compressor is an improved version of the 10PA type
- > Main differences are size and weight reduction
- > Service valve is no longer used; Hoses connect directly to the compressor body
- > Compressor oil: ND-8

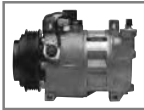

#### 6CA Compressor

- > A single side operating Wobble plate type Compressor
- > 6 Pistons and variable displacement
- > Compressor oil: ND-8



#### 7SB(U) Compressor

- > Single side operating Swash Plate type compressor
- > 7 pistons, variable displacement between 3 or 7 and 100%
- > The variable displacement is external (electronic) or internal (mechanical) controlled
- > Compressor oil: ND-8



#### ES type compressor

- > Electrical driven Scroll compressor; variable displacement
- > Hermetically closed compressor reducing leakage of refrigerant
- > A/C operation also when the engine is switched off
- > Compressor chamber consists of a pair of spiral-shaped scrolls; one fixed and one rotating
- > Compressor oil: ND-11, a highly insulating oil



#### SE / SL Compressor

- > Single side operating Swash Plate compressor
- > 5, 6 or 7 pistons, depending on model
- > External (electronic) controlled variable displacement between 2% and 100%
- > The SE type compressor has no magnetic clutch and is continuously driven
- > Compressor oil: ND-8



#### Scroll (SC) Compressor

- > A rotating type compressor well known for its low noise and high performance
- > Compressor chamber consists of a pair of spiral-shaped scrolls; one fixed and one rotating
- > Compressor oil: ND-8



#### Through Vane (TV) Compressor

- > A rotating type compressor
- > Compressor chamber consists of a rotor with two vanes sliding through the rotor
- > Two different displacements ; 120 or 140 cc
- > Compressor oil: ND-9



**GB**

## Condensers

The condenser is a heat exchanger belonging to the vehicle air conditioning system. Its function is to condense the refrigerant in the A/C cycle. As a heat exchanger, the condenser's structure is similar to that of the radiator, but it has to withstand the high internal pressures (up to 34 Bar) typical for air conditioning systems. DENSO condensers, particularly our most recent applications, have an integrated filter/dryer to ensure greater efficiency of the air conditioning system.

**Dual Flow**

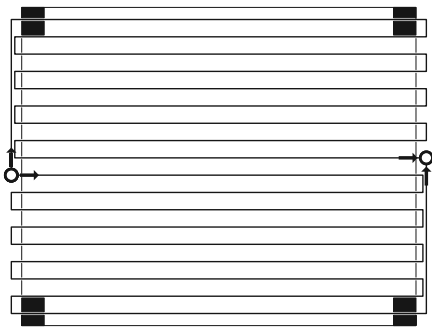

**Triple Flow**

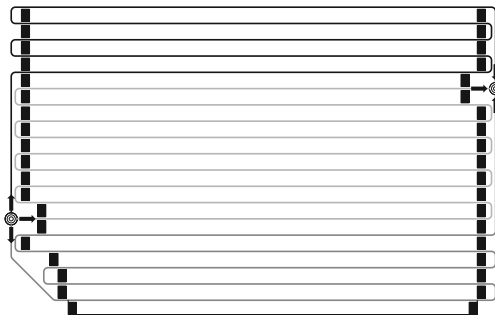

**Multi Flow (U-turn)**

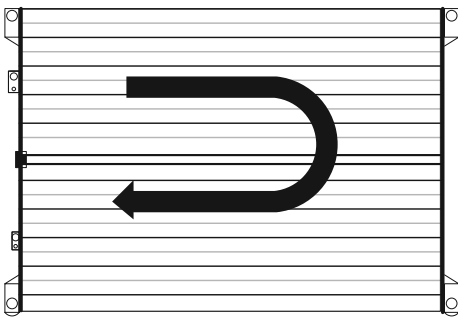

**Multi Flow (S-turn)**

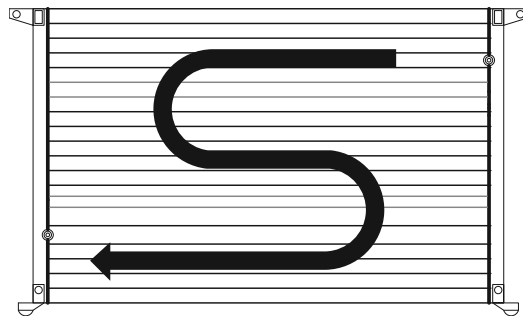

**Super Cool**

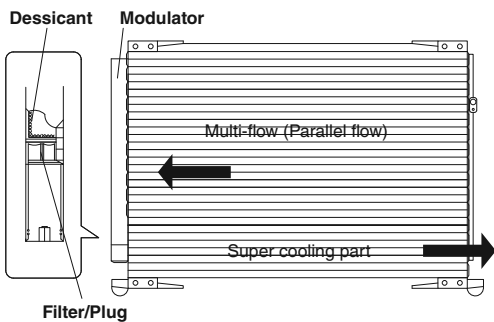

**Function of the Modulator**

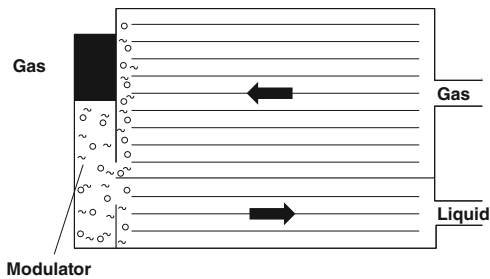

**GB**

### Compressor

Read the compressor installation guide very carefully, before installing the new DENSO compressor. You will find the installation guide in the box, with the new compressor and / or at our aftermarket website.

<http://www.denso-am.eu>

### Compressor Oil



*When replacing a compressor it is necessary to follow the right procedure to determine the right amount of oil in the AC system. Check the compressor installation guide for details. Always make sure you use the specified oil. See the compressor label for details.*



#### DENSO ND-oil 8

DENSO ND-oil 8 is used in piston and rotary type (scroll) compressors with R134a type refrigerant.

**Available in 250cc can:** 997635-8250



#### DENSO ND-oil 9

DENSO ND-oil 9 is used in through vane type compressors with R134a type refrigerant.

**Available in 250cc can:** 446963-2040



#### DENSO ND-oil 11

DENSO ND-oil 11 is used in the electric driven scroll compressors with either R134a or R1234yf type refrigerant.

**Available in 250cc can:** 042198-0080



#### DENSO ND-oil 12

DENSO ND-oil 12 is used in piston and rotary type (scroll) compressors with either R1234yf or R134a type refrigerant.

**Available in 250cc can:** 446963-0300



## D

### Der DENSO Unterschied

Fahrer und ihre Fahrgäste erwarten einen angenehmen Fahrzeuginnenraum, und das auf jeder Fahrt und bei jedem Wetter. Aus diesem Grund verlassen sich Autohersteller rund um die Welt auf die effizienten, zuverlässigen Heizungs-, Lüftungs- und Klimaanlageanteile von DENSO – den führenden Hersteller von Original-Wärmetechnikprodukten der Welt.

DENSO entwickelt nicht nur fortschrittliche Klima- und Motorkühlanlagen für führende Autohersteller, sondern ist mit einem OEM-Marktanteil von 42 % auch weltweit führend in der Herstellung von Klimakompressoren. Dieses überragende technische Knowhow spiegelt sich in der Qualität unseres Klimakompressorensortiments wieder und liefert die internationale Benchmark für Technik und Qualität.

**Die DENSO Klimakompressoren haben eine 100 %-ige Erstausrüsterqualität und bieten eine überragende Zuverlässigkeit sowie eine ausgedehnte Abdeckung des Fahrzeugbestands. Außerdem sind sie in TecDoc einfach zu finden.**

### Klimaanlage

#### Anordnung der Anlag

Die Hauptaufgabe der Klimaanlage ist es, im Fahrzeuginnenraum ein angenehmes Klima zu schaffen und aufrecht zu erhalten, indem sie die in den Fahrzeuginnenraum geblasene Luft kühlt oder erwärmt. Außerdem reduziert sie die Luftfeuchtigkeit, Staub und Gerüche im Fahrzeuginnenraum. Die Klimaanlage besteht im Allgemeinen aus einem Heizungs-, einem Verdampfer- und einem Lüftungskreislauf mit einem Gebläse, Luftkanälen und Luftfilter.

Die Hauptbauteile des Kältekreislaufs:

- > Vom Automotor angetriebener Kompressor
- > Kondensator
- > Sammelbehälter mit Trocknereinsatz
- > Expansionsventil
- > Verdampfer

Die Einzelteile der Anlage sind über verschiedene Schläuche und Rohre miteinander verbunden.

#### Funktionsweise einer Kfz-Klimaanlage

##### DENSO Kompressor

Der Kompressor saugt das gasförmige Kältemittel unter niedrigem Druck mit niedriger Temperatur vom Verdampfer an und verdichtet es zu einem Hochtemperatur- und Hochdruckgas. Anschließend strömt das Kältemittel dann zum Kondensator. Der Kompressor wird über Riemen und Kupplung oder Riemenscheibe vom Motor angetrieben.

##### DENSO Kondensator

Der Kondensator ist ein Wärmetauscher, der dem vom Verdichter zugeführten gasförmigen Hochtemperatur- und Hochdruck-Kältemittel Wärme entzieht und das Kältemittel verflüssigt. Das verflüssigte Kältemittel strömt zum Sammelbehälter mit Trocknereinsatz.

##### DENSO Sammelbehälter mit Trocknereinsatz

Der Sammelbehälter mit Trocknereinsatz speichert das Kältemittel, bis es vom Verdampfer benötigt wird, und gewährleistet so, dass nur verflüssigtes Kältemittel zum Verdampfer strömt. Zweitens wird das Kältemittel gefiltert und getrocknet. Nach der Trennung von Flüssigkeit und Gas strömt das flüssige Kältemittel zum Expansionsventil.

##### DENSO Expansionsventil

Das Expansionsventil spritzt Kältemittel in den Verdampfer ein, wobei das Kältemittel aus dem flüssigen Hochdruck-Zustand hoher Temperatur in ein Flüssigkeits-Gas-Gemisch niedriger Temperatur unter niedrigem Druck wechselt.

##### DENSO Verdampfer

Der Verdampfer verdampft das Kältemittel niedriger Temperatur unter niedrigem Druck. Zum Verdampfen des Kältemittels wird viel Wärme benötigt, die der Verdampfer der warmen Luft entzieht, die über die Verdampferrippen strömt, und so den Fahrzeuginnenraum kühlt. Das gesamte flüssige Kältemittel wechselt in die Gasphase und strömt zum Kompressor, wo der Kreislauf erneut beginnt.

##### DENSO Druckschalter oder Druckwächter

Der Druckschalter (oder Druckwächter) ist eine Sicherheitsvorrichtung, die die Einzelteile des Kältemittelkreislaufs vor einem zu hohen oder zu niedrigen Druck schützt. Zweitens sendet der Drucksensor das Signal an ein Steuergerät, das dieses Signal zum Berechnen des richtigen variablen Fördervolumen des elektronisch gesteuerten variablen Kompressors verwendet.

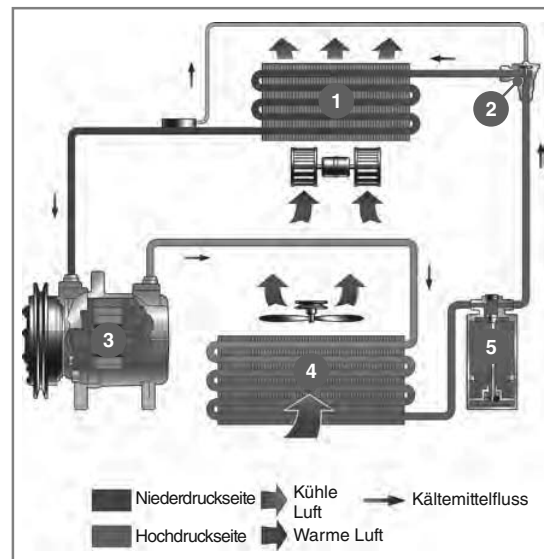

1. Verdampfer
2. Expansionsventil
3. Kompressor
4. Kondensator
5. Sammelbehälter mit Trocknereinsatz



### D

## Kompressoren



### Beschreibung: Kompressor 10PA

- > Ein doppelseitig wirkender 10-Zylinder-Taumelscheibenkompressor mit festem Fördervolumen, bekannt für seine Dauerhaftigkeit, Laufruhe und Schwingungsarmut.
- > Kompressoröl: ND-8

### Beschreibung: Kompressor 10S

- > Wesentlich verbesserte Version des 10PA Kompressors
- > Die wichtigsten Unterschiede liegen in der Reduzierung von Größe und Gewicht.
- > Keine Anschlußplatte mehr; die Schläuche werden direkt am Kompressorgehäuse angeschlossen.
- > Kompressoröl: ND-8

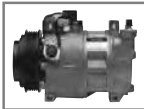

### Beschreibung: Kompressor 6CA

- > Ein einseitig arbeitender Taumelscheibenkompressor
- > 6 Kolben und variables Fördervolumen
- > Kompressoröl: ND-8



### Beschreibung: Kompressor 7SB(U)

- > Einseitig arbeitender Taumelscheibenkompressor
- > 7 Kolben, variables Fördervolumen zwischen 3 % oder 7 % und 100 %.
- > Fördervolumen wird extern (elektronisch) oder intern (mechanisch) geregelt
- > Kompressoröl: ND-8



### Beschreibung: ES-Kompressor

- > Elektrisch betriebener Spiralkompressor mit variablem Hub
- > Hermetisch abgeschlossener Kompressor zur Reduzierung von Kältemittelleckage
- > Klimaanlagebetrieb auch bei ausgeschaltetem Motor
- > Kompressorkammer besteht aus einem Paar Spiralen, von denen eine fixiert ist und eine rotiert
- > Kompressoröl: ND-11, ein stark isolierendes Öl

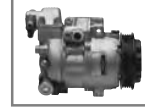

### Beschreibung: Kompressor SE / SL

- > Einseitig wirkender Taumelscheibenkompressor
- > 5, 6 oder 7 Kolben je nach Modell
- > Extern (elektronisch) geregeltes Fördervolumen zwischen 2 % und 100 %.
- > Keine Magnetkupplung, Kompressor wird kontinuierlich angetrieben.
- > Kompressoröl: ND-8



### Beschreibung: Scroll (SC) Kompressor

- > Ein Schneckenkompressor, bekannt für seine Laufruhe und hohe Leistungsfähigkeit.
- > Kompressorkammer besteht aus zwei spiralförmigen Schnecken; eine fest und eine drehend.
- > Kompressoröl: ND-8



### Beschreibung: Flügelzellenkompressor

- > Flügelzellenkompressor
- > Kompressorkammer besteht aus einem Rotor mit zwei durch den Rotor gleitenden Flügeln.
- > Zwei verschiedene Fördervolumen: 120 cm<sup>3</sup> oder 140 cm<sup>3</sup>.
- > Kompressoröl: ND-9



## D

### Kondensatoren

Der Kondensator ist ein Wärmetauscher und gehört zur Klimaanlage des Fahrzeugs. Seine Funktion besteht darin, das Kältemittel im Zyklus der Klimaanlage zu kondensieren. Der Aufbau eines Kondensators, der als Wärmetauscher verwendet wird, ist dem eines Kühlers ähnlich, aber er muss höheren Innendrücken (bis zu 34 Bar) standhalten können, die für Klimaanlagen typisch sind. Die Kondensatoren von DENSO und dabei insbesondere die Kondensatoren in den neuesten Anwendungen, sind mit einem integrierten Filter-/Trocknersystem ausgerüstet, um eine größere Leistungsfähigkeit der Klimaanlage zu gewährleisten.

**Zweiflutig**

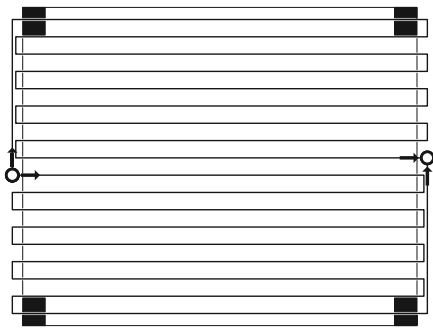

**Dreifachfluss**

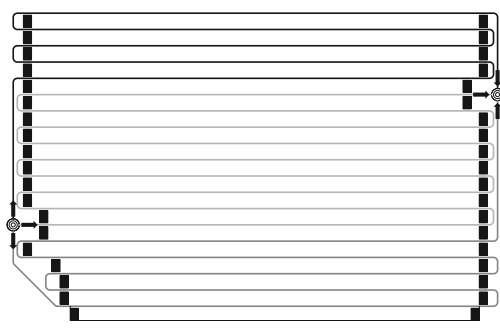

**Mehrfachfluss (180°-Kurve)**

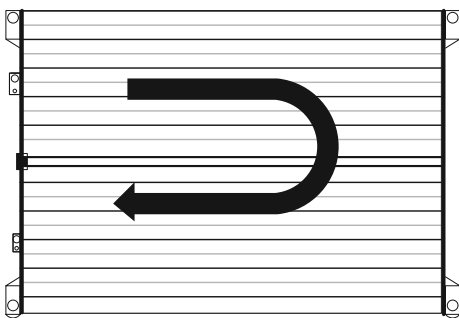

**Mehrfachfluss (S-Kurve)**

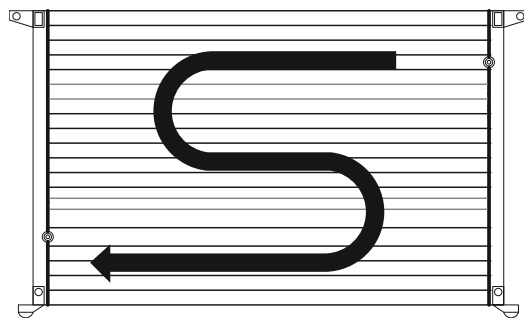

**Supercooling**

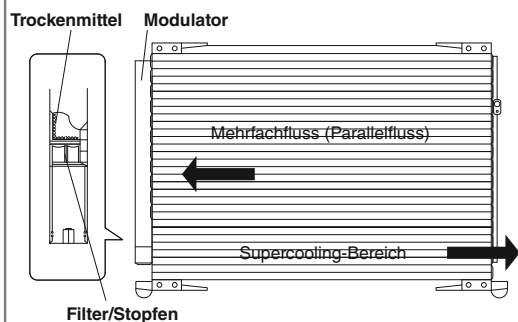

**Funktionsweise des Modulators**

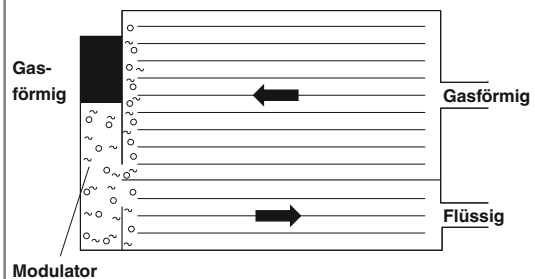

### D

## Kompressor

Bitte lesen Sie die Kompressoreinbauanleitung sorgfältig durch, bevor Sie den neuen DENSO Kompressor einbauen. Die Einbauanleitung finden Sie in der Verpackung des neuen Kompressors oder auf unserer Aftermarket Webseite.

<http://www.denso-am.de>

## Kompressoröl



*Beim Austausch eines Kompressors ist es wichtig, die richtigen Arbeitsschritte einzuhalten, um sicherzustellen, dass sich die korrekte Menge an Öl im Klimasystem befindet. Anweisungen finden Sie dazu in der Kompressoreinbauanleitung. Achten Sie immer darauf, nur das vorgeschriebene Kompressoröl zu verwenden. Die Angaben finden Sie auf dem Kompressor-Typenschild.*



### DENSO ND-8 Öl

DENSO ND-8 Öl wird bei Hubkolben- und Drehkolbenkompressoren (Scrollkompressoren) mit R134a Kältemittel verwendet.

**Erhältlich im 250ccm-Gebinde:** 997635-8250



### DENSO ND-9 Öl

DENSO ND-9 Öl wird bei Flügelzellenkompressoren mit R134a Kältemittel verwendet.

**Erhältlich im 250ccm-Gebinde:** 446963-2040



### DENSO ND-11 Öl

DENSO ND-11 Öl bei elektrischen Scrollkompressoren mit R134a oder R1234yf Kältemittel verwendet.

**Erhältlich im 250ccm-Gebinde:** 042198-0080



### DENSO ND-12 Öl

DENSO ND-12 Öl wird bei Hubkolben- und Drehkolbenkompressoren (Scrollkompressoren) mit R1234yf oder R134a Kältemittel verwendet.

**Erhältlich im 250ccm-Gebinde:** 446963-0300



## La diferencia de DENSO

Los conductores y sus pasajeros cuentan con que el habitáculo sea confortable en todos sus trayectos que realicen, cualquiera que sea el tiempo. Ésta es la razón por la que los constructores de automóviles en todo el mundo confían en DENSO —el primer fabricante mundial de primeros equipos de control térmico— para el suministro de elementos de sistemas de calefacción, ventilación y aire acondicionado fiables y de alto rendimiento.

No sólo en el desarrollo de sistemas avanzados de aire acondicionado y de refrigeración del motor para los principales constructores de automóviles, DENSO está también en la vanguardia mundial en el campo de los compresores de aire acondicionado con una cuota del mercado de primeros equipos del 42%. Estos excelentes conocimientos técnicos se reflejan en la calidad de nuestro programa de compresores de aire acondicionado para la posventa, estableciendo un referente internacional por su tecnología y calidad.

**En un programa con toda la calidad de los primeros equipos, los compresores de aire acondicionado DENSO ofrecen una fiabilidad excepcional y una amplia cobertura del parque automovilístico, con facilidad de consulta en TecDoc.**

### Sistema de aire acondicionado

#### Disposición del sistema

La principal función de un sistema de aire acondicionado es mantener el aire en el interior del habitáculo en unas condiciones que ofrezcan un ambiente agradable, calentando o enfriando para ello el aire que se ventila en el habitáculo. Además, tiene también que reducir la humedad, el polvo y los olores que pudiera haber en este espacio. Para realizar estas funciones, el sistema de aire acondicionado de un vehículo consta generalmente de un calentador, un evaporador, y un sistema de ventilación constituido por un ventilador, unos conductos de aire y un purificador de aire.

Los principales elementos del ciclo de refrigeración son:

- > El compresor accionado por el motor del vehículo.
- > El condensador.
- > El filtro secador-acumulador.
- > La válvula de expansión.
- > El evaporador.

Estos elementos del sistema están conectados entre sí mediante distintas tuberías y manguitos.

### Funcionamiento del sistema de aire acondicionado del automóvil

#### Compresor DENSO

El compresor aspira el fluido refrigerante en estado gaseoso a baja temperatura y baja presión proveniente del evaporador, y lo comprime resultando en un gas a alta temperatura y alta presión. Este refrigerante se descarga y suministra al condensador. El motor acciona el compresor mediante una transmisión por correa y p Polea con embrague.

#### Condensador DENSO

Un condensador es un intercambiador de calor que extrae calor del refrigerante gaseoso a alta temperatura y alta presión suministrado por el compresor, condensando el refrigerante al estado líquido. Una vez líquido, el refrigerante fluye al filtro secador-acumulador.

#### Filtro secador-acumulador DENSO

El filtro secador-acumulador almacena el refrigerante en espera de que se produzca la demanda de refrigerante por parte del evaporador, asegurando que sólo el refrigerante en estado líquido pase al evaporador. El refrigerante se filtra y seca, y después de la separación del líquido y el gas, el refrigerante líquido fluye a la válvula de expansión.

#### Válvula de expansión DENSO

La válvula de expansión inyecta el refrigerante en el evaporador, transformando el refrigerante de un líquido a alta temperatura y alta presión, a una mezcla de líquido y gas a baja temperatura y baja presión.

#### Evaporador DENSO

En el evaporador se evapora el refrigerante a baja temperatura y baja presión. Para producir la evaporación del refrigerante se necesita una gran cantidad de calor, un calor que el evaporador absorbe del aire caliente que pasa entre las aletas del evaporador, produciéndose así el enfriamiento del habitáculo del vehículo. Con ello, todo el refrigerante líquido pasa al estado gaseoso, y el proceso se repite de nuevo.

#### Presostato DENSO

El presostato es un dispositivo de seguridad que protege los elementos del circuito de refrigeración contra presiones demasiado elevadas o demasiado bajas. En segundo lugar, el presostato emite una señal a la unidad de control que emplea dicha señal para calcular el caudal necesario del compresor controlado por un variador electrónico.

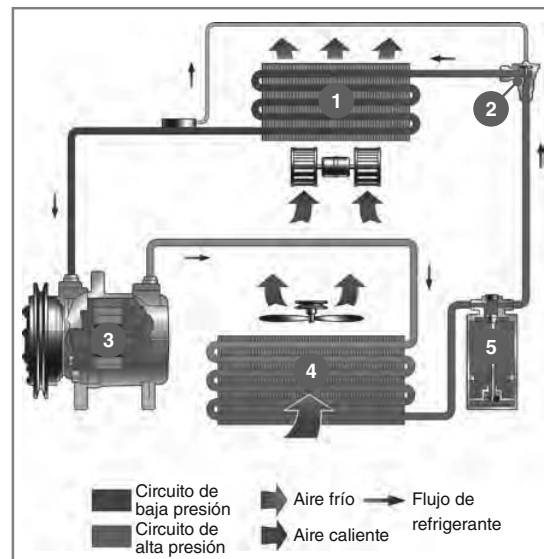

1. Evaporador
2. Válvula de expansión
3. Compresor
4. Condensador
5. Filtro secador-acumulador

### E

## Compresores



### Compresor 10PA

- > Compresor de 10 cilindros actuados por plato oscilante bilateral de caudal constante, reconocido por su durabilidad y la ausencia de ruido y pulsaciones.
- > Aceite de compresor: ND-8.

### Compresor 10S

- > El compresor 10S es una versión mejorada del tipo 10PA.
- > Las principales diferencias son el tamaño y peso reducidos.
- > No se emplea más la válvula de suministro; los manguitos se conectan directamente a la carcasa del compresor.
- > Aceite de compresor: ND-8.



### Compresor 6CA

- > Compresor de plato oscilante simple.
- > 6 pistones y caudal variable.
- > Aceite de compresor: ND-8.



### Compresor 7SB(U)

- > Compresor de plato oscilante simple.
- > 7 pistones, caudal variable entre 3% o 7%, y 100%.
- > Caudal regulado externa (regulación electrónica) o internamente (regulación mecánica).
- > Aceite de compresor: ND-8.



### Compresor ES

- > Compresor de espiral de accionamiento eléctrico; caudal variable.
- > Compresor herméticamente cerrado que reduce la fuga de refrigerante.
- > Aire acondicionado en funcionamiento también con el motor parado.
- > Cámara de compresión constituida por un par de espirales planas, una fija y la otra rotativa.
- > Aceite de compresor: ND-11, de muy buenas características aislantes.



### Compresor SE / SL

- > Compresor de plato oscilante simple.
- > Modelos de 5, 6 y 7 pistones.
- > Caudal variable de regulación externa (electrónica) entre 2% y 100%.
- > Compresor SE de accionamiento continuo sin embrague electromagnético.
- > Aceite de compresor: ND-8.



### Compresor de espiral SC

- > Tipo de compresor rotativo reconocido por sus altas prestaciones y bajo ruido.
- > Cámara de compresión constituida por un par de espirales planas, una fija y la otra rotativa.
- > Aceite de compresor: ND-8.



### Compresor de paletas TV

- > Compresor de tipo rotativo.
- > Cámaras de compresión formadas por un rotor con dos paletas deslizantes que atraviesan el propio rotor.
- > Dos cilindradas: 120 cm<sup>3</sup> y 140 cm<sup>3</sup>.
- > Aceite de compresor: ND-9.



**E**

## Condensadores

El condensador es un intercambiador de calor que se instala en el sistema de aire acondicionado del vehículo. Su función es condensar el refrigerante del circuito de aire acondicionado. Tratándose de un intercambiador de calor, la construcción del condensador es similar a la del radiador de refrigeración, pero debe resistir las elevadas presiones internas –hasta 34 bar– que se producen normalmente en los sistemas de aire acondicionado. Los condensadores DENSO, particularmente en nuestras aplicaciones más recientes, incorporan un filtro secador para asegurar un mayor rendimiento del sistema de aire acondicionado.

**Flujo doble**

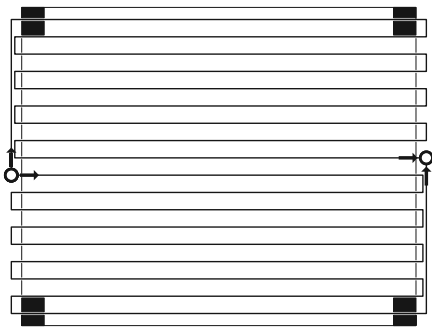

**Flujo triple**

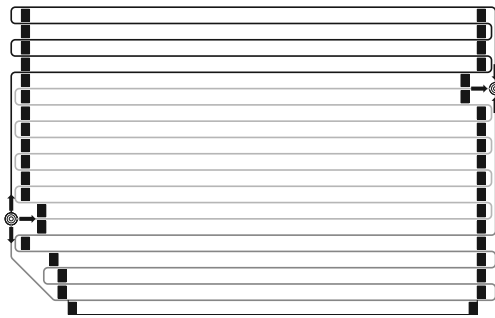

**Flujo múltiple en "U"**

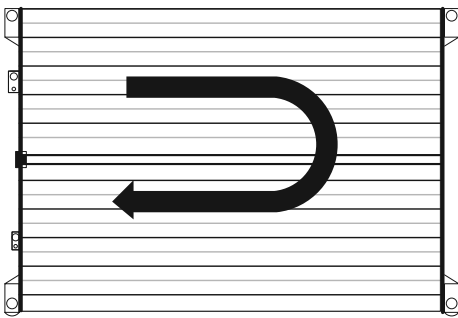

**Flujo múltiple en "S"**

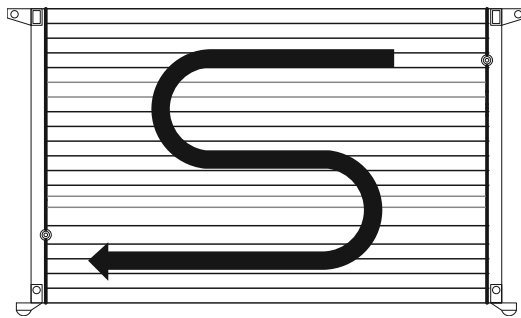

**Super Cool (enfriamiento rápido)**

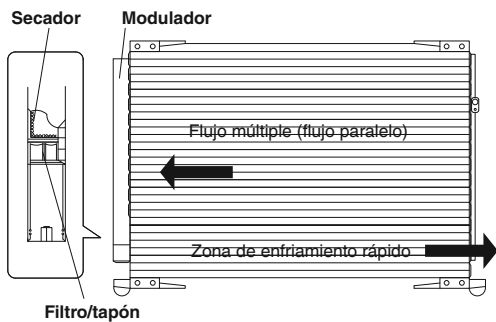

**Función del modulador**

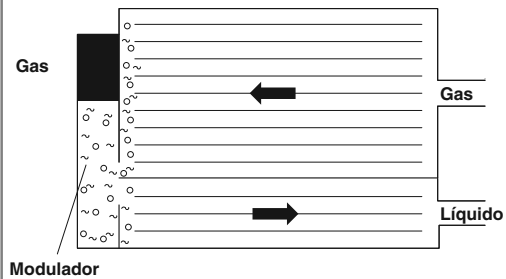

### E

## Compresor

Lea atentamente la guía de instalación antes de instalar el compresor nuevo DENSO. Encontrará la guía de instalación en la caja, con el compresor nuevo y/o en nuestra web para aftermarket.

<http://www.denso-am.eu>

## Aceite del compresor



*Cuando sustituya un compresor es necesario seguir el procedimiento correcto para determinar la cantidad adecuada de aceite en el sistema de A/C. Revise la guía de instalación para mayor información. Asegurese siempre de usar el aceite especificado. Mire la etiqueta del compresor para mayor información.*



### DENSO aceite ND-8

El DENSO aceite ND-8 se utiliza en los compresores de tipo piston y rotativo (scroll) con refrigerante R134a.

**Disponible en envase de 250cc:** 997635-8250



### DENSO aceite ND-9

El DENSO aceite ND-9 se utiliza en los compresores de paletas con refrigerante R134a.

**Disponible en envase de 250cc:** 446963-2040



### DENSO aceite ND-11

El DENSO aceite ND-11 se utiliza en los compresores eléctricos de tipo scroll tanto con refrigerante R134a como con R1234yf.

**Disponible en envase de 250cc:** 042198-0080



### DENSO aceite ND-12

El DENSO aceite ND-12 se utiliza en los compresores de tipo piston y rotativo (scroll) con refrigerante R1234yf o R134a.

**Disponible en envase de 250cc:** 446963-0300



## Skillnaden med DENSO

Förare och passagerare förväntar sig en komfortabel resa varje gång, i alla väder. Därför förlitar sig biltillverkare över hela världen på DENSO – världens ledande tillverkare av originalvärmeprodukter – för effektiva och tillförlitliga värme-, ventilations- och luftkonditioneringskomponenter.

DENSO utvecklar inte bara avancerade luftkonditionerings- och motorkylsystem för ledande biltillverkare, utan är också marknadsledande på området luftkonditioneringskompressorer, med en marknadsandel på 42 % av marknaden. Det enastående kunnandet märks på den höga kvaliteten på våra kompressorer för eftermarknaden, och sätter den internationella standarden för teknikoch kvalitet.

**DENSO:s kompressorer har en enastående tillförlitlighet, passar de flesta bilmodeller och kan lätt identifieras i TecDoc.**

### Luftkonditioneringsystem

#### Uppbyggnad

Luftkonditioneringsens huvuduppgift är att upprätthålla en komfortabel luftmiljö i kupén genom att kyla ned eller värma upp den inkommande luften. Dessutom minskar systemet luftfuktigheten och mängden damm och lukter i kupén. Luftkonditioneringsystemet utgörs normalt av en värmare, en förångare och ett ventilationssystem med en fläkt, luftkanaler, och luftrenare.

Huvudkomponenterna i anläggningen är:

- > Kompressor som drivs av bilmotorn
- > Kondensator
- > Torkfilter
- > Expansionsventil
- > Förångare

Komponenterna är sammankopplade med rör och slangar.

#### Funktion:

##### DENSO kompressor

Kompressorn suger in det gasformiga kylmediet med lågt tryck och temperatur från förångaren och komprimerar det till en gas med högt tryck och temperatur. Kylmediet går sedan ut till kondensorn. Motorn driver kompressorn via en rem och koppling, eller via en remskiva.

##### DENSO kondensator

En kondensator är en värmväxlare som extraherar värmen ur kylmediet från kompressorn och kondenserar det till vätska. När kylmediet kondenserats överförs det till torkfiltret.

##### DENSO torkfilter

Torkfiltret lagrar kylmediet tills förångaren behöver det, så att bara kondenserat kylmedium överförs till förångaren. Nästa steg är att kylmediet filtreras och torkas. Efter separeringen av gas och vätska överförs kylmediet i vätskeform till expansionsventilen.

##### DENSO expansionsventil

Expansionsventilen sprutar in kylmediet i förångaren så att det övergår från en vätska med högt tryck och temperatur till en gas-/vätskeblandning med lågt tryck och temperatur.

##### DENSO förångare

Förångaren förvandlar kylmediet med lågt tryck och temperatur till ånga. När kylmediet förångas krävs mycket värme, vilken förångaren absorberar från den varma luften som passerar över förångarflänsarna, så att kupéluften kyls ned. All vätska övergår i gasform och överförs till kompressorn. Processen upprepas sedan igen.

##### DENSO tryckkontakt eller tryckgivare

Tryckkontakten (eller tryckgivaren) är en säkerhetsfunktion som skyddar komponenterna i systemet från för höga eller för låga tryck. Tryckgivaren skickar sedan signalen till en styrenhet som använder den för att beräkna rätt variabel volym för den elektroniskt styrda kompressorn.

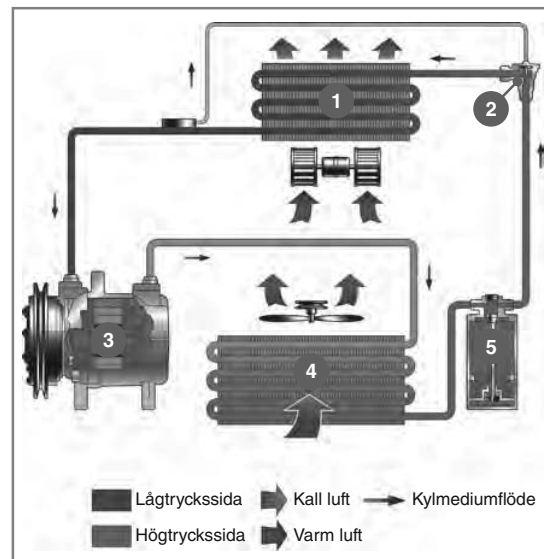

1. Förångare
2. Expansionsventil
3. Kompressor
4. Kondensator
5. Torkfilter



SE

### Kompressorer



#### Beskrivning av 10PA kompressor

- > Tiocylindrig dubbelverkande swash-platekompressor, med fast slagvolym, och som är välkänd för sin robusta konstruktion och sina låga ljud- och pulseringsnivåer.
- > Kompressorolja: ND-8

#### Beskrivning av 10S kompressor

- > Modell 10S är en förbättrad version av 10PA
- > De huvudsakliga förbättringarna är mindre storlek och lägre vikt
- > En underhållsventil används inte längre; slangarna ansluts direkt på kompressorhuset
- > Kompressorolja: ND-8

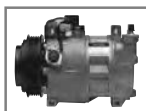

#### Beskrivning av 6CA kompressor

- > Enkelverkande wobble-platekompressor
- > 6 kolvar och variabel slagvolym
- > Kompressorolja: ND-8



#### Beskrivning av 7SB(U) kompressor

- > Enkelverkande swash-platekompressor
- > 7 kolvar och variabel volym mellan 3 eller 7 och 100 %
- > Slagvolymen styrs externt (elektroniskt) eller internt (mekaniskt)
- > Kompressorolja: ND-8



#### Beskrivning av ES kompressor

- > Eldriven skruvkompressor, variabel volym
- > Hermetiskt sluten kompressor, vilket minskar risken för kylmedelsläckage
- > Växelströmsdrift även när motorn är avstängd
- > Kompressorkammaren består av ett par spiralformade rullar; en fast och en roterande
- > Kompressorolja: ND-11 olja med mycket god isoleringsförmåga

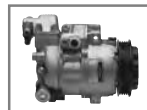

#### Beskrivning av SE / SL kompressor

- > Enkelverkande swash-platekompressor
- > 5, 6 eller 7 kolvar, beroende på modell
- > Externt (elektroniskt) styrd slagvolym mellan 2 % och 100 %
- > SE-kompressorn har kontinuerlig drivning och saknar magnetisk koppling
- > Kompressorolja: ND-8



#### Beskrivning av (SC) skrollkompressor

- > Kompressor av rotationstyp som är välkänd för sin låga ljudnivå och höga prestanda
- > Kompressorkammaren består av ett par spiralformade rullar, en fast och en roterande
- > Kompressorolja: ND-8



#### Beskrivning av Through Vane (TV) kompressor (rotor)

- > Rotorkompressor
- > Kompressorkammaren innehåller en rotor med två vingar som glider genom rotorn
- > Två olika volymer; 120 eller 140 cc
- > Kompressorolja: ND-9



SE

## Kondensorer

Kondensorn är en värmeväxlare som utgör en del av fordonets luftkonditioneringsystem. Dess funktion är att kondensera kylmediet under luftkonditioneringscykeln. Som värmeväxlare liknar kondensatorns uppbyggnad kylarens, men den måste kunna motstå de höga tryck (upp till 34 bar) som normalt förekommer i luftkonditioneringsystem. DENSO kondensatorer, speciellt våra senaste tillämpningar, har ett integrerat torkfiltersystem som ger ännu högre effektivitet i systemet.

Dubbelflöde

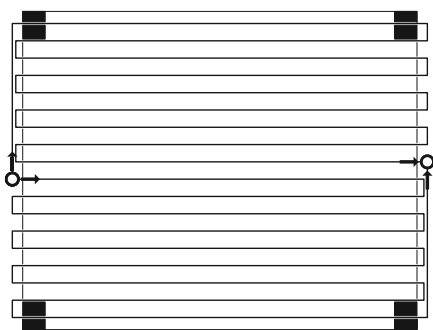

Trippelflöde



Multiflöde (U-kurva)

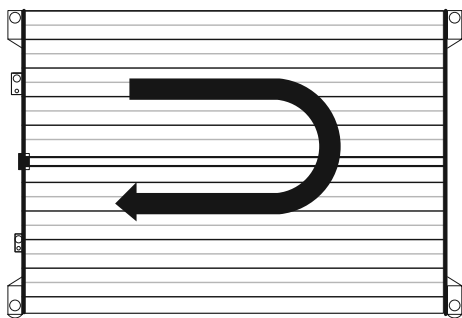

Multiflöde (S-kurva)

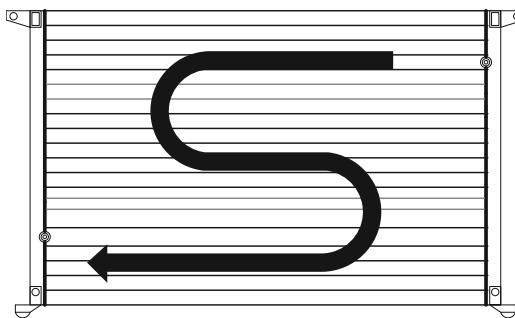

Super Cool

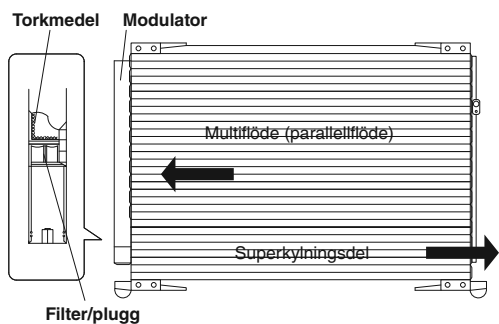

Modulatorns funktion

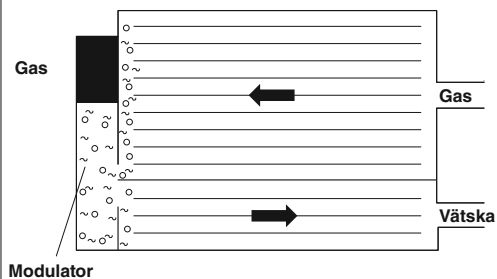

SE

### Kompressor

Läs kompressorinstallationsanvisningarna mycket noga, innan du installerar nya DENSO kompressorn. Du kommer hitta installationsguiden i rutan med den nya kompressor och / eller på vår eftermarknads hemsida.

<http://www.denso-am.eu>

### Kompressorolja



*Vid byte av kompressor är det nödvändigt att följa rätt förfarande för att bestämma rätt mängd olja i AC-systemet. Kontrollera kompressorinstallationsguiden för mer information. Se alltid till att du använder den angivna oljan. Sekompressoretiketten för detaljer.*



#### DENSO ND-olja 8

DENSO ND-olja 8 används i kolv och roterande typ (scroll) kompressorer med R134a köldmedel.

Finns i 250cc kan: 997635-8250



#### DENSO ND-olja 9

DENSO ND-olja 9 används genom ving kompressorer med R134a köldmedel.

Finns i 250cc kan: 446963-2040



#### DENSO ND-olja 11

DENSO ND-olja 11 används i eldrivna scrollkompressorer med antingen R134a eller R1234yf köldmedel.

Finns i 250cc kan: 042198-0080



#### DENSO ND-olja 12

DENSO ND-olja 12 används i kolv och roterande typ (scroll) kompressorer med R1234yf eller R134a köldmedel.

Finns i 250cc kan: 446963-0300



## Co wyróżnia DENSO?

Kierowcy i ich pasażerowie oczekują komfortowej temperatury w kabinie w czasie podróży, w każdych warunkach pogodowych. To dlatego producenci samochodów na całym świecie polegają na firmie DENSO, która jest światowym liderem w produkcji na pierwszy montaż wydajnych i niezawodnych systemów ogrzewania, wentylacji i klimatyzacji.

DENSO jest nie tylko twórcą zaawansowanych układów klimatyzacji i chłodzenia silników dla wiodących producentów samochodów, DENSO jest również światowym liderem w zakresie sprężarek do układów klimatyzacji - z 42% udziałem w rynku producentów oryginalnego wyposażenia. Ta wyjątkowa wiedza inżynierska znajduje odzwierciedlenie w jakości naszego programu sprężarek dla rynku części zamiennych - stanowiącego międzynarodowy punkt odniesienia dla technologii oraz jakości.

**Obejmując 100% zakres produktów o jakości OE, sprężarki do układów klimatyzacji firmy DENSO zapewniają nadzwyczajną niezawodność, przydatność dla szerokiego parku samochodowego, oraz przewidują możliwość łatwego, właściwego dobrania w dokumentacji technicznej.**

### Układ klimatyzacji

#### Opis układu

Głównym zadaniem układu klimatyzacji jest utrzymanie powietrza w kabinie pasażerskiej na poziomie komfortowego środowiska, poprzez chłodzenie lub nagrzewanie powietrza wdmuchiwanego do kabiny pasażerskiej. Oprócz tego, będzie on również zmniejszał wilgotność, zapylenie i zapachy w kabinie. W celu wykonania tych operacji, samochodowy układ klimatyzacji składa się z nagrzewnicy, parownika, oraz układu wentylacyjnego obejmującego dmuchawę, kanały powietrzne, oraz osuszacza powietrza.

Główne komponenty cyklu chłodzenia:

- > Sprężarka napędzana silnikiem pojazdu
- > Skraplacz
- > Osuszacz
- > Zawór rozprężny
- > Parownik

#### Zasada działania samochodowego układu klimatyzacji

##### Sprężarka DENSO

Sprężarka zasysa gazowy czynnik chłodniczy o niskiej temperaturze i niskim ciśnieniu z parownika, a następnie spręża go uzyskując gaz o wysokiej temperaturze i wysokim ciśnieniu. Czynnik chłodniczy jest następnie uwalniany i kierowany do skraplacza. Silnik poprzez pasek i sprzęgło lub koło pasowe, napędza sprężarkę.

##### Skraplacz DENSO

Skraplacz jest wymiennikiem ciepła, który usuwa ciepło z gazowego czynnika chłodniczego o wysokiej temperaturze i wysokim ciśnieniu, podawanego przez sprężarkę i skrapla go do postaci ciekłej. Po uzyskaniu postaci ciekłej czynnik chłodniczy przepływa do osuszacza.

##### Osuszacz DENSO

Osuszacz będzie przetrzymywał czynnik chłodniczy do chwili jego zapotrzebowania przez parownik, zapewniając, że do parownika wpłynie wyłącznie ciekły czynnik chłodniczy. Następnie czynnik chłodniczy jest filtrowany i osuszany. Po rozdzieleniu gazu i cieczy, ciekły czynnik chłodniczy przepływa do zaworu rozprężnego.

##### Zawór rozprężny DENSO

Zawór rozprężny wtryskuje czynnik chłodniczy do parownika, przekształcając go z cieczy o wysokim ciśnieniu i wysokiej temperaturze w mieszaninę gazu i cieczy o niskim ciśnieniu i niskiej temperaturze.

##### Parownik DENSO

Parownik odparowuje czynnik chłodniczy o niskim ciśnieniu i niskiej temperaturze. Przy odparowywaniu czynnika chłodniczego wymagana jest duża ilość ciepła, która jest absorbowana przez parownik z nagrzanego powietrza przechodzącego przez żeberka parownika, tym sposobem chłodząc kabinę pasażerską. Cała ciecz przechodzi w stan gazowy i przepływa do sprężarki. Następnie opisywany proces jest powtarzany.

##### Presostat lub czujnik ciśnienia DENSO

Presostat (lub czujnik ciśnienia) jest urządzeniem zabezpieczającym, które zabezpiecza komponenty cyklu czynnika chłodniczego przed zbyt wysokim ciśnieniem lub zbyt niskim ciśnieniem.

Poza tym, czujnik ciśnienia wysyła sygnał do jednostki sterującej, która wykorzystuje ten sygnał do obliczenia prawidłowego skoku elektronicznie sterowanej sprężarki o zmiennej pojemności.

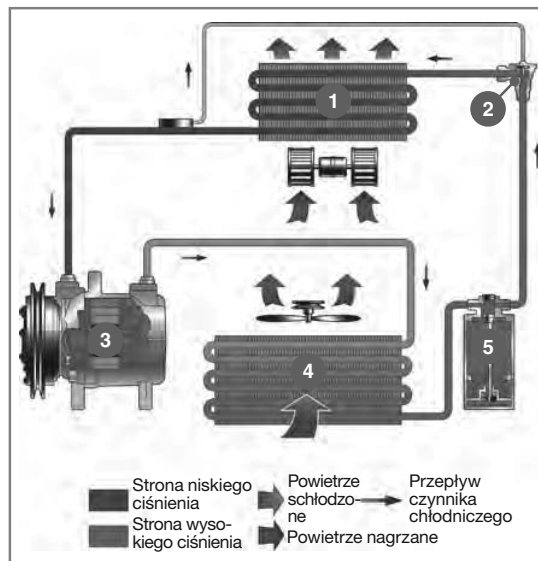

1. Parownik
2. Zawór rozprężny
3. Sprężarka
4. Skraplacz
5. Osuszacz

PL

## Sprężarki



### Opis sprężarki 10PA

- > 10 cylindrowa, sprężarka o dwustronnym działaniu typu Swash Plate - ze stałym skokiem, dobrze znana ze swej trwałości oraz z ograniczonej emisji hałasu i pulsacji
- > Olej sprężarkowy: ND-8

### Opis sprężarki 10S

- > Sprężarka 10S to udoskonalona wersja typu 10PA
- > Główne różnice to zmniejszona wielkość i ciężar
- > Nie ma już zaworu roboczego: węże podłączone są bezpośrednio do korpusu sprężarki
- > Olej sprężarkowy: ND-8



### Opis sprężarki 6CA

- > Sprężarka o jednostronnym działaniu ze zmiennym skokiem cylindrów
- > 6 tłokowa ze zmiennym skokiem
- > Olej sprężarkowy: ND-8



### Opis sprężarki 7SB(U)

- > Sprężarka o jednostronnym działaniu ze stałym skokiem
- > 7 tłoków, zmienny skok pomiędzy 3 i 7 oraz 100%
- > Regulacja skoku jest dokonywana zewnętrznie (elektronicznie) lub wewnętrznie (mechanicznie)
- > Olej sprężarkowy: ND-8



### Sprężarka typu ES (spiralna o napędzie elektrycznym)

- > Napędzana elektrycznie sprężarka spiralna o zmiennej wydajności
- > Hermetyczna obudowa zapobiegająca wyciekom czynnika chłodniczego
- > Możliwość włączenia układu klimatyzacji nawet podczas postoju z wyłączonym silnikiem
- > W komorze roboczej sprężarki znajdują się dwa elementy: spirala stała i obrotowa
- > Olej sprężarkowy: ND-11, nieprzewodzący prądu elektrycznego

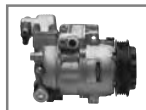

### Opis sprężarki SE / SL

- > Sprężarka o jednostronnym działaniu ze stałym skokiem
- > 5, 6 lub 7 tłoków, zależnie od modelu
- > Zewnętrznie (elektronicznie) regulowany skok pomiędzy 2% i 100%
- > Sprężarka typu SE nie posiada sprzęgła elektromagnetycznego i jest stale napędzana
- > Olej sprężarkowy: ND-8



### Opis sprężarki spiralnej (SC)

- > Sprężarka typu rotacyjnego doskonale znana z racji niskiego poziomu hałasu i wysokiej wydajności
- > Komora sprężarki składa się z pary spiralnie ukształtowanych elementów spiralnych; jednego stałego i drugiego obracającego się
- > Olej sprężarkowy: ND-8



### Opis sprężarki łopatkowej (TV)

- > Sprężarka typu rotacyjnego
- > Komora sprężarki składa się z wirnika z dwoma łopatkami, ślizgającymi się w korpusie wirnika
- > Dwa różne skoki ; 120 lub 140 cm<sup>3</sup>
- > Olej sprężarkowy: ND-9



PL

## Skraplacze

Skrapłacz jest wymiennikiem ciepła należącym do układu klimatyzacji pojazdu. Jego zadaniem jest skroplenie czynnika chłodniczego w cyklu układu klimatyzacji. Konstrukcja skraplacza, jako wymiennika ciepła, jest podobna do konstrukcji chłodnicy, lecz musi on wytrzymywać wysokie ciśnienia wewnętrzne (do 34 bar), typowe dla układów klimatyzacji. Skraplacze DENSO, w szczególności nasze najnowsze rozwiązania, posiadają wbudowany osuszacz dla zapewnienia najwyższej sprawności układu klimatyzacji.

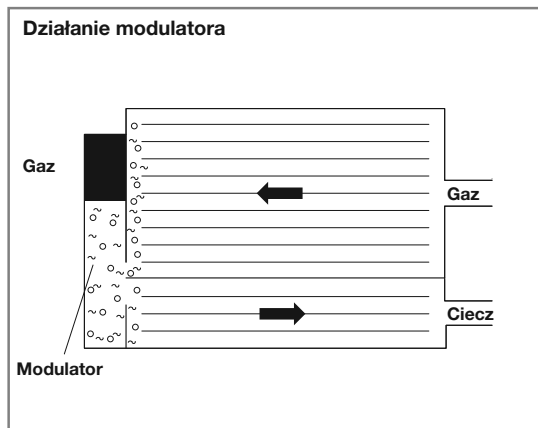
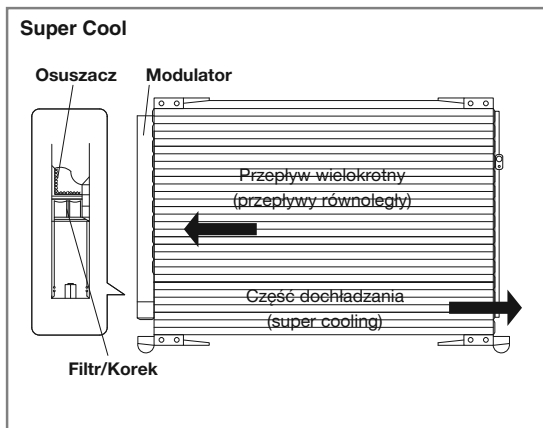
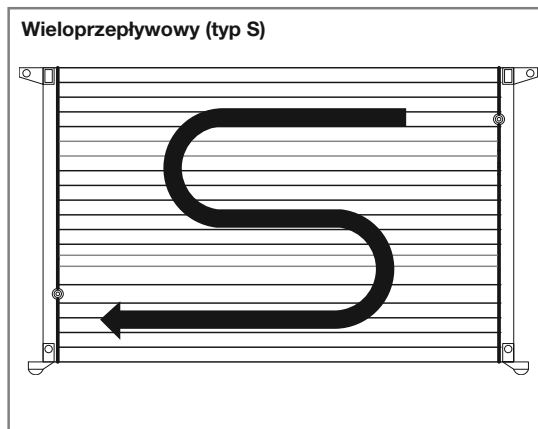
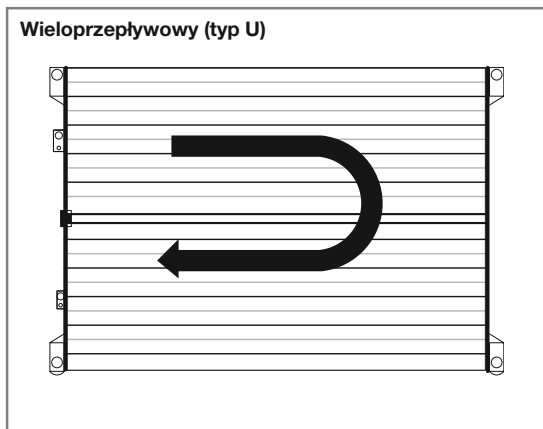
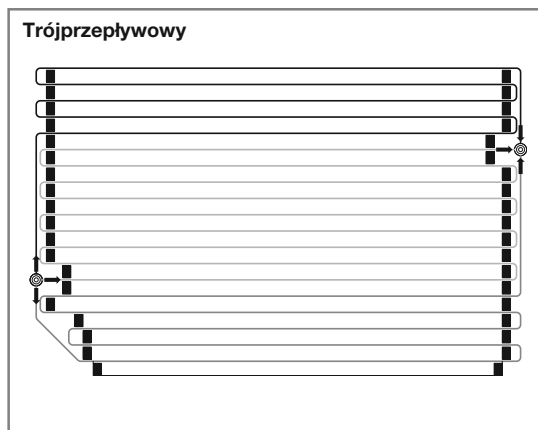
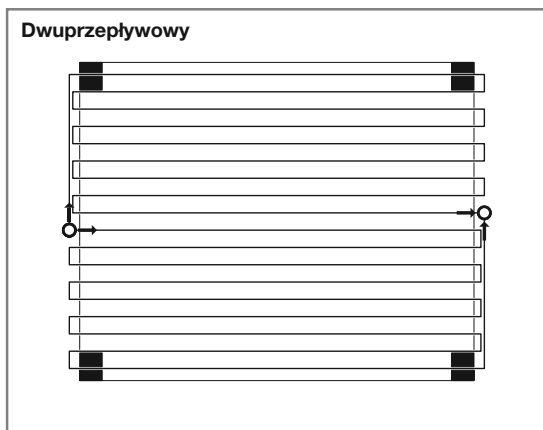

PL

## Sprężarka klimatyzacji

Bardzo dokładnie zapoznaj się z instrukcją montażu kompresora, zanim rozpoczniesz instalację nowej sprężarki DENSO. Instrukcję montażu znajdziesz w pudełku z nową sprężarką i / lub na naszej stronie internetowej.

<http://www.denso-am.pl>

## Olej do sprężarki



*Podczas wymiany sprężarki należy przestrzegać odpowiedniej procedury w celu określenia właściwej ilości oleju w układzie klimatyzacji. Sprawdź szczegóły w instrukcji montażu sprężarki. Zawsze upewnij się, że zastosowałeś odpowiedni olej. Szczegółowe informacje znajdują się na etykiecie sprężarki.*



### DENSO olej ND-8

DENSO olej ND-8 jest stosowany w sprężarkach tłokowych i rotacyjnych (spiralnych) z czynnikiem chłodniczym typu R134a.

Dostępny w puszcze o pojemności 250cm<sup>3</sup>: 997635-8250



### DENSO olej ND-9

DENSO olej ND-9 jest stosowany w sprężarkach łopatkowych z czynnikiem chłodniczym typu R134a.

Dostępny w puszcze o pojemności 250cm<sup>3</sup>: 446963-2040



### DENSO olej ND-11

DENSO olej ND-11 jest stosowany w sprężarkach spiralnych o napędzie elektrycznym z czynnikiem chłodniczym typu R134a lub R1234yf.

Dostępny w puszcze o pojemności 250cm<sup>3</sup>: 042198-0080



### DENSO olej ND-12

DENSO olej ND-12 jest stosowany w sprężarkach tłokowych i rotacyjnych (spiralnych) z czynnikiem chłodniczym typu R1234yf lub R134a.

Dostępny w puszcze o pojemności 250cm<sup>3</sup>: 446963-0300



## Отличие DENSO

Водители и пассажиры, садясь в автомобиль, рассчитывают, что во время движения им будет обеспечен максимальный комфорт в любую погоду. Именно поэтому мировые производители автомобилей выбирают DENSO, лидера в производстве оригинальной термической продукции, для поставок эффективных и надежных компонентов систем обогрева, вентиляции и кондиционирования воздуха.

Сохраняя за собой 42% доли рынка оригинального оборудования, DENSO является не только разработчиком передовых систем кондиционирования воздуха и охлаждения двигателя, но и мировым лидером в производстве компрессоров кондиционеров. Выдающиеся инженерные решения воплощаются в качественной продукции, доступной также и для рынка автозапчастей, обеспечивая тем самым эталонное качество и технологичность на международном уровне.

**Предлагая 100% ассортимент OE качества компрессоры кондиционеров DENSO обеспечивают абсолютную надежность, широкий охват автопарка и легкость поиска в каталогах TecDoc**

## Система кондиционирования воздуха

### Устройство системы

Основной задачей системы кондиционирования воздуха является поддержание комфортной для пассажиров температуры воздуха в салоне автомобиля путем охлаждения или нагрева воздуха, поступающего в салон. Для выполнения этой задачи система кондиционирования автомобиля включает в себя обогреватель, испаритель и систему вентиляции, состоящую из вентилятора обдува, воздуховодов и воздухоочистителя.

Основные части системы охлаждения:

- > Компрессор
- > Конденсатор
- > Резервуар-осушитель
- > Расширительный клапан
- > Испаритель

Компоненты системы связаны между собой посредством различных шлангов и трубок.

### Работа системы кондиционирования воздуха автомобиля

#### Компрессор DENSO

Двигатель обеспечивает работу компрессора через ремень и шкив или муфту сцепления. Хладагент в виде газа поступает в компрессор с низкой температурой и низким давлением из испарителя и сжимается до очень высокого давления, при этом интенсивно нагреваясь. Далее хладагент поступает в конденсатор.

#### Конденсатор DENSO

Конденсатор – это теплообменник, который забирает тепло у газообразного хладагента, поступающего из компрессора. Остывая, хладагент превращается в жидкость и далее стекает в ресивер-осушитель.

#### Резервуар-осушитель DENSO

Хладагент находится в ресивер-осушителе до окончательного перехода в жидкое состояние, откуда попадает в испаритель.

#### Расширительный клапан DENSO

Расширительный клапан обеспечивает поступление хладагента в испаритель, где жидкий хладагент высокого давления испаряется и переходит в состояние жидкость - пар с низкой температурой и давлением.

#### Испаритель DENSO

В испарителе хладагент переходит в газообразное состояние, при этом его температура и давление падает. Для испарения необходимо большое количество тепла, которое испаритель получает от теплого воздуха, проходящего через его поверхность, тем самым обеспечивая охлаждение воздуха в салоне автомобиля. Жидкий хладагент переходит в газообразное состояние и снова попадает в компрессор. Процесс затем повторяется.

#### Переключатель (датчик) давления DENSO

Переключатель давления (или датчик давления) – это устройство, защищающее систему охлаждения от слишком высокого или слишком низкого давления. Также датчик передает уровень давления на блок управления, который использует полученную информацию для последующего управления давлением при использовании компрессора с электронным управлением.

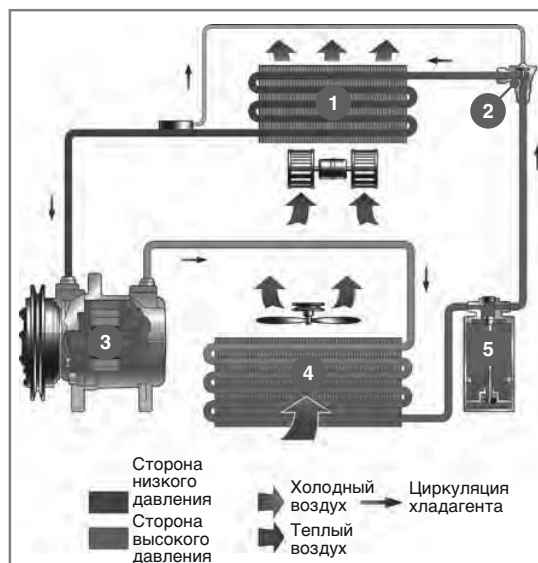

1. Испаритель
2. Расширительный клапан
3. Компрессор
4. Конденсатор
5. Резервуар-осушитель



RU

## Компрессоры



### Компрессор 10PA

- > Компрессор с двусторонним наклонным диском-толкателем (Swash Plate) с фиксированным рабочим объемом
- > 10 поршней
- > Известен надежностью, отсутствием шума и пульсации
- > Компрессорное масло: ND-8

### Компрессор 10S

- > Улучшенная модель 10PA
- > Основное различие – уменьшенный размер и вес
- > Сервис-клапан больше не используется; шланги напрямую подсоединены к корпусу компрессора
- > Компрессорное масло: ND-8

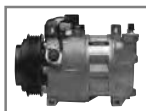

### Компрессор 6CA

- > Компрессор с односторонним качающимся диском с изменяемым рабочим объемом (Wobble Plate)
- > 6 поршней, переменный рабочий объем
- > Компрессорное масло: ND-8



### Компрессор 7SB(U)

- > Компрессор с односторонним наклонным диском (Swash Plate)
- > 7 поршней, переменный рабочий объем от 3 до 100%
- > Внешнее (электронное) или внутреннее (механическое) управление переменным рабочим объемом
- > Компрессорное масло: ND-8



### Компрессор типа ES

- > Спиральный компрессор с электрическим приводом и регулируемым рабочим объемом
- > Надежное уплотнение снижает утечку хладагента
- > Система кондиционирования работает даже при выключенном двигателе
- > Камера компрессора состоит из двух спиралей: фиксированной и вращающейся
- > Компрессорное масло: ND-11, диэлектрическое масло (непроводящее масло)

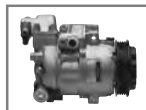

### Компрессор SE / SL

- > Компрессор с односторонним наклонным диском (Swash Plate)
- > 5, 6 или 7 поршней в зависимости от модели
- > Внешнее (электронное) управление переменным рабочим объемом от 2% до 100%
- > В компрессоре типа SE отсутствует электромагнитная муфта и он постоянно работает
- > Компрессорное масло: ND-8

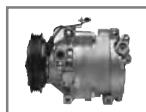

### Компрессор спирального типа (SC)

- > В камеру компрессора входит пара спиралеобразных винтов: один зафиксирован и один вращается
- > Известен низкими шумовыми качествами и высокими показателями
- > Компрессорное масло: ND-8



### Роторно-пластинчатый компрессор (TV)

- > В камере компрессора находится ротор и две пластины, движущиеся вдоль ротора
- > Два разных типа рабочего объема: 120 или 140 см<sup>3</sup>
- > Компрессорное масло: ND-9



**RU**

## Конденсаторы

Конденсатор – это теплообменник системы кондиционирования воздуха автомобиля. Его задачей является сжижение хладагента в цикле кондиционирования воздуха. Являясь теплообменником, конденсатор по своей структуре похож на нагреватель, но рассчитан на высокое внутреннее давление (до 34 бар), типичное для систем кондиционирования воздуха. Конденсаторы DENSO, в особенности последние модели, обладают встроенным фильтром/осушителем, обеспечивающим более эффективную работу системы кондиционирования воздуха.

**Двойная циркуляция**

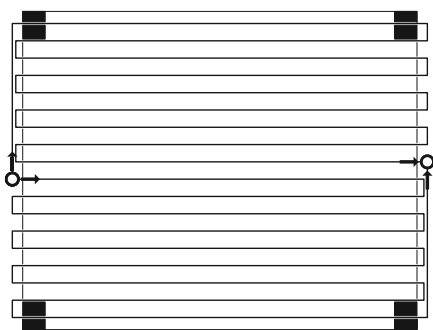

**Тройная циркуляция**



**Множественная циркуляция (U-образные потоки воздуха)**

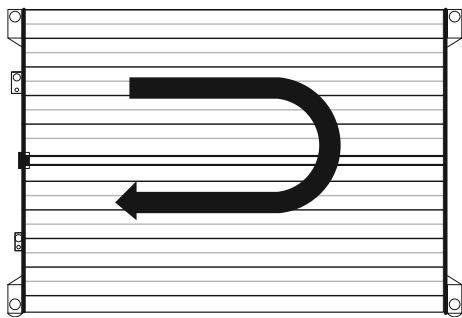

**Множественная циркуляция (S-образные потоки воздуха)**

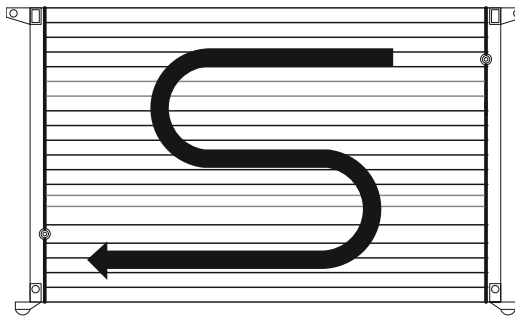

**Супер-охлаждение**

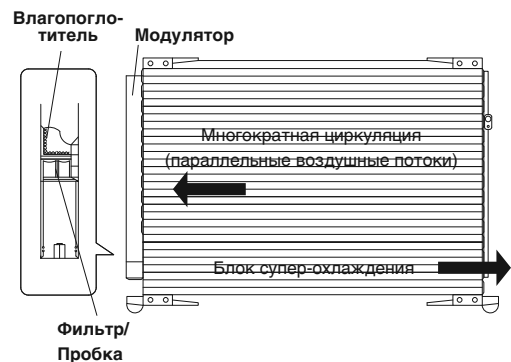

**Функция модулятора**

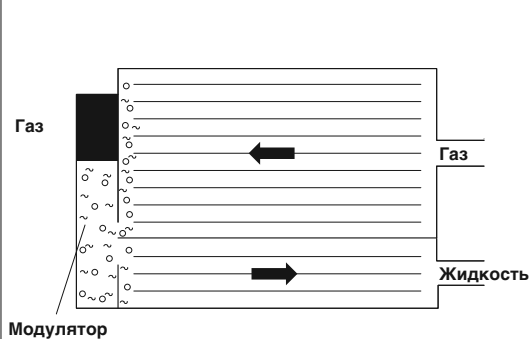

**RU**

### Компрессор

Перед началом установки нового компрессора DENSO на автомобиль внимательно ознакомьтесь с инструкцией. Инструкция по установке находится в коробке с компрессором, а также размещена на сайте.

<http://www.denso-am.ru/>

### Компрессорное масло



*При замене компрессора необходимо соблюдать определенную последовательность действий для определения требуемого количества масла в системе кондиционирования. Подробная процедура описана в инструкции по установке. Убедитесь, что Вы используете подходящее масло. Требуемый тип масла указан на этикетке на корпусе компрессора.*



#### DENSO ND-8

Масло DENSO ND-8 используется в поршневых компрессорах и роторных (спиральных) компрессорах с хладагентом типа R134a.

Артикул DENSO для упаковки 250 см<sup>3</sup>: 997635-8250



#### DENSO ND-9

Масло DENSO ND-9 используется для лопастных компрессоров с хладагентом R134a.

Артикул DENSO для упаковки 250 см<sup>3</sup>: 446963-2040



#### DENSO ND-11

Масло DENSO ND-11 используется в винтовых электрических компрессорах с хладагентами R134a или R1234yf.

Артикул DENSO для упаковки 250 см<sup>3</sup>: 042198-0080



#### DENSO ND-12

Масло DENSO ND-12 используется в поршневых компрессорах и роторных (спиральных) компрессорах с хладагентом типа R1234yf или R134a.

Артикул DENSO для упаковки 250 см<sup>3</sup>: 446963-0300







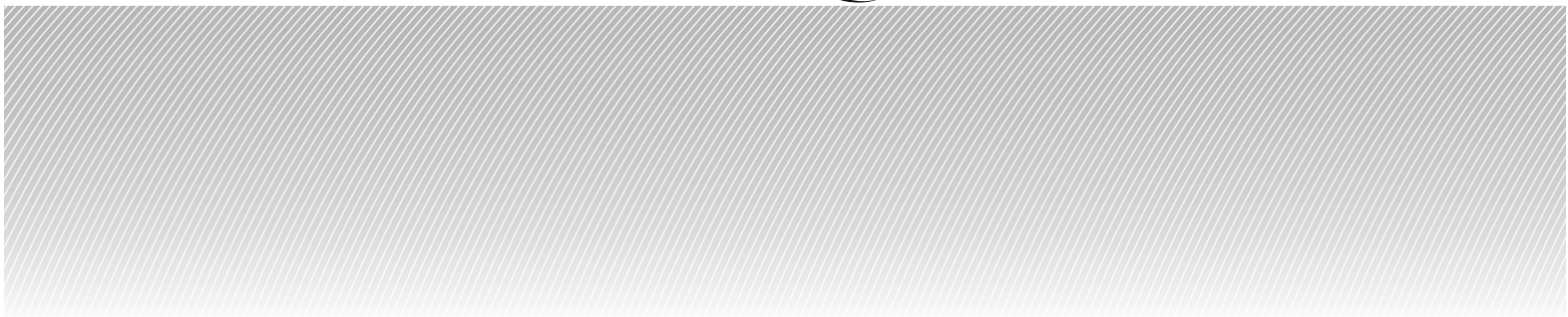
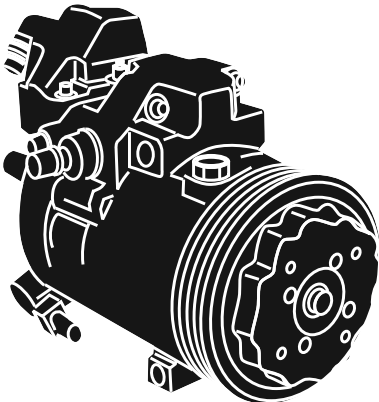

# DENSO Compressors



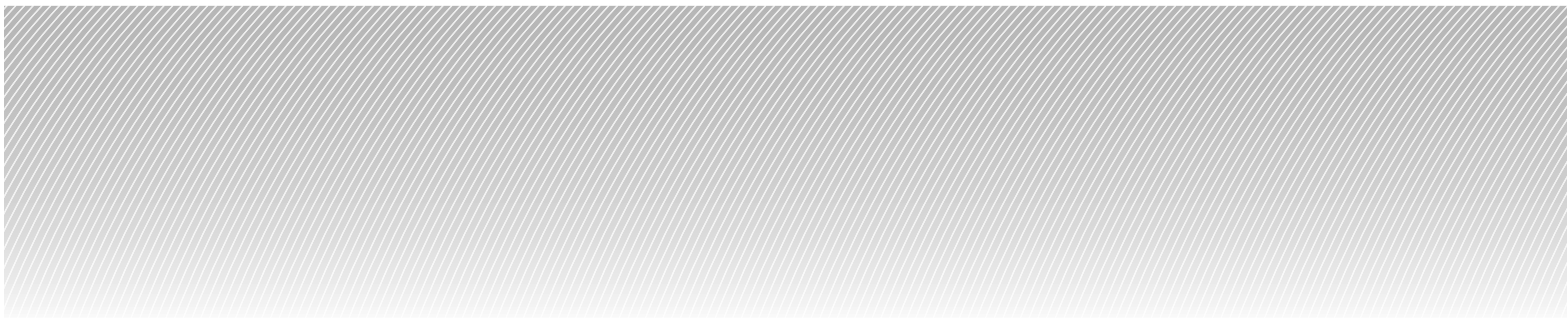









# DENSO Application Tables – Compressors



				TYPE	GAS	DENSO PN	OE
<b>ABARTH</b>							
<b>500 / 595 (C) (312) (07-)</b>							
1.4	312 A1.000;312 A3.000;312 A9.000			05/08-08/16	SCSB06C	R134a	DCP09004
1.4	312 A1.000;312 A3.000;312 A9.000; 312 B3.000;312 B4.000;312 B6.000			05/08-	SCSB06C	R134a; R1234yf	DCP09061
<b>Grande PUNTO (05-12)</b>							
1.4	199 A8.000			12/07-06/10	5SL12C	R134a	DCP09020
1.4	199 A8.000;955 A8.000			12/07-12/12	5SL12	R134a; R1234yf	DCP09063
<b>PUNTO Evo (08-12)</b>							
1.4	199 A8.000;955 A8.000			03/12-02/12	5SL12C	R134a	DCP09020
1.4	199 A8.000;955 A8.000			03/12-02/12	5SL12	R134a; R1234yf	DCP09063
<b>ALFA ROMEO</b>							
<b>145 / 146 (94-01)</b>							
1.4 i.e.	AR 33501			05/95-12/96	TV12SC	R134a	DCP09009
1.4 i.e. 16V T.Spark	AR 33503			11/96-02/98	TV12SC	R134a	DCP09009
1.4 i.e. 16V T.Spark	AR 33503			11/96-02/99	7SBU16C	R134a	DCP01001
1.4 i.e. 16V T.Spark	AR 33503			11/96-02/99	SCS08C	R134a	DCP09001
1.4 i.e. 16V T.Spark	AR 33503	Ch No: >3174687		12/96-01/01	TV12SC	R134a	DCP09009
1.4 i.e. 16V T.Spark	AR 33503	Ch No: 1391187>		12/96-02/99	SCS08C	R134a	DCP09001
1.6 i.e.	AR 33201			05/95-12/96	TV12SC	R134a	DCP09009
1.6 i.e. 16V T.Spark	AR 67601			11/96-10/01	TV12SC	R134a	DCP09009
1.8 i.e. 16V	AR 32201			03/98-06/99	7SBU16C	R134a	DCP01001
1.8 i.e. 16V	AR 32201			03/98-01/01	TV12SC	R134a	DCP09009
1.8 i.e. 16V T.Spark	AR 32201			03/98-06/99	7SBU16C	R134a	DCP01001
1.8 i.e. 16V T.Spark	AR 32201;AR 67106;AR 67199			11/96-01/01	TV12SC	R134a	DCP09009
1.9 JTD	AR 32302			02/99-01/01	7SBU16C	R134a	DCP01001
1.9 TD	AR 33601			06/98-02/99	7SBU16C	R134a	DCP01001
1.9 TD	AR 33601			06/98-02/99	TV12SC	R134a	DCP09009
2.0 16V	AR 32301			03/97-06/99	7SBU16C	R134a	DCP01001
2.0 16V	AR 32301			03/97-10/01	TV12SC	R134a	DCP09009
<b>147 (00-10)</b>							
1.9 JTD 16V	192 A5.000;192 B1.000			10/04-01/10	5SL12C-J	R134a	DCP09008
1.9 JTD 8V	182 B9.000;937 A2.000			06/05-09/05	5SL12C-J	R134a	DCP09008
1.9 JTDM 16V	937 A5.000;937 A6.000			09/04-01/10	5SL12C-J	R134a	DCP09008
1.9 JTDM 8V	937 A3.000;939 A7.000			10/04-01/10	5SL12C-J	R134a	DCP09008
<b>155 (92-97)</b>							
1.6 16V T.Spark	AR 67601			05/96-08/97	TV12SC	R134a	DCP09009
1.7 T.Spark	AR 67106			05/96-08/97	TV12SC	R134a	DCP09009
1.8 T.Spark	AR 67402			02/92-03/95	TV12SC	R134a	DCP09009
1.8 T.Spark	AR 67101;AR 67102			02/92-12/96	TV12SC	R134a	DCP09009
<b>156 (97-06)</b>							
1.6 16V T.Spark	AR 32104; AR 67601			05/00-05/06	7SBU16C	R134a	DCP01001
1.8 16V T.Spark	AR 32201;AR 32205			02/97-05/06	7SBU16C	R134a	DCP01001
1.9 JTD	192 B1.000;937 A2.000;AR 32302; AR 37101			06/98-05/06	7SBU16C	R134a	DCP01001
1.9 JTD	937 A2.000;937 A4.000;937 A5.000			06/05-05/06	5SL12C-J	R134a	DCP09008
1.9 JTD 16V	192 A5.000			11/02-11/04	7SBU16C	R134a	DCP01001
1.9 JTD 16V Q4	937 A5.000			06/05-05/06	5SL12C-J	R134a	DCP09008
2.0 16V T.Spark	AR 32301;AR 32310			06/98-06/02	7SBU16C	R134a	DCP01001
2.0 JTS	937 A1.000			03/02-09/05	7SBU16C	R134a	DCP01001
2.4 JTD	839 A6.000;841 C000;841 G.000; 841 M.000;AR 32501			05/00-05/06	7SBU16C	R134a	DCP01001
2.4 JTD	AR 32501	Ch No: 1904013>		09/97-09/03	7SBU16C	R134a	DCP01001
2.5 V6 24V	AR 32401;AR 32405			02/97-05/06	7SBU16C	R134a	DCP01001
3.2 GTA	932 A.000			03/02-05/06	7SBU16C	R134a	DCP01001
<b>166 (98-07)</b>							
2.0 T.Spark	AR 34103;AR 36301			09/98-06/07	7SBU16C	R134a	DCP01001
2.0 V6	AR 34102			09/98-10/00	7SBU16C	R134a	DCP01001
2.4 JTD	839 A6.000;841 C000;841 G.000; 841 H.000;841 M.000;841 N.000; 936 B.000;AR 34202			09/98-06/07	7SBU16C	R134a	DCP01001
2.5 V6 24V	AR 34201;AR 36201			09/98-06/07	7SBU16C	R134a	DCP01001
3.0 V6 24V	AR 34301;AR 36101			09/98-06/07	7SBU16C	R134a	DCP01001
3.2 V6 24V	936 A.000			10/03-06/07	7SBU16C	R134a	DCP01001
<b>GT (03-10)</b>							
1.9 JTD	937 A5.000;937 A6.000			07/06-01/10	5SL12C-J	R134a	DCP09008
<b>MITO (08-)</b>							
0.9 TwinAir	199 B6.000;312 A2.000			07/11-05/16	5SEL12	R134a	DCP09034



				TYPE	GAS	DENSO PN	OE
<b>ALFA ROMEO</b> <i>Continued</i>							
<b>MITO (08-)</b> <i>Continued</i>							
0.9 TwinAir	199 B6.000;312 A2.000			07/11-	5SL12	R134a; R1234yf	DCP09064 50541346
0.9 TwinAir	312 A2.000			07/11-09/13	5SL12C	R134a	DCP09032 51906240
1.3 D Multijet	199 A3.000;199 B1.000;199 B4.000; 199 B8.000;330 A1.000;955 B2.000			08/08-	-	R134a	DCP09K22
1.4	199 A6.000;350 A1.000;955 A1.000; 955 A9.000			08/08-05/16	5SL12C	R134a	DCP09016
1.4	199 A6.000;350 A1.000;955 A1.000; 955 A9.000			08/08-	5SL12	R134a; R1234yf	DCP09062 50541342
1.4 BiFuel	198 A4.000			01/09-07/16	5SL12C	R134a	DCP09020
1.4 BiFuel	198 A4.000			01/09-	5SL12	R134a; R1234yf	DCP09063
1.4 MultiAir	940 A2.000;955 A2.000;955 A7.000; 955 A8.000			09/09-	5SL12	R134a; R1234yf	DCP09063 50541343
1.4 MultiAir	940 A2.000;955 A2.000;955 A8.000			09/09-05/16	5SL12C	R134a	DCP09020 51794515
1.4 MultiAir	955 A6.000			09/09-08/13	5SL12	R134a; R1234yf	DCP09062 50541342
1.4 MultiAir	955 A6.000			09/09-05/16	5SL12C	R134a	DCP09016
1.4 TB	955 B1.000			12/13-05/16	5SL12C	R134a	DCP09020 51794515
1.4 TB	955 B1.000			12/13-	5SL12	R134a; R1234yf	DCP09063 50541343
1.4 TJet	198 A1.000;198 A4.000;199 A8.000			08/08-05/16	5SL12C	R134a	DCP09020 51794515
1.4 TJet	198 A1.000;198 A4.000;199 A8.000			08/08-	5SL12	R134a; R1234yf	DCP09063 50541343
<b>ASTON MARTIN</b>							
<b>DB9 (04-16)</b>							
6.0	AM3			04/04-06/06	5SA12C	R134a	DCP11008 4G43-19D629-AA
6.0 V12	AM3			07/04-06/06	5SA12C	R134a	DCP11008 4G43-19D629-AA
<b>AUDI</b>							
<b>80 (81, 85, B2) (78-86)</b>							
1.8 CC quattro	JN;JV;NE			08/84-08/86	10P17C	R12 (Retrofit to R134a necessary!)	DCP02001
1.8 GTE quattro	DZ;PV			08/84-08/86	10P17C	R12 (Retrofit to R134a necessary!)	DCP02001
<b>80 (89, 8A, B3) (86-91)</b>							
1.4	SE			04/87-07/88	10P17C	R12 (Retrofit to R134a necessary!)	DCP02001
1.6	ABB;PP;RN			09/86-10/91	10P17C	R12 (Retrofit to R134a necessary!)	DCP02001
1.6 D	JK			04/87-07/89	10P17C	R12 (Retrofit to R134a necessary!)	DCP02001
1.6 TD	RA; SB			09/86-08/91	10P17C	R12 (Retrofit to R134a necessary!)	DCP02001
1.8	RU			10/86-01/90	10P17C	R12 (Retrofit to R134a necessary!)	DCP02001
1.8	SD			04/87-07/88	10P17C	R12 (Retrofit to R134a necessary!)	DCP02001
1.8 E	DZ			04/87-08/91	10P17C	R12 (Retrofit to R134a necessary!)	DCP02001
1.8 E quattro	DZ			09/86-08/91	10P17C	R12 (Retrofit to R134a necessary!)	DCP02002





				TYPE	GAS	DENSO PN	OE
<b>AUDI</b> <i>Continued</i>							
<b>80 (89, 8A, B3) (86-91)</b> <i>Continued</i>							
1.8 quattro	SD		09/86-07/88	10P17C	R12 (Retrofit to R134a necessary!)	DCP02002	
1.8 S	JN;JV;NE;PM;SF		08/86-10/91	10P17C	R12 (Retrofit to R134a necessary!)	DCP02001	
1.8 S quattro	NE;PM;SF		09/86-09/91	10P17C	R12 (Retrofit to R134a necessary!)	DCP02002	
1.9 D	1Y		08/89-12/90	10P17C	R12 (Retrofit to R134a necessary!)	DCP02001	
2.0	AAD		10/90-08/91	10P17C	R12 (Retrofit to R134a necessary!)	DCP02001	
2.0 E	3A		08/88-10/90	10P17C	R12 (Retrofit to R134a necessary!)	DCP02001	
2.0 E 16V	6A		03/90-09/91	10P17C	R12 (Retrofit to R134a necessary!)	DCP02001	
2.0 E 16V quattro	6A		03/90-08/91	10P17C	R12 (Retrofit to R134a necessary!)	DCP02002	
2.0 E quattro	3A		08/88-09/90	10P17C	R12 (Retrofit to R134a necessary!)	DCP02002	
2.0 quattro	AAD		10/90-08/91	10P17C	R12 (Retrofit to R134a necessary!)	DCP02002	
<b>80 (8C, B4) (91-96)</b>							
1.6	ABM		01/92-12/94	10P17C	R12 (Retrofit to R134a necessary!)	DCP02001	
1.6 E	ADA		06/93-07/95	10P17C	R12 (Retrofit to R134a necessary!)	DCP02001	
2.0	ABT		09/91-06/95	10P17C	R12 (Retrofit to R134a necessary!)	DCP02001	
2.0 E	ABK		09/91-07/95	10P17C	R12 (Retrofit to R134a necessary!)	DCP02001	
2.0 E 16V	6A;ACE		09/91-07/95	10P17C	R12 (Retrofit to R134a necessary!)	DCP02001	
2.3 E	NG		09/91-06/95	10P17C	R12 (Retrofit to R134a necessary!)	DCP02001	
2.6	ABC		07/92-07/95	10P17C	R12 (Retrofit to R134a necessary!)	DCP02001	





				TYPE	GAS	DENSO PN	OE
<b>AUDI</b> <i>Continued</i>							
<b>80 (8C, B4) (91-96)</b> <i>Continued</i>							
2.8	AAH;AFC		09/91-07/95	10P17C	R12 (Retrofit to R134a necessary)	DCP02001	
<b>90 (81, 85, B2) (84-87)</b>							
2.0	HP;SK		10/84-03/87	10P17C	R12 (Retrofit to R134a necessary)	DCP02001	034260805D
2.0 quattro	JS		08/84-08/86	10P17C	R12 (Retrofit to R134a necessary)	DCP02001	
2.2	HY;KV		10/84-07/86	10P17C	R12 (Retrofit to R134a necessary)	DCP02001	
2.2 E quattro	JT;KV		11/84-03/87	10P17C	R12 (Retrofit to R134a necessary)	DCP02001	
<b>90 (89, 8A, B3) (87-91)</b>							
1.6 TD	RA; SB		04/88-12/90	10P17C	R12 (Retrofit to R134a necessary)	DCP02001	
2.0	PS		07/88-09/91	10P17C	R12 (Retrofit to R134a necessary)	DCP02001	
2.0 20 V	NM		08/89-07/91	10P17C	R12 (Retrofit to R134a necessary)	DCP02001	
2.0 20 V quattro	NM		08/88-09/91	10P17C	R12 (Retrofit to R134a necessary)	DCP02001	
2.2 E	KV		04/87-07/91	10P17C	R12 (Retrofit to R134a necessary)	DCP02001	
2.2 E quattro	KV		04/87-09/91	10P17C	R12 (Retrofit to R134a necessary)	DCP02001	
2.3 E	NG		04/87-09/91	10P17C	R12 (Retrofit to R134a necessary)	DCP02001	
2.3 E 20V	7A		08/88-07/91	10P17C	R12 (Retrofit to R134a necessary)	DCP02001	
2.3 E 20V quattro	7A		06/88-09/91	10P17C	R12 (Retrofit to R134a necessary)	DCP02001	
2.3 E quattro	NG		04/87-09/91	10P17C	R12 (Retrofit to R134a necessary)	DCP02001	
<b>100 (44, C3) (82-91)</b>							
1.8	DR	Ch No: 44-G-130001>	08/82-10/86	10P17C	R12 (Retrofit to R134a necessary)	DCP02002	034260805C
1.8	DR;DS;JW;NP;RS;SH		08/82-07/90	10P17C	R12 (Retrofit to R134a necessary)	DCP02001	034260805D

				TYPE	GAS	DENSO PN	OE
<i>AUDI Continued</i>							
<b>100 (44, C3) (82-91) Continued</b>							
1.8	SH		02/86-12/87	10P17C	R12 (Retrofit to R134a necessary!)	DCP02002	034260805C
1.8 Cat	4B;PH		03/85-11/90	10P17C	R12 (Retrofit to R134a necessary!)	DCP02001	
1.8 Cat quattro	4B;PH		08/85-06/86	10P17C	R12 (Retrofit to R134a necessary!)	DCP02001	034260805B
1.8 Cat quattro	4B;PH		07/86-11/90	10P17C	R12 (Retrofit to R134a necessary!)	DCP02002	034260805A
1.8 quattro	JW;NP;SH		10/84-07/88	10P17C	R12 (Retrofit to R134a necessary!)	DCP02001	034260805D
1.8 quattro	JW;NP;SH		07/86-07/90	10P17C	R12 (Retrofit to R134a necessary!)	DCP02002	
1.8 quattro	SH	Ch No: 44-G-130001>	08/86-07/88	10P17C	R12 (Retrofit to R134a necessary!)	DCP02002	034260805C
2.0	KP		08/84-12/87	10P17C	R12 (Retrofit to R134a necessary!)	DCP02001	
2.0	SL		08/86-11/87	10P17C	R12 (Retrofit to R134a necessary!)	DCP02002	034260805C
2.0	SL	Ch No: 44G053401>44G160000	08/86-11/87	10P17C	R12 (Retrofit to R134a necessary!)	DCP02001	034260805D
2.0 Cat	RT		01/88-11/90	10P17C	R12 (Retrofit to R134a necessary!)	DCP02001	
2.0 D	CN		08/82-11/90	10P17C	R12 (Retrofit to R134a necessary!)	DCP02002	034260805C
2.0 D	CN	Ch No: 44G053401>44G160000	08/82-11/90	10P17C	R12 (Retrofit to R134a necessary!)	DCP02001	034260805D
2.0 D Turbo	DE	Ch No: 44G053401>44G160000	08/82-02/88	10P17C	R12 (Retrofit to R134a necessary!)	DCP02001	034260805D
2.0 D Turbo	DE;NC		08/82-11/90	10P17C	R12 (Retrofit to R134a necessary!)	DCP02002	034260805C
2.0 E	KP		01/85-12/87	10P17C	R12 (Retrofit to R134a necessary!)	DCP02001	
2.0 E Cat	RT		01/88-11/90	10P17C	R12 (Retrofit to R134a necessary!)	DCP02001	
2.0 TD	DE	Ch No: 44G053401>44G160000	03/83-10/87	10P17C	R12 (Retrofit to R134a necessary!)	DCP02001	034260805D





				TYPE	GAS	DENSO PN	OE
<b>AUDI</b> <i>Continued</i>							
<b>100 (44, C3) (82-91)</b> <i>Continued</i>							
2.0 TD	DE;NC		03/83-11/90	10P17C	R12 (Retrofit to R134a necessary)	DCP02002	034260805C
2.1	WC		08/82-07/84	10P17C	R12 (Retrofit to R134a necessary)	DCP02002	
2.2	KF		08/82-07/84	10P17C	R12 (Retrofit to R134a necessary)	DCP02002	034260805C
2.2	KF	Ch No: 44G053401>44G160000	08/82-07/84	10P17C	R12 (Retrofit to R134a necessary)	DCP02001	034260805D
2.2	KU;KZ		08/84-12/88	10P17C	R12 (Retrofit to R134a necessary)	DCP02002	
2.2 Cat	HX;KU		06/89-11/90	10P17C	R12 (Retrofit to R134a necessary)	DCP02002	
2.2 Cat quattro	HX;KU		06/89-11/90	10P17C	R12 (Retrofit to R134a necessary)	DCP02002	
2.2 E quattro	PX		08/85-07/86	10P17C	R12 (Retrofit to R134a necessary)	DCP02001	
2.2 E Turbo quattro	MC		08/86-11/90	10P17C	R12 (Retrofit to R134a necessary)	DCP02002	
2.2 quattro	KU		08/84-06/86	10P17C	R12 (Retrofit to R134a necessary)	DCP02001	034260805B
2.2 quattro	KU		07/86-12/88	10P17C	R12 (Retrofit to R134a necessary)	DCP02002	034260805A
2.2 Turbo	MC		08/86-11/90	10P17C	R12 (Retrofit to R134a necessary)	DCP02002	
2.2 Turbo quattro	MC		08/86-11/90	10P17C	R12 (Retrofit to R134a necessary)	DCP02002	
2.3	NF		08/86-11/90	10P17C	R12 (Retrofit to R134a necessary)	DCP02002	
2.3 E	NF		10/86-11/90	10P17C	R12 (Retrofit to R134a necessary)	DCP02002	
2.3 E quattro	NF		08/86-11/90	10P17C	R12 (Retrofit to R134a necessary)	DCP02002	
2.3 quattro	NF		01/90-11/90	10P17C	R12 (Retrofit to R134a necessary)	DCP02002	034260805A
2.4 D	3D		08/89-11/90	10P17C	R12 (Retrofit to R134a necessary)	DCP02002	





				TYPE	GAS	DENSO PN	OE
<b>AUDI</b> <i>Continued</i>							
<b>100 (44, C3) (82-91)</b> <i>Continued</i>							
2.5 TDI	1T		01/90-11/90	10P17C	R12 (Retrofit to R134a necessary!)	DCP02002	
<b>100 (4A, C4) (90-94)</b>							
2.0	AAE		08/91-07/94	10P17C	R12 (Retrofit to R134a necessary!)	DCP02002	
2.0 E	AAD;AAE;ABK		08/91-07/94	10P17C	R12 (Retrofit to R134a necessary!)	DCP02002	
2.0 E 16V quattro	ACE		07/92-07/94	10P17C	R12 (Retrofit to R134a necessary!)	DCP02001	
2.0 E quattro	AAD		08/91-07/92	10P17C	R12 (Retrofit to R134a necessary!)	DCP02002	
2.2 S4 Turbo quattro	AAN		08/91-07/94	10P17C	R12 (Retrofit to R134a necessary!)	DCP02002	
2.3 E	AAR		12/90-07/94	10P17C	R12 (Retrofit to R134a necessary!)	DCP02002	
2.3 E quattro	AAR		08/91-07/94	10P17C	R12 (Retrofit to R134a necessary!)	DCP02002	
2.6 quattro	ABC		04/92-07/94	10P17C	R12 (Retrofit to R134a necessary!)	DCP02002	
2.8 E quattro	AAH		12/90-07/94	10P17C	R12 (Retrofit to R134a necessary!)	DCP02002	
4.2 S4 V8 quattro	ABH		10/92-07/94	10P17C	R12 (Retrofit to R134a necessary!)	DCP02002	
<b>200 (44) (83-91)</b>							
2.1 5E	WC		08/83-07/84	10P17C	R12 (Retrofit to R134a necessary!)	DCP02002	
2.1 Turbo	KG		08/83-01/88	10P17C	R12 (Retrofit to R134a necessary!)	DCP02002	
2.1 Turbo quattro	JY;KG		08/83-01/88	10P17C	R12 (Retrofit to R134a necessary!)	DCP02002	
2.2	KU		08/84-07/85	10P17C	R12 (Retrofit to R134a necessary!)	DCP02002	
2.2 20V Turbo quattro	3B		03/89-12/90	10P17C	R12 (Retrofit to R134a necessary!)	DCP02002	
2.2 Turbo	1B;2B;MC		08/85-12/90	10P17C	R12 (Retrofit to R134a necessary!)	DCP02002	





				TYPE	GAS	DENSO PN	OE
<b>AUDI</b> <i>Continued</i>							
<b>200 (44) (83-91)</b> <i>Continued</i>							
2.2 Turbo quattro	1B;MC		09/83-12/90	10P17C	R12 (Retrofit to R134a necessarily)	DCP02002	
2.3	NF		08/88-12/90	10P17C	R12 (Retrofit to R134a necessarily)	DCP02002	034260805C
<b>A1 (8X) (10-18)</b>							
1.0 TFSI	CHZB;CHZE;DKLD		03/15-10/18	6SES14C	R134a	DCP32060	
1.0 TFSI	CHZB;CHZE;DKLD		03/15-10/18	6SES14C	R134a; R1234yf	DCP32080	
1.2 TFSI	CBZA		05/10-04/15	6SEU14C	R134a	DCP02050	
1.4 TDI	CUSB		11/14-10/18	6SES14C	R134a	DCP32060	
1.4 TDI	CUSB		11/14-10/18	6SES14C	R134a; R1234yf	DCP32080	
1.4 TFSI	CAVG;CAXA;CNVA		05/10-04/15	6SEU14C	R134a	DCP02030	
1.4 TFSI	CPTA		04/12-04/15	6SEU14C	R134a	DCP02050	
1.4 TFSI	CZCA;CZDD		11/14-10/18	6SES14C	R134a	DCP32060	
1.4 TFSI	CZCA;CZDD		11/14-10/18	6SES14C	R134a; R1234yf	DCP32080	
1.4 TSI	CZEA		11/14-10/18	6SES14C	R134a	DCP32060	
1.4 TSI	CZEA		11/14-10/18	6SES14C	R134a; R1234yf	DCP32080	
1.6 TDI	CAYB;CAYC		05/10-04/15	6SEU14C	R134a	DCP02050	
1.6 TDI	CXMA		11/14-10/18	6SES14C	R134a	DCP32060	
1.6 TDI	CXMA		11/14-10/18	6SES14C	R134a; R1234yf	DCP32080	
1.8 TFSI	DAJB		02/15-10/18	6SES14C	R134a	DCP32060	
1.8 TFSI	DAJB		02/15-10/18	6SES14C	R134a; R1234yf	DCP32080	
2.0 S1 quattro	CWZA		03/14-10/18	6SES14C	R134a	DCP32060	
2.0 S1 quattro	CWZA		03/14-10/18	6SES14C	R134a; R1234yf	DCP32080	
2.0 TDI	CFHB;CFHD		09/11-04/15	6SEU14C	R134a	DCP02050	
2.0 TFSI quattro	CDLH		03/12-11/12	6SEU14C	R134a	DCP02030	
<b>A2 (8Z) (00-05)</b>							
1.2 TDI	ANY		03/01-08/05	6SEU12C	R134a	DCP02007	
1.4	AUA; BBY		06/00-08/05	6SEU12C	R134a	DCP02007	
1.4 TDI	AMF;ATL;BHC		06/00-08/05	6SEU12C	R134a	DCP02007	
1.6 FSI	BAD		05/02-08/05	6SEU12C	R134a	DCP02007	
<b>A3 (8L) (96-03)</b>							
1.9 TDI	ASZ;ATD;AXR		02/02-05/03	7SEU16C	R134a	DCP32003	
1.9 TDI	ASZ;ATD;AXR	All Climate zones	08/00-05/03	7SEU17C	R134a	DCP32002	
1.9 TDI quattro	ASZ		02/02-05/03	7SEU16C	R134a	DCP32003	
1.9 TDI quattro	ASZ	All Climate zones	08/00-05/03	7SEU17C	R134a	DCP32002	
<b>A3 (8P) (03-13)</b>							
1.2 TSI	CBZB	For cold climates;For mild climate zones	04/10-03/13	6SEU14C	R134a	DCP02030	
1.2 TSI	CBZB	For hot climate zones	04/10-03/13	7SEU17C	R134a	DCP32045	
1.4 TFSI	CAXC	For cold climates;For mild climate zones	09/07-03/13	6SEU14C	R134a	DCP02050	
1.4 TFSI	CAXC	For cold climates;For mild climate zones	07/08-03/13	6SEU14C	R134a	DCP02030	
1.4 TFSI	CAXC	For hot climate zones	09/07-03/13	7SEU17C	R134a	DCP32045	
1.6	BGU		05/03-05/05	7SEU16C	R134a	DCP32003	1K0820803A
1.6	BGU;BSE;BSF	All Climate zones	05/03-03/13	7SEU17C	R134a	DCP32002	
1.6	BGU;BSE;BSF	For cold climates;For mild climate zones	06/05-03/13	6SEU14C	R134a	DCP02050	
1.6	BGU;BSE;BSF	For cold climates;For mild climate zones	07/08-03/13	6SEU14C	R134a	DCP02030	





				TYPE	GAS	DENSO PN	OE
<i>AUDI Continued</i>							
<i>A3 (8P) (03-13) Continued</i>							
1.6	BGU;BSE;BSF	For hot climate zones	05/03-03/13	7SEU17C	R134a	DCP32045	
1.6 E-Power	CCSA;CMXA	For cold climates;For mild climate zones	01/11-03/13	6SEU14C	R134a	DCP02030	
1.6 E-Power	CCSA;CMXA	For hot climate zones	01/11-03/13	7SEU17C	R134a	DCP32045	
1.6 FSI	BAG;BLF;BLP	All Climate zones	08/03-09/07	7SEU17C	R134a	DCP32002	
1.6 FSI	BAG;BLF;BLP	For cold climates;For mild climate zones	01/05-09/07	6SEU14C	R134a	DCP02050	
1.6 FSI	BAG;BLF;BLP	For hot climate zones	08/03-09/07	7SEU17C	R134a	DCP32045	
1.6 FSI	BAG;BLP		08/03-12/04	7SEU16C	R134a	DCP32003	1K0820803A
1.6 TDI	CAYB;CAYC	For cold climates;For mild climate zones	05/09-03/13	6SEU14C	R134a	DCP02050	
1.6 TDI	CAYB;CAYC	For hot climate zones	05/09-03/13	7SEU17C	R134a	DCP32045	
1.8 TFSI	BYT;BZB;CDA	For cold climates;For mild climate zones	11/06-03/13	6SEU14C	R134a	DCP02050	
1.8 TFSI	BYT;BZB;CDA	For hot climate zones	11/06-03/13	7SEU17C	R134a	DCP32045	
1.8 TFSI quattro	CDA	For cold climates;For mild climate zones	07/08-03/13	6SEU14C	R134a	DCP02050	
1.8 TFSI quattro	CDA	For hot climate zones	07/08-03/13	7SEU17C	R134a	DCP32045	
1.9 TDI	BKC;BLS;BXE	For cold climates;For mild climate zones	05/03-05/10	6SEU14C	R134a	DCP02050	
1.9 TDI	BKC;BLS;BXE	For hot climate zones	05/03-05/10	7SEU17C	R134a	DCP32045	
2.0 FSI	AXW;BLR;BLX;BLY;BMB;BVY;BVZ		05/03-11/05	7SEU16C	R134a	DCP32003	1K0820803A
2.0 FSI	AXW;BLR;BLX;BLY;BMB;BVY;BVZ	All Climate zones	05/03-06/08	7SEU17C	R134a	DCP32002	
2.0 FSI	AXW;BLR;BLX;BLY;BMB;BVY;BVZ	For cold climates;For mild climate zones	09/04-06/08	6SEU14C	R134a	DCP02050	
2.0 FSI	AXW;BLR;BLX;BLY;BMB;BVY;BVZ	For hot climate zones	05/03-06/08	7SEU17C	R134a	DCP32045	
2.0 S3 quattro	BHZ;BZC;CDLA;CDLC		11/06-03/13	6SEU14C	R134a	DCP02050	
2.0 TDI	AZV;BKD;BMN;BUY;CBAB;CBBB;CFFB;CFGB;CLJA		09/04-06/08	7SEU17C	R134a	DCP32045	
2.0 TDI	AZV;BKD;BMN;CBAA;CBAB;CBBB;CFFA;CFFB;CFGB;CLJA	For cold climates;For mild climate zones	05/03-03/13	6SEU14C	R134a	DCP02050	
2.0 TDI	AZV;BKD;BMN;CBAA;CBAB;CBBB;CFFA;CFFB;CFGB;CLJA	For hot climate zones	05/03-03/13	7SEU17C	R134a	DCP32045	
2.0 TDI 8V	BMM		06/05-06/08	7SEU17C	R134a	DCP32045	
2.0 TDI 8V quattro	BMM		01/06-06/08	7SEU17C	R134a	DCP32045	
2.0 TDI quattro	BKD;BMN;CBAB;CBBB;CFFB;CFGB	For cold climates;For mild climate zones	08/04-03/13	6SEU14C	R134a	DCP02050	
2.0 TDI quattro	BKD;BMN;CBAB;CBBB;CFFB;CFGB	For hot climate zones	08/04-03/13	7SEU17C	R134a	DCP32045	
2.0 TDI quattro	BMN		03/06-06/08	7SEU17C	R134a	DCP32045	
2.0 TFSI	AXX		09/04-12/05	7SEU16C	R134a	DCP32003	1K0820803A
2.0 TFSI	AXX;BPY;BWA;CAWB;CBFA;CCTA;CCZA	All Climate zones	09/04-03/13	7SEU17C	R134a	DCP32002	
2.0 TFSI	AXX;BPY;BWA;CAWB;CBFA;CCTA;CCZA	For cold climates;For mild climate zones	09/04-03/13	6SEU14C	R134a	DCP02050	
2.0 TFSI	AXX;BPY;BWA;CAWB;CBFA;CCTA;CCZA	For hot climate zones	09/04-03/13	7SEU17C	R134a	DCP32045	
2.0 TFSI quattro	AXX		09/04-10/05	7SEU16C	R134a	DCP32003	1K0820803A
2.0 TFSI quattro	AXX;BPY;BWA;CCTA;CCZA	All Climate zones	09/04-03/13	7SEU17C	R134a	DCP32002	











				TYPE	GAS	DENSO PN	OE
<b>AUDI</b> <i>Continued</i>							
<b>A3 (8P) (03-13)</b> <i>Continued</i>							
2.0 TFSI quattro	AXX;BPY;BWA;CCTA;CCZA	For cold climates;For mild climate zones	09/05-03/13	6SEU14C	R134a	DCP02050	
2.0 TFSI quattro	AXX;BPY;BWA;CCTA;CCZA	For hot climate zones	09/04-03/13	7SEU17C	R134a	DCP32045	
3.2 V6 quattro	BDB		07/03-12/03	7SEU16C	R134a	DCP32003	1K0820803A
3.2 V6 quattro	BDB; BMJ; BUB	All Climate zones	07/03-05/09	7SEU17C	R134a	DCP32002	
3.2 V6 quattro	BDB;BMJ;BUB	For hot climate zones	07/03-05/09	7SEU17C	R134a	DCP32045	
3.2 V6 quattro	BDB;BUB	For cold climates;For mild climate zones	07/03-06/08	6SEU14C	R134a	DCP02050	
3.2 V6 quattro	BMJ	For cold climates;For mild climate zones	09/04-10/05	6SEU14C	R134a	DCP02030	
<b>A3 (8V) (12-)</b>							
1.0 TFSI	CHZD;DKRF		07/16-	6SES14C	R134a	DCP32060	
1.0 TFSI	CHZD;DKRF		07/16-	6SES14C	R134a; R1234yf	DCP32080	
1.2 TFSI	CJZA;CYVB		02/13-	6SES14C	R134a	DCP32060	
1.2 TFSI	CJZA;CYVB		02/13-	6SES14C	R134a; R1234yf	DCP32080	
1.4 TFSI	CMBA;CPTA;CXSA;CXSB;CZCA		04/12-	6SES14C	R134a	DCP32060	
1.4 TFSI	CMBA;CPTA;CXSA;CXSB;CZCA		04/12-	6SES14C	R134a; R1234yf	DCP32080	
1.4 TFSI e-tron	CUKB; CXUA		05/14-	6SES14C	R134a	DCP32060	
1.4 TFSI g-tron	CPWA		11/13-	6SES14C	R134a	DCP32060	
1.4 TFSI g-tron	CPWA		11/13-	6SES14C	R134a; R1234yf	DCP32080	
1.4 TSI	CZEA		05/14-	6SES14C	R134a	DCP32060	
1.4 TSI	CZEA		05/14-	6SES14C	R134a; R1234yf	DCP32080	
1.5 TFSI	DADA		05/17-	6SES14C	R134a; R1234yf	DCP32080	
1.6 TDI	CLHA;CRKB;CXXB;DBKA		10/12-	6SES14C	R134a	DCP32060	
1.6 TDI	CLHA;CRKB;CXXB;DBKA;DDYA		10/12-	6SES14C	R134a; R1234yf	DCP32080	
1.6 TDI quattro	CXXB		05/15-	6SES14C	R134a	DCP32060	
1.6 TDI quattro	CXXB		05/15-	6SES14C	R134a; R1234yf	DCP32080	
1.8 TFSI	CJSA;CJSB;CNSB		04/12-	6SES14C	R134a	DCP32060	
1.8 TFSI	CJSA;CJSB;CNSB		04/12-	6SES14C	R134a; R1234yf	DCP32080	
1.8 TFSI quattro	CJSB		08/12-	6SES14C	R134a	DCP32060	
1.8 TFSI quattro	CJSB		08/12-	6SES14C	R134a; R1234yf	DCP32080	
2.0 S3 quattro	CJXB;CJXC;CJXD;CJXF;CJXG;DJHA;DJHB;DNUÉ		11/12-	6SES14C	R134a; R1234yf	DCP32080	
2.0 S3 quattro	CJXB;CJXC;CJXF;DNUÉ		11/12-	6SES14C	R134a	DCP32060	
2.0 TDI	CRBC;CRBD;CRFA;CRFC;CRLB;CRLC;CRUA; CUNA;DBGA;DCYA;DEJA;DEJB;DFGA		04/12-	6SES14C	R134a	DCP32060	
2.0 TDI	CRBC;CRBD;CRFA;CRFC;CRLB;CRLC;CRUA; CUNA;DBGA;DCYA;DEJA;DEJB;DFGA		04/12-	6SES14C	R134a; R1234yf	DCP32080	
2.0 TDI quattro	CRBC;CRLB;CUNA;DCYA;DGCA		10/12-	6SES14C	R134a	DCP32060	
2.0 TDI quattro	CRBC;CRLB;CUNA;DCYA;DGCA		10/12-	6SES14C	R134a; R1234yf	DCP32080	
2.0 TFSI	CZPB;DKZA		05/16-	6SES14C	R134a	DCP32060	
2.0 TFSI	CZPB;DKZA		05/16-	6SES14C	R134a; R1234yf	DCP32080	
2.0 TFSI quattro	CZPB;DKZA		05/16-	6SES14C	R134a	DCP32060	
2.0 TFSI quattro	CZPB;DKZA		05/16-	6SES14C	R134a; R1234yf	DCP32080	
<b>A3 Convertible (8P7) (08-13)</b>							
1.2 TFSI	CBZB	For cold climates;For mild climate zones	03/10-05/13	6SEU14C	R134a	DCP02030	
1.2 TFSI	CBZB	For hot climate zones	03/10-05/13	7SEU17C	R134a	DCP32045	
1.4 TFSI	CAXC	For cold climates;For mild climate zones	02/11-05/13	6SEU14C	R134a	DCP02030	





				TYPE	GAS	DENSO PN	OE
<b>AUDI</b> <i>Continued</i>							
<b>A3 Convertible (8P7) (08-13)</b> <i>Continued</i>							
1.4 TFSI	CAXC	For hot climate zones	02/11-05/13	7SEU17C	R134a	DCP32045	
1.6	BSE	For cold climates;For mild climate zones	09/08-05/10	6SEU14C	R134a	DCP02030	
1.6	BSE	For hot climate zones	09/08-05/10	7SEU17C	R134a	DCP32045	
1.6 TDI	CAYC	For cold climates;For mild climate zones	05/09-05/13	6SEU14C	R134a	DCP02050	
1.6 TDI	CAYC	For hot climate zones	05/09-05/13	7SEU17C	R134a	DCP32045	
1.8 TFSI	BZB; CDAА	For cold climates;For mild climate zones	04/08-01/09	6SEU14C	R134a	DCP02030	
1.8 TFSI	BZB; CDAА	For hot climate zones	04/08-01/09	7SEU17C	R134a	DCP32045	
1.9 TDI	BLS	For cold climates;For mild climate zones	04/08-10/09	6SEU14C	R134a	DCP02050	
1.9 TDI	BLS	For hot climate zones	04/08-10/09	7SEU17C	R134a	DCP32045	
2.0 TDI	CBAA;CBAB;CFFA;CFFB	For cold climates;For mild climate zones	04/08-05/13	6SEU14C	R134a	DCP02050	
2.0 TDI	CBAA;CBAB;CFFA;CFFB	For hot climate zones	04/08-05/13	7SEU17C	R134a	DCP32045	
2.0 TFSI	CAWB	For cold climates;For mild climate zones	04/08-01/09	6SEU14C	R134a	DCP02030	
2.0 TFSI	CAWB	For hot climate zones	04/08-01/09	7SEU17C	R134a	DCP32045	
<b>A3 Convertible (8V7) (13-)</b>							
1.4 TFSI	CPTA;CXSB;CZCA		10/13-	6SES14C	R134a	DCP32060	
1.4 TFSI	CPTA;CXSB;CZCA;CZCC		10/13-	6SES14C	R134a; R1234yf	DCP32080	
1.4 TSI	CZEA		05/14-	6SES14C	R134a	DCP32060	
1.4 TSI	CZEA		05/14-	6SES14C	R134a; R1234yf	DCP32080	
1.5 TFSI	DADA		05/17-10/18	6SES14C	R134a	DCP32060	
1.6 TDI	CRKB; CXXB		02/14-	6SES14C	R134a	DCP32060	
1.6 TDI	CRKB;CXXB;DDYA		02/14-	6SES14C	R134a; R1234yf	DCP32080	
1.8 TFSI	CJSA;CJSB;CNSB		10/13-	6SES14C	R134a	DCP32060	
1.8 TFSI	CJSA;CJSB;CNSB		10/13-	6SES14C	R134a; R1234yf	DCP32080	
1.8 TFSI quattro	CJSB		03/14-	6SES14C	R134a	DCP32060	
1.8 TFSI quattro	CJSB		03/14-	6SES14C	R134a; R1234yf	DCP32080	
2.0 S3 quattro	CJXC;CJXF;DJHA;DNUE		03/14-	6SES14C	R134a	DCP32060	
2.0 S3 quattro	CJXC;CJXF;DNUE		03/14-	6SES14C	R134a; R1234yf	DCP32080	
2.0 TDI	CRLB;CRLC;CUNA;DCYA		10/13-	6SES14C	R134a	DCP32060	
2.0 TDI	CRLB;CRLC;CUNA;DCYA		10/13-	6SES14C	R134a; R1234yf	DCP32080	
2.0 TDI quattro	CRLB;CUNA;DCYA;DGCA		03/14-	6SES14C	R134a	DCP32060	
2.0 TDI quattro	CRLB;CUNA;DCYA;DGCA		03/14-	6SES14C	R134a; R1234yf	DCP32080	
2.0 TFSI	CZPB		05/16-	6SES14C	R134a	DCP32060	
2.0 TFSI	CZPB		05/16-	6SES14C	R134a; R1234yf	DCP32080	
2.0 TFSI quattro	CNTC;CZPB		05/14-	6SES14C	R134a	DCP32060	
2.0 TFSI quattro	CNTC;CZPB		05/14-	6SES14C	R134a; R1234yf	DCP32080	
<b>A4 (8D, B5) (94-01)</b>							
1.6	AHL;ALZ;ANA;ARM		10/96-09/01	7SBU16C	R134a	DCP02006	
1.8 T	AEB;ANB;APU;ARK;AWT		10/95-09/01	7SBU16C	R134a	DCP02006	
1.8 T quattro	ARK		02/99-07/99	7SBU16C	R134a	DCP02006	8D0260805B
1.9 TDI	AHH		04/97-12/98	7SBU16C	R134a	DCP02005	4B0260805B
1.9 TDI	AJM		03/00-09/01	7SBU16C	R134a	DCP02006	
1.9 TDI quattro	ATJ		03/00-11/00	7SBU16C	R134a	DCP02006	8D0260805B
2.4	AGA;AJG;ALF;AML;AMM;APS;APZ;ARJ		03/97-09/01	7SBU16C	R134a	DCP02005	
2.4	AML		06/00-11/00	7SBU16C	R134a	DCP02006	8D0260805B

				TYPE	GAS	DENSO PN	OE
<b>AUDI</b> <i>Continued</i>							
<b>A4 (8D, B5) (94-01)</b> <i>Continued</i>							
2.4 quattro	AGA;AJG;ALF;AML;APS;APZ;ARJ		08/97-09/01	7SBU16C	R134a	DCP02005	
2.4 quattro	AML		07/99-11/00	7SBU16C	R134a	DCP02006	8D0260805B
2.5 TDI	AFB;AKN		09/97-11/00	7SBU16C	R134a	DCP02004	
2.5 TDI quattro	AFB;AKN		09/97-11/00	7SBU16C	R134a	DCP02004	
2.6	ABC;ACZ		11/95-12/98	7SBU16C	R134a	DCP02005	4B0260805B
2.6 quattro	ABC		08/97-07/98	7SBU16C	R134a	DCP02006	8D0260805B
2.6 quattro	ABC;ACZ		01/95-12/98	7SBU16C	R134a	DCP02005	4B0260805B
2.7 RS4	ASJ; AZR		05/00-09/01	7SBU16C	R134a	DCP02005	4B0260805B
2.7 S4 quattro	AGB		09/97-09/01	7SBU16C	R134a	DCP02005	4B0260805B
2.7 S4 quattro	AGB		02/99-09/01	7SEU14C	R134a	DCP02045	8E0260805F
2.7 S4 quattro	AGB		02/99-09/01	6SEU12C	R134a	DCP02048	8E0260805G
2.8	AAH;ACK;AHA;ALG;AMX;APR;AQD;ATQ;AT X		09/95-09/01	7SBU16C	R134a	DCP02005	
2.8 quattro	AAH;ACK;AHA;ALG;AMX;APR;AQD;ATQ;AT X		01/95-09/01	7SBU16C	R134a	DCP02005	
<b>A4 (8E, B6) (00-04)</b>							
1.6	ALZ		01/03-03/04	6SEU12C	R134a	DCP02012	8E0260805AF
1.6	ALZ	For cold climates;For mild climate zones	11/00-12/04	6SEU12C	R134a	DCP02048	8E0260805G
1.6	ALZ	For hot climate zones	11/00-12/04	7SEU14C	R134a	DCP02045	8E0260805F
1.8 T	AMB		07/01-06/02	7SEU16C	R134a	DCP02010	8E0260805
1.8 T	AMB;AVJ;BEX;BFB		07/01-12/04	7SEU14C	R134a	DCP02045	8E0260805F
1.8 T	AMB;AVJ;BEX;BFB		07/01-12/04	6SEU12C	R134a	DCP02048	8E0260805G
1.8 T	AVJ	For cold climates;For mild climate zones	11/00-07/02	6SEU12C	R134a	DCP02048	8E0260805G
1.8 T	AVJ	For hot climate zones	11/00-07/02	7SEU14C	R134a	DCP02045	8E0260805F
1.8 T	BEX;BFB		11/02-03/04	6SEU12C	R134a	DCP02012	8E0260805AF
1.8 T	BEX;BFB		03/04-12/04	6SEU14C	R134a	DCP02038	8E0260805AG
1.8 T	BEX;BFB		03/04-12/04	6SEU14C	R134a	DCP02041	8E0260805BP
1.8 T quattro	AMB;AVJ;BEX;BFB		11/00-12/04	7SEU14C	R134a	DCP02045	8E0260805F
1.8 T quattro	AMB;AVJ;BEX;BFB		11/00-12/04	6SEU12C	R134a	DCP02048	8E0260805G
1.8 T quattro	AMB;BEX;BFB		07/02-03/04	6SEU12C	R134a	DCP02012	8E0260805AF
1.8 T quattro	BEX;BFB		11/02-12/04	6SEU14C	R134a	DCP02038	8E0260805AG
1.8 T quattro	BEX;BFB		11/02-12/04	6SEU14C	R134a	DCP02041	8E0260805BP
1.9 TDI	AVB		05/01-05/04	7SEU16C	R134a	DCP02010	8E0260805
1.9 TDI	AVB		01/03-05/03	6SEU12C	R134a	DCP02024	8E0260805AH
1.9 TDI	AVB		01/03-05/03	7SEU16C	R134a	DCP02026	8E0260805T
1.9 TDI	AVB;BKE		06/03-12/04	6SEU14C	R134a	DCP02038	8E0260805AG
1.9 TDI	AVB;BKE		06/03-12/04	6SEU14C	R134a	DCP02041	8E0260805BP
1.9 TDI	AVF;AWX	Ch No: >8E-3-285 000	11/00-01/03	7SEU16C	R134a	DCP02010	8E0260805
1.9 TDI	AVF;AWX	Ch No: 8E-3-285 001>8E-3-500 000	02/03-05/03	7SEU16C	R134a	DCP02026	8E0260805T
1.9 TDI	AVF;AWX	Ch No: 8E-4-000 001>	06/03-12/04	6SEU14C	R134a	DCP02038	8E0260805AG
1.9 TDI quattro	AVF	Ch No: >8E-3-285 000	11/01-01/03	7SEU16C	R134a	DCP02010	8E0260805
1.9 TDI quattro	AVF	Ch No: 8E-3-285 001>8E-3-500 000	02/03-05/03	7SEU16C	R134a	DCP02026	8E0260805T
1.9 TDI quattro	AVF	Ch No: 8E-4-000 001>	06/03-12/04	6SEU14C	R134a	DCP02038	8E0260805AG
2.0	ALT		09/01-12/04	7SEU14C	R134a	DCP02045	8E0260805F
2.0	ALT		09/01-12/04	6SEU12C	R134a	DCP02048	8E0260805G
2.0	ALT		01/03-03/04	6SEU12C	R134a	DCP02012	8E0260805AF
2.0	ALT		03/04-12/04	6SEU14C	R134a	DCP02038	8E0260805AG
2.0	ALT		03/04-12/04	6SEU14C	R134a	DCP02041	8E0260805BP
2.0	ALT	Ch No: >8E-2-285 000, Heavy duty version	11/00-03/04	7SEU14C	R134a	DCP02045	8E0260805F
2.0	ALT	Ch No: >8E-3-285-000	11/00-01/03	6SEU12C	R134a	DCP02048	8E0260805G
2.0	ALT	Ch No: 8E-3-285 001>8E-4-237 000	01/03-03/04	6SEU12C	R134a	DCP02012	8E0260805AF

				TYPE	GAS	DENSO PN	OE
<b>AUDI Continued</b>							
<b>A4 (8E, B6) (00-04) Continued</b>							
2.0	ALT	Ch No: 8E-3-285 001>8E-4-237 000, Heavy duty version	03/04-12/04	6SEU14C	R134a	DCP02041	8E0260805BP
2.0	ALT	Ch No: 8E-4-237 001>	03/04-12/04	6SEU14C	R134a	DCP02038	8E0260805AG
2.0 FSI	AWA		07/02-12/04	7SEU14C	R134a	DCP02045	8E0260805F
2.0 FSI	AWA		07/02-12/04	6SEU12C	R134a	DCP02048	8E0260805G
2.0 FSI	AWA		01/03-03/04	6SEU12C	R134a	DCP02012	8E0260805AF
2.0 FSI	AWA		03/04-12/04	6SEU14C	R134a	DCP02038	8E0260805AG
2.0 FSI	AWA		03/04-12/04	6SEU14C	R134a	DCP02041	8E0260805BP
2.4	AMM;BDV		09/01-12/04	7SEU16C	R134a	DCP02022	4E0260805E
2.4	AMM;BDV		09/01-12/04	7SEU14C	R134a	DCP02045	8E0260805F
2.4	AMM;BDV		09/01-12/04	6SEU12C	R134a	DCP02048	8E0260805G
2.4	AMM;BDV		01/03-02/04	7SEU16C	R134a	DCP02025	8E0260805S
2.4	AMM;BDV		02/04-12/04	7SEU17C	R134a	DCP02027	8E0260805AJ
2.4	AMM;BDV		02/04-12/04	6SEU14C	R134a	DCP02028	8E0260805AS
2.5 TDI	AYM		08/01-07/02	6SEU12C	R134a	DCP02008	
2.5 TDI	BDG	Ch No: 8E-4-237 000>	10/03-12/04	6SEU14C	R134a	DCP02039	
2.5 TDI	BDG;BFC	Ch No: 8E-3-285 001>8E-4-237 000	07/02-03/04	6SEU12C	R134a	DCP02023	
2.5 TDI	BFC	Ch No: >8E-3-285 000	07/02-01/03	6SEU12C	R134a	DCP02008	
2.5 TDI quattro	AKE	Ch No: >8E-3-285 000	12/00-05/03	6SEU12C	R134a	DCP02008	
2.5 TDI quattro	AKE;BAU;BDH	Ch No: 8E-3-285 001>8E-4-237 000	12/00-03/04	6SEU12C	R134a	DCP02023	
2.5 TDI quattro	BAU;BDH	Ch No: 8E-4-237 001>	05/03-12/04	6SEU14C	R134a	DCP02039	
3.0	ASN		11/00-02/04	7SEU16C	R134a	DCP02025	8E0260805S
3.0	ASN;AVK		11/00-12/04	7SEU16C	R134a	DCP02022	4E0260805E
3.0	ASN;AVK;BBJ		11/00-12/04	7SEU14C	R134a	DCP02045	8E0260805F
3.0	ASN;AVK;BBJ		11/00-12/04	6SEU12C	R134a	DCP02048	8E0260805G
3.0	ASN;BBJ		11/00-12/04	7SEU17C	R134a	DCP02027	8E0260805AJ
3.0	ASN;BBJ		11/00-12/04	6SEU14C	R134a	DCP02028	8E0260805AS
3.0	BBJ	Ch No: 8E-4-211 501>	02/04-12/04	7SEU17C	R134a	DCP02027	8E0260805AJ
3.0	BBJ	Ch No: 8E-4-211 501>	02/04-12/04	6SEU14C	R134a	DCP02028	8E0260805AS
3.0 quattro	ASN		11/00-02/04	7SEU16C	R134a	DCP02025	8E0260805S
3.0 quattro	ASN;AVK		11/00-12/04	7SEU16C	R134a	DCP02022	4E0260805E
3.0 quattro	ASN;AVK;BBJ		11/00-12/04	7SEU14C	R134a	DCP02045	8E0260805F
3.0 quattro	ASN;AVK;BBJ		11/00-12/04	6SEU12C	R134a	DCP02048	8E0260805G
3.0 quattro	ASN;BBJ		11/00-12/04	7SEU17C	R134a	DCP02027	8E0260805AJ
3.0 quattro	ASN;BBJ		11/00-12/04	6SEU14C	R134a	DCP02028	8E0260805AS
4.2 S4 quattro	BBK		03/03-12/04	7SEU17C	R134a	DCP02015	4F0260805AD
4.2 S4 quattro	BBK		03/03-12/04	7SEU17C	R134a	DCP02031	4E0260805AR
4.2 S4 quattro	BBK		03/03-12/04	7SEU17C	R134a	DCP02033	4E0260805AA
4.2 S4 quattro	BBK		03/03-12/04	7SEU17C	R134a	DCP02064	8K0260805H
<b>A4 (8E, B7) (04-08)</b>							
1.6	ALZ		11/04-05/06	6SEU14C	R134a	DCP02038	8E0260805AG
1.6	ALZ		11/04-06/08	6SEU14C	R134a	DCP02041	8E0260805BP
1.8 T	BFB		11/04-06/08	6SEU14C	R134a	DCP02038	8E0260805AG
1.8 T	BFB		11/04-06/08	6SEU14C	R134a	DCP02041	8E0260805BP
1.8 T quattro	BFB		11/04-02/05	6SEU14C	R134a	DCP02038	8E0260805AG
1.8 T quattro	BFB		11/04-06/08	6SEU14C	R134a	DCP02041	8E0260805BP
1.9 TDI	BKE;BRB	Ch No: >8E-6-400 000*	11/04-06/08	6SEU14C	R134a	DCP02038	
1.9 TDI	BKE;BRB	Ch No: 8E-7-000 001>	11/04-06/08	6SEU14C	R134a	DCP02041	8E0260805CB
1.9 TDI	BKE;BRB	Ch No: 8E-7-000-001>	11/04-06/08	6SEU14C	R134a	DCP02052	8E0260805CG
2.0	ALT		11/04-05/06	6SEU14C	R134a	DCP02041	8E0260805BP
2.0	ALT		11/04-06/08	6SEU14C	R134a	DCP02038	8E0260805AG
2.0 Tdi	BLB;BNA;BRD;BRE;BRF;BVA;BVF;BVG	Ch No: >8E-6-400 000*	11/04-06/08	6SEU14C	R134a	DCP02038	





				TYPE	GAS	DENSO PN	OE
<b>AUDI</b> <i>Continued</i>							
<b>A4 (8E, B7) (04-08)</b> <i>Continued</i>							
2.0 TDi	BLB;BNA;BRD;BRE;BRF;BVA;BVF;BVG	Ch No: 8E-7-000 001>	11/04-06/08	6SEU14C	R134a	DCP02041	8E0260805CB
2.0 TDi	BLB;BNA;BRD;BRE;BRF;BVA;BVF;BVG	Ch No: 8E-7-000-001>	11/04-06/08	6SEU14C	R134a	DCP02052	8E0260805CG
2.0 TDi 8V	BPW	Ch No: >8E-6-400 000*	11/04-06/08	6SEU14C	R134a	DCP02038	
2.0 TDi 8V	BPW	Ch No: 8E-7-000 001>	11/04-06/08	6SEU14C	R134a	DCP02041	8E0260805CB
2.0 TDi 8V	BPW	Ch No: 8E-7-000-001>	11/04-06/08	6SEU14C	R134a	DCP02052	8E0260805CG
2.0 TDi 8V quattro	BPW	Ch No: >8E-6-400 000*	01/06-06/08	6SEU14C	R134a	DCP02038	
2.0 TDi 8V quattro	BPW	Ch No: 8E-7-000 001>	01/06-06/08	6SEU14C	R134a	DCP02041	8E0260805CB
2.0 TDi 8V quattro	BPW	Ch No: 8E-7-000-001>	01/06-06/08	6SEU14C	R134a	DCP02052	8E0260805CG
2.0 TDi quattro	BRD;BVA	Ch No: >8E-6-400 000*	06/06-06/08	6SEU14C	R134a	DCP02038	
2.0 TDi quattro	BRD;BVA	Ch No: 8E-7-000 001>	06/06-06/08	6SEU14C	R134a	DCP02041	8E0260805CB
2.0 TDi quattro	BRD;BVA	Ch No: 8E-7-000-001>	06/06-06/08	6SEU14C	R134a	DCP02052	8E0260805CG
2.0 TFSI	BGB;BPJ;BUL;BWE;BYK		11/04-06/08	6SEU14C	R134a	DCP02041	8E0260805BP
2.0 TFSI	BGB;BUL;BWE		11/04-05/06	6SEU14C	R134a	DCP02038	8E0260805AG
2.0 TFSI quattro	BGB;BUL;BWE		11/04-05/06	6SEU14C	R134a	DCP02038	8E0260805AG
2.0 TFSI quattro	BGB;BUL;BWE		11/04-06/08	6SEU14C	R134a	DCP02041	8E0260805BP
2.5 TDI	BDG		11/04-05/06	6SEU14C	R134a	DCP02039	
2.7 TDI	BPP;BSG		11/05-06/08	6SEU14C	R134a	DCP02038	8E0260805AG
2.7 TDI	BPP;BSG		11/05-06/08	6SEU14C	R134a	DCP02041	8E0260805BP
2.7 TDI	BPP;BSG		11/05-06/08	6SEU14C	R134a	DCP02065	8E0260805CD
3.0	BBJ		11/04-05/06	7SEU17C	R134a	DCP02032	4E0260805AG
3.0	BBJ		11/04-05/06	7SEU17C	R134a	DCP02034	
3.0 quattro	BBJ		11/04-07/06	7SEU17C	R134a	DCP02032	4E0260805AG
3.0 quattro	BBJ		11/04-07/06	7SEU17C	R134a	DCP02034	
3.0 TDi quattro	ASB;BKN		11/04-06/08	6SEU14C	R134a	DCP02038	8E0260805AG
3.0 TDi quattro	ASB;BKN		11/04-06/08	6SEU14C	R134a	DCP02041	8E0260805BP
3.0 TDi quattro	ASB;BKN		11/04-06/08	6SEU14C	R134a	DCP02065	8E0260805CD
3.2 FSI	AUK		01/05-06/08	7SEU17C	R134a	DCP02031	4E0260805AR
3.2 FSI	AUK		01/05-06/08	7SEU17C	R134a	DCP02033	8E0260805BD
3.2 FSI	AUK	For cold climates	01/05-06/08	6SEU14C	R134a	DCP02043	8E0260805BC
3.2 FSI quattro	AUK;BKH		01/05-06/08	7SEU17C	R134a	DCP02031	4E0260805AR
3.2 FSI quattro	AUK;BKH		01/05-06/08	7SEU17C	R134a	DCP02033	8E0260805BD
3.2 FSI quattro	AUK;BKH	For cold climates	01/05-06/08	6SEU14C	R134a	DCP02043	8E0260805BC
4.2 RS4	BNS		09/05-06/08	7SEU17C	R134a	DCP02015	4F0260805AD
4.2 RS4	BNS		09/05-06/08	7SEU17C	R134a	DCP02031	4E0260805AR
4.2 RS4	BNS		09/05-06/08	7SEU17C	R134a	DCP02033	4E0260805AA
4.2 RS4	BNS		09/05-06/08	7SEU17C	R134a	DCP02064	8K0260805H
4.2 S4 quattro	BBK		11/04-06/08	7SEU17C	R134a	DCP02015	4F0260805AD
4.2 S4 quattro	BBK		11/04-06/08	7SEU17C	R134a	DCP02033	4E0260805AA
4.2 S4 quattro	BBK;BHF		11/04-06/08	7SEU17C	R134a	DCP02031	4E0260805AR
4.2 S4 quattro	BBK;BHF		11/04-06/08	7SEU17C	R134a	DCP02064	8K0260805H
<b>A4 (8K, B8) (07-15)</b>							
1.8 TFSI	CABA;CABB;CDHA;CDHB		11/07-12/11	6SEU14C	R134a	DCP02060	
1.8 TFSI	CABA;CABB;CDHA;CDHB		11/07-01/12	6SEU14C	R134a	DCP02042	
1.8 TFSI	CABA;CDHA;CJEB		11/11-03/12	6SEU14C	R134a	DCP32061	
1.8 TFSI	CABA;CDHA;CJEB		03/12-12/15	6SEU14C	R134a	DCP02097	
1.8 TFSI quattro	CDHB		09/08-01/12	6SEU14C	R134a	DCP02042	
1.8 TFSI quattro	CDHB		09/08-01/12	6SEU14C	R134a	DCP02060	8KD260805
1.8 TFSI quattro	CJEB		11/11-03/12	6SEU14C	R134a	DCP32061	
1.8 TFSI quattro	CJEB		03/12-12/15	6SEU14C	R134a	DCP02097	
2.0 TDi	CABB;CAGA;CAGB;CAGC/F;CAHA;CAHB;CDHB;CJCB;CMEA;CSUB		11/07-03/12	6SEU14C	R134a	DCP02060	8KD260805
2.0 TDi	CAGA;CAGB;CAGC;CAHA;CAHB;CJCB;CMEA		11/07-03/12	6SEU14C	R134a	DCP02042	
2.0 TDi	CAGA;CAGC;CAHA;CAHB;CGLC;CGLD;CJCA;CJCB;CJCC;CMFA;CNHC		11/11-03/12	6SBU14C	R134a	DCP02101	
2.0 TDi	CAGA;CAGC;CAHB;CGLC;CGLD;CJCA;CJCB;CJCC;CJCD;CMFA;CMFB;CNHA;CNHC		03/12-12/15	6SAS14C	R134a	DCP02098	

				TYPE	GAS	DENSO PN	OE
<b>AUDI Continued</b>							
<b>A4 (8K, B8) (07-15) Continued</b>							
2.0 TDI quattro	CAGA;CAHA		01/08-11/11	6SEU14C	R134a	DCP02042	
2.0 TDI quattro	CAGA;CAHA		04/08-01/12	6SEU14C	R134a	DCP02060	8KD260805
2.0 TDI quattro	CAGA;CAHA;CGLC;CJCA		11/11-03/12	6SBU14C	R134a	DCP02101	
2.0 TDI quattro	CAGA;CGLC;CJCA;CJCD;CNHA		03/12-12/15	6SAS14C	R134a	DCP02098	
2.0 TFSI	CAEA;CDNB;CDNC;CFKA (E85);CFKA		06/08-01/12	6SEU14C	R134a	DCP02060	8KD260805
2.0 TFSI	CAEB;CDNB;CDNC;CFKA		06/08-01/12	6SEU14C	R134a	DCP02042	
2.0 TFSI	CAEB;CDNB;CDNC;CFKA		11/11-03/12	6SEU14C	R134a	DCP32061	
2.0 TFSI	CAEB;CDNB;CDNC;CNCD		03/12-12/15	6SEU14C	R134a	DCP02097	
2.0 TFSI FlexFuel	CFKA		11/09-12/11	6SEU14C	R134a	DCP02060	8KD260805
2.0 TFSI FlexFuel	CFKA		11/09-01/12	6SEU14C	R134a	DCP02042	
2.0 TFSI FlexFuel	CFKA		11/11-03/12	6SEU14C	R134a	DCP32061	
2.0 TFSI FlexFuel	CFKA		03/12-12/15	6SEU14C	R134a	DCP02097	
2.0 TFSI FlexFuel quattro	CFKA		11/09-12/11	6SEU14C	R134a	DCP02060	8KD260805
2.0 TFSI FlexFuel quattro	CFKA		11/09-01/12	6SEU14C	R134a	DCP02042	
2.0 TFSI FlexFuel quattro	CFKA		11/11-03/12	6SEU14C	R134a	DCP32061	
2.0 TFSI FlexFuel quattro	CFKA		03/12-12/15	6SEU14C	R134a	DCP02097	
2.0 TFSI quattro	CAEB;CAED;CDNC;CNCD;CPMA;CPMB		03/12-12/15	6SEU14C	R134a	DCP02097	
2.0 TFSI quattro	CAEB;CDNC		06/08-01/12	6SEU14C	R134a	DCP02042	
2.0 TFSI quattro	CAEB;CDNC		06/08-01/12	6SEU14C	R134a	DCP02060	8KD260805
2.0 TFSI quattro	CAEB;CDNC;CPMA		11/11-03/12	6SEU14C	R134a	DCP32061	
2.7 TDI	CAMA;CAMB;CGKA;CGKB		11/07-03/12	6SEU14C	R134a	DCP02092	
3.0 S4 quattro	CAKA		11/08-03/12	6SEU14C	R134a	DCP02043	
3.0 S4 quattro	CAKA;CCBA;CGWC;CGXC;CREC;CTUB		03/12-12/15	6SES14C	R134a	DCP02105	
3.0 TDI	CLAB		11/11-03/12	6SEU14C	R134a	DCP02092	
3.0 TDI	CLAB		03/12-12/15	6SES14C	R134a	DCP02102	
3.0 TDI quattro	CAPA		11/07-05/08	6SEU14C	R134a	DCP02044	
3.0 TDI quattro	CAPA;CCLA;CCWA;CCWB;CDUC;CKVB		04/08-12/15	6SEU14C	R134a	DCP02092	
3.0 TDI quattro	CKVB		03/12-12/15	6SES14C	R134a	DCP02102	
3.0 TFSI quattro	CMUA;CRED		02/12-03/12	6SEU14C	R134a	DCP02043	
3.0 TFSI quattro	CMUA;CRED		03/12-12/15	6SES14C	R134a	DCP02105	
3.2 FSI	CALA		09/08-03/12	6SEU14C	R134a	DCP02043	
3.2 FSI quattro	CALA		11/07-03/12	6SEU14C	R134a	DCP02043	
<b>A4 (8W, B9) (15-)</b>							
1.4 TFSI	CVNA		08/15-11/19	6SES14C	R134a; R1234yf	DCP02106	
1.4 TFSI	CVNA	For vehicles with automatic climate control	08/15-11/19	6SEU14C	R134a	DCP02097	
2.0 TDI	CZHA;DESA;DETA;DEUA;DEUB;DEUC;DFV A		05/15-	6SES14C	R134a; R1234yf	DCP02106	
2.0 TDI	CZHA;DESA;DETA;DEUA;DEUB;DFVA	For vehicles with automatic climate control	05/15-	6SES14C	R134a	DCP02105	
2.0 TDI quattro	DESA;DETA;DEUA;DFVA		09/15-	6SES14C	R134a; R1234yf	DCP02106	
2.0 TDI quattro	DESA;DETA;DFVA	For vehicles with automatic climate control	09/15-	6SES14C	R134a	DCP02105	
2.0 TFSI	CVKB;CYMC;CYRB;CYRC		05/15-	6SES14C	R134a; R1234yf	DCP02106	
2.0 TFSI	CVKB;CYMC;CYRB;CYRC;DBPA	For vehicles with automatic climate control	05/15-	6SEU14C	R134a	DCP02097	
2.0 TFSI g-tron	CVLA		11/16-10/19	6SES14C	R134a; R1234yf	DCP02106	
2.0 TFSI quattro	CYMC;CYRB;CYRC		05/15-	6SES14C	R134a; R1234yf	DCP02106	
2.0 TFSI quattro	CYMC;CYRB;CYRC	For vehicles with automatic climate control	05/15-	6SEU14C	R134a	DCP02097	
3.0 TDI	CSWB		10/15-08/18	6SES14C	R134a	DCP02102	
3.0 TDI	CSWB	For vehicles with automatic climate control	09/15-08/18	6SES14C	R134a	DCP02105	
3.0 TDI quattro	CRTC;CSWB		08/15-08/18	6SES14C	R134a	DCP02102	
3.0 TDI quattro	CRTC;CSWB	For vehicles with automatic climate control	05/15-08/18	6SES14C	R134a	DCP02105	
<b>A4 Allroad (8KH) (09-16)</b>							
2.0 TDI quattro	CAGA;CAGB;CAHA;CAHB		04/09-12/11	6SEU14C	R134a	DCP02060	8KD260805
2.0 TDI quattro	CAGA;CAGB;CAHA;CAHB		04/09-01/12	6SEU14C	R134a	DCP02042	
2.0 TDI quattro	CGLC;CGLD;CJCA;CJCB;CJCD;CNHA		03/12-05/16	6SAS14C	R134a	DCP02098	
2.0 TFSI quattro	CDNC		04/09-12/11	6SEU14C	R134a	DCP02060	8KD260805
2.0 TFSI quattro	CDNC		04/09-01/12	6SEU14C	R134a	DCP02042	





				TYPE	GAS	DENSO PN	OE
<b>AUDI</b> <i>Continued</i>							
<b>A4 Allroad (8KH) (09-16)</b> <i>Continued</i>							
2.0 TFSI quattro	CDNC; CPMA		11/11-03/12	6SEU14C	R134a	DCP32061	
2.0 TFSI quattro	CDNC;CNCD;CPMA;CPMB		04/09-05/16	6SEU14C	R134a	DCP02097	
3.0 TDI quattro	CCWA		04/09-01/12	6SEU14C	R134a	DCP02092	
3.0 TDI quattro	CDUC; CKVB		01/12-05/16	6SES14C	R134a	DCP02102	
<b>A4 Allroad (8WH) (16-)</b>							
2.0 TDI quattro	DESA;DETA;DETB;DEUA;DEUB;DFVA		01/16-	6SES14C	R134a; R1234yf	DCP02106	
2.0 TFSI quattro	CYMC;CYRB;CYRC		01/16-	6SES14C	R134a; R1234yf	DCP02106	
<b>A4 Convertible (8H, B6, B7) (02-09)</b>							
1.8 T	BFB		07/02-01/03	7SEU14C	R134a	DCP02045	8E0260805F
1.8 T	BFB		07/02-01/03	6SEU12C	R134a	DCP02048	8E0260805G
1.8 T	BFB		07/02-03/09	7SEU16C	R134a	DCP02022	4E0260805E
1.8 T	BFB		01/03-12/05	6SEU12C	R134a	DCP02012	8E0260805AF
1.8 T	BFB		01/03-12/05	7SEU16C	R134a	DCP02025	8E0260805S
1.8 T	BFB		03/04-02/06	6SEU14C	R134a	DCP02038	8E0260805AG
1.8 T	BFB		03/04-03/09	6SEU14C	R134a	DCP02041	8E0260805BP
1.8 T quattro	BFB		05/03-05/04	6SEU12C	R134a	DCP02012	8E0260805AF
1.8 T quattro	BFB		05/03-05/04	7SEU16C	R134a	DCP02025	8E0260805S
1.8 T quattro	BFB		05/03-12/05	6SEU14C	R134a	DCP02038	8E0260805AG
1.8 T quattro	BFB		05/03-12/05	6SEU14C	R134a	DCP02041	8E0260805BP
1.8 T quattro	BFB		05/03-03/09	7SEU16C	R134a	DCP02022	4E0260805E
2.0	ALT		09/04-12/05	6SEU14C	R134a	DCP02038	8E0260805AG
2.0	ALT		09/04-12/05	6SEU14C	R134a	DCP02041	8E0260805BP
2.0 TDI 8V	BPW;BRC		01/06-03/09	6SEU14C	R134a	DCP02038	8E0260805AG
2.0 TDI 8V	BPW;BRC		01/06-03/09	6SEU14C	R134a	DCP02041	8E0260805BP
2.0 TFSI 16V	BWE		01/06-02/06	6SEU14C	R134a	DCP02038	8E0260805AG
2.0 TFSI 16V	BWE		01/06-03/09	6SEU14C	R134a	DCP02041	8E0260805BP
2.4	AMM;BDV		04/02-01/03	7SEU14C	R134a	DCP02045	8E0260805F
2.4	AMM;BDV		04/02-04/05	6SEU14C	R134a	DCP02028	8E0260805AS
2.4	AMM;BDV		04/02-12/05	7SEU16C	R134a	DCP02022	4E0260805E
2.4	AMM;BDV		04/02-12/05	7SEU17C	R134a	DCP02032	4E0260805AG
2.4	AMM;BDV		01/03-12/05	7SEU16C	R134a	DCP02025	8E0260805S
2.4	AMM;BDV		01/05-12/05	7SEU17C	R134a	DCP02034	4H0260805
2.4	BDV		10/03-12/05	7SEU17C	R134a	DCP02027	8E0260805AJ
2.5 TDI	BCZ; BDG		06/03-12/05	6SEU14C	R134a	DCP02039	8E0260805AK
2.5 TDI	BCZ; BDG; BFC		01/03-03/04	6SEU12C	R134a	DCP02023	8E0260805R
2.5 TDI	BFC		08/02-01/03	6SEU12C	R134a	DCP02008	8E0260805C
2.7 TDI	BPP		06/06-03/09	6SEU14C	R134a	DCP02038	8E0260805AG
2.7 TDI	BPP		06/06-03/09	6SEU14C	R134a	DCP02041	8E0260805BP
2.7 TDI	BPP		06/06-03/09	6SEU14C	R134a	DCP02065	8E0260805CD
3.0	ASN		04/02-01/03	7SEU14C	R134a	DCP02045	8E0260805F
3.0	ASN		04/02-12/05	7SEU16C	R134a	DCP02022	4E0260805E
3.0	ASN		01/03-12/05	7SEU16C	R134a	DCP02025	8E0260805S
3.0	ASN		10/03-12/05	6SEU14C	R134a	DCP02028	8E0260805AS
3.0	ASN		05/04-12/05	7SEU17C	R134a	DCP02027	8E0260805AJ
3.0	BBJ	Ch No: >8H-3-026 000	04/02-01/03	7SEU14C	R134a	DCP02045	
3.0	BBJ	Ch No: 8E-4-211 501>	10/03-12/05	7SEU17C	R134a	DCP02027	8E0260805AJ
3.0	BBJ	Ch No: 8E-4-211 501>	10/03-12/05	6SEU14C	R134a	DCP02028	8E0260805AS
3.0	BBJ	Ch No: 8H-3-026 001>8H-4-028 000	04/02-12/05	7SEU16C	R134a	DCP02025	
3.0 quattro	ASN		05/03-05/04	7SEU16C	R134a	DCP02025	8E0260805S
3.0 quattro	ASN		05/03-12/05	7SEU16C	R134a	DCP02022	4E0260805E
3.0 quattro	ASN		05/03-12/05	7SEU17C	R134a	DCP02027	8E0260805AJ
3.0 TDI quattro	ASB;BKN		01/06-03/09	6SEU14C	R134a	DCP02038	8E0260805AG
3.0 TDI quattro	ASB;BKN		01/06-03/09	6SEU14C	R134a	DCP02041	8E0260805BP
3.0 TDI quattro	ASB;BKN		01/06-03/09	6SEU14C	R134a	DCP02065	8E0260805CD
3.2 FSI	AUK		01/06-03/09	7SEU17C	R134a	DCP02031	4E0260805AR
3.2 FSI	AUK	Ch No: >8H-7-005000	01/06-02/06	7SEU17C	R134a	DCP02033	8E0260805BD
3.2 FSI	AUK	For cold climates	01/06-03/09	6SEU14C	R134a	DCP02043	8E0260805BC
3.2 FSI quattro	AUK		01/06-03/09	7SEU17C	R134a	DCP02031	4E0260805AR
3.2 FSI quattro	AUK		01/06-03/09	7SEU17C	R134a	DCP02033	8E0260805BD
3.2 FSI quattro	AUK	For cold climates	01/06-03/09	6SEU14C	R134a	DCP02043	8E0260805BC



				TYPE	GAS	DENSO PN	OE
<b>AUDI</b> <i>Continued</i>							
<b>A4 Convertible (8H, B6, B7) (02-09)</b> <i>Continued</i>							
4.2 RS4 quattro	BNS		06/06-10/08	7SEU17C	R134a	DCP02015	4F0260805AD
4.2 RS4 quattro	BNS		06/06-10/08	7SEU17C	R134a	DCP02033	4E0260805AA
4.2 RS4 quattro	BNS		06/06-03/09	7SEU17C	R134a	DCP02031	4E0260805AR
4.2 RS4 quattro	BNS		06/06-03/09	7SEU17C	R134a	DCP02064	8K0260805H
4.2 S4 quattro	BBK		03/04-03/09	7SEU17C	R134a	DCP02015	4F0260805AD
4.2 S4 quattro	BBK		03/04-03/09	7SEU17C	R134a	DCP02031	4E0260805AR
4.2 S4 quattro	BBK		03/04-03/09	7SEU17C	R134a	DCP02033	4E0260805AA
4.2 S4 quattro	BBK		03/04-03/09	7SEU17C	R134a	DCP02064	8K0260805H
<b>A5 (8T, 8F) (07-17)</b>							
1.8 TFSI	CABD;CDHB		01/08-03/12	6SEU14C	R134a	DCP02060	8KD260805
1.8 TFSI	CABD;CDHB;CJEB		10/07-03/16	6SEU14C	R134a	DCP02042	
1.8 TFSI	CJEB		08/11-03/12	6SEU14C	R134a	DCP32061	
1.8 TFSI	CJEB	For vehicles with automatic climate control	10/11-03/16	6SEU14C	R134a	DCP02060	8KD260805
1.8 TFSI	CJEB;CJED;CJEE		03/12-01/17	6SEU14C	R134a	DCP02097	
2.0 TDI	CAGA;CAGB;CAHA;CAHB;CGLC;CGLD;CJCA;CJCB;CJED;CJEE		08/08-01/17	6SEU14C	R134a	DCP02042	
2.0 TDI	CAGA;CAGB;CAHA;CAHB;CGLD;CJCA;CJCB;CJED;CJEE;CJFA;CJFB;CJFC;CJFD;CJFE;CJFF;CJFG;CJFH;CJFI;CJFJ;CJFK;CJFL;CJFM;CJFN;CJFO;CJFP;CJFQ;CJFR;CJFS;CJFT;CJFU;CJFV;CJFW;CJFX;CJFY;CJFZ		08/08-03/12	6SEU14C	R134a	DCP02060	8KD260805
2.0 TDI	CGLC;CGLD;CJCA;CJCB;CJCD;CMFA;CMFB;CMFC;CMFD;CMFE;CMFF;CMFG;CMFH;CMFI;CMFJ;CMFK;CMFL;CMFM;CMFN;CMFO;CMFP;CMFQ;CMFR;CMFS;CMFT;CMFU;CMFV;CMFV;CMFW;CMFX;CMFY;CMFZ		03/12-01/17	6SAS14C	R134a	DCP02098	
2.0 TDI	CGLC;CGLD;CJCA;CJCB;CMFA		11/11-03/12	6SBU14C	R134a	DCP02101	
2.0 TDI	CGLC;CJCA	For vehicles with automatic climate control	10/11-01/17	6SEU14C	R134a	DCP02060	8KD260805
2.0 TDI	CGLD;CJCA;CJCB;CMFA		08/11-12/11	6SEU14C	R134a	DCP32061	8K0260805M
2.0 TDI quattro	CAHA		08/08-03/12	6SEU14C	R134a	DCP02060	8KD260805
2.0 TDI quattro	CAHA;CGLC		08/08-05/15	6SEU14C	R134a	DCP02042	
2.0 TDI quattro	CGLC		12/11-03/12	6SES14C	R134a	DCP02102	
2.0 TDI quattro	CGLC	For vehicles with automatic climate control	01/12-05/15	6SEU14C	R134a	DCP02060	8KD260805
2.0 TDI quattro	CGLC;CNHA		03/12-01/17	6SAS14C	R134a	DCP02098	
2.0 TFSI	CAEA;CDNB;CDNC		06/08-03/12	6SEU14C	R134a	DCP02060	8KD260805
2.0 TFSI	CAEB;CDNC	For vehicles with automatic climate control	10/11-03/12	6SEU14C	R134a	DCP02060	8KD260805
2.0 TFSI	CAEB;CDNB;CDNC		06/08-06/14	6SEU14C	R134a	DCP02042	
2.0 TFSI	CDNB;CDNC		10/11-03/12	6SEU14C	R134a	DCP32061	
2.0 TFSI	CDNB;CDNC;CNCD;CNCE		03/12-01/17	6SEU14C	R134a	DCP02097	
2.0 TFSI quattro	CAEB;CAED;CDNC;CNCD;CNCE;CPMB		03/12-01/17	6SEU14C	R134a	DCP02097	
2.0 TFSI quattro	CAEB;CDNC		10/11-03/12	6SEU14C	R134a	DCP32061	8K0260805M
2.0 TFSI quattro	CAEB;CDNC;CPMA		06/08-03/12	6SEU14C	R134a	DCP02060	8KD260805
2.0 TFSI quattro	CAEB;CDNC;CPMA		06/08-01/17	6SEU14C	R134a	DCP02042	8KD260805;8K0260805E;8K0260805L
2.7 TDI	CAMA;CAMB;CGKA;CGKB	For vehicles with automatic climate control	06/07-03/12	6SEU14C	R134a	DCP02092	
2.7 TDI	CGKA		03/09-03/12	6SEU14C	R134a	DCP02042	
2.7 TDI	CGKA/F		03/09-03/12	6SEU14C	R134a	DCP02060	8KD260805
2.7 TDI	CGKB		05/09-03/12	6SEU14C	R134a	DCP02092	
3.0 S4 quattro	CAKA;CCBA;CGWC;CGXC;CREC;CTDA;CTUB		06/09-03/12	6SEU14C	R134a	DCP02043	
3.0 S4 quattro	CAKA;CCBA;CGWC;CGXC;CREC;CTDA;CTUB		03/12-01/17	6SES14C	R134a	DCP02105	
3.0 TDI	CLAB		10/11-03/12	6SEU14C	R134a	DCP02092	
3.0 TDI	CLAB		03/12-01/17	6SES14C	R134a	DCP02102	
3.0 TDI	CLAB	For vehicles with automatic climate control	10/11-01/17	6SEU14C	R134a	DCP02092	
3.0 TDI quattro	CAPA;CCWA;CCWB;CDUC;CKVC	For vehicles with automatic climate control	06/07-01/17	6SEU14C	R134a	DCP02092	
3.0 TDI quattro	CDUC;CKVB		10/11-03/12	6SEU14C	R134a	DCP02092	
3.0 TDI quattro	CDUC;CKVB;CKVD		03/12-01/17	6SES14C	R134a	DCP02102	
3.0 TFSI quattro	CHMB;CMUA;CRED		11/11-03/12	6SEU14C	R134a	DCP02043	
3.0 TFSI quattro	CHMB;CMUA;CRED		03/12-01/17	6SES14C	R134a	DCP02105	
3.2 FSI	CALA		06/07-03/12	6SEU14C	R134a	DCP02043	
3.2 FSI	CALA		03/09-03/12	6SEU14C	R134a	DCP02060	8KD260805
3.2 FSI quattro	CALA		06/07-03/12	6SEU14C	R134a	DCP02043	











				TYPE	GAS	DENSO PN	OE
<b>AUDI</b> <i>Continued</i>							
<b>A5 (8T, 8F) (07-17)</b> <i>Continued</i>							
3.2 FSI quattro	CALA		03/09-05/10	6SEU14C	R134a	DCP02060	8KD260805
4.2 RS5 quattro	CFSA		03/10-01/17	7SEU17C	R134a	DCP02015	
4.2 RS5 quattro	CFSA		03/10-01/17	7SEU17C	R134a	DCP02064	8K0260805H
4.2 S5 quattro	CAUA		06/07-03/12	7SEU17C	R134a	DCP02015	
4.2 S5 quattro	CAUA		06/07-03/12	7SEU17C	R134a	DCP02064	8K0260805H
<b>A5 (F5) (16-)</b>							
1.4 TFSI	CVNA		11/16-	6SES14C	R134a; R1234yf	DCP02106	
2.0 TDI	CZHA;DESA;DETA;DEUA;DEUB		07/16-	6SES14C	R134a; R1234yf	DCP02106	
2.0 TDI quattro	CZHA;DESA;DETA;DEUA;DFVA		10/16-	6SES14C	R134a; R1234yf	DCP02106	
2.0 TFSI	CVKB;CYRB		09/16-	6SES14C	R134a; R1234yf	DCP02106	
2.0 TFSI g-tron	CVLA		02/17-	6SES14C	R134a; R1234yf	DCP02106	
2.0 TFSI quattro	CYMC;CYRB;CYRC		06/16-	6SES14C	R134a; R1234yf	DCP02106	
<b>A6 (4A, C4) (94-97)</b>							
2.5 TDI quattro	AEL		07/95-12/97	7SBU16C	R134a	DCP02005	
2.6	ABC;ACZ		12/95-12/97	7SBU16C	R134a	DCP02005	
2.6 quattro	ABC;ACZ		06/94-12/97	7SBU16C	R134a	DCP02005	4B0260805B
2.8	AAH;ACK;AEJ;AFC		12/95-12/97	7SBU16C	R134a	DCP02005	4B0260805B
2.8 quattro	AAH;ACK;AFC		06/94-12/97	7SBU16C	R134a	DCP02005	4B0260805B
4.2 S6 Plus quattro	AHK		04/96-12/97	7SBU16C	R134a	DCP02005	
4.2 S6 quattro	AEC		06/94-12/97	7SBU16C	R134a	DCP02005	
<b>A6 (4B, C5) (97-05)</b>							
1.8	AFY;AJP;AQE;ARH		05/97-05/01	7SBU16C	R134a	DCP02006	
1.8 T	AEB;AJL;ANB;APU;ARK;AWL;AWT		01/97-01/05	7SBU16C	R134a	DCP02006	
1.8 T quattro	AEB;AJL;ANB;APU;ARK;AWT		02/97-01/05	7SBU16C	R134a	DCP02006	
1.9 TDI	AFN;AJM;AVG		04/97-05/01	7SBU16C	R134a	DCP02006	
1.9 TDI	AVF; AWX		08/01-05/02	6SEU12C	R134a	DCP02013	4B0260805J
1.9 TDI	AVF;AWX		08/01-01/05	7SEU16C	R134a	DCP02010	8E0260805
1.9 TDI	AVF;AWX		08/01-01/05	7SEU16C	R134a	DCP02011	
2.0	ALT		08/01-01/05	7SEU16C	R134a	DCP02046	
2.4	AGA;AJG;ALF;ALW;AML;AMM;APC;APS;APZ; ARJ;ARN;ASM;BDV		02/97-01/05	7SBU16C	R134a	DCP02005	
2.4	AML;AMM		06/00-10/00	7SBU16C	R134a	DCP02006	8D0260805B
2.4 quattro	AGA;AJG;ALF;AML;APC;APS;APZ;ARJ;BDV		02/97-01/05	7SBU16C	R134a	DCP02005	
2.5 TDI	AFB		12/97-07/98	7SBU16C	R134a	DCP32001	8D0260805K
2.5 TDI	AFB;AKE;AKN		07/97-05/01	7SBU16C	R134a	DCP02004	4B0260805C
2.5 TDI	AKE;AYM;BAU;BCZ;BDG;BDH;BFC		06/01-01/05	6SEU12C	R134a	DCP02013	
2.5 TDI quattro	AFB;AKE;AKN		07/97-05/01	7SBU16C	R134a	DCP02004	
2.5 TDI quattro	AKE;BAU;BDH		06/01-01/05	6SEU12C	R134a	DCP02013	
2.7 T	AJK		02/99-05/01	7SBU16C	R134a	DCP02005	
2.7 T quattro	AJK;ARE;AZA;BES		12/97-01/05	7SBU16C	R134a	DCP02005	4B0260805B
2.8	ACK;AGE;AHA;ALG;AMX;APR;AQD;ATX;BB G		02/97-05/01	7SBU16C	R134a	DCP02005	
2.8	AMX;AQD		09/99-10/00	7SBU16C	R134a	DCP02006	8D0260805B
2.8 quattro	ACK;AGE;AHA;ALG;AMX;APR;AQD;ATX		02/97-05/01	7SBU16C	R134a	DCP02005	
3.0	ASN		08/01-01/05	7SEU16C	R134a	DCP02046	
3.0 quattro	ASN;BBJ		06/01-01/05	7SEU16C	R134a	DCP02046	
4.2 quattro	ARS;ASG		04/99-01/05	7SBU16C	R134a	DCP02005	4B0260805B
4.2 RS6 plus quattro	BRV		04/04-09/04	7SBU16C	R134a	DCP02005	
4.2 RS6 quattro	BCY		07/02-09/04	7SBU16C	R134a	DCP02005	
4.2 S6 quattro	ANK;AQJ		09/99-01/05	7SBU16C	R134a	DCP02005	
<b>A6 (4F, C6) (04-11)</b>							
2.0 TDI	BLB;BRE		07/04-10/08	7SEU17C	R134a	DCP02031	4E0260805AR
2.0 TDI	BLB;BRE	Ch No: >4F-6-250 000	07/04-06/06	6SEU14C	R134a	DCP02014	
2.0 TDI	BLB;BRE	Ch No: 4F-7-000 001>4F-8-128 000	06/06-03/08	6SEU14C	R134a	DCP02040	
2.0 TDI	BLB;BRE	Ch No: 4F-8-128 001>	03/08-10/08	7SEU17C	R134a	DCP02033	
2.0 TDI	BNA;BRF;BVG		07/04-06/06	6SEU14C	R134a	DCP02014	4F0260805G
2.0 TDI	BNA;BRF;CAGB;CAHA;CAHB		10/08-08/11	6SEU14C	R134a	DCP02042	4F0260805AP
2.0 TFSI	BPJ		04/06-05/06	6SEU14C	R134a	DCP02014	4F0260805G
2.0 TFSI	BPJ		06/06-08/11	6SEU14C	R134a	DCP02040	4F0260805AA
2.4	BDW		05/04-10/08	6SEU14C	R134a	DCP02016	4F0260805D





				TYPE	GAS	DENSO PN	OE
<b>AUDI Continued</b>							
<b>A6 (4F, C6) (04-11) Continued</b>							
2.4	BDW		01/05-10/08	6SEU14C	R134a	DCP02036	4F0260805AF
2.4 quattro	BDW		01/05-10/08	6SEU14C	R134a	DCP02036	
2.7 TDI	BPP;BSG		11/04-10/08	6SEU14C	R134a	DCP02037	
2.7 TDI	BSG;CANA;CANB		10/08-08/11	6SEU14C	R134a	DCP02090	4F0260805AJ
2.7 TDI quattro	BPP;BSG		11/04-10/08	6SEU14C	R134a	DCP02037	4F0260805AG
2.7 TDI quattro	CANC;CAND		10/08-08/11	6SEU14C	R134a	DCP02090	4F0260805AJ
2.8 FSI	BDX;CCDA;CCEA		11/06-08/11	6SEU14C	R134a	DCP02036	
2.8 FSI quattro	BDX;CCDA;CCEA		06/07-08/11	6SEU14C	R134a	DCP02036	
3.0	BBJ		08/04-05/06	6SEU14C	R134a	DCP02016	
3.0 quattro	BBJ		05/04-05/06	6SEU14C	R134a	DCP02016	
3.0 TDI quattro	ASB;BMK;BNG		05/04-10/08	6SEU14C	R134a	DCP02037	
3.0 TDI quattro	CDYA;CDYB		10/08-08/11	6SEU14C	R134a	DCP02090	4F0260805AJ
3.0 TFSI quattro	CAJA;CCAA		10/08-08/11	6SEU14C	R134a	DCP02036	
3.2 FSI	AUK		05/04-05/09	6SEU14C	R134a	DCP02036	4F0260805AF
3.2 FSI	CALA		05/09-03/11	6SEU14C	R134a	DCP02036	
3.2 FSI quattro	AUK		05/04-10/08	6SEU14C	R134a	DCP02036	4F0260805AF
4.2 FSI quattro	BVJ		06/06-03/11	7SEU17C	R134a	DCP02015	4F0260805AD
4.2 FSI quattro	BVJ		06/06-03/11	7SEU17C	R134a	DCP02033	4E0260805AA
4.2 FSI quattro	BVJ		06/06-08/11	7SEU17C	R134a	DCP02031	4E0260805AR
4.2 FSI quattro	BVJ		06/06-08/11	7SEU17C	R134a	DCP02064	8K0260805H
4.2 quattro	BAT		05/04-05/06	7SEU17C	R134a	DCP02015	4F0260805AD
4.2 quattro	BAT		05/04-05/06	7SEU17C	R134a	DCP02031	4E0260805AR
4.2 quattro	BAT		05/04-05/06	7SEU17C	R134a	DCP02033	4E0260805AA
4.2 quattro	BAT		05/04-05/06	7SEU17C	R134a	DCP02064	8K0260805H
5.0 RS6 quattro	BUH		04/08-08/10	7SEU17C	R134a	DCP02015	4F0260805AD
5.0 RS6 quattro	BUH		04/08-08/10	7SEU17C	R134a	DCP02031	4E0260805AR
5.0 RS6 quattro	BUH		04/08-08/10	7SEU17C	R134a	DCP02033	4E0260805AA
5.0 RS6 quattro	BUH		04/08-08/10	7SEU17C	R134a	DCP02064	8K0260805H
5.2 S6 quattro	BXA		03/06-08/11	7SEU17C	R134a	DCP02015	4F0260805AD
5.2 S6 quattro	BXA		03/06-08/11	7SEU17C	R134a	DCP02031	4E0260805AR
5.2 S6 quattro	BXA		03/06-08/11	7SEU17C	R134a	DCP02033	4E0260805AA
5.2 S6 quattro	BXA		03/06-08/11	7SEU17C	R134a	DCP02064	8K0260805H
<b>A6 (4G, C7) (10-18)</b>							
1.8 TFSI	CYGA		09/14-09/18	6SES14C	R134a; R1234yf	DCP02106	
2.0 TDI	CGLC;CGLD;CGLG;CMGB;CNHA;CSUE;CZ JA; DDCA;DDDA		03/11-04/15	6SEU14C	R134a	DCP32061	4G0260805D
2.0 TDI	CNHA;CZJA;DDDA		11/14-09/18	6SBU14C	R134a	DCP02110	4G0260805AB
2.0 TFSI	CAEB;CDNB		03/11-04/15	6SEU14C	R134a	DCP32061	
2.0 TFSI	CYNB;CYPA		09/14-09/18	6SES14C	R134a; R1234yf	DCP02106	
2.0 TFSI quattro	CAEB	For vehicles with automatic climate control	05/12-05/13	6SEU14C	R134a	DCP32061	
2.0 TFSI quattro	CYNB;CYPA;CYPB		05/14-09/18	6SES14C	R134a; R1234yf	DCP02106	
2.8 FSI	CHVA		11/10-04/15	6SEU14C	R134a	DCP02103	
2.8 FSI quattro	CHVA		11/10-04/15	6SEU14C	R134a	DCP02103	
3.0 TDI	CLAB		11/10-04/15	6SEU14C	R134a	DCP02099	
3.0 TDI quattro	CDUC;CDUD;CGQB;CKVB;CKVC;CLAA		03/11-04/15	6SEU14C	R134a	DCP02099	
3.0 TFSI quattro	CGWB;CGWD;CGXB;CTUA		11/10-09/18	6SEU14C	R134a	DCP02103	
4.0 S6 quattro	CEUC		02/12-09/18	6SEU14C	R134a	DCP02108	
4.0 S6 quattro	CTGE		10/14-09/18	6SES14C	R134a	DCP02109	
<b>A6 Allroad (4FH) (06-11)</b>							
2.7 TDI quattro	BPP;BSG		03/06-10/08	6SEU14C	R134a	DCP02037	
2.7 TDI quattro	CANC;CAND		10/08-08/11	6SEU14C	R134a	DCP02090	4F0260805AJ
3.0 TDI quattro	ASB;BNG		05/06-10/08	6SEU14C	R134a	DCP02037	
3.0 TDI quattro	CDYA;CDYB;CDYC		10/08-08/11	6SEU14C	R134a	DCP02090	4F0260805AJ
3.0 TFSI quattro	CAJA		10/08-08/11	6SEU14C	R134a	DCP02036	
3.2 FSI quattro	AUK		05/06-10/08	6SEU14C	R134a	DCP02036	
4.2 FSI quattro	BVJ		05/06-10/08	7SEU17C	R134a	DCP02015	4F0260805AD
4.2 FSI quattro	BVJ		05/06-10/08	7SEU17C	R134a	DCP02033	4E0260805AA
4.2 FSI quattro	BVJ		05/06-12/10	7SEU17C	R134a	DCP02031	4E0260805AR
4.2 FSI quattro	BVJ		05/06-12/10	7SEU17C	R134a	DCP02064	8K0260805H
<b>A6 Allroad (4GH) (12-18)</b>							
3.0 TDI quattro	CDUD;CGQB;CKVC;CLAA		01/12-12/14	6SEU14C	R134a	DCP02099	
3.0 TFSI quattro	CGWD		01/12-12/14	6SEU14C	R134a	DCP02103	
<b>A7 (4GA) (10-18)</b>							
2.8 FSI	CHVA		02/11-03/15	6SEU14C	R134a	DCP02103	





				TYPE	GAS	DENSO PN	OE
<b>AUDI</b> <i>Continued</i>							
<b>A7 (4GA) (10-18)</b> <i>Continued</i>							
2.8 FSI quattro	CHVA; CNYA		10/10-03/15	6SEU14C	R134a	DCP02103	
3.0 TDI	CLAB		11/10-03/15	6SEU14C	R134a	DCP02099	
3.0 TDI quattro	CDUC;CDUD;CGQB;CKVB;CKVC;CLAA		10/10-06/16	6SEU14C	R134a	DCP02099	
3.0 TFSI quattro	CGWB;CGWD;CGXB;CHMA;CTUA		10/10-03/15	6SEU14C	R134a	DCP02103	
<b>A8 (4D) (94-02)</b>							
2.5 TDI	AFB;AKE;AKN		06/97-09/02	7SBU16C	R134a	DCP02004	
2.5 TDI	AKN		11/97-12/98	7SBU16C	R134a	DCP02005	4B0260805B
2.5 TDI quattro	AFB;AKE;AKN		07/97-09/02	7SBU16C	R134a	DCP02004	
2.5 TDI quattro	AKN		03/98-12/98	7SBU16C	R134a	DCP02005	4B0260805B
2.8	AAH;ACK;AEJ;ALG;AMX;APR;AQD		07/95-09/02	7SBU16C	R134a	DCP02005	
2.8 quattro	AAH;ACK;AEJ;AMX;APR;AQD		03/94-09/02	7SBU16C	R134a	DCP02005	
3.3 TDI quattro	AKF		06/00-09/02	7SBU16C	R134a	DCP02004	4B0260805C
3.3 TDI quattro	AKF		06/00-09/02	7SBU16C	R134a	DCP02005	4B0260805B
3.7	AEW;AKC;AQQ		07/95-09/02	7SBU16C	R134a	DCP02005	4B0260805B
3.7	AQG		11/98-02/01	7SBU16C	R134a	DCP02004	4B0260805C
3.7 quattro	AEW;AKC;AKJ;AQQ		04/97-09/02	7SBU16C	R134a	DCP02005	4B0260805B
3.7 quattro	AQG		11/98-02/01	7SBU16C	R134a	DCP02004	4B0260805C
4.2 quattro	ABZ;AEM;AKG;AQF;ARU;AUW		03/94-09/02	7SBU16C	R134a	DCP02005	4B0260805B
4.2 S8 quattro	AHC;AKH;AQH;AVP;BCS		07/96-09/02	7SBU16C	R134a	DCP02005	
6.0 W12 quattro	AZC		01/01-09/02	7SEU16C	R134a	DCP02011	
<b>A8 (4E) (02-10)</b>							
2.8 FSI	BDX		08/07-07/10	7SEU17C	R134a	DCP02031	4E0260805AR
2.8 FSI	BDX		08/07-07/10	7SEU17C	R134a	DCP02033	
3.0	ASN		07/03-05/05	7SEU16C	R134a	DCP02022	4E0260805E
3.0	ASN		07/03-05/05	7SEU16C	R134a	DCP02025	4E0260805E
3.0	ASN;BBJ		07/03-05/06	7SEU17C	R134a	DCP02032	4E0260805AG
3.0	ASN;BBJ		07/03-05/06	7SEU17C	R134a	DCP02034	4E0260805AC
3.0 quattro	BBJ	Ch No: >4E-4-018 000	11/03-05/04	7SEU16C	R134a	DCP02025	
3.0 quattro	BBJ	Ch No: 4E-4-018 001>4E-6-022 000	11/03-05/04	7SEU17C	R134a	DCP02034	
3.0 TDI quattro	ASB;BNG		11/03-07/10	6SEU14C	R134a	DCP02035	
3.2 FSI	BPK		06/05-07/10	7SEU17C	R134a	DCP02031	4E0260805AR
3.2 FSI	BPK		03/06-07/10	7SEU17C	R134a	DCP02033	
3.2 FSI quattro	BPK		06/05-07/10	7SEU17C	R134a	DCP02031	4E0260805AR
3.2 FSI quattro	BPK		06/05-07/10	7SEU17C	R134a	DCP02033	
3.7 quattro	BFL		10/02-05/06	7SEU16C	R134a	DCP02009	
4.0 TDI quattro	ASE		05/03-07/05	7SEU16C	R134a	DCP02091	
4.2 FSI quattro	BVJ		06/06-10/07	7SEU16C	R134a	DCP02009	4E0260805F
4.2 FSI quattro	BVJ		06/06-07/10	7SEU17C	R134a	DCP02064	8K0260805H
4.2 FSI quattro	BVJ		09/07-07/10	7SEU17C	R134a	DCP02015	4E0260805AS
4.2 quattro	BFM		10/02-05/06	7SEU16C	R134a	DCP02009	
4.2 TDI quattro	BMC;BVN		01/05-08/05	7SEU16C	R134a	DCP02091	
4.2 TDI quattro	BVN		07/05-07/10	6SEU14C	R134a	DCP02063	4E0260805AK
5.2 S8 quattro	BSM		06/06-07/10	7SEU17C	R134a	DCP02015	
5.2 S8 quattro	BSM		06/06-07/10	7SEU17C	R134a	DCP02064	8K0260805H
<b>A8 (4H) (09-18)</b>							
3.0 TDI	CLAB		09/11-09/13	6SEU14C	R134a	DCP02095	
3.0 TDI quattro	CDTA;CDTB;CDTC;CMHA;CPNA;CTBA;CTB B		07/10-01/18	6SEU14C	R134a	DCP02095	
3.0 TFSI quattro	CGWA;CGWD;CGXA;CGXC;CMDA;CREA;C REC; CREG;CTDA;CTUB		06/10-01/18	7SEU17C	R134a	DCP02032	4E0260805AG
3.0 TFSI quattro	CGWA;CGWD;CGXA;CGXC;CREA;CREG;CT UB		06/10-01/18	7SEU17C	R134a	DCP02034	
4.0 S8 quattro	CGTA; CTFA		04/12-01/18	6SEU14C	R134a	DCP02107	
4.0 TFSI quattro	CEUA;CTGA		03/12-12/15	6SEU14C	R134a	DCP02107	
4.2 FSI quattro	CDRA		11/09-06/12	6SEU14C	R134a	DCP32062	
4.2 TDI quattro	CDSB;CTEC		11/09-01/18	6SEU14C	R134a	DCP32071	
<b>ALLROAD (4BH) (00-05)</b>							
2.5 TDI quattro	AKE		05/00-05/03	7SBU16C	R134a	DCP02047	4Z0260805
2.5 TDI quattro	BAU;BCZ		05/03-08/05	6SEU12C	R134a	DCP02013	4B0260805J
2.7 T quattro	ARE; BES		05/00-08/05	7SBU16C	R134a	DCP02005	4B0260805B
4.2 V8 quattro	BAS		07/02-12/03	7SEU17C	R134a	DCP02055	
<b>CABRIOLET (8G7) (91-00)</b>							
2.3 E	NG	Ch No: >8GN002970	05/91-07/94	10P17C	R12 (Retrofit to R134a necessar y!)	DCP02001	

				TYPE	GAS	DENSO PN	OE
<b>AUDI Continued</b>							
<b>COUPE (81, 85) (80-88)</b>							
2.2 GT	KV		09/84-10/88	10P17C	R12 (Retrofit to R134a necessary!)	DCP02001	
<b>COUPE (89, 8B) (88-96)</b>							
1.8	DZ		08/89-07/91	10P17C	R12 (Retrofit to R134a necessary!)	DCP02001	
2.0	3A;AAD		08/89-07/91	10P17C	R12 (Retrofit to R134a necessary!)	DCP02001	034260805D
2.0 20 V	NM		08/89-07/91	10P17C	R12 (Retrofit to R134a necessary!)	DCP02001	
2.0 20 V quattro	NM		08/89-07/91	10P17C	R12 (Retrofit to R134a necessary!)	DCP02001	
2.2 quattro	KV		11/88-07/91	10P17C	R12 (Retrofit to R134a necessary!)	DCP02001	
2.2 S2 quattro	3B	Ch No: >88P002761	09/90-09/92	10P17C	R12 (Retrofit to R134a necessary!)	DCP02001	034260805D
2.3	NG		10/88-07/94	10P17C	R12 (Retrofit to R134a necessary!)	DCP02001	
2.3 20V	7A		08/89-07/91	10P17C	R12 (Retrofit to R134a necessary!)	DCP02001	
2.3 20V quattro	7A		11/88-07/91	10P17C	R12 (Retrofit to R134a necessary!)	DCP02001	
2.3 quattro	NG	Ch No: >88M020000	11/88-12/96	10P17C	R12 (Retrofit to R134a necessary!)	DCP02001	034260805D
<b>Q2 (GAB) (16-)</b>							
1.0 TFSI	CHZJ		10/16-	6SES14C	R134a; R1234yf	DCP32080	
1.4 TFSI	CZEA		06/16-	6SES14C	R134a; R1234yf	DCP32080	
1.6 TDI	DDYA		06/16-10/18	6SES14C	R134a; R1234yf	DCP32080	
2.0 TDI	DFGA		09/16-	6SES14C	R134a; R1234yf	DCP32080	
2.0 TDI quattro	DFGA;DFHA		07/16-	6SES14C	R134a; R1234yf	DCP32080	
<b>Q3 (8U) (11-18)</b>							
1.4 TFSI	CZDB		07/16-10/18	6SES14C	R134a	DCP32060	
1.4 TSI	CHPB; CZDA; CZEA		10/13-05/15	6SEU14C	R134a	DCP02050	
1.4 TSI	CHPB; CZDA; CZEA		06/15-10/18	6SES14C	R134a	DCP32060	
2.0 TDI	CFFA;CFFB;CLJA;CUVB;CUVC;DBBA;DFTA; DFTB		09/11-10/18	6SEU14C	R134a	DCP02050	
2.0 TDI	CFGC	For cold climates	06/11-04/15	6SEU14C	R134a	DCP02050	
2.0 TDI	CFGC	For mild climate zones; For hot climates	06/11-04/15	7SEU17C	R134a	DCP32045	
2.0 TDI	CUVC;CUVD;CUWA;DBBA;DFTA;DFTC;DFUA		06/15-10/18	6SES14C	R134a	DCP32060	
2.0 TDI quattro	CFFB;CFGC;CFGD;CLLB;CUVC;CUWA;CYLA; DFTA;DFUA		06/11-10/18	6SEU14C	R134a	DCP02050	



				TYPE	GAS	DENSO PN	OE
<b>AUDI</b> <i>Continued</i>							
<b>Q3 (8U) (11-18)</b> <i>Continued</i>							
2.0 TDI quattro	CUVC;CUWA;CYLA;DFTA;DFUA		06/15-10/18	6SES14C	R134a	DCP32060	
2.0 TFSI	CULB		06/15-10/18	6SES14C	R134a	DCP32060	
2.0 TFSI quattro	CCZC;CPSA;CULB;CULC		06/11-05/15	6SEU14C	R134a	DCP02050	
2.0 TFSI quattro	CULB;CULC		06/15-10/18	6SES14C	R134a	DCP32060	
<b>Q5 (8R) (08-)</b>							
2.0 TDI	CJCA;CJCB;CJCD;CSUA;CSUB		06/12-05/17	6SAS14C	R134a	DCP02098	
2.0 TDI	CJCA;CJCB;CSUB		11/10-09/12	6SEU14C	R134a	DCP02042	
2.0 TDI	CJCA;CJCB;CSUB		11/10-09/12	6SEU14C	R134a	DCP02060	8KD260805
2.0 TDI quattro	CAGA;CAGB;CAHA;CAHB;CGLA;CGLB;CGLD; CJCA;CJCB;CMGA;CNHC;CSUB		11/08-09/12	6SEU14C	R134a	DCP02060	8KD260805
2.0 TDI quattro	CAGA;CAGB;CAHA;CAHB;CGLA;CGLB;CJCA; CJCB;CMGA		11/08-09/12	6SEU14C	R134a	DCP02042	
2.0 TDI quattro	CGLC;CGLD;CJCA;CJCB;CJCD;CMGB;CNHA; CSUA		06/12-05/17	6SAS14C	R134a	DCP02098	
2.0 TFSI hybrid quattro	CHJA		06/11-06/16	6SEU14C	R134a	DCP02097	
2.0 TFSI quattro	CAEB;CDNB;CDNC		11/08-09/12	6SEU14C	R134a	DCP02042	
2.0 TFSI quattro	CAEB;CDNB;CDNC;CNCB;CPMA		11/08-09/12	6SEU14C	R134a	DCP02060	8KD260805
2.0 TFSI quattro	CNCB;CNCD;CNCE;CPMA;CPMB		06/12-05/17	6SEU14C	R134a	DCP02097	8T0260805N
3.0 SQ5 TDI quattro	CGQB;CVUB;CVUC;DEHA		12/12-05/17	6SES14C	R134a	DCP02102	
3.0 SQ5 TFSI quattro	CTUD; CTXA		05/13-05/17	6SES14C	R134a	DCP02105	
3.0 TDI quattro	CCWA;CCWB;CPNB		11/08-09/12	6SEU14C	R134a	DCP02092	
3.0 TDI quattro	CDUD;CTBA;CTBC		06/12-05/17	6SES14C	R134a	DCP02102	
3.0 TFSI quattro	CTUC; CTVA		06/12-05/17	6SES14C	R134a	DCP02105	
3.2 FSI quattro	CAKA		11/08-03/12	6SEU14C	R134a	DCP02043	
3.2 FSI quattro	CALB		03/12-12/12	6SES14C	R134a	DCP02105	
<b>Q7 (4L) (06-15)</b>							
3.0 TDI quattro	BUG;BUN;CASA;CASB;CATA;CCMA;CJGA		03/06-05/10	7SEU17C	R134a	DCP32022	
3.0 TDI quattro	CATA;CCMA;CJGA;CJGC;CJMA;CNRB;CRCA		05/10-08/15	7SEU17C	R134a	DCP02096	
3.0 TFSI quattro	CJTB;CJTC;CJWB;CJWC;CJWE;CNAA;CTWA; CTWB		05/10-08/15	7SEU17C	R134a	DCP02031	4E0260805AR
3.0 TFSI quattro	CJTB;CJTC;CJWB;CJWC;CJWE;CNAA;CTWA; CTWB		05/10-08/15	7SEU17C	R134a	DCP02033	
3.6 FSI quattro	BHK		08/06-05/10	7SEU17C	R134a	DCP32031	
3.6 FSI quattro	BHK		08/06-05/10	7SEU17C	R134a	DCP32055	7P0820803E
4.2 FSI quattro	BAR		03/06-05/10	7SEU17C	R134a	DCP02015	
4.2 FSI quattro	BAR		03/06-05/10	7SEU17C	R134a	DCP02064	8K0260805H
4.2 TDI quattro	BTR;CCFA;CCFC		03/07-08/15	6SEU14C	R134a	DCP02063	
6.0 TDI quattro	CCGA		09/08-05/14	7SEU17C	R134a	DCP32063	
<b>Q7 (4M) (15-)</b>							
2.0 TFSI quattro	CYMC; CYRB		08/15-	6SES14C	R134a; R1234yf	DCP02106	
<b>R8 (42) (07-15)</b>							
4.2 FSI quattro	BYH;CNDA		04/07-07/15	7SEU17C	R134a	DCP02104	
5.2 FSI quattro	BUJ;CMPA;CTPA;CTPB;CTYA		04/09-07/15	7SEU17C	R134a	DCP02104	
<b>TT (8J) (06-14)</b>							
1.8 TFSI	CDA	For cold climates;For mild climate zones	06/08-06/14	6SEU14C	R134a	DCP02050	
1.8 TFSI	CDA	For hot climate zones	06/08-06/14	7SEU17C	R134a	DCP32045	
2.0 TDI quattro	CBBB;CFGB		06/08-06/14	6SEU14C	R134a	DCP02050	
2.0 TFSI	BPY; BWA; CCTA		03/07-06/10	6SEU14C	R134a	DCP02030	
2.0 TFSI	BPY; BWA; CCTA	For cold climates;For mild climate zones	08/06-06/10	6SEU14C	R134a	DCP02030	
2.0 TFSI	BPY; BWA; CCTA	For hot climate zones	08/06-06/10	7SEU17C	R134a	DCP32045	
2.0 TFSI	CESA	Ch No: 06FD>	05/10-06/14	6SEU14C	R134a	DCP02030	
2.0 TFSI	CESA	Ch No: 06JE>	05/10-06/14	6SEU14C	R134a	DCP02050	
2.0 TFSI quattro	BWA;CCZA	For cold climates;For mild climate zones	06/08-06/10	6SEU14C	R134a	DCP02050	
2.0 TFSI quattro	BWA;CCZA	For hot climate zones	06/08-06/10	7SEU17C	R134a	DCP32045	
2.0 TFSI quattro	CESA;CETA	Ch No: 06FD>	05/10-06/14	6SEU14C	R134a	DCP02030	
2.0 TFSI quattro	CESA;CETA	Ch No: 06JE>	05/10-06/14	6SEU14C	R134a	DCP02050	





				TYPE	GAS	DENSO PN	OE
<b>AUDI</b> <i>Continued</i>							
<b>TT (8J) (06-14)</b> <i>Continued</i>							
2.0 TTS quattro	CDLA	For cold climates;For mild climate zones	05/08-06/14	6SEU14C	R134a	DCP02030	
2.0 TTS quattro	CDLA	For cold climates;For mild climate zones	05/08-06/14	6SEU14C	R134a	DCP02050	
2.0 TTS quattro	CDLA	For hot climate zones	05/08-06/14	7SEU17C	R134a	DCP32045	
2.0 TTS quattro	CDLB		05/08-06/14	6SEU14C	R134a	DCP02030	1K0820859T;1K0820859N;1K0820859J
2.0 TTS quattro	CDLB		05/08-06/14	6SEU14C	R134a	DCP02050	1K0820808A;1K0820859P;1K0820859H
3.2 V6 quattro	BUB		08/06-06/10	6SEU14C	R134a	DCP02030	
<b>TT (FV) (14-)</b>							
1.8 TFSI	CJSA;CJSB		08/15-	6SES14C	R134a	DCP32060	
2.0 TDI	CUNA		07/14-	6SES14C	R134a	DCP32060	
2.0 TFSI	CHHC		07/14-	6SES14C	R134a	DCP32060	
2.0 TFSI quattro	CHHC		07/14-	6SES14C	R134a	DCP32060	
2.0 TTS quattro	CJXF;CJXG		11/14-	6SES14C	R134a	DCP32060	
<b>V8 (44, 4C) (88-94)</b>							
3.6 quattro	PT		10/88-08/91	10P17C	R12 (Retrofit to R134a necessary)	DCP02003	
<b>BENTLEY</b>							
<b>CONTINENTAL (03-)</b>							
6.0	BEB		06/03-11/06	7SEU16C	R134a	DCP32052	3B0820803C
<b>BMW</b>							
<b>1 (E81, E87) (03-12)</b>							
116 d	N47 D20 A; N47 D20 C		11/08-12/11	6SBU14C	R134a	DCP05050	
116 d	N47 D20 A; N47 D20 C	S1CBA- (CO2)	03/09-06/11	6SEU14C	R134a	DCP05061	64526987863
116 d	N47 D20 A; N47 D20 C	S1CBA+ (CO2)	03/09-06/11	6SBU14C	R134a	DCP05050	64526987862
118 d	N47 D20 A; N47 D20 C		09/04-02/07	5SE12C	R134a	DCP05026	
118 d	N47 D20 A;N47 D20 C		01/07-12/11	6SEU14C	R134a	DCP05061	
118 d	N47 D20 C	For vehicles with automatic climate control	03/07-06/11	6SEU14C	R134a	DCP05061	64526987863
118 d	N47 D20 C	Heavy duty version, For vehicles with automatic climate control	03/07-06/11	6SBU14C	R134a	DCP05050	64526987862
118 d	N47 D20 C	S1CBA- (CO2), For vehicles with automatic climate control	03/07-06/11	6SEU14C	R134a	DCP05061	64526987863
118 d	N47 D20 C	S1CBA+ (CO2), For vehicles with automatic climate control	03/07-06/11	6SBU14C	R134a	DCP05050	64526987862
120 d	M47 D20 (204D4)		06/04-02/07	5SE12C	R134a	DCP05026	64526987766
120 d	N47 D20 A; N47 D20 C		03/07-12/11	6SBU14C	R134a	DCP05050	64526987862
120 d	N47 D20 A;N47 D20 C;N47D2000		03/07-12/11	6SEU14C	R134a	DCP05061	
120 d	N47D2000	Heavy duty version	03/07-06/11	6SBU14C	R134a	DCP05050	64526987862
123 d	N47 D20 B; N47 D20 D		03/07-12/11	6SBU14C	R134a	DCP05050	64526987862
123 d	N47 D20 B;N47 D20 D		03/07-12/11	6SEU14C	R134a	DCP05061	64526987863
130 i	N52 B30 A;N52 B30 AF;N52 B30 B; N52 B30 BF	S1CBA- (CO2)	09/05-06/11	7SEU17C	R134a	DCP05036	65529122618
130 i	N52 B30 A;N52 B30 AF;N52 B30 B; N52 B30 BF	S1CBA+ (CO2)	03/07-06/11	7SBU17C	R134a	DCP05093	64509180549
130 i	N52 B30 A;N52 B30 B;N52 B30 BF		09/06-12/11	7SEU17C	R134a	DCP05036	
<b>1 (F20, F21) (10-)</b>							
114 d 1.6	N47 D16 A		07/12-	6SEU14A	R134a	DCP05099	
114 i 1.6	N13 B16 A	P7HSA(-)	12/11-	6SEU14C	R134a	DCP05098	64529222308
114 i 1.6	N13 B16 A	P7HSA(+)	12/11-	6SBU14C	R134a	DCP05104	64529222296
116 d 1.5	B37 D15 A		03/15-	6SBU14A	R134a	DCP05095	
116 d 1.6	N47 D16 A		12/11-	6SEU14A	R134a	DCP05099	
116 d 2.0	N47 D20 C		07/11-	6SEU14A	R134a	DCP05099	
116 i 1.6	N13 B16 A		07/11-02/15	6SEU14C	R134a	DCP05098	
116 i 1.6	N13 B16 A	P7HSA(-)	12/11-	6SEU14C	R134a	DCP05098	64529222308
116 i 1.6	N13 B16 A	P7HSA(+)	12/11-	6SBU14C	R134a	DCP05104	64529222296





				TYPE	GAS	DENSO PN	OE
<b>BMW Continued</b>							
<b>1 (F20, F21) (10-) Continued</b>							
118 d	N47 D20 C		07/11-	6SBU14A	R134a	DCP05095	
118 i 1.6	N13 B16 A		07/11-	6SEU14C	R134a	DCP05098	
118 i 1.6	N13 B16 A	For vehicles with automatic climate control	03/15-	6SEU14C	R134a	DCP05098	
118 xd	N47 D20 C		05/13-02/15	6SBU14A	R134a	DCP05095	
120 d	B47 D20 A;N47 D20 C	S1CBA- (CO2)	07/11-02/14	6SEU14A	R134a	DCP05099	
120 d	B47 D20 A;N47 D20 C	S1CBA- (CO2)	02/14-	6SEU14A	R134a	DCP05105	
120 d	B47 D20 A;N47 D20 C	S1CBA+ (CO2)	07/11-02/14	6SBU14A	R134a	DCP05095	
120 d	B47 D20 A;N47 D20 C	S1CBA+ (CO2)	02/14-	6SBU14A	R134a	DCP05106	
120 i 1.6	N13 B16 A	For vehicles with automatic climate control	03/15-	6SEU14C	R134a	DCP05098	
120 xd	B47 D20 A;N47 D20 C	S1CBA- (CO2)	02/14-	6SEU14A	R134a	DCP05105	
120 xd	B47 D20 A;N47 D20 C	S1CBA+ (CO2)	02/14-	6SBU14A	R134a	DCP05106	
120 xd	N47 D20 C	S1CBA- (CO2)	01/12-02/14	6SEU14A	R134a	DCP05099	
120 xd	N47 D20 C	S1CBA+ (CO2)	01/12-02/14	6SBU14A	R134a	DCP05095	
125 d	B47 D20 B;N47 D20 D		03/12-	6SEU14A	R134a	DCP05099	
125 i	N20 B20 A		12/11-	7SEU17A	R134a	DCP05097	64529216467
125 i	N20 B20 A	For hot climate zones	12/11-	6SEU14A	R134a	DCP05099	64529223695
125 i	B48 B20 B		10/15-	7SEU17A	R134a	DCP05114	64529330827
M 135 i	N55 B30 A		12/11-	7SEU17C	R134a	DCP05090	
M 135 xi	N55 B30 A		02/12-	7SEU17C	R134a	DCP05090	
<b>1 Coupe/Convertible (E82, E88) (07-13)</b>							
118 d	N47 D20 A; N47 D20 C		09/08-12/13	6SEU14C	R134a	DCP05061	64526987863
118 d	N47 D20 A;N47 D20 C		09/08-12/13	6SBU14C	R134a	DCP05050	
120 d	N47 D20 A;N47 D20 C		09/07-12/13	6SBU14C	R134a	DCP05050	64526987862
120 d	N47 D20 A;N47 D20 C		09/07-12/13	6SEU14C	R134a	DCP05061	64526987863
123 d	N47 D20 B;N47 D20 D		10/07-12/13	6SEU14C	R134a	DCP05061	64526987863
123 d	N47 D20 B;N47 D20 D		09/08-12/13	6SBU14C	R134a	DCP05050	64526987862
125 i	N52 B30 A	S1CBA- (CO2)	03/08-12/13	7SEU17C	R134a	DCP05036	
125 i	N52 B30 A	S1CBA+ (CO2)	10/07-10/13	7SEU17C	R134a	DCP05036	
125 i	N52 B30 A	S1CBA+ (CO2)	10/07-12/13	7SBU17C	R134a	DCP05093	
135 i	N54 B30 A		10/07-10/13	7SEU17C	R134a	DCP05033	
M1	N54 B30 A		03/11-06/12	7SEU17C	R134a	DCP05033	
<b>2 Coupe/Convertible (F22, F23) (13-)</b>							
218 d	N47 D20 C	S1CBA- (CO2)	02/14-	6SEU14A	R134a	DCP05105	
218 d	N47 D20 C	S1CBA+ (CO2)	02/14-	6SBU14A	R134a	DCP05106	
220 d	B47 D20 A;N47 D20 C	S1CBA- (CO2)	10/12-	6SEU14A	R134a	DCP05105	
220 i	N20 B20 A;N20 B20 B	For cold climates;For mild climate zones	10/13-	6SBU14A	R134a	DCP05106	
220 i	B48 B20 A		09/15-	7SEU17A	R134a	DCP05114	64529330827
225 d	N47 D20 D	S1CBA- (CO2)	01/14-	6SEU14A	R134a	DCP05105	
228 i	N20 B20 A		11/14-	7SBU17A	R134a	DCP05115	
228 i	N20 B20 A; N26 B20 A	S1CBA- (CO2)	07/14-	6SEU14A	R134a	DCP05105	
<b>3 (E36) (90-00)</b>							
316 i 1.6	M40 B16 (164E1)		03/91-08/93	10PA17C	R134a	DCP05007	
316 i 1.6	M43 B16 (164E2)		05/96-05/99	10PA17C	R134a	DCP05003	
318 i	M40 B18 (184E1)		09/90-08/93	10PA17C	R134a	DCP05007	
318 is 1.8	M42 B18 (184S1)		01/92-03/94	10PA17C	R134a	DCP05007	64528391693
318 is 1.9	M44194S1		09/95-04/99	10PA17C	R134a	DCP05007	64528391693
320 i	M50 B20 (206S1);M50 B20 (206S2); M52 B20 (206S3)		01/91-11/99	10PA17C	R134a	DCP05003	
320 i	M52 B20	Japan;Australia	06/94-02/98	10PA17C	R134a	DCP05003	64528390741
323 i	M52 B25 (256S3)		05/95-11/99	10PA17C	R134a	DCP05003	
323 ti	M52 B25 (256S3)		09/97-08/00	10PA17C	R134a	DCP05003	
325 i	M50 B25 (256S1);M50 B25 (256S2)		09/90-12/95	10PA17C	R134a	DCP05003	
325 td	M51 D25 (256T1)		09/91-02/98	10PA17C	R134a	DCP05004	64528391135
325 td	M51 D25 (256T1)		03/93-02/98	10PA17C	R134a	DCP05010	64528371021
325 tds	M51 D25 (256T1)		05/93-04/99	10PA17C	R134a	DCP05004	64528391135
325 tds	M51 D25 (256T1)		05/93-04/99	10PA17C	R134a	DCP05010	64528371021
325 tds	M51 D25 (256T1)		05/96-04/99	10PA17C	R134a	DCP05007	64528391693
328 i	M52 B28 (286S1)		01/95-11/99	10PA17C	R134a	DCP05003	
M3 3.0	S50 B30 (306S1)		10/94-07/95	10PA17C	R134a	DCP05003	
M3 3.2	S50 B32 (326S1)		10/95-01/98	10PA17C	R134a	DCP05003	
<b>3 (E46) (98-06)</b>							
318 Ci 2.0	N42 B20 A;N46 B20 A;N46 B20 B		09/01-12/07	7SBU16C	R134a	DCP05014	64526910458
318 Ci 2.0	N42 B20 A;N46 B20 A;N46 B20 B		09/01-12/07	7SBU16C	R134a	DCP05039	64526916232





				TYPE	GAS	DENSO PN	OE
<b>BMW Continued</b>							
<b>3 (E46) (98-06) Continued</b>							
318 Ci 2.0	N42 B20 A;N46 B20 A;N46 B20 B			09/01-12/07	7SBU16C	R134a DCP05040	64526915388
320 Ci 2.0	M52 B20 (206S4)			02/99-08/01	7SBU16C	R134a DCP05014	64526910458
320 Ci 2.0	M52 B20 (206S4)			02/99-08/01	7SBU16C	R134a DCP05039	64526916232
320 Ci 2.0	M52 B20 (206S4)			02/99-08/01	7SBU16C	R134a DCP05040	64526915388
320 Ci 2.2	M54 B22 (226S1)			01/00-12/07	7SBU16C	R134a DCP05014	64526910458
320 Ci 2.2	M54 B22 (226S1)			01/00-12/07	7SBU16C	R134a DCP05039	64526916232
320 Ci 2.2	M54 B22 (226S1)			01/00-12/07	7SBU16C	R134a DCP05040	64526915388
320 i 2.0	M52 B20 (206S4)			03/98-03/00	7SBU16C	R134a DCP05014	64526910458
320 i 2.0	M52 B20 (206S4)			03/98-03/00	7SBU16C	R134a DCP05039	64526916232
320 i 2.0	M52 B20 (206S4)			03/98-09/00	7SBU16C	R134a DCP05040	64526915388
320 i 2.2	M54 B22 (226S1)			09/00-02/05	7SBU16C	R134a DCP05040	64526915388
320 i 2.2	M54 B22 (226S1)			09/01-02/05	7SBU16C	R134a DCP05014	64526910458
320 i 2.2	M54 B22 (226S1)			09/01-02/05	7SBU16C	R134a DCP05039	64526916232
323 Ci	M52 B25 (256S4)			04/99-09/00	7SBU16C	R134a DCP05014	64526910458
323 Ci	M52 B25 (256S4)			04/99-09/00	7SBU16C	R134a DCP05039	64526916232
323 Ci	M52 B25 (256S4)			04/99-09/00	7SBU16C	R134a DCP05040	64526915388
323 i	M52 B25 (256S4)			03/98-03/00	7SBU16C	R134a DCP05014	64526910458
323 i	M52 B25 (256S4)			03/98-03/00	7SBU16C	R134a DCP05039	64526916232
323 i	M52 B25 (256S4)			03/98-09/00	7SBU16C	R134a DCP05040	64526915388
325 Ci	M54 B25 (256S5)			09/00-05/06	7SBU16C	R134a DCP05014	64526910458
325 Ci	M54 B25 (256S5)			09/00-05/06	7SBU16C	R134a DCP05039	64526916232
325 Ci	M54 B25 (256S5)			09/00-08/06	7SBU16C	R134a DCP05040	64526915388
325 i	M54 B25 (256S5)			09/00-02/05	7SBU16C	R134a DCP05040	64526915388
325 i	M54 B25 (256S5)			09/01-02/05	7SBU16C	R134a DCP05014	64526910458
325 i	M54 B25 (256S5)			09/01-02/05	7SBU16C	R134a DCP05039	64526916232
325 ti	M54 B25 (256S5)			04/01-12/04	7SBU16C	R134a DCP05014	64526910458
325 ti	M54 B25 (256S5)			04/01-12/04	7SBU16C	R134a DCP05039	64526916232
325 ti	M54 B25 (256S5)			04/01-12/04	7SBU16C	R134a DCP05040	64526915388
325 xi	M54 B25 (256S5)			09/00-02/05	7SBU16C	R134a DCP05040	64526915388
325 xi	M54 B25 (256S5)			09/01-02/05	7SBU16C	R134a DCP05014	64526910458
325 xi	M54 B25 (256S5)			09/01-02/05	7SBU16C	R134a DCP05039	64526916232
328 Ci	M52 B28 (286S2)			12/98-05/00	7SBU16C	R134a DCP05014	64526910458
328 Ci	M52 B28 (286S2)			12/98-05/00	7SBU16C	R134a DCP05039	64526916232
328 Ci	M52 B28 (286S2)			12/98-05/00	7SBU16C	R134a DCP05040	64526915388
328 i	M52 B28 (286S2)			02/98-06/00	7SBU16C	R134a DCP05014	64526910458
328 i	M52 B28 (286S2)			02/98-06/00	7SBU16C	R134a DCP05039	64526916232
328 i	M52 B28 (286S2)			02/98-06/00	7SBU16C	R134a DCP05040	64526915388
330 Cd	M57 D30 (306D2)			03/03-07/06	7SBU16C	R134a DCP05040	64526915388
330 Cd	M57 D30 (306D2)			07/03-05/06	7SBU16C	R134a DCP05014	64526910459
330 Cd	M57 D30 (306D2)			07/03-12/07	7SBU16C	R134a DCP05039	64526915388
330 Ci	M54 B30 (306S3)			06/00-08/06	7SBU16C	R134a DCP05014	64526910458
330 Ci	M54 B30 (306S3)			06/00-08/06	7SBU16C	R134a DCP05039	64526916232
330 Ci	M54 B30 (306S3)			06/00-08/06	7SBU16C	R134a DCP05040	64526915388
330 d 2.9	M57 D30 (306D1)			10/99-02/03	7SBU16C	R134a DCP05014	
330 d 3.0	M57 D30 (306D2)			03/03-02/05	7SBU16C	R134a DCP05014	64526910459
330 d 3.0	M57 D30 (306D2)			03/03-02/05	7SBU16C	R134a DCP05039	
330 d 3.0	M57 D30 (306D2)			03/03-02/05	7SBU16C	R134a DCP05040	64526915388
330 i	M54 B30 (306S3)			06/00-02/05	7SBU16C	R134a DCP05014	64526910458
330 i	M54 B30 (306S3)			06/00-02/05	7SBU16C	R134a DCP05040	64526915388
330 i	M54 B30 (306S3)			06/00-04/05	7SBU16C	R134a DCP05039	64526916232
330 xd 2.9	M57 D30 (306D1)			10/00-02/03	7SBU16C	R134a DCP05014	
330 xd 3.0	M57 D30 (306D2)			08/02-05/05	7SBU16C	R134a DCP05014	64526910459
330 xd 3.0	M57 D30 (306D2)			08/02-05/05	7SBU16C	R134a DCP05039	
330 xd 3.0	M57 D30 (306D2)			08/02-05/05	7SBU16C	R134a DCP05040	64526915388
330 xi	M54 B30 (306S3)			06/00-02/05	7SBU16C	R134a DCP05014	64526910458
330 xi	M54 B30 (306S3)			06/00-02/05	7SBU16C	R134a DCP05039	64526916232
330 xi	M54 B30 (306S3)			06/00-07/06	7SBU16C	R134a DCP05040	64526915388
M3	S54 B32 (326S4)			07/00-08/06	7SBU16C	R134a DCP05040	64526915388
M3	S54 B32 (326S4);S54B32			07/00-07/06	7SBU16C	R134a DCP05039	64526916232
M3	S54B32			07/00-12/02	7SBU16C	R134a DCP05014	64526910458
<b>3 (E90, E91) (05-12)</b>							
316 d	N47 D20 C			07/09-12/11	6SBU14C	R134a DCP05050	
316 d	N47 D20 C			09/09-06/12	6SBU14A	R134a DCP05095	64529225703
318 d	M47 D20 (204D4)			03/05-08/07	5SE12C	R134a DCP05026	
318 d	N47 D20 A			02/07-09/08	6SEU14C	R134a DCP05061	64526987863
318 d	N47 D20 A;N47 D20 C			09/08-06/12	6SBU14C	R134a DCP05050	64526987862











				TYPE	GAS	DENSO PN	OE
<b>BMW Continued</b>							
<b>3 (E90, E91) (05-12) Continued</b>							
318 d	N47 D20 C	For vehicles with air conditioning (manually controlled)	09/09-06/12	6SEU14A	R134a	DCP05091	64529225704
318 d	N47 D20 C	For vehicles with automatic climate control	09/09-06/12	6SBU14C	R134a	DCP05050	64526987862
318 d	N47 D20 C	Heavy duty version	09/09-06/12	6SBU14A	R134a	DCP05095	64529223694
318 d	N47 D20 C	S1CBA- (CO2)	02/07-10/11	6SEU14A	R134a	DCP05091	64529225704
318 d	N47 D20 C	S1CBA+ (CO2)	02/07-10/11	6SBU14A	R134a	DCP05095	64529223694
318 i	N43 B20 A		05/07-05/12	6SBU14C	R134a	DCP05050	
320 d	M47 D20 (204D4)		12/04-06/12	5SE12C	R134a	DCP05026	64526987766
320 d	M47 D20 (204D4);N47 D20 A;N47 D20 C		12/04-05/12	6SBU14C	R134a	DCP05050	64526987862
320 d	N47 D20 A;N47 D20 C		02/07-09/08	6SEU14C	R134a	DCP05061	64526987863
320 d	N47 D20 C	S1CBA- (CO2)	10/09-10/11	6SEU14A	R134a	DCP05091	64529225704
320 d	N47 D20 C	S1CBA+ (CO2)	10/09-10/11	6SBU14A	R134a	DCP05095	64529223694
320 xd	N47 D20 A;N47 D20 C		09/08-06/12	6SBU14C	R134a	DCP05050	
323 i	N52 B25 A		04/06-06/07	7SEU17C	R134a	DCP05045	
323 i	N52 B25 A; N52 B25 B; N52 B25 BE; N52 B25 BF		09/05-02/07	7SEU17C	R134a	DCP05036	
323 i	N52 B25 A; N52 B25 BF	S1CBA- (CO2)	03/07-12/11	7SEU17C	R134a	DCP05036	64529122618
323 i	N52 B25 A; N52 B25 BF	S1CBA+ (CO2)	03/07-12/11	7SBU17C	R134a	DCP05093	64509180549
325 d	M57 D30 (306D3)		09/06-09/08	7SEU17C	R134a	DCP05037	64526924792
325 d	M57 D30 (306D3);N57 D30 A		09/08-06/12	6SBU14C	R134a	DCP05050	64526987862
325 i 2.5	N52 B25 A;N52 B25 B;N52 B25 BF		12/04-09/06	7SEU17C	R134a	DCP05045	
325 i 2.5	N52 B25 A;N52 B25 B;N52 B25 BF	S1CBA- (CO2)	10/06-12/11	7SEU17C	R134a	DCP05036	
325 i 2.5	N52 B25 A;N52 B25 B;N52 B25 BF	S1CBA+ (CO2)	10/06-12/11	7SBU17C	R134a	DCP05093	
325 i 3.0	N53 B30 A		03/07-12/11	7SBU17C	R134a	DCP05093	
325 i 3.0	N53 B30 A	S1CBA+ (CO2)	09/07-06/12	7SBU17C	R134a	DCP05093	
325 xi 2.5	N52 B25 A		03/05-09/06	7SEU17C	R134a	DCP05045	
325 xi 2.5	N52 B25 A	S1CBA- (CO2)	10/06-10/11	7SEU17C	R134a	DCP05036	
325 xi 2.5	N52 B25 A	S1CBA+ (CO2)	10/06-10/11	7SBU17C	R134a	DCP05093	
325 xi 3.0	N53 B30 A		03/07-06/12	7SBU17C	R134a	DCP05093	
325 xi 3.0	N53 B30 A	S1CBA+ (CO2)	09/07-08/08	7SBU17C	R134a	DCP05093	
330 d	M57 D30 (306D3)		12/04-09/08	7SEU17C	R134a	DCP05037	
330 d	N57 D30 A		02/08-05/12	6SBU14C	R134a	DCP05050	
330 i	N52 B30 A;N52 B30 BF		12/04-02/06	7SEU17C	R134a	DCP05045	64526956716
330 i	N52 B30 A;N52 B30 BF		03/06-10/11	7SEU17C	R134a	DCP05036	64529122618
330 i	N53 B30 A		09/07-06/12	7SBU17C	R134a	DCP05093	
330 xd	M57 D30 (306D3)		09/05-08/08	7SEU17C	R134a	DCP05037	
330 xd	N57 D30 A		09/08-06/12	6SBU14C	R134a	DCP05050	
330 xi	N52 B30 A		09/05-02/06	7SEU17C	R134a	DCP05045	64526956716
330 xi	N52 B30 A		03/06-08/07	7SEU17C	R134a	DCP05036	64529122618
330 xi	N53 B30 A		09/07-06/12	7SBU17C	R134a	DCP05093	
330 xi	N53 B30 A	S1CBA+ (CO2)	09/07-06/12	7SBU17C	R134a	DCP05093	
335 d	M57 D30 (306D5)		09/06-09/08	7SEU17C	R134a	DCP05092	
335 d	M57 D30 (306D5)		09/08-06/12	6SBU14C	R134a	DCP05050	
335 i	N54 B30 A;N55 B30 A		03/06-06/12	7SEU17C	R134a	DCP05033	
335 xi	N54 B30 A;N55 B30 A		03/07-06/12	7SEU17C	R134a	DCP05033	
M3	S65 B40 A		12/07-10/11	7SEU17C	R134a	DCP05079	
<b>3 (F30, F31) (11-19)</b>							
316 d	B47 D20 A;N47 D20 C		03/12-06/19	6SBU14A	R134a	DCP05095	
316 i	N13 B16 A		07/12-08/16	6SEU14C	R134a	DCP05098	
318 d	B47 D20 A; N47 D20 C		03/12-10/18	6SBU14A	R134a	DCP05095	
318 d	B47 D20 A;N47 D20 C	S1CBA- (CO2)	03/12-06/19	6SBU14A	R134a	DCP05095	
318 d	B47 D20 A;N47 D20 C	S1CBA+ (CO2)	03/12-06/19	6SEU14A	R134a	DCP05099	
318 d	N47 D20 C		11/12-06/15	6SEU14A	R134a	DCP05099	
318 xd	N47 D20 C		07/13-06/15	6SBU14A	R134a	DCP05095	
320 d	B47 D20 A;N47 D20 C		11/11-06/19	6SEU14A	R134a	DCP05099	
320 d	N47 D20 C		11/11-03/16	6SBU14A	R134a	DCP05095	
320 d	N47 D20 C	for vehicles with sports package	11/11-03/16	6SEU14A	R134a	DCP05099	64529223695
320 i 1.6	N13 B16 A		11/12-06/16	6SBU14C	R134a	DCP05104	
320 i 2.0	N20 B20 A; N20 B20 D		03/12-10/18	6SEU14A	R134a	DCP05099	64529223695
320 i 2.0	N20 B20 A; N20 B20 D	For hot climate zones	03/12-10/18	7SBU17A	R134a	DCP05096	64529216466
320 i 2.0	N20 B20 B	For hot climate zones	11/12-06/15	7SEU17A	R134a	DCP05097	





				TYPE	GAS	DENSO PN	OE
<b>BMW Continued</b>							
<b>3 (F30, F31) (11-19) Continued</b>							
320 xd	B47 D20 A; N47 D20 C	For vehicles with automatic climate control	08/12-10/18	6SEU14A	R134a	DCP05099	
320 xd	B47 D20 A;N47 D20 C		08/12-06/19	6SBU14A	R134a	DCP05095	
320 xd	B47 D20 A;N47 D20 C	for vehicles with sports package	08/12-06/19	6SEU14A	R134a	DCP05099	64529223695
320 xd	N47 D20 C		08/12-06/15	6SEU14A	R134a	DCP05099	
320 xi	N20 B20 A; N20 B20 B	For hot climate zones	07/12-10/18	7SEU17A	R134a	DCP05097	
320 xi	N20 B20 B		03/13-06/15	6SEU14A	R134a	DCP05099	64529223695
320 xi	N20 B20 B	For hot climate zones	03/13-06/15	7SBU17A	R134a	DCP05096	64529216466
325 d	N47 D20 D		03/13-02/16	6SEU14A	R134a	DCP05099	
325 d	N47 D20 D		10/15-02/16	6SEU14A	R134a	DCP05105	
328 i	N20B20A		04/11-10/18	6SEU14A	R134a	DCP05099	64529223695
328 i	N20B20A	For hot climate zones	04/11-10/18	7SBU17A	R134a	DCP05096	64529216466
328 xi	N20B20A		07/12-08/16	6SEU14A	R134a	DCP05099	64529223695
328 xi	N20B20A	For hot climate zones	07/12-08/16	7SBU17A	R134a	DCP05096	64529216466
330 d	N57 D30 A		07/12-10/18	6SEU14A	R134a	DCP05099	
330 d	N57 D30 A		07/12-06/19	7SEU17A	R134a	DCP05097	
330 d	N57 D30 A		09/15-06/19	6SEU14A	R134a	DCP05105	
330 xd	N57 D30 A		03/13-06/19	6SEU14A	R134a	DCP05099	
330 xd	N57 D30 A		09/15-06/19	6SEU14A	R134a	DCP05105	
335 i	N55 B30 A		11/11-09/15	7SEU17C	R134a	DCP05090	
335 i	N55 B30 A		01/13-06/15	7SBU17C	R134a	DCP05078	
335 xd	N57 D30 B	For hot climate zones	07/13-06/19	7SEU17A	R134a	DCP05097	
335 xd	N57 D30 B	not for hot climates	07/13-06/19	6SEU14A	R134a	DCP05099	
335 xi	N55 B30 A		07/12-07/15	7SBU17C	R134a	DCP05078	
335 xi	N55 B30 A		04/13-09/15	7SEU17C	R134a	DCP05090	
<b>3 Coupe/Convertible (E92, E93) (06-13)</b>							
318 i	N43 B20 A		03/10-12/13	6SBU14C	R134a	DCP05050	64526987862
320 d	N47 D20 A;N47 D20 C		09/06-02/10	6SEU14C	R134a	DCP05061	
320 d	N47 D20 A;N47 D20 C	S1CBA- (CO2)	03/07-12/13	6SEU14A	R134a	DCP05091	64529225704
320 d	N47 D20 A;N47 D20 C	S1CBA+ (CO2)	03/07-12/13	6SBU14A	R134a	DCP05095	64529223694
320 d	N47 D20 C	S1CBA- (CO2)	03/10-10/13	6SBU14C	R134a	DCP05050	64526987862
320 i	N43 B20 A		11/08-12/13	6SBU14C	R134a	DCP05050	64526987862
320 xd	N47 D20 C		09/08-02/10	6SEU14C	R134a	DCP05061	
320 xd	N47 D20 C	S1CBA- (CO2)	03/10-06/13	6SEU14A	R134a	DCP05091	
320 xd	N47 D20 C	S1CBA+ (CO2)	03/10-06/13	6SBU14A	R134a	DCP05095	
323 i	N52 B25 A	S1CBA- (CO2)	03/07-09/11	7SEU17C	R134a	DCP05036	
323 i	N52 B25 A	S1CBA+ (CO2)	03/07-09/11	7SBU17C	R134a	DCP05093	
325 d	M57 D30 (306D3)		02/07-12/10	7SEU17C	R134a	DCP05037	
325 d	N57 D30 A		09/09-12/13	6SBU14C	R134a	DCP05050	
325 i 2.5	N52 B25 A	S1CBA- (CO2)	12/06-02/10	7SEU17C	R134a	DCP05036	
325 i 2.5	N52 B25 A	S1CBA+ (CO2)	12/06-02/10	7SBU17C	R134a	DCP05093	
325 i 2.5	N52 B25 A; N52 B25 AF; N52 B25 BF		06/06-02/10	7SEU17C	R134a	DCP05036	
325 i 3.0	N53 B30 A		03/10-06/13	7SBU17C	R134a	DCP05093	
325 i 3.0	N53 B30 A	S1CBA- (CO2)	03/07-12/13	7SEU17C	R134a	DCP05036	
325 i 3.0	N53 B30 A	S1CBA- (CO2)	09/07-06/13	7SBU16C	R134a	DCP05031	64526918749
325 i 3.0	N53 B30 A	S1CBA+ (CO2)	03/07-12/13	7SBU17C	R134a	DCP05093	
325 xi 2.5	N52 B25 A		03/10-04/13	7SEU17C	R134a	DCP05036	
325 xi 2.5	N52 B25 A	S1CBA- (CO2)	09/06-02/10	7SEU17C	R134a	DCP05036	
325 xi 2.5	N52 B25 A	S1CBA+ (CO2)	09/06-02/10	7SBU17C	R134a	DCP05093	
325 xi 3.0	N53 B30 A	S1CBA- (CO2)	09/07-12/13	7SBU16C	R134a	DCP05031	64526918749
325 xi 3.0	N53 B30 A	S1CBA+ (CO2)	09/07-12/13	7SBU17C	R134a	DCP05093	64509180549
330 d	M57 D30 (306D3)		03/06-03/09	7SEU17C	R134a	DCP05037	
330 d	N57 D30 A		07/09-12/13	6SBU14C	R134a	DCP05050	
330 i	N52 B30 A;N52 B30 AF;N52 B30 BF; N53 B30 A	S1CBA- (CO2)	09/06-10/13	7SEU17C	R134a	DCP05036	
330 i	N52 B30 A;N52 B30 AF;N52 B30 BF; N53 B30 A	S1CBA+ (CO2)	09/06-10/13	7SBU17C	R134a	DCP05093	
330 xd	M57 D30 (306D3)		03/06-08/08	7SEU17C	R134a	DCP05037	
330 xd	N57 D30 A		03/08-02/10	6SEU14C	R134a	DCP05061	
330 xd	N57 D30 A		02/10-06/13	6SBU14C	R134a	DCP05050	
330 xi	N52 B30 A	S1CBA- (CO2)	09/06-08/07	7SEU17C	R134a	DCP05036	
330 xi	N53 B30 A		03/10-06/13	7SBU16C	R134a	DCP05031	64526918749
330 xi	N53 B30 A		03/10-06/13	7SBU17C	R134a	DCP05093	64509180549





				TYPE	GAS	DENSO PN	OE
<b>BMW Continued</b>							
<b>3 Coupe/Convertible (E92, E93) (06-13) Continued</b>							
335 d	M57 D30 (306D5)		03/06-03/13	7SBU17C	R134a	DCP05082	64509180547
335 d	M57 D30 (306D5)		03/06-03/13	7SEU17C	R134a	DCP05092	64509180548
335 i	N54 B30 A;N54 B30 B;N55 B30 A		06/06-10/13	7SEU17C	R134a	DCP05033	
335 xi	N54 B30 A;N55 B30 A		03/07-12/13	7SEU17C	R134a	DCP05033	
M3	S65 B40 A		06/07-10/13	7SEU17C	R134a	DCP05079	
<b>3 Gran Turismo (F34) (13-)</b>							
318 d	N47 D20 C		03/13-	6SBU14A	R134a	DCP05095	
318 d	N47 D20 C		03/13-	6SEU14A	R134a	DCP05099	
320 d	B47 D20 A; N47 D20 C	For hot climate zones	03/13-	7SBU17A	R134a	DCP05096	64529216466
320 d	B47 D20 A;N47 D20 C		03/13-	6SEU14A	R134a	DCP05099	
320 d	N47 D20 C		03/13-07/15	6SBU14A	R134a	DCP05095	
320 i	N20 B20 A; N20 B20 B		05/14-06/16	6SEU14A	R134a	DCP05099	
320 i	N20 B20 A; N20 B20 B	For hot climate zones	03/13-06/16	7SEU17A	R134a	DCP05097	
320 i	N20 B20 A; N20 B20 B	For hot climate zones	05/14-06/16	7SBU17A	R134a	DCP05096	
320 xd	B47 D20 A;N47 D20 C		03/13-	6SEU14A	R134a	DCP05099	
320 xd	N47 D20 C		03/13-07/15	6SBU14A	R134a	DCP05095	
320 xi	N20 B20 A; N20 B20 B		11/12-06/16	6SBU14A	R134a	DCP05095	
320 xi	N20 B20 A; N20 B20 B		05/14-06/16	6SEU14A	R134a	DCP05099	
325 d	N47 D20 D		03/13-	6SBU14A	R134a	DCP05095	
325 d	N47 D20 D	For vehicles with automatic climate control	07/13-	6SBU14A	R134a	DCP05095	
328 i	N20 B20 A; N26 B20 A		08/12-02/15	7SEU17A	R134a	DCP05097	
328 xi	N20 B20 A; N26 B20 A		03/13-07/16	6SEU14A	R134a	DCP05099	
330 d	N57 D30 A		01/14-	6SEU14A	R134a	DCP05099	
330 d	N57 D30 A	For hot climate zones	01/14-	7SEU17A	R134a	DCP05097	
330 d	N57 D30 A	not for hot climates	01/14-	6SEU14A	R134a	DCP05099	
330 xd	N57 D30 A		01/14-	6SEU14A	R134a	DCP05099	
330 xd	N57 D30 A	For hot climate zones	01/14-	7SEU17A	R134a	DCP05097	
330 xd	N57 D30 A	not for hot climates	01/14-	6SEU14A	R134a	DCP05099	
335 i	N55 B30 A		03/13-	7SBU17C	R134a	DCP05078	
335 xd	N57 D30 B		01/14-	6SEU14A	R134a	DCP05105	
335 xi	N55 B30 A		03/13-	7SBU17C	R134a	DCP05078	
<b>4 Coupe/Convertible (F32, F33) (13-)</b>							
420 d	B47 D20 A; N47 D20 C	For hot climate zones	07/13-	7SEU17A	R134a	DCP05097	
420 d	B47 D20 A;N47 D20 C		07/13-	6SEU14A	R134a	DCP05099	
420 i	N20 B20 A;N20 B20 B		11/13-02/17	6SEU14A	R134a	DCP05099	
420 i	N20 B20 A;N20 B20 B	For hot climate zones	11/13-02/17	7SBU17A	R134a	DCP05096	
420 i	N20 B20 A;N20 B20 B	For hot climate zones	11/13-02/17	7SEU17A	R134a	DCP05097	
420 xd	B47 D20 A;N47 D20 C		11/13-	6SEU14A	R134a	DCP05099	
420 xd	B47 D20 A;N47 D20 C	For hot climate zones	11/13-	7SEU17A	R134a	DCP05097	
420 xi	N20 B20 A;N20 B20 B		11/13-02/16	6SEU14A	R134a	DCP05099	
420 xi	N20 B20 A;N20 B20 B	For hot climate zones	11/13-02/16	7SEU17A	R134a	DCP05097	
425 d	N47 D20 D		03/14-02/16	6SEU14A	R134a	DCP05099	
428 i	N20 B20 A;N26 B20 A		07/13-02/17	6SEU14A	R134a	DCP05099	
428 i	N20 B20 A;N26 B20 A	For hot climate zones	07/13-02/17	7SEU17A	R134a	DCP05097	
428 xi	N20 B20 A;N26 B20 A		07/13-02/16	6SEU14A	R134a	DCP05099	
430 d	N57 D30 A		11/13-	6SEU14A	R134a	DCP05099	
430 d	N57 D30 A	For hot climate zones	11/13-	7SEU17A	R134a	DCP05097	
430 xd	N57 D30 A		03/14-	6SEU14A	R134a	DCP05099	
430 xd	N57 D30 A	For hot climate zones	03/14-	7SEU17A	R134a	DCP05097	
435 i	N55 B30 A		07/13-02/16	7SBU17C	R134a	DCP05078	
435 xd	N57 D30 B		11/13-	6SEU14A	R134a	DCP05099	
435 xi	N55 B30 A		07/13-02/16	7SBU17C	R134a	DCP05078	
<b>4 Gran Coupe (F36) (14-)</b>							
418 d	B47 D20 A;N47 D20 C		03/14-	6SEU14A	R134a	DCP05099	
420 d	B47 D20 A; N47 D20 C	For hot climate zones	03/14-	7SEU17A	R134a	DCP05097	

				TYPE	GAS	DENSO PN	OE
<b>BMW Continued</b>							
<b>4 Gran Coupe (F36) (14-) Continued</b>							
420 d	B47 D20 A; N47 D20 C			03/14-	6SEU14A	R134a	DCP05099
420 i	N20 B20 B			03/14-02/17	6SEU14A	R134a	DCP05105
420 i	N20 B20 B	For cold climates; For mild climate zones		03/14-02/17	6SEU14A	R134a	DCP05105
420 xd	B47 D20 A; N47 D20 C	For hot climate zones		03/14-	7SEU17A	R134a	DCP05097
420 xd	B47 D20 A; N47 D20 C			03/14-	6SEU14A	R134a	DCP05099
420 xi	N20 B20 A; N20 B20 B			07/14-02/16	6SEU14A	R134a	DCP05105
420 xi	N20 B20 A; N20 B20 B	For cold climates; For mild climate zones		07/14-02/16	6SEU14A	R134a	DCP05105
428 i	N20 B20 A; N26 B20 A	For cold climates; For mild climate zones		03/14-02/16	6SEU14A	R134a	DCP05105
428 xi	N20 B20 A; N26 B20 A	For cold climates; For mild climate zones		03/14-02/16	6SEU14A	R134a	DCP05105
430 d	N57 D30 A			07/14-	6SEU14A	R134a	DCP05099
430 d	N57 D30 A	For hot climate zones		07/14-	7SEU17A	R134a	DCP05097
430 xd	N57 D30 A			07/14-	6SEU14A	R134a	DCP05099
430 xd	N57 D30 A	For hot climate zones		07/14-	7SEU17A	R134a	DCP05097
435 i	N55 B30 A			03/14-02/16	7SBU17C	R134a	DCP05078
435 xd	N57 D30 B			07/14-	6SEU14A	R134a	DCP05099
435 xi	N55 B30 A			07/14-02/16	7SBU17C	R134a	DCP05078
<b>5 (E34) (87-97)</b>							
518 i	M43 B18 (184E2)			05/94-07/96	10PA17C	R134a	DCP05003
520 i 12V	M20 B20 (206KA)			06/87-09/90	10PA17C	R134a	DCP05003
520 i 24V	M50 B20 (206S1); M50 B20 (206S2)			03/90-09/96	10PA17C	R134a	DCP05003
524 td	M21 D24 (246TB)			03/88-09/91	10PA17C	R134a	DCP05012
525 i 12V	M20 B25 (256K1)			02/88-08/90	10PA17C	R134a	DCP05003
525 i 24V	M50 B25 (256S1); M50 B25 (256S2)			03/90-09/96	10PA17C	R134a	DCP05003
525 ix 24V	M50 B25 (256S1); M50 B25 (256S2)			10/91-03/96	10PA17C	R134a	DCP05003
525 td	M51 D25 (256T1)			03/93-09/96	10PA17C	R134a	DCP05004
525 tds	M51 D25 (256T1)			09/91-09/96	10PA17C	R134a	DCP05004
530 i V8	M60 B30 (308S1)			09/92-09/96	10PA17C	R134a	DCP05001
540 i	M60 B40 (408S1)			09/92-09/96	10PA17C	R134a	DCP05001
M5 3.8	S38 B38 (386S1)			01/92-07/95	10PA17C	R134a	DCP05003
<b>5 (E39) (95-04)</b>							
520 i 2.0	M52 B20 (206S3); M52 B20 (206S4)			01/96-06/03	7SBU16C	R134a	DCP05014 64526910458
520 i 2.0	M52 B20 (206S3); M52 B20 (206S4)			01/96-06/03	7SBU16C	R134a	DCP05018 64526914370
520 i 2.0	M52 B20 (206S3); M52 B20 (206S4)			01/96-06/03	7SBU16C	R134a	DCP05039 64526916232
520 i 2.0	M52 B20 (206S3); M52 B20 (206S4)			01/96-06/03	7SBU16C	R134a	DCP05040 64526915388
520 i 2.2	M54 B22 (226S1)			09/00-12/03	7SBU16C	R134a	DCP05014
523 i	M52 B25 (256S3); M52 B25 (256S4)			03/97-08/00	7SBU16C	R134a	DCP05039 64526916232
523 i	M52 B25 (256S3); M52 B25 (256S4)			03/97-08/00	7SBU16C	R134a	DCP05040 64526915388
523 i	M52 B25 (256S3); M52 B25 (256S4)			09/95-08/00	7SBU16C	R134a	DCP05018 64526914370
523 i	M52 B25 (256S3); M52 B25 (256S4)			03/97-08/00	7SBU16C	R134a	DCP05014 64526910458
525 d	M57 D25 (256D1)			02/00-05/04	7SBU16C	R134a	DCP05014
525 i	M54 B25 (256S5)			09/00-05/04	7SBU16C	R134a	DCP05014 64526910458
525 i	M54 B25 (256S5)			09/00-05/04	7SBU16C	R134a	DCP05039 64526916232
525 i	M54 B25 (256S5)			09/00-05/04	7SBU16C	R134a	DCP05040 64526915388
525 td	M51 D25 (256T1)			01/97-09/98	7SBU16C	R134a	DCP05013 64528385050
525 td	M51 D25 (256T1)			01/97-06/03	7SBU16C	R134a	DCP05017 64526914369
525 tds	M51 D25 (256T1)			01/96-09/98	7SBU16C	R134a	DCP05013 64528385050
525 tds	M51 D25 (256T1)			01/96-05/04	7SBU16C	R134a	DCP05017 64526914369
528 i	M52 B28 (286S1); M52 B28 (286S2)			09/95-08/00	7SBU16C	R134a	DCP05014 64526910458
528 i	M52 B28 (286S1); M52 B28 (286S2)			09/95-08/00	7SBU16C	R134a	DCP05018 64526914370
528 i	M52 B28 (286S1); M52 B28 (286S2)			09/95-08/00	7SBU16C	R134a	DCP05039 64526916232
528 i	M52 B28 (286S1); M52 B28 (286S2)			09/95-08/00	7SBU16C	R134a	DCP05040 64526915388
530 d	M57 D30 (306D1)			08/98-05/04	7SBU16C	R134a	DCP05014
530 i	M54 B30 (306S3)			09/00-12/03	7SBU16C	R134a	DCP05014 64526910458
530 i	M54 B30 (306S3)			09/00-12/03	7SBU16C	R134a	DCP05039 64526916232
530 i	M54 B30 (306S3)			09/00-12/03	7SBU16C	R134a	DCP05040 64526915388
535 i	M62 B35 (358S1)			06/96-09/97	7SBU16C	R134a	DCP05019 64526914371
535 i	M62 B35 (358S1); M62 B35 (358S2)			06/96-06/03	7SBU16C	R134a	DCP05039 64526916232
535 i	M62 B35 (358S1); M62 B35 (358S2)			06/96-06/03	7SBU16C	R134a	DCP05040 64526915388





				TYPE	GAS	DENSO PN	OE
<b>BMW Continued</b>							
<b>5 (E39) (95-04) Continued</b>							
535 i	M62 B35 (358S1);M62 B35 (358S2)			09/97-06/03	7SBU16C	R134a	DCP05016 64526910460
540 i	M62 B44 (448S1);M62 B44 (448S2)			03/96-09/97	7SBU16C	R134a	DCP05019 64526914371
540 i	M62 B44 (448S1);M62 B44 (448S2)			03/96-12/03	7SBU16C	R134a	DCP05039 64526916232
540 i	M62 B44 (448S1);M62 B44 (448S2)			03/96-12/03	7SBU16C	R134a	DCP05040 64526915388
540 i	M62 B44 (448S1);M62 B44 (448S2)			04/97-12/03	7SBU16C	R134a	DCP05016 64526910460
M5	S62 B50 (508S1)			10/98-06/03	7SBU16C	R134a	DCP05040 64526915388
M5	S62 B50 (508S1)			07/99-06/03	7SBU16C	R134a	DCP05016 64526910460
M5	S62 B50 (508S1)			07/99-06/03	7SBU16C	R134a	DCP05039 64526916232
<b>5 (E60, E61) (03-10)</b>							
520 d	M47 D20 (204D4);N47 D20 C			04/05-08/07	7SEU17C	R134a	DCP05042
520 d	N47 D20 A;N47 D20 C			09/07-05/10	6SEU14C	R134a	DCP05061
520 i 2.0	N43 B20 A			09/07-12/10	6SBU14C	R134a	DCP05108
520 i 2.0	N46 B20 B			04/06-12/09	6SEU14C	R134a	DCP05062
520 i 2.2	M54 B22 (226S1)			07/03-03/05	7SEU17C	R134a	DCP05020
523 i	N52 B25 A; N52 B25 B; N52 B25 BE			10/04-12/06	7SEU17C	R134a	DCP05052 64509174805
523 i	N52 B25 A;N52 B25 B;N52 B25 BE			10/04-12/06	7SEU17C	R134a	DCP05032
523 i	N52 B25 A;N52 B25 BE			01/07-03/10	7SBU17C	R134a	DCP05083 64526961621
523 i	N52 B25 A;N52 B25 BE			01/07-03/10	7SBU17C	R134a	DCP05093 64509180549
525 d 2.5	M57 D25 (256D2)			03/04-12/06	7SEU17C	R134a	DCP05020
525 d 3.0	M57 D30 (306D3)			01/07-03/10	7SEU17C	R134a	DCP05020 64509174802
525 d 3.0	M57 D30 (306D3)	S1CBA- (CO2)		03/07-05/08	7SEU17C	R134a	DCP05035
525 d 3.0	M57 D30 (306D3)	S1CBA- (CO2)		05/08-05/10	7SEU17C	R134a	DCP05092
525 d 3.0	M57 D30 (306D3)	S1CBA+ (CO2)		03/07-05/10	7SBU17C	R134a	DCP05082 64509180547
525 i 2.5	M54 B25 (256S5)			09/03-02/05	7SEU17C	R134a	DCP05020
525 i 2.5	N52 B25 A; N52 B25 B; N52 B25 BF			03/05-12/06	7SEU17C	R134a	DCP05052 64509174805
525 i 2.5	N52 B25 A;N52 B25 B;N52 B25 BF			03/05-12/06	7SEU17C	R134a	DCP05032
525 i 3.0	N53 B30 A			01/07-12/10	7SBU17C	R134a	DCP05083 64526961621
525 i 3.0	N53 B30 A			01/07-12/10	7SBU17C	R134a	DCP05093 64509180549
525 xd	M57 D30 (306D3)			11/06-09/08	7SBU17C	R134a	DCP05034
525 xd	M57 D30 (306D3)			09/07-05/10	7SEU17C	R134a	DCP05020
525 xi	N53 B30 A			09/08-03/10	7SBU17C	R134a	DCP05093 64509180549
525 xi	N53 B30 A			09/08-12/10	7SBU17C	R134a	DCP05083 64526961621
525 xi 2.5	N52 B25 A			04/05-02/07	7SEU17C	R134a	DCP05032
525 xi 3.0	N53 B30 A			01/07-09/08	7SBU17C	R134a	DCP05083 64526961621
525 xi 3.0	N53 B30 A			01/07-12/10	7SBU17C	R134a	DCP05093 64509180549
530 d	M57 D30 (306D2);M57 D30 (306D3)			09/02-03/07	7SEU17C	R134a	DCP05020
530 d	M57 D30 (306D2);M57 D30 (306D3)	S1CBA- (CO2)		09/02-05/08	7SEU17C	R134a	DCP05035
530 d	M57 D30 (306D2);M57 D30 (306D3)	S1CBA- (CO2)		09/02-05/10	7SEU17C	R134a	DCP05092
530 d	M57 D30 (306D2);M57 D30 (306D3)	S1CBA+ (CO2)		09/02-05/10	7SBU17C	R134a	DCP05082
530 i	M54 B30 (306S3)			12/01-02/05	7SEU17C	R134a	DCP05020
530 i	N52 B30 A;N52 B30 BF			09/04-03/10	7SEU17C	R134a	DCP05032
530 i	N53 B30 A			01/07-12/10	7SBU17C	R134a	DCP05083 64526961621
530 i	N53 B30 A			01/07-12/10	7SBU17C	R134a	DCP05093 64509180549
530 xd	M57 D30 (306D3)			02/05-01/07	7SEU17C	R134a	DCP05020
530 xd	M57 D30 (306D3)			03/07-08/07	7SBU17C	R134a	DCP05082 64509180547
530 xd	M57 D30 (306D3)	S1CBA- (CO2)		03/07-08/07	7SEU17C	R134a	DCP05035
530 xd	M57 D30 (306D3)	S1CBA- (CO2)		09/07-05/10	7SEU17C	R134a	DCP05092
530 xd	M57 D30 (306D3)	S1CBA+ (CO2)		09/07-05/10	7SBU17C	R134a	DCP05082
530 xi	N52 B30 A;N53 B30 A			09/04-08/08	7SEU17C	R134a	DCP05032
530 xi	N52 B30 A;N53 B30 A			03/07-05/10	7SBU17C	R134a	DCP05083 64526961621
530 xi	N52 B30 A;N53 B30 A			03/07-05/10	7SBU17C	R134a	DCP05093 64509180549
535 d	M57 D30 (306D4);M57 D30 (306D5)			09/04-12/10	7SEU17C	R134a	DCP05020
535 d	M57 D30 (306D5)			01/07-12/10	7SBU17C	R134a	DCP05082 64509180547
535 d	M57 D30 (306D5)	S1CBA- (CO2)		03/07-05/08	7SEU17C	R134a	DCP05035
535 d	M57 D30 (306D5)	S1CBA- (CO2)		05/08-12/10	7SEU17C	R134a	DCP05092
535 i	N54 B30 A			04/06-12/06	7SEU17C	R134a	DCP05052
540 i	N62 B40 A			03/06-12/09	7SEU17C	R134a	DCP05052 64509174805
540 i	N62 B40 A			01/07-12/09	7SEU17C	R134a	DCP05084 64529174806
540 i	N62 B40 A			03/07-12/09	7SEU17C	R134a	DCP05032 64509174803
545 i	N62 B44 A			09/03-09/05	7SEU17C	R134a	DCP05052
550 i	N62 B48 A;N62 B48 B			07/05-12/06	7SEU17C	R134a	DCP05052 64509174805
550 i	N62 B48 A;N62 B48 B			01/07-12/10	7SEU17C	R134a	DCP05084 64529174806
M5	S85 B50 A			09/04-03/08	7SEU17C	R134a	DCP05079 64526933174; 64509180550
<b>5 (F10, F11) (10-16)</b>							
518 d	N47 D20 C			07/13-06/14	6SBU14A	R134a	DCP05095
520 d	N47 D20 C			06/10-06/14	6SBU14A	R134a	DCP05095 64529223694; 64529225703
520 i 1.6	N20 B16 A			07/14-10/16	7SBU17A	R134a	DCP05096





				TYPE	GAS	DENSO PN	OE
<b>BMW Continued</b>							
<b>5 (F10, F11) (10-16) Continued</b>							
520 i 2.0	N20 B20 A; N20 B20 B	For vehicles with air conditioning front and rear	01/13-02/17	7SBU17A	R134a	DCP05096	
520 i 2.0	N20 B20 A;N20 B20 B		10/10-02/17	7SBU17A	R134a	DCP05096	
520 xd	N47 D20 C		07/13-06/14	6SBU14A	R134a	DCP05095	
523 i 2.5	N52 B25 A;N52 B25 AF;N52 B25 B; N52 B25 BF		11/09-08/11	7SBU17C	R134a	DCP05081	
523 i 3.0	N53 B30 A		06/09-08/11	7SBU17C	R134a	DCP05081	
525 d 2.0	N47 D20 D		09/11-02/17	6SBU14A	R134a	DCP05095	
525 d 2.0	N47 D20 D	For vehicles with air conditioning front and rear	10/12-02/17	6SBU14A	R134a	DCP05095	
525 d 3.0	N57 D30 A		03/10-08/11	7SBU17C	R134a	DCP05077	64526987890; 64529196889
525 xd	N47 D20 D		09/11-02/17	6SBU14A	R134a	DCP05095	
525 xd	N47 D20 D	For vehicles with air conditioning front and rear	08/12-02/17	6SBU14A	R134a	DCP05095	
528 i 2.0	N20 B20 A		09/11-02/17	7SBU17A	R134a	DCP05096	
528 i 3.0	N53 B30 A		11/09-08/11	7SBU17C	R134a	DCP05081	
528 xi	N20 B20 A		09/11-02/17	7SBU17A	R134a	DCP05096	
530 d	N57 D30 A		01/10-02/17	7SBU17C	R134a	DCP05077	
530 d	N57 D30 A	For vehicles with air conditioning front and rear	01/13-02/17	7SBU17A	R134a	DCP05096	
530 i	N53 B30 A		05/11-06/13	7SBU17C	R134a	DCP05081	
530 xd	N57 D30 A		03/11-02/17	7SBU17C	R134a	DCP05077	
530 xd	N57 D30 A	For vehicles with air conditioning front and rear	07/14-02/17	7SBU17A	R134a	DCP05096	
535 d	N57S		09/10-08/11	7SBU17C	R134a	DCP05077	64526987890; 64529196889
535 d	N57Z		09/11-02/17	7SBU17A	R134a	DCP05096	64529216466
535 i	N55 B30 A		01/10-06/13	7SBU17C	R134a	DCP05081	64509196890; 64529165808
535 i	N55 B30 A		08/12-02/17	7SBU17C	R134a	DCP05078	64529217868
535 xd	N57Z		09/11-02/17	7SBU17A	R134a	DCP05096	64529216466
535 xi	N55 B30 A		03/11-06/13	7SBU17C	R134a	DCP05081	64509196890; 64529165808
535 xi	N55 B30 A		08/12-02/17	7SBU17C	R134a	DCP05078	64529217868
535 xi	N55 B30 A	For vehicles with air conditioning front and rear	05/14-10/16	7SBU17C	R134a	DCP05078	
550 i	N63 B44 A;N63 B44 B		03/10-02/17	7SBU17C	R134a	DCP05076	
550 xi	N63 B44 A;N63 B44 B		08/10-10/16	7SBU17C	R134a	DCP05076	
M 550 xd	N57 D30 C		03/12-02/17	7SBU17A	R134a	DCP05096	
M5	S63 B44 B		09/11-10/16	7SBU17C	R134a	DCP05076	
M5 Competition	S63 B44 B	For vehicles with air conditioning front and rear	02/13-10/16	7SBU17C	R134a	DCP05076	
<b>5 Gran Turismo (F07) (09-17)</b>							
520 d	N47 D20 C		04/11-02/17	6SBU14A	R134a	DCP05095	64529223694
528 i	N20 B20 A		07/13-02/17	7SBU17A	R134a	DCP05096	
530 d	N57 D30 A		08/09-02/17	7SBU17C	R134a	DCP05077	
530 xd	N57 D30 A		06/10-02/17	7SBU17C	R134a	DCP05077	
535 d	N57S		03/10-06/12	7SBU17C	R134a	DCP05077	64526987890; 64529196889
535 d	N57Z		07/12-02/17	7SBU17A	R134a	DCP05096	64529216466
535 i	N55 B30 A		01/09-06/13	7SBU17C	R134a	DCP05081	64509196890; 64529165808
535 i	N55 B30 A		08/12-02/17	7SBU17C	R134a	DCP05078	64529217868
535 xd	N57S		03/10-06/12	7SBU17C	R134a	DCP05077	64526987890; 64529196889
535 xd	N57Z		07/12-02/17	7SBU17A	R134a	DCP05096	64529216466
535 xi	N55 B30 A		09/10-06/13	7SBU17C	R134a	DCP05081	64509196890; 64529165808
535 xi	N55 B30 A		08/12-02/17	7SBU17C	R134a	DCP05078	64529217868
550 i	N63 B44 A;N63 B44 B		08/09-02/17	7SBU17C	R134a	DCP05076	
550 xi	N63 B44 A;N63 B44 B		06/10-06/13	7SBU17C	R134a	DCP05076	
<b>6 (E63, E64) (04-10)</b>							
630 i	N52 B30 A;N52 B30 B;N52 B30 BF		09/04-08/07	7SEU17C	R134a	DCP05032	





				TYPE	GAS	DENSO PN	OE	
<b>BMW Continued</b>								
<b>6 (E63, E64) (04-10) Continued</b>								
630 i	N53 B30 A			09/07-08/10	7SBU17C	R134a	DCP05093	
635 d	M57 D30 (306D5)			07/07-07/10	7SBU17C	R134a	DCP05082	
645 Ci	N62 B44 A			09/03-08/05	7SEU17C	R134a	DCP05052	
650 i	N62 B48 B			09/05-08/10	7SEU17C	R134a	DCP05052	
650 i	N62 B48 B			06/06-08/10	7SEU17C	R134a	DCP05032	64509174803
M6	S85 B50 A			09/05-08/10	7SEU17C	R134a	DCP05079	
<b>6 Coupe/Convertible (F12, F13) (10-18)</b>								
640 d	N57 D30 B			09/11-06/18	7SBU17A	R134a	DCP05096	
640 i	N55 B30 A			07/11-06/18	7SBU17C	R134a	DCP05078	
640 xd	N57 D30 B			03/12-06/18	7SBU17A	R134a	DCP05096	
640 xi	N55 B30 A			03/13-06/18	7SBU17C	R134a	DCP05078	
650 i	N63 B44 A		For vehicles with air conditioning front and rear	07/11-06/12	7SBU17C	R134a	DCP05076	
650 i	N63 B44 A;N63 B44 B			12/10-06/18	7SBU17C	R134a	DCP05076	
650 xi	N63 B44 A;N63 B44 B			09/11-06/18	7SBU17C	R134a	DCP05076	
M6	S63 B44 B			03/12-06/18	7SBU17C	R134a	DCP05076	
M6 Competition	S63 B44 B		For vehicles with air conditioning front and rear	07/13-06/18	7SBU17C	R134a	DCP05076	
<b>6 Gran Coupe (F06) (11-18)</b>								
640 d	N57 D30 B			03/12-10/18	7SBU17A	R134a	DCP05096	
640 i	N55 B30 A		For vehicles with air conditioning front and rear	03/12-10/18	7SBU17C	R134a	DCP05078	
640 xd	N57 D30 B		For vehicles with air conditioning front and rear	03/13-10/18	7SBU17A	R134a	DCP05096	
640 xi	N55 B30 A		For vehicles with air conditioning front and rear	03/13-10/18	7SBU17C	R134a	DCP05078	
650 i	N63 B44 B		For vehicles with air conditioning front and rear	07/12-10/18	7SBU17C	R134a	DCP05076	
650 xi	N63 B44 B		For vehicles with air conditioning front and rear	07/12-10/18	7SBU17C	R134a	DCP05076	
M6	S63 B44 B		For vehicles with air conditioning front and rear	03/13-10/18	7SBU17C	R134a	DCP05076	
M6 Competition	S63 B44 B		For vehicles with air conditioning front and rear	07/13-10/18	7SBU17C	R134a	DCP05076	
<b>7 (E32) (86-94)</b>								
730 i V8	M60 B30 (308S1)			04/92-05/94	10PA17C	R134a	DCP05001	
740 i	M60 B40 (408S1)			09/92-05/94	10PA17C	R134a	DCP05001	
750 i	M70 B50 (5012A)			09/87-05/94	10PA17C	R134a	DCP05006	
<b>7 (E38) (94-01)</b>								
725 tds	M51 D25 (256T1)			04/96-12/98	7SBU16C	R134a	DCP05013	
728 i	M52 B28 (286S1); M52 B28 (286S2)			08/95-11/01	7SBU16C	R134a	DCP05014	64526910458
728 i	M52 B28 (286S1); M52 B28 (286S2)			08/95-11/01	7SBU16C	R134a	DCP05018	64526914370
728 i	M52 B28 (286S1); M52 B28 (286S2)			08/95-11/01	7SBU16C	R134a	DCP05039	64526916232
728 i	M52 B28 (286S1); M52 B28 (286S2)			08/95-11/01	7SBU16C	R134a	DCP05040	64526915388
730 d	M57 D30 (306D1)			08/98-04/00	7SBU16C	R134a	DCP05014	
730 d	M57 D30 (306D1)			04/00-11/01	10PA17C	R134a	DCP05008	
730 i	M60 B30 (308S1)			03/94-11/01	10PA17C	R134a	DCP05008	
735 i	M62 B35 (358S1)			03/96-09/97	10PA17C	R134a	DCP05008	64528391880
735 i	M62 B35 (358S1)			03/96-08/98	7SBU16C	R134a	DCP05040	64526915388
735 i	M62 B35 (358S1)			09/97-08/98	7SBU16C	R134a	DCP05039	64526916232
740 d	M67 D39 (398D1)			05/99-11/01	10PA17C	R134a	DCP05008	
740 i 4.0	M60 B40 (408S1)			03/94-03/96	10PA17C	R134a	DCP05008	
740 i 4.4	M62 B44 (448S1); M62 B44 (448S2)			02/96-09/97	10PA17C	R134a	DCP05008	64528391880
740 i 4.4	M62 B44 (448S1); M62 B44 (448S2)			02/96-07/01	7SBU16C	R134a	DCP05040	64526915388
740 i 4.4	M62 B44 (448S1); M62 B44 (448S2)			09/97-04/00	7SBU16C	R134a	DCP05016	64526910460
740 i 4.4	M62 B44 (448S1); M62 B44 (448S2)			09/97-07/01	7SBU16C	R134a	DCP05039	64526916232
750 i	M73 B54 (54121); M73 B54 (54122)			11/94-09/97	10PA17C	R134a	DCP05009	
<b>7 (E65, E66) (01-08)</b>								
730 d	M57 D30 (306D2);M57 D30 (306D3)			06/02-09/03	7SEU17C	R134a	DCP05094	





				TYPE	GAS	DENSO PN	OE
<b>BMW Continued</b>							
<b>7 (E65, E66) (01-08) Continued</b>							
730 d	M57 D30 (306D2);M57 D30 (306D3)			09/03-08/08	7SEU17C	R134a	DCP05020
730 i	M54 B30 (306S3)			09/03-02/05	7SEU17C	R134a	DCP05020
730 i	N52 B30 A			03/05-07/08	7SEU17C	R134a	DCP05032 64509174803
730 i	N52 B30 A			03/05-07/08	7SEU17C	R134a	DCP05052 64509174805
735 i	N62 B36 A			11/01-02/05	7SEU17C	R134a	DCP05021
740 d	M67 D39 (398D1)			10/02-02/05	7SEU17C	R134a	DCP05107
740 i	N62 B40 A			03/05-08/08	7SEU17C	R134a	DCP05032 64509174803
740 i	N62 B40 A			03/05-08/08	7SEU17C	R134a	DCP05052 64509174805
745 d	M67 D44 (448D1)			03/05-07/08	7SEU17C	R134a	DCP05042
745 i	N62 B44 A			07/01-03/05	7SEU17C	R134a	DCP05038
750 i	N62 B48 B			03/05-08/08	7SEU17C	R134a	DCP05021 64526901781
750 i	N62 B48 B			03/05-08/08	7SEU17C	R134a	DCP05032 64509174803
750 i	N62 B48 B			03/05-08/08	7SEU17C	R134a	DCP05052 64509174805
760 i	N73 B60 A; N73 B60 B			01/03-08/08	7SEU17C	R134a	DCP05038
<b>7 (F01, F02, F03, F04) (08-15)</b>							
730 d	N57 D30 A			02/08-05/15	7SBU17C	R134a	DCP05077
730 i	N52 B30 A; N52 B30 BF			06/09-06/15	7SBU17C	R134a	DCP05081
730 xd	N57 D30 A			11/11-05/15	7SBU17C	R134a	DCP05077
730 xd	N57 D30 A	For vehicles with air conditioning front and rear		11/11-05/15	7SBU17A	R134a	DCP05096
740 d	N57 D30 B			09/09-06/15	7SBU17C	R134a	DCP05077
740 i	N55 B30 A	For vehicles with air conditioning front and rear		07/12-12/15	7SBU17C	R134a	DCP05078
740 xd	N57 D30 B			09/10-06/15	7SBU17C	R134a	DCP05077
740 xi	N55 B30 A	For vehicles with air conditioning front and rear		07/12-12/15	7SBU17C	R134a	DCP05078
750 i, Li	N63 B44 A			09/08-06/12	7SBU17C	R134a	DCP05076
750 i, Li	N63 B44 B	For vehicles with air conditioning front and rear		07/12-06/15	7SBU17C	R134a	DCP05076
750 xd	N57 D30 C			07/12-12/15	7SBU17A	R134a	DCP05096
750 xi	N63 B44 A; N63 B44 B			09/09-06/12	7SBU17C	R134a	DCP05076
750 xi	N63 B44 B	For vehicles with air conditioning front and rear		07/12-06/15	7SBU17C	R134a	DCP05076
760 i	N74 B60 A			09/09-12/15	7SBU17C	R134a	DCP05076
<b>8 (E31) (90-99)</b>							
840 Ci	M62 B44 (448S1)			03/96-06/99	10PA17C	R134a	DCP05001
840 i	M60 B40 (408S1)			03/93-02/96	10PA17C	R134a	DCP05001
<b>X1 (E84) (09-15)</b>							
16 d	N47 D20 C			04/12-06/15	6SBU14C	R134a	DCP05050
16 i	N20 B16 A			03/13-06/15	6SBU14A	R134a	DCP05095
18 d	N47 D20 C	S1CBA- (CO2)		03/09-06/15	6SEU14C	R134a	DCP05061 64526987863
18 d	N47 D20 C	S1CBA+ (CO2)		03/09-06/15	6SBU14C	R134a	DCP05050 64526987862
18 i	N46 B20 B; N46 B20 BD			03/10-06/15	6SBU14A	R134a	DCP05095
18 i	N46 B20 B; N46 B20 BD; N46 B20 C; N46 B20 CC; N46 B20 CD; N46 B20 E	S1CBA- (CO2)		03/10-06/15	6SEU14C	R134a	DCP05061 64526987863
18 i	N46 B20 B; N46 B20 BD; N46 B20 C; N46 B20 CC; N46 B20 CD; N46 B20 E	S1CBA+ (CO2)		03/10-06/15	6SBU14C	R134a	DCP05050 64526987862
18 xd	N47 D20 C	S1CBA- (CO2)		03/09-06/15	6SEU14C	R134a	DCP05061 64526987863
18 xd	N47 D20 C	S1CBA+ (CO2)		03/09-06/15	6SBU14C	R134a	DCP05050 64526987862
20 d	N47 D20 C			07/12-06/15	6SBU14A	R134a	DCP05095
20 d	N47 D20 C	S1CBA- (CO2)		10/09-06/15	6SEU14C	R134a	DCP05061 64526987863
20 d	N47 D20 C	S1CBA+ (CO2)		10/09-06/15	6SBU14C	R134a	DCP05050 64526987862
20 i	N20 B20 A			09/11-06/15	6SBU14A	R134a	DCP05095
20 xd	N47 D20 C	S1CBA- (CO2)		09/09-06/15	6SEU14C	R134a	DCP05061 64526987863
20 xd	N47 D20 C	S1CBA+ (CO2)		09/09-06/15	6SBU14C	R134a	DCP05050 64526987862
20 xi	N20 B20 A			09/11-06/15	6SBU14A	R134a	DCP05095
23 xd	N47 D20 D	S1CBA- (CO2)		10/09-06/15	6SEU14C	R134a	DCP05061 64526987863
23 xd	N47 D20 D	S1CBA+ (CO2)		10/09-06/15	6SBU14C	R134a	DCP05050 64526987862
25 xd	N47 D20 D			10/09-06/15	6SEU14C	R134a	DCP05061
25 xi	N52 B30 A			03/10-08/11	7SEU17C	R134a	DCP05036
28 xi 2.0	N20 B20 A			03/11-06/15	6SBU14A	R134a	DCP05095
28 xi 3.0	N52 B30 A			09/09-08/11	7SEU17C	R134a	DCP05036
<b>X3 (E83) (04-11)</b>							
2.0 i	N46 B20 B			07/05-07/06	7SBU16C	R134a	DCP05039











				TYPE	GAS	DENSO PN	OE
<b>BMW Continued</b>							
<b>X3 (E83) (04-11) Continued</b>							
2.0 i	N46 B20 B		07/05-08/08	7SBU16C	R134a	DCP05040	64526915388
2.5 i	M54 B25 (256S5)		03/04-07/06	7SBU16C	R134a	DCP05039	
2.5 i	M54 B25 (256S5)		03/04-07/06	7SBU16C	R134a	DCP05040	64526915388
2.5 si	N52 B25 A		08/06-08/08	7SBU16C	R134a	DCP05031	
2.5 sxi	N52 B25 A; N52 B25 AF; N52 B25 BF		08/06-08/08	7SBU16C	R134a	DCP05031	
3.0 d	M57 D30 (306D2);M57 D30 (306D3)		01/04-08/08	7SBU16C	R134a	DCP05039	
3.0 d	M57 D30 (306D2);M57 D30 (306D3)		01/04-08/08	7SBU16C	R134a	DCP05040	64526915388
3.0 sd	M57 D30 (306D5)		09/06-08/08	7SBU16C	R134a	DCP05039	
3.0 sd	M57 D30 (306D5)		09/06-08/08	7SBU16C	R134a	DCP05040	64526915388
3.0 si	N52 B30 A		08/06-08/08	7SBU16C	R134a	DCP05031	
3.0 xi	M54 B30 (306S3)		09/03-07/06	7SBU16C	R134a	DCP05039	
3.0 xi	M54 B30 (306S3)		09/03-07/06	7SBU16C	R134a	DCP05040	64526915388
25 xi	N52 B25 A		09/08-08/10	7SBU16C	R134a	DCP05031	
30 xd	M57 D30 (306D3)		09/08-08/10	7SBU16C	R134a	DCP05039	
30 xd	M57 D30 (306D3)		09/08-08/10	7SBU16C	R134a	DCP05040	64526915388
30 xi	N52 B30 A		09/08-09/10	7SBU16C	R134a	DCP05031	
35 xd	M57 D30 (306D5)		09/08-08/11	7SBU16C	R134a	DCP05039	
35 xd	M57 D30 (306D5)		09/08-08/11	7SBU16C	R134a	DCP05040	64526915388
<b>X3 (F25) (10-17)</b>							
18 d	B47 D20 A;N47 D20 C		10/12-08/17	7SEU17A	R134a	DCP05097	
20 i 1.6	N20 B16 A		04/14-08/17	7SEU17A	R134a	DCP05097	
20 i 2.0	N20 B20 A		04/14-08/17	7SEU17A	R134a	DCP05097	
20 xd	B47 D20 A;N47 D20 C		12/12-12/16	7SEU17A	R134a	DCP05097	
20 xd	N47 D20 C		09/10-12/12	6SEU14A	R134a	DCP05091	
20 xi	N20 B20 A		10/11-08/17	7SEU17A	R134a	DCP05097	
28 xi 2.0	N20 B20 A		04/12-08/17	7SEU17A	R134a	DCP05097	
28 xi 3.0	N52 B30 A; N52 B30 AF; N52 B30 BF		01/11-10/12	7SEU17C	R134a	DCP05089	64529211496
28 xi 3.0	N52 B30 A; N52 B30 AF; N52 B30 BF		01/11-10/12	7SEU17A	R134a	DCP05097	64529216467
30 xd	N57 D30 A		04/11-08/17	7SEU17A	R134a	DCP05097	
35 xd	N57 D30 B		10/11-08/17	7SEU17A	R134a	DCP05097	
35 xi	N55 B30 A		09/10-08/17	7SEU17C	R134a	DCP05090	
<b>X4 (F26) (14-18)</b>							
20 xi	N20 B20 A		04/14-03/18	7SEU17A	R134a	DCP05097	
28 xi	N20 B20 A		04/14-03/18	7SEU17A	R134a	DCP05097	
30 xd	N57 D30 A		04/14-03/18	7SEU17A	R134a	DCP05097	
30 xd	N57 D30 A	For vehicles with automatic climate control	04/14-03/18	7SEU17A	R134a	DCP05097	
35 xd	N57 D30 B		04/14-03/18	7SEU17A	R134a	DCP05097	
35 xi	N55 B30 A		04/14-03/18	7SEU17C	R134a	DCP05090	
<b>X5 (E53) (00-06)</b>							
4.4 i	M62 B44 (448S2);N62 B44 A;N62 B44		01/00-10/06	10S17C	R134a	DCP05046	
4.6 is	M62 B46 (468S1)		10/01-09/03	10S17C	R134a	DCP05046	
4.8 is	N62 B48 A		04/04-09/06	10S17C	R134a	DCP05046	
<b>X5 (E70) (07-13)</b>							
30 xd	M57 D30 (306D3);N57 D30 A		10/08-07/13	7SBU17C	R134a	DCP05077	
35 xi	N55 B30 A		04/10-07/13	7SBU17C	R134a	DCP05078	
40 xd	N57 D30 B		09/10-06/13	7SBU17C	R134a	DCP05077	
50 xi	N63 B44 A		04/10-07/13	7SEU17C	R134a	DCP05080	
M	S63 B44 A		07/09-07/13	7SBU17A	R134a	DCP05096	
M 50 d	N57 D30 C		08/11-06/13	7SBU17A	R134a	DCP05096	
<b>X5 (F15) (12-18)</b>							
25 d	B47 D20 B;N47 D20 D	For vehicles with air conditioning front and rear	12/13-07/18	7SBU17A	R134a	DCP05096	
25 d	N47 D20 D		12/13-07/15	7SBU17A	R134a	DCP05096	
25 xd 2.0	B47 D20 B;N47 D20 D	For vehicles with air conditioning front and rear	12/13-07/18	7SBU17A	R134a	DCP05096	
25 xd 2.0	N47 D20 D		12/13-07/15	7SBU17A	R134a	DCP05096	
25 xd 3.0	N57 D30 A	For vehicles with air conditioning front and rear	04/14-07/18	7SBU17A	R134a	DCP05096	
30 xd	N57 D30 A		08/13-07/18	7SBU17A	R134a	DCP05096	
30 xd	N57 D30 A	For vehicles with air conditioning front and rear	08/13-07/18	7SBU17A	R134a	DCP05096	
35 xi	N55 B30 A		12/13-07/18	7SBU17C	R134a	DCP05078	





				TYPE	GAS	DENSO PN	OE
<b>BMW Continued</b>							
<b>X5 (F15) (12-18) Continued</b>							
35 xi	N55 B30 A	For vehicles with 2 zone automatic air conditioning	12/13-07/18	7SBU17C	R134a	DCP05078	
40 xd	N57 D30 B		12/13-07/18	7SBU17A	R134a	DCP05096	
50 xi	N63 B44 B		08/13-07/18	7SBU17C	R134a	DCP05076	
M	S63 B44 B	For vehicles with air conditioning front and rear	12/14-07/18	7SBU17C	R134a	DCP05076	
M 50 d	N57 D30 C		12/13-07/18	7SBU17A	R134a	DCP05096	
<b>X6 (E71, E72) (08-14)</b>							
30 xd	M57 D30 (306D3);N57 D30 A		04/08-07/14	7SBU17C	R134a	DCP05077	
35 xi	N 55 B30 A;N55 B30 A		01/08-07/14	7SBU17C	R134a	DCP05078	
40 xd	N57 D30 B		07/09-06/14	7SBU17C	R134a	DCP05077	
50 xi	N63 B44 A		07/08-07/14	7SEU17C	R134a	DCP05080	
M	S63 B44 A		03/10-07/14	7SEU17C	R134a	DCP05080	
M 50 d	N57 D30 C		08/11-06/14	7SBU17A	R134a	DCP05096	
<b>X6 (F16) (14-19)</b>							
30 xd	N57 D30 A	For vehicles with air conditioning front and rear	08/14-07/19	7SBU17A	R134a	DCP05096	
35 xi	N55 B30 A	For vehicles with air conditioning front and rear	08/14-07/19	7SBU17C	R134a	DCP05078	
40 xd	N57 D30 B	For vehicles with air conditioning front and rear	12/14-07/19	7SBU17A	R134a	DCP05096	
50 xi	N63 B44 B	For vehicles with 2 zone automatic air conditioning	08/14-07/19	7SEU17C	R134a	DCP05020	
M	S63 B44 B	For vehicles with air conditioning front and rear	12/14-07/19	7SBU17C	R134a	DCP05076	
M 50 d	N57 D30 C	For vehicles with air conditioning front and rear	08/14-07/19	7SBU17A	R134a	DCP05096	
<b>Z3 (E36) (95-03)</b>							
1.8 i	M43 B18 (184E2)		10/95-10/98	10PA17C	R134a	DCP05003	
1.9 i	M43 B19 (194E1);M44 B19 (194S1)		11/95-01/03	10PA17C	R134a	DCP05003	
2.0 i	M52 B20 (206S4)		04/99-07/00	10PA17C	R134a	DCP05003	
2.2 i	M54 B22 (226S1)		10/00-06/02	10PA17C	R134a	DCP05003	
2.8 i	M52 B28 (286S1)		11/96-06/00	10PA17C	R134a	DCP05003	
3.0 i	M54 B30 (306S3)		06/00-07/02	10PA17C	R134a	DCP05003	
3.2 M	S50 B32 (326S1)		07/98-06/00	10PA17C	R134a	DCP05003	
<b>Z4 (E89) (09-16)</b>							
18 i	N20 B20 A		04/13-08/16	6SBU14A	R134a	DCP05095	
20 i	N20 B20 A		09/11-08/16	6SBU14A	R134a	DCP05095	
23 i	N52 B25 A		03/09-09/11	7SEU17C	R134a	DCP05032	
28 i	N20 B20 A		09/11-08/16	6SBU14A	R134a	DCP05095	
30 i	N52 B30 A		02/09-08/11	7SEU17C	R134a	DCP05032	
30 i	N52 B30 A		02/09-08/11	7SBU17C	R134a	DCP05088	64529122619
35 i	N54 B30 A		02/09-08/16	7SEU17C	R134a	DCP05033	
35 is	N54 B30 A		03/10-08/16	7SEU17C	R134a	DCP05033	
<b>Z3 (E52) (00-03)</b>							
4.9	S62 B50 (508S1)		06/00-06/03	7SBU16C	R134a	DCP05016	64526910460
4.9	S62 B50 (508S1)		06/00-06/03	7SBU16C	R134a	DCP05039	64526916232
4.9	S62 B50 (508S1)		06/00-06/03	7SBU16C	R134a	DCP05040	64526915388
<b>CHRYSLER</b>							
<b>300 C (04-12)</b>							
3.0 CRD	EXL		09/05-11/12	10S17C	R134a	DCP06020	
3.0 V6 CRD	EXL		11/10-11/12	10S17C	R134a	DCP06020	
3.5	EEG;EGG		01/06-12/06	10S17C	R134a	DCP06027	
3.5 AWD	EGG		01/06-12/06	10S17C	R134a	DCP06027	
5.7	EZB;EZD;EZH		09/04-09/07	10S17C	R134a	DCP06027	
5.7 AWD	EZB; EZH		04/05-09/07	10S17C	R134a	DCP06027	
6.1 SRT8	ESF		06/05-09/07	10S17C	R134a	DCP06027	
<b>Grand VOYAGER V (07-)</b>							
3.3	EGV		01/08-02/08	10S20H	R134a	DCP06017	05005441AJA
<b>NEON I (94-00)</b>							
2.0 16V	ECB;ECC		04/96-08/99	10PA17C	R134a	DCP06009	5264732





				TYPE	GAS	DENSO PN	OE
<b>CHRYSLER</b> <i>Continued</i>							
<b>NEON II (99-06)</b>							
2.0 16V	420H; ECB		08/99-12/06	10PA17C	R134a	DCP06009	
<b>PT CRUISER (00-10)</b>							
2.0	ECC		06/00-12/10	10S17C	R134a	DCP06012	
2.2 CRD	EDJ		03/02-12/10	10S17C	R134a	DCP06012	5080494A*
2.4	EDV;EDZ		06/00-12/10	10S17C	R134a	DCP06012	
2.4 GT	EDV		08/03-12/10	10S17C	R134a	DCP06012	
<b>VOYAGER III (95-01)</b>							
2.0 i	C00		01/98-03/01	10PA17C	R134a	DCP06003	4677205AB
2.4 i	EDZ		01/97-03/01	10PA17C	R134a	DCP06003	4677205
2.5 TD	425 CLIRS/X; ENC		01/98-03/01	10PA17C	R134a	DCP99004	
2.5 TDiC AWD	ENC		10/95-03/01	10PA17C	R134a	DCP99004	
3.3 i	EGA		10/95-09/00	10PA17J	R134a	DCP06006	4677144ABE
3.3 i	R00	All Climate zones	01/95-03/01	10PA17J	R134a	DCP06005	
3.8 i AWD	EGH		10/95-03/01	10PA17J	R134a	DCP06006	4677144ABE
3.8 i AWD	EGH;L00	All Climate zones	01/95-03/01	10PA17J	R134a	DCP06005	
<b>VOYAGER IV (00-08)</b>							
2.5 CRD	ENJ		03/01-04/04	10S20C	R134a	DCP06016	05005420AEA
2.5 CRD	ENJ		07/04-02/08	10S17C	R134a	DCP06018	05005421AA
2.8 CRD	ENR		06/04-02/08	10S17C	R134a	DCP06018	05005421AA
3.3	EGA; EGM		02/00-04/04	10S20H	R134a	DCP06017	5005440AA
3.8	EGH		10/00-09/02	10PA17J	R134a	DCP06006	4677144ABE
3.8	EGH	All Climate zones	02/00-12/08	10PA17J	R134a	DCP06005	
3.8 AWD	EGH		10/00-09/02	10PA17J	R134a	DCP06006	4677144ABE
3.8 AWD	EGH	All Climate zones	02/00-12/08	10PA17J	R134a	DCP06005	
<b>CITROËN</b>							
<b>BERLINGO (B9) (08-)</b>							
1.2 PureTech 110			02/16-	5SEL12	R134a; R1234yf	DCP21021	
1.6	NFR (TU5JP4B);NFU (TU5JP4)		04/08-	5SEL12	R134a; R1234yf	DCP21021	
1.6 BlueHDi 100	BHY (DV6FD)		12/14-	5SEL12	R134a; R1234yf	DCP21021	
1.6 BlueHDi 100	BHY (DV6FD);DV6F*/EB2DT*		12/14-	5SEL12	R134a; R1234yf	DCP21022	
1.6 BlueHDi 100 4x4	BHY (DV6FD)		12/14-	5SEL12	R134a; R1234yf	DCP21021	
1.6 BlueHDi 120	BHZ (DV6FC)		12/14-	5SEL12	R134a; R1234yf	DCP21021	
1.6 BlueHDi 120	BHZ (DV6FC);DV6F*/EB2DT*		12/14-	5SEL12	R134a; R1234yf	DCP21022	
1.6 HDi 110	9HL (DV6C);9HR (DV6C);9HZ (DV6TED4)		04/08-	5SEL12	R134a; R1234yf	DCP21021	
1.6 HDi 115	9HL (DV6C);9HR (DV6C)		07/10-	5SEL12	R134a; R1234yf	DCP21021	
1.6 HDi 115 4x4	9HR (DV6C)		02/12-	5SEL12	R134a; R1234yf	DCP21021	
1.6 HDi 75 16V	9HT (DV6BTED4);9HT (DV6BUTED4)		04/08-	5SEL12	R134a; R1234yf	DCP21021	
1.6 HDi 75 8V / BlueHDi 75	9HN (DV6ETED);BHW (DV6FE)		04/08-	5SEL12	R134a; R1234yf	DCP21021	
1.6 HDi 75 8V / BlueHDi 75	9HN (DV6ETED);BHW (DV6FE)		04/08-	5SEL12	R134a; R1234yf	DCP21022	
1.6 HDi 75 8V 4x4	9HN (DV6ETED)		02/12-	5SEL12	R134a; R1234yf	DCP21021	
1.6 HDi 90	9HE (DV6DBM);9HF (DV6DTED); 9HJ (DV6DTEDM);9HP (DV6DTED); 9HX (DV6ATED4)		04/08-	5SEL12	R134a; R1234yf	DCP21021	
1.6 HDi 90 16V	9HS (DV6TED4BU);9HX (DV6ATED4); 9HX (DV6AUTED4)		04/08-	5SEL12	R134a; R1234yf	DCP21021	9676862380
1.6 HDi 90 4x4	9HF (DV6DTED)		02/12-	5SEL12	R134a; R1234yf	DCP21021	
1.6 HDi 92	9HJ (DV6DTEDM)		07/10-	5SEL12	R134a; R1234yf	DCP21021	
1.6 VTi 120	5FS (EP6C)		11/09-	5SEL12	R134a; R1234yf	DCP21021	
1.6 VTi 95	5FK (EP6CB)		07/10-	5SEL12	R134a; R1234yf	DCP21021	9676862380
<b>C3 Aircross (17-)</b>							
1.2 PureTech 110	HNP (EB2ADT); HNV (EB2DTM); HNZ (EB2DT)		06/17-	5SEL12C	R134a; R1234yf	DCP21024	
1.2 PureTech 130	HNS (EB2ADTS); HNY (EB2DTS)		07/17-	5SEL12C	R134a; R1234yf	DCP21024	

				TYPE	GAS	DENSO PN	OE
<b>CITROËN</b> <i>Continued</i>							
<b>C3 Aircross (17-)</b> <i>Continued</i>							
1.2 PureTech 82	HMR (EB2FA); HMZ (EB2F)		06/17-	5SEL12C	R134a; R1234yf	DCP21024	
1.6 BlueHDi 100	BHY (DV6FD)		07/17-	5SEL12C	R134a; R1234yf	DCP21024	
1.6 BlueHDi 115	BHX (DV6FC)		06/17-	5SEL12C	R134a; R1234yf	DCP21024	
1.6 BlueHDi 120	BHZ (DV6FC)		07/17-	5SEL12C	R134a; R1234yf	DCP21024	
<b>C3 II (09-)</b>							
1.0 VTi 68	ZMZ (EB0)		01/13-	5SEL09C	R134a	DCP21015	
1.2 THP 110	HNZ (EB2DT)		10/14-	5SEL09C	R134a	DCP21015	
1.2 THP 110	HNZ (EB2DT)		10/14-	5SEL12C	R1234yf	DCP21016	9675659880
1.2 VTi 82	HMZ (EB2); HMZ (EB2F)		01/13-09/16	5SEL09C	R134a	DCP21015	
<b>C3 Picasso (09-)</b>							
1.2 THP 110	HNZ (EB2DT)		01/15-	5SEL12C	R1234yf	DCP21016	9675659880
<b>C4 (Grand) Picasso I (06-13)</b>							
1.6 16V	5FT (EP6DT);5FX (EP6DT)		07/08-08/13	6SEL16C	R134a	DCP07010	6487 42
1.6 16V	5FT (EP6DT);5FX (EP6DT)		07/08-08/13	6SEL16C	R134a	DCP21014	6487 40
1.6 HDi	9HY (DV6TED4);9HZ (DV6TED4)		02/07-08/13	6SEL16C	R134a	DCP07010	6453 YQ
1.6 THP 140	5FT (EP6DT)		07/08-08/13	6SEL16C	R134a	DCP07010	6487 42
1.6 THP 140	5FT (EP6DT)		07/08-08/13	6SEL16C	R134a	DCP21014	6487 40
1.6 THP 155	5FV (EP6CDT)		09/10-08/13	6SEL16C	R134a	DCP07010	6487 42
1.6 THP 155	5FV (EP6CDT)		09/10-08/13	6SEL16C	R134a	DCP21014	6487 40
1.6 VTi 120	5FW (EP6)		07/08-08/13	6SEL16C	R134a	DCP07010	6487 42
1.6 VTi 120	5FW (EP6)		07/08-08/13	6SEL16C	R134a	DCP21014	6487 40
1.8 i 16V	6FY (EW7A)		02/07-12/11	6SEL16C	R134a	DCP07010	6453 YQ
2.0 HDi 138	RHJ (DW10BTED4);RHR (DW10BTED4)		10/06-12/13	6SEL16C	R134a	DCP07010	6453 YQ
2.0 i 16V	RFJ (EW10A)		04/07-08/13	6SEL16C	R134a	DCP07010	6453 YQ
<b>C4 (Grand) Picasso II (13-)</b>							
1.2 THP 130	HNY (EB2DTS)		04/14-	5SEL12C	R1234yf	DCP21016	9675659880
1.6 BlueHDi 100	BHY (DV6FD)		12/14-	5SEL12C	R1234yf	DCP21016	9675659880
1.6 BlueHDi 120	BHZ (DV6FC)		07/14-	5SEL12C	R1234yf	DCP21016	9675659880
1.6 HDi / BlueHDi 115	9HC (DV6C); BHX (DV6FC)		02/13-	5SEL12C	R1234yf	DCP21017	9675659880
1.6 HDi / BlueHDi 115	9HC (DV6C);BHX (DV6FC)		02/13-	5SEL12C	R1234yf	DCP21016	9675659880
1.6 HDi 90	9HP (DV6DTED)		02/13-	5SEL12C	R1234yf	DCP21016	9675659880
1.6 HDi 90	9HP (DV6DTED)		02/13-	5SEL12C	R1234yf	DCP21017	9675659880
1.6 THP 150	5FX (EP6DT)		09/14-	5SEL12C	R1234yf	DCP21016	9675659880
1.6 THP 155	5FV (EP6CDT)		02/13-	5SEL12C	R1234yf	DCP21017	9675659880
1.6 THP 165	5GZ (EP6FDT)		07/14-	5SEL12C	R1234yf	DCP21016	9675659880
1.6 VTi 120	5FS (EP6C)		02/13-	5SEL12C	R1234yf	DCP21017	9675659880
2.0 BlueHDi 135	AHV (DW10FD);RHD (DW10CB)		09/13-	5SEL12C	R1234yf	DCP21016	
2.0 BlueHDi 150	AHE (DW10FD);AHR (DW10FD);AHX (DW10FD)		06/13-	5SEL12C	R1234yf	DCP21016	9675659880
<b>C4 Cactus (14-)</b>							
1.2 THP 110	HNP (EB2ADT); HNV (EB2DTM); HNZ (EB2DT)		09/14-	5SEL12C	R1234yf	DCP21016	
1.2 VTi 75 / PureTech 75	HMU (EB2D); HMU (EB2FD)		09/14-	5SEL12C	R1234yf	DCP21016	
1.2 VTi 82	HMZ (EB2F)		09/14-	5SEL12C	R1234yf	DCP21016	
<b>C4 Coupe (04-11)</b>							
1.6 THP 150	5FX (EP6DT)		07/08-06/10	6SEL16C	R134a	DCP21014	6487 40
1.6 THP 150	5FX (EP6DT)		07/08-06/10	5SEL12	R134a; R1234yf	DCP21021	9676862380
1.6 VTi 120	5FW (EP6)		07/08-06/10	6SEL16C	R134a	DCP21014	6487 40
1.6 VTi 120	5FW (EP6)		07/08-06/10	5SEL12	R134a; R1234yf	DCP21021	9676862380
<b>C4 I (LC, LR) (04-11)</b>							
1.6 THP 140	5FT (EP6DT)		07/08-06/10	6SEL16C	R134a	DCP21014	6487 40
1.6 THP 140	5FT (EP6DT)		07/08-06/10	5SEL12	R134a; R1234yf	DCP21021	9676862380
1.6 THP 150	5FX (EP6DT)		07/08-06/10	6SEL16C	R134a	DCP21014	6487 40
1.6 THP 150	5FX (EP6DT)		07/08-06/10	5SEL12	R134a; R1234yf	DCP21021	9676862380
1.6 VTi 120	5FW (EP6)		07/08-06/10	6SEL16C	R134a	DCP21014	6487 40
1.6 VTi 120	5FW (EP6)		07/08-06/10	5SEL12	R134a; R1234yf	DCP21021	9676862380
<b>C4 II (B7, NC) (09-)</b>							
1.2 THP 110	EB*/DV6F*;HNZ (EB2DT)		02/15-	5SEL12	R134a; R1234yf	DCP21022	
1.2 THP 130	HNY (EB2DTS)		04/14-	5SEL12	R134a; R1234yf	DCP21022	
1.4 VTi 95	8FP (EP3C)		11/09-09/16	5SEL12	R134a; R1234yf	DCP21022	





				TYPE	GAS	DENSO PN	OE
<b>CITROËN</b> <i>Continued</i>							
<b>C4 II (B7, NC) (09-)</b> <i>Continued</i>							
1.4 VTi 95	8FP (EP3C)		01/11-	5SEL12	R134a; R1234yf	DCP21021	9676862380
1.6 BlueHDi 100	BHY (DV6FD);EB*/DV6F*		07/14-	5SEL12	R134a; R1234yf	DCP21022	
1.6 BlueHDi 115	BHX (DV6FC);EB*/DV6F*		08/14-	5SEL12	R134a; R1234yf	DCP21022	
1.6 BlueHDi 120	BHZ (DV6FC);EB*/DV6F*		02/15-	5SEL12	R134a; R1234yf	DCP21022	
1.6 HDi 110	9HR (DV6C)		09/10-	5SEL12	R134a; R1234yf	DCP21021	
1.6 HDi 110	EB*/DV6F*		10/16-	5SEL12	R134a; R1234yf	DCP21022	
1.6 HDi 115	9HD (DV6C)	For cold climates; For mild climate zones	07/12-	5SEL12	R134a; R1234yf	DCP21021	
1.6 HDi 115	EB*/DV6F*		10/16-	5SEL12	R134a; R1234yf	DCP21022	
1.6 HDi 90	9HJ (DV6DTEDM); 9HP (DV6DTE)		09/10-	5SEL12	R134a; R1234yf	DCP21021	
1.6 HDi 90	EB*/DV6F*		10/16-	5SEL12	R134a; R1234yf	DCP21022	
1.6 THP 155	5FV (EP6CDT)		09/10-12/16	5SEL12	R134a; R1234yf	DCP21021	
1.6 THP 155	5FV (EP6CDT);EB*/DV6F*		11/09-12/16	5SEL12	R134a; R1234yf	DCP21022	
1.6 VTi 120	5FS (EP6C)		09/10-12/16	5SEL12	R134a; R1234yf	DCP21021	
1.6 VTi 120	5FS (EP6C);EB*/DV6F*		11/09-12/16	5SEL12	R134a; R1234yf	DCP21022	
1.6 VTi 120 LPG	5FS (EP6C)	For cold climates; For hot climates	09/11-	6SEL16C	R134a	DCP21014	
1.6 VTi 120 LPG	5FS (EP6C)	For mild climatic zones	09/11-	5SEL12	R134a; R1234yf	DCP21021	
1.6 VTi 120 LPG	5FS (EP6C);EB*/DV6F*		09/11-	5SEL12	R134a; R1234yf	DCP21022	
<b>DS3 (09-15)</b>							
1.2 THP 110	HNZ (EB2DT)		10/14-03/15	5SEL12C	R1234yf	DCP21016	9675659880
1.2 THP 110	HNZ (EB2DT)	Ch No: >13852	10/14-07/15	5SEL09C	R134a	DCP21015	
1.2 THP 110	HNZ (EB2DT)	Ch No: >13853	10/14-07/15	5SEL12C	R1234yf	DCP21016	
1.2 VTi 82	HMZ (EB2);HMZ (EB2F)	Ch No: >13852	01/13-10/14	5SEL09C	R134a	DCP21015	
1.2 VTi 82	HMZ (EB2);HMZ (EB2F)	Ch No: >13853	01/13-07/15	5SEL12C	R1234yf	DCP21016	
1.6 THP 165	5GZ (EP6FDT)		10/14-07/15	5SEL09C	R134a	DCP21015	
<b>DS4 (11-15)</b>							
1.2 THP 130	HNY (EB2DTS)		07/14-07/15	5SEL12	R134a; R1234yf	DCP21022	
1.6 BlueHDi 115	BHX (DV6FC)	For cold climates; For mild climate zones	11/14-07/15	5SEL12	R134a; R1234yf	DCP21021	
1.6 BlueHDi 120	BHZ (DV6FC)	For vehicles with start-stop function	07/14-07/15	5SEL12	R134a; R1234yf	DCP21021	9676862380
1.6 BlueHDi 120	BHZ (DV6FC)	For vehicles without start-stop function	07/14-07/15	6SEL16C	R134a	DCP21014	6453WH
1.6 HDi 110	9HR (DV6C)		04/11-07/15	5SEL12	R134a; R1234yf	DCP21021	
1.6 HDi 115	9HD (DV6C)	For cold climates; For hot climates	08/12-07/15	6SEL16C	R134a	DCP21014	
1.6 HDi 115	9HD (DV6C)	For mild climatic zones	08/12-07/15	5SEL12	R134a; R1234yf	DCP21021	
1.6 HDi 90	9HP (DV6DTE)	For cold climates; For hot climates	05/11-07/15	6SEL16C	R134a	DCP21014	
1.6 HDi 90	9HP (DV6DTE)	For mild climatic zones	05/11-07/15	5SEL12	R134a; R1234yf	DCP21021	
1.6 THP 155	5FV (EP6CDT)		04/11-07/15	5SEL12	R134a; R1234yf	DCP21021	
1.6 THP 160	5FM (EP6CDTM)	For hot climate zones	04/12-07/15	6SEL16C	R134a	DCP21014	
1.6 THP 160	5FM (EP6CDTM)	For mild climatic zones	04/12-07/15	5SEL12	R134a; R1234yf	DCP21021	
1.6 THP 165	5FM (EP6CDTM); 5GZ (EP6FDT)		01/12-07/15	5SEL12	R134a; R1234yf	DCP21021	
1.6 THP 200	5FU (EP6DTX)		04/11-07/15	5SEL12	R134a; R1234yf	DCP21021	





				TYPE	GAS	DENSO PN	OE	
<b>CITROËN</b> <i>Continued</i>								
<b>DS4 (11-15)</b> <i>Continued</i>								
1.6 VTi 120	5FS (EP6C)			04/11-07/15	5SEL12	R134a; R1234yf	DCP21021	
2.0 BlueHDi 150	AHX (DW10FD)			07/14-07/15	5SEL12C	R1234yf	DCP21016	
2.0 BlueHDi 180	AHW (DW10FC)			07/14-07/15	5SEL12C	R1234yf	DCP21016	
2.0 HDi 165	RHH (DW10CTED4)			04/11-07/15	5SEL12	R134a; R1234yf	DCP21021	9676862380
<b>DS5 (11-15)</b>								
1.6 BlueHDi 120	BHZ (DV6FC)			07/14-07/15	5SEL12	R134a; R1234yf	DCP21022	
1.6 HDi	BHX (DV6FC)			11/13-07/15	5SEL12	R134a; R1234yf	DCP21021	
1.6 HDi 110	9HR (DV6C)			11/11-07/15	5SEL12	R134a; R1234yf	DCP21021	
1.6 HDi 115	9HD (DV6C)			06/12-07/15	5SEL12	R134a; R1234yf	DCP21021	
1.6 THP 150	5FE (EP6CDTMD)			11/11-07/15	5SEL12	R134a; R1234yf	DCP21021	9676862380
1.6 THP 155	5FV (EP6CDT)			11/11-07/15	5SEL12	R134a; R1234yf	DCP21021	
1.6 THP 200	5FU (EP6DTX)	For hot climate zones		11/11-07/15	6SEL16C	R134a	DCP21014	
1.6 THP 200	5FU (EP6DTX)	For mild climatic zones		11/11-07/15	5SEL12	R134a; R1234yf	DCP21021	
2.0 BlueHDi 150	AHX (DW10FD)			07/14-07/15	5SEL12C	R1234yf	DCP21016	
2.0 BlueHDi 180	AHW (DW10FC)			08/13-07/15	5SEL12C	R1234yf	DCP21016	9675659880
2.0 HDi 135	RHD (DW10CB)			11/11-07/15	5SEL12C	R1234yf	DCP21016	
<b>DAIHATSU</b>								
<b>CHARADE VI (11-)</b>								
1.33 16V	1NR-FE			05/11-12/13	5SER09C	R134a	DCP50304	
<b>CUORE VII (06-)</b>								
1.0	1KR-FE			04/07-02/13	SV07C	R134a	DCP99017	
<b>SIRION (05-)</b>								
1.0	1KR-FE			01/05-08/12	SV07C	R134a	DCP49001	
1.3	K3-VE			01/05-	SV07C	R134a	DCP49001	
1.3 4WD	K3-VE			04/05-08/12	SV07C	R134a	DCP49001	
<b>TERIOS (97-05)</b>								
1.3 4WD	HC-EJ			10/97-02/99	SV07C	R134a	DCP49001	
<b>YRV (01-)</b>								
1.3	K3-VE			02/01-	SCA06E	R134a	DCP49002	88310-97405
1.3 4WD	K3-VE			02/01-	SCA06E	R134a	DCP49002	88310-97405
<b>DAIMLER</b>								
<b>DAIMLER XJ (94-03)</b>								
Six 4.0	AJ26			07/97-12/02	10PA17C	R134a	DCP11003	MCA7300AE
<b>DODGE</b>								
<b>CALIBER (06-)</b>								
1.8	EBA			06/06-12/09	5SE12C	R134a	DCP06022	55111423AI
2.0	ECN			06/06-05/11	5SE12C	R134a	DCP06022	55111423AI
2.0 CRD	ECD			06/06-03/11	5SE12C	R134a	DCP06022	55111423AH
2.4	ED3			10/06-03/11	5SE12C	R134a	DCP06022	55111423AH
2.4 AWD	ED3			10/06-03/11	5SE12C	R134a	DCP06022	55111423AH
2.4 SRT4 AWD	ED4			10/06-03/11	5SE12C	R134a	DCP06022	55111423AH
2.4 Turbo	ED4			12/07-05/11	5SE12C	R134a	DCP06022	5058228AI
<b>CARAVAN (95-02)</b>								
2.5 TD	ENC			01/98-03/01	10PA17C	R134a	DCP99004	
3.3 i	EGP			06/96-06/00	10PA17J	R134a	DCP06006	4677144ABE
3.3 i	EGP	All Climate zones		01/95-03/01	10PA17J	R134a	DCP06005	
3.8 i	EGH			06/96-06/00	10PA17J	R134a	DCP06006	4677144ABE
3.8 i	EGH	All Climate zones		01/95-03/01	10PA17J	R134a	DCP06005	
3.8 i AWD	EGH			06/96-06/00	10PA17J	R134a	DCP06006	4677144ABE
3.8 i AWD	EGH	All Climate zones		01/95-03/01	10PA17J	R134a	DCP06005	
<b>CHARGER (05-10)</b>								
3.5	EGG			01/06-12/06	10S17C	R134a	DCP06027	
<b>JOURNEY (08-)</b>								
2.7	EER	For vehicles with air conditioning front and rear		01/09-05/11	10SR17C	R134a	DCP06029	55111425AA





				TYPE	GAS	DENSO PN	OE
<b>DODGE</b> <i>Continued</i>							
<b>JOURNEY (08-)</b> <i>Continued</i>							
2.7 FLEXFUEL	EER	For vehicles with air conditioning front and rear	01/09-05/11	10SR17C	R134a	DCP06029	55111425AA
3.5	EGF	For vehicles with air conditioning front and rear	06/08-05/11	10SR17C	R134a	DCP06029	55111425AA
3.5 AWD	EGF	For vehicles with air conditioning front and rear	06/08-05/11	10SR17C	R134a	DCP06029	55111425AA
<b>RAM (01-09)</b>							
5.7	EZB		09/02-12/07	10S17E	R134a	DCP06026	
5.7 4WD	EZB		09/02-12/08	10S17E	R134a	DCP06026	
<b>DS</b>							
<b>DS3 (15-)</b>							
1.2 THP 110	HNP (EB2ADT);HNZ (EB2DT)		04/15-	5SEL12C	R1234yf	DCP21016	9675659880
1.2 THP 130	HNY (EB2DTS)		09/15-	5SEL12C	R1234yf	DCP21016	9675659880
1.2 VTi 82	HMZ (EB2);HMZ (EB2F)	Ch No: OPR 14574>	04/15-	5SEL09	R134a; R1234yf	DCP21025	9822184980
<b>DS4 (Crossback) (15-)</b>							
1.2 THP 130	HNY (EB2DTS)		07/15-	5SEL12	R134a; R1234yf	DCP21022	
1.6 BlueHDi 100	BHY (DV6FD)		04/16-	5SEL12	R134a; R1234yf	DCP21022	
1.6 BlueHDi 120	BHZ (DV6FC)		07/15-	5SEL12	R134a; R1234yf	DCP21022	
1.6 THP 165	5GZ (EP6FDT)		07/15-	5SEL12	R134a; R1234yf	DCP21022	
1.6 THP 210	5GM (EP6FDTX)		07/15-	5SEL12	R134a; R1234yf	DCP21022	
2.0 BlueHDi 150	AHR (DW10FD)		07/15-	5SEL12C	R1234yf	DCP21016	9675659880
2.0 BlueHDi 180	AHW (DW10FC)		07/15-	5SEL12C	R1234yf	DCP21016	9675659880
<b>DS5 (15-)</b>							
1.6 BlueHDi 120	BHZ (DV6FC)		06/15-	5SEL12	R134a; R1234yf	DCP21022	
1.6 THP 165	5GZ (EP6FDT)		07/15-	5SEL12	R134a; R1234yf	DCP21022	
1.6 THP 210	5GM (EP6FDTX)		04/15-	5SEL12	R134a; R1234yf	DCP21022	
2.0 BlueHDi 150	AHR (DW10FD)		04/15-	5SEL12C	R1234yf	DCP21016	9675659880
2.0 BlueHDi 180	AHW (DW10FC)		04/15-	5SEL12C	R1234yf	DCP21016	9675659880
<b>FENDT CV</b>							
<b>Farmer (87-03)</b>							
250 S, 250 V	F 3L 912		01/87-12/02	10PA15C	R134a	DCP99502	G311.550.020 .100
250 SA, 250 VA	F 3L 912		01/87-12/02	10PA15C	R134a	DCP99502	G311.550.020 .100
260 P, 260 S, 260 V	F 3L 913		01/87-12/96	10PA15C	R134a	DCP99502	G311.550.020 .100
260 PA, 260 SA, 260 VA	F 3L 913		01/87-12/96	10PA15C	R134a	DCP99502	G311.550.020 .100
270 P, 270 V	F 4L 912		01/88-12/96	10PA15C	R134a	DCP99502	G311.550.020 .100
270 PA, 270 VA	F 4L 912		01/88-12/96	10PA15C	R134a	DCP99502	G311.550.020 .100
275 S, 275 V	F 4L 913		01/88-12/96	10PA15C	R134a	DCP99502	G311.550.020 .100
275 SA, 275 VA	F 4L 913		01/88-12/96	10PA15C	R134a	DCP99502	G311.550.020 .100
280 P	F 4L 913		01/96-12/03	10PA15C	R134a	DCP99502	G311.550.020 .100
280 PA	F 4L 913		01/96-12/03	10PA15C	R134a	DCP99502	G311.550.020 .100
307 A	TD 226 B-3		01/93-12/98	10PA15C	R134a	DCP99502	G311.550.020 .100
307 C	BF 4M 1012 E		01/97-12/03	10PA15C	R134a	DCP99502	G311.550.020 .100
307 CA	BF 4M 1012 E		01/97-12/03	10PA15C	R134a	DCP99502	G311.550.020 .100
307 LS	D 226-4		01/90-12/98	10PA15C	R134a	DCP99502	G311.550.020 .100
307 LS, 307 LSE	TD 226 B-3		01/85-12/93	10PA15C	R134a	DCP99502	G311.550.020 .100
307 LSA	TD 226 B-3		01/85-12/93	10PA15C	R134a	DCP99502	G311.550.020 .100
307 LSA	D 226-4		01/90-12/98	10PA15C	R134a	DCP99502	G311.550.020 .100





				TYPE	GAS	DENSO PN	OE	
<b>FENDT CV</b> <i>Continued</i>								
<b>Farmer (87-03)</b> <i>Continued</i>								
308 C	BF 4M 1012 EC			01/97-12/03	10PA15C	R134a	DCP99502	G311.550.020 .100
308 CA	BF 4M 1012 EC			01/97-12/03	10PA15C	R134a	DCP99502	G311.550.020 .100
308 LS, 308 LSE	TD 226 B-4			01/90-12/00	10PA15C	R134a	DCP99502	G311.550.020 .100
308 LSA	TD 226 B-4			01/90-12/00	10PA15C	R134a	DCP99502	G311.550.020 .100
309 CA	BF 4M 1012 EC			01/97-12/03	10PA15C	R134a	DCP99502	G311.550.020 .100
310 LSA	D 226 B-4;TD 226-4			01/85-12/96	10PA15C	R134a	DCP99502	G311.550.020 .100
310 LSE	D 226 B-4			01/90-12/96	10PA15C	R134a	DCP99502	G311.550.020 .100
311 LSA	D 226 B-6			01/91-12/00	10PA15C	R134a	DCP99502	G311.550.020 .100
311 LSE	D 226 B-6			01/91-12/00	10PA15C	R134a	DCP99502	G311.550.020 .100
312 LSA	D 226 B-6			01/91-12/00	10PA15C	R134a	DCP99502	G311.550.020 .100
<b>Favorit (93-04)</b>								
509 CA	TD 226 B-4			01/94-12/99	10PA15C	R134a	DCP99502	
510 CA	TD 226 B-4			01/93-12/99	10PA15C	R134a	DCP99502	
511 CA	D 226 B-6			01/94-12/99	10PA15C	R134a	DCP99502	
512 CA	TD 226 B-6			01/93-12/99	10PA15C	R134a	DCP99502	
514 CA	TD 226 B-6			01/93-12/99	10PA15C	R134a	DCP99502	
515 CA	TD 226 B-6			01/93-12/99	10PA15C	R134a	DCP99502	
<b>GT (84-98)</b>								
380 GT	F 4L 913			01/84-12/98	10PA15C	R134a	DCP99502	
390 GTA	F 6L 912			01/85-12/95	10PA15C	R134a	DCP99502	
395 GTA	F 6L 913			01/89-12/98	10PA15C	R134a	DCP99502	
<b>GT (96-)</b>								
380 GTA	BF 4L 913 T			01/98-	10PA15C	R134a	DCP99502	
<b>FIAT</b>								
<b>500 (C) (312) (07-)</b>								
0.9	312 A4.000			09/12-08/16	SCSB06C	R134a	DCP09004	
0.9	312 A4.000	For vehicles without automatic climate control		09/12-08/16	SCSB06C	R134a	DCP09004	51747318
0.9	312 A4.000	For vehicles without automatic climate control		09/12-	SCSB06C	R134a; R1234yf	DCP09061	51747318
0.9	312 A4.000; 312 A6.000			12/13-	SCSB06C	R134a; R1234yf	DCP09061	
0.9 TwinAir	199 B6.000			12/13-08/16	SCSB06C	R134a	DCP09004	
0.9 TwinAir	199 B6.000	For vehicles without automatic climate control		10/13-08/16	SCSB06C	R134a	DCP09004	51747318
0.9 TwinAir	199 B6.000	For vehicles without automatic climate control		10/13-	SCSB06C	R134a; R1234yf	DCP09061	51747318
0.9 TwinAir	312 A2.000			09/09-08/16	SCSC06	R134a	DCP09003	51746931
0.9 TwinAir	312 A2.000			09/10-06/12	SCSC06	R134a; R1234yf	DCP09060	51746931
1.2	169 A4.000			07/07-08/16	SCSB06C	R134a	DCP09004	46782669
1.2	169 A4.000			07/07-	SCSB06C	R134a; R1234yf	DCP09061	46782669
1.2 LPG	169 A4.000			12/10-08/16	SCSB06C	R134a	DCP09004	46782669
1.2 LPG	169 A4.000			12/10-	SCSB06C	R134a; R1234yf	DCP09061	46782669
1.3 D Multijet	169 A1.000;199 B1.000;312 B1.000			10/07-08/16	SCSC06	R134a	DCP09003	46819144
1.3 D Multijet	169 A1.000;199 B1.000;312 B1.000; 312 B5.000			10/07-	SCSC06	R134a; R1234yf	DCP09060	
1.4	169 A3.000			10/07-08/16	SCSB06C	R134a	DCP09004	46782669
1.4	169 A3.000;EAB			10/07-	SCSB06C	R134a; R1234yf	DCP09061	
<b>ALBEA / SIENA (96-11)</b>								
1.2	178 B5.000	Ch No: 2369487>		09/98-12/02	SC08C	R134a	DCP09007	46514443
1.2	178 C4.066;188 A4.000;188 A5.000			01/02-12/12	SC08C	R134a	DCP09005	46785772
1.3 JTD	188 A9.000			09/03-01/04	SCSC06	R134a	DCP09003	46819144
1.3 JTD	188 A9.000			09/03-01/04	SCSC06	R134a; R1234yf	DCP09060	46819144
1.4	178 F3.011; 350 A1.000			01/07-12/09	SCSB06C	R134a	DCP09004	











				TYPE	GAS	DENSO PN	OE
<b>FIAT</b> <i>Continued</i>							
<b>BARCETTA (95-05)</b>							
1.8 16V	183 A1.000	Ch No: 58270>	04/95-09/00	TV12SC	R134a	DCP09009	46438366
1.8 16V	188 A6.000		09/00-05/02	SCS08C	R134a	DCP09001	46757907
1.8 16V	188 A6.000		06/02-05/05	SCSC06	R134a	DCP09003	46819144
1.8 16V	188 A6.000		06/02-05/05	SCSC06	R134a; R1234yf	DCP09060	46819144
<b>BRAVA (95-02)</b>							
1.2 16V 80	182 B2.000		12/98-12/02	SC08C	R134a	DCP09007	46514443
1.2 16V 80	188 A5.000		10/00-10/01	SC08C	R134a	DCP09005	46785772
1.4	182 A5.000		10/95-09/98	TV12SC	R134a	DCP09009	46438366
1.4 12 V	182 A3.000		10/95-08/98	TV12SC	R134a	DCP09009	46438366
1.6 16V	182 A4.000;182 A6.000		10/95-10/01	TV12SC	R134a	DCP09006	46438576
1.6 16V	182 B6.000		01/99-03/02	TV12SC	R134a	DCP09006	46438576
1.8 GT 16V	182 A2.000		10/95-07/99	TV12SC	R134a	DCP09009	46438366
1.9 JTD	182 B9.000		09/00-10/01	TV12SC	R134a	DCP09009	46438366
1.9 JTD 105	182 B4.000		12/98-10/01	SCS08C	R134a	DCP09001	46757907
1.9 TD 100 S	182 A7.000		03/96-10/01	TV12SC	R134a	DCP09009	46438366
1.9 TD 75 S	182 A8.000		03/96-10/01	TV12SC	R134a	DCP09009	46438366
<b>BRAVO I (95-01)</b>							
1.2 16V 80	182 B2.000		12/98-10/00	SC08C	R134a	DCP09007	46514443
1.2 16V 80	188 A5.000		10/00-10/01	SC08C	R134a	DCP09005	46785772
1.4	182 A3.000;182 A5.000		10/95-09/98	TV12SC	R134a	DCP09009	46438366
1.6 16V	182 A4.000;182 A6.000		10/95-10/01	TV12SC	R134a	DCP09006	46438576
1.8 GT	182 A2.000		10/95-07/99	TV12SC	R134a	DCP09009	46438366
1.9 JTD	182 B9.000		09/00-10/01	SCS08C	R134a	DCP09001	46757907
1.9 JTD 105	182 B4.000		12/98-10/01	SCS08C	R134a	DCP09001	46757907
1.9 TD 100 S	182 A7.000		03/96-10/01	TV12SC	R134a	DCP09009	46438366
1.9 TD 75 S	182 A8.000		03/96-10/01	TV12SC	R134a	DCP09009	46438366
2.0 HGT 20V	182 A1.000;182 B7.000		10/95-10/01	-	R134a	DCP09011	
<b>BRAVO II (06-14)</b>							
1.4	192 B2.000		04/07-12/14	SCSB06C	R134a	DCP09004	46782669
1.4	192 B2.000		04/07-12/14	SCSB06C	R134a; R1234yf	DCP09061	46782669
1.4 16V	198 A7.000		01/10-05/16	5SL12C	R134a	DCP09020	51794515
1.4 16V	198 A7.000		04/10-12/14	5SL12	R134a; R1234yf	DCP09063	50541343
1.4 LPG	192 B2.000		12/08-12/14	SCSB06C	R134a	DCP09004	51747318
1.4 LPG	192 B2.000		12/08-12/14	SCSB06C	R134a; R1234yf	DCP09061	51747318
1.4 T-Jet	198 A1.000;198 A4.000		09/07-12/09	5SL12C	R134a	DCP09020	51794515
1.4 T-Jet	198 A1.000;198 A4.000		09/07-12/14	5SL12	R134a; R1234yf	DCP09063	50541343
1.4 T-Jet	198 A1.000;198 A4.000		01/10-12/14	SCSB06C	R134a	DCP09004	46782669
1.4 T-Jet	198 A1.000;198 A4.000		01/10-12/14	SCSB06C	R134a; R1234yf	DCP09061	46782669
1.6 D Multijet	198 A2.000;198 A3.000;198 A6.000; 844 A3.000		09/07-12/14	5SL12C	R134a	DCP09017	55701201
1.9 D Multijet	192 A1.000;192 A8.000;192 B4.000; 192 B5.000;937 A5.000		11/06-12/14	5SL12C-J	R134a	DCP09008	46811244
2.0 D Multijet	198 A5.000;198 A8.000;844 A2.000		09/08-12/14	5SL12C	R134a	DCP13010	
<b>COUPE (93-00)</b>							
1.8 16V	183 A1.000		03/96-05/98	TV12SC	R134a	DCP09009	46438366
2.0 20V Turbo	175 A3.000		08/96-08/00	-	R134a	DCP09011	
<b>DOBLO (01-)</b>							
1.2	223 A5.000		03/01-12/05	SC08C	R134a	DCP09007	46514443
1.2	223 A5.000	Ch No: 2369487>	03/01-12/05	SC08C	R134a	DCP09007	46514443
1.3 D Multijet	199 A2.000;223 A9.000		10/05-	SCSC06	R134a	DCP09003	51746931
1.3 D Multijet	199 A2.000;223 A9.000		10/05-	SCSC06	R134a; R1234yf	DCP09060	51746931
1.3 JTD	199 A2.000		05/05-	SCSC06	R134a	DCP09003	51746931
1.3 JTD	199 A2.000		05/05-	SCSC06	R134a; R1234yf	DCP09060	51746931
1.3 JTD 16V	188 A8.000;188 A9.000		05/04-12/06	SCSC06	R134a	DCP09003	46819144;517 46931
1.3 JTD 16V	188 A8.000;188 A9.000		05/04-12/06	SCSC06	R134a; R1234yf	DCP09060	46819144;517 46931
1.4	350 A1.000		10/05-	SCSB06C	R134a	DCP09004	46782669
1.4	350 A1.000		10/05-	SCSB06C	R134a; R1234yf	DCP09061	46782669
1.6 16V	182 B6.000		10/01-12/05	5SL12C-T	R134a	DCP09002	46809223
1.6 Natural Power	182 B6.000		01/04-	5SL12C-T	R134a	DCP09002	46809223
1.9 D	223 A6.000		03/01-12/05	SCS08C	R134a	DCP09001	46757907
1.9 D Multijet	186 A9.000		10/05-	SCS08C	R134a	DCP09001	46757907





				TYPE	GAS	DENSO PN	OE
<b>FIAT</b> <i>Continued</i>							
<b>DOBLO (01-)</b> <i>Continued</i>							
1.9 JTD	182 B9.000;223 A7.000;223 B1.000		10/01-	SCS08C	R134a	DCP09001	46757907
<b>DOBLO (10-)</b>							
1.3 D Multijet	199 A3.000;263 A2.000;263 A6.000		02/10-	-	R134a	DCP09K22	
1.4	198 A4.000;843 A1.000		02/10-	5SL12C	R134a	DCP09016	
1.4	198 A4.000;843 A1.000		02/10-	5SL12	R134a; R1234yf	DCP09062	50541342
1.4 Natural Power	198 A4.000		02/10-	5SL12C	R134a	DCP09016	
1.4 Natural Power	198 A4.000		02/10-	5SL12	R134a; R1234yf	DCP09062	50541342
<b>FIORINO (07-)</b>							
1.3 D Multijet	199 A9.000;199 B1.000;225 A2.000; 330 A1.000		11/07-	-	R134a	DCP09K22	
1.4	350 A1.000		10/09-05/16	5SL12C	R134a	DCP09016	
1.4	350 A1.000		10/09-	5SL12	R134a; R1234yf	DCP09062	50541342
1.4 Natural Power	350 A1.000		06/08-05/16	5SL12C	R134a	DCP09016	
1.4 Natural Power	350 A1.000		06/08-	5SL12	R134a; R1234yf	DCP09062	50541342
<b>Grande PUNTO (05-)</b>							
0.9 TwinAir	312 A2.000		03/12-09/13	5SL12C	R134a	DCP09032	51906240
0.9 TwinAir	312 A2.000		03/12-05/16	5SEL12	R134a	DCP09034	51939001
0.9 TwinAir	312 A2.000		03/12-	5SL12	R134a; R1234yf	DCP09064	50541346
1.2	169 A4.000;199 A4.000		10/05-	5SL12C	R134a	DCP09016	
1.2	169 A4.000;199 A4.000		10/05-	5SL12	R134a; R1234yf	DCP09062	
1.2 LPG	199 A4.000		07/08-	5SL12C	R134a	DCP09016	
1.2 LPG	199 A4.000		07/08-	5SL12	R134a; R1234yf	DCP09062	
1.3 D Multijet	199 A2.000;199 A3.000	Ch No: >1256697	10/05-04/07	5SL12C	R134a	DCP20022	
1.3 D Multijet	199 A2.000;199 A3.000	Ch No: 253778>	05/07-	-	R134a	DCP09K22	
1.3 D Multijet	199 A2.000;199 A9.000;199 B1.000; 199 B2.000;199 B4.000;223 A9.000		04/08-	-	R134a	DCP09K22	
1.4	199 A7.000;350 A1.000		06/05-	5SL12C	R134a	DCP09016	
1.4	199 A7.000;350 A1.000		06/05-	5SL12	R134a; R1234yf	DCP09062	50541342
1.4	350 A1.000		06/05-01/08	5SL12C	R134a	DCP09017	55701201
1.4 16V	199 A6.000		10/05-01/08	SCSB06C	R134a	DCP09004	46782669
1.4 16V	199 A6.000		10/05-01/08	SCSB06C	R134a; R1234yf	DCP09061	46782669
1.4 LPG	350 A1.000		12/08-05/16	5SL12C	R134a	DCP09016	
1.4 LPG	350 A1.000		12/08-	5SL12	R134a; R1234yf	DCP09062	50541342
1.4 Natural Power	350 A1.000		07/08-	5SL12	R134a; R1234yf	DCP09062	50541342
1.4 Natural Power	350 A1.000		10/08-05/16	5SL12C	R134a	DCP09016	
1.4 T-Jet	198 A4.000		09/07-01/08	5SL12C	R134a	DCP09017	55701201
1.4 T-Jet	198 A4.000		09/07-01/08	5SL12C	R134a	DCP09020	51794515
1.4 T-Jet	198 A4.000		09/07-	5SL12	R134a; R1234yf	DCP09063	50541343
1.6 D Multijet	955 A3.000		07/08-12/09	5SL12C	R134a	DCP09017	55701201
1.6 D Multijet	955 A3.000		07/08-12/09	5SL12C	R134a	DCP13005	71789108
1.9 D Multijet	199 A5.000;939 A1.000		01/08-12/09	5SL12C	R134a	DCP13005	71789108
1.9 D Multijet	199 A5.000;939 A1.000;939 A7.000		10/05-01/08	5SL12C	R134a	DCP09017	55701201
<b>IDEA (03-)</b>							
1.2 16V	188 A5.000	Ch No: 998441>	01/04-	SCSB06C	R134a	DCP09004	46782669
1.2 16V	188 A5.000	Ch No: 998441>	01/04-	SCSB06C	R134a; R1234yf	DCP09061	46782669
1.3 D Multijet	188 A9.000;199 A3.000		01/04-	SCSC06	R134a; R1234yf	DCP09060	46819144
1.3 D Multijet	188 A9.000;199 A3.000;199 B1.000		01/04-	SCSC06	R134a	DCP09003	46819144
1.4	192 B2.000	Ch No: 998441>	12/03-	SCSB06C	R134a	DCP09004	46782669
1.4	192 B2.000	Ch No: 998441>	12/03-	SCSB06C	R134a; R1234yf	DCP09061	46782669
1.4	350 A1.000		06/07-	SCSB06C	R134a	DCP09004	46782669
1.4	350 A1.000		06/07-	SCSB06C	R134a; R1234yf	DCP09061	46782669
1.4 16V	843 A1.000	Ch No: 998441>	01/04-	SCSB06C	R134a	DCP09004	46782669
1.4 16V	843 A1.000	Ch No: 998441>	01/04-	SCSB06C	R134a; R1234yf	DCP09061	46782669
1.4 LPG	350 A1.000		03/09-	SCSB06C	R134a	DCP09004	51747318





				TYPE	GAS	DENSO PN	OE
<b>FIAT</b> <i>Continued</i>							
<b>IDEA (03-)</b> <i>Continued</i>							
1.4 LPG	350 A1.000		03/09-	SCSB06C	R134a; R1234yf	DCP09061	51747318
1.6 D Multijet	350 A2.000		05/08-	5SL12C	R134a	DCP09017	55701201
1.9 JTD	188 B2.000		01/04-	SCSC06	R134a	DCP09003	46819144
1.9 JTD	188 B2.000		01/04-	SCSC06	R134a; R1234yf	DCP09060	46819144
<b>LINEA (07-)</b>							
1.3 D Multijet	199 A3.000		06/07-	-	R134a	DCP09K22	51803075
1.4	350 A1.000		06/07-05/16	5SL12C	R134a	DCP09016	
1.4	350 A1.000		06/07-	5SL12	R134a; R1234yf	DCP09062	50541342
1.4 T-Jet	198 A4.000		09/07-12/16	5SL12C	R134a	DCP09020	51794515
1.4 T-Jet	198 A4.000		09/07-	5SL12	R134a; R1234yf	DCP09063	50541343
1.6 D Multijet	198 A3.000		06/09-	5SL12C	R134a	DCP09017	
<b>MAREA (96-07)</b>							
1.2 16V	182 B2.000		02/99-05/02	SC08C	R134a	DCP09007	46514443
1.4 80 12V	182 A3.000		09/96-01/99	TV12SC	R134a	DCP09009	46438366
1.6	185 A3.000		03/99-08/00	TV12SC	R134a	DCP09006	
1.6	182 B6.000		09/00-08/02	5SL12C-T	R134a	DCP09002	46809223
1.6	182 B6.000		09/00-08/02	TV12SC	R134a	DCP09006	46438576
1.6 100 16V	182 A4.000		09/96-05/02	TV12SC	R134a	DCP09006	46438576
1.6 100 16V Bipower	185 A3.000		04/99-05/02	TV12SC	R134a	DCP09006	46438576
1.6 SX	182 B5.098		10/01-08/02	5SL12C-T	R134a	DCP09002	46809223
1.8 115 16V	182 A2.000		09/96-05/02	TV12SC	R134a	DCP09009	46438366
1.9 JTD 105	182 B4.000		12/98-12/02	SCS08C	R134a	DCP09001	
1.9 TD 100	182 A7.000		05/96-01/99	TV12SC	R134a	DCP09009	46438366
1.9 TD 75	182 A8.000		09/96-05/02	TV12SC	R134a	DCP09009	46438366
2.0 150 20V	182 A1.000		09/96-04/99	-	R134a	DCP09011	
2.0 155 20V	182 B7.000		04/99-02/03	-	R134a	DCP09011	
2.4 JTD 130	185 A6.000		04/99-05/02	7SBU16C	R134a	DCP01001	46775094
<b>PALIO (96-)</b>							
1.2	178 B5.000;178 E2.000		09/97-10/02	SC08C	R134a	DCP09007	
1.2	188 A4.000;188 A5.000		07/97-09/02	SC08C	R134a	DCP09005	46785772
1.7 TD	176 A3.000		09/97-03/01	TV14EC	R134a	DCP09015	7736928
1.7 TD	176 A3.000	Ch No: 2282505>	09/97-03/01	TV14EC	R134a	DCP09014	46542431
1.9 D	223 A6.000		03/01-	SCS08C	R134a	DCP09001	46757907;46786262
1.9 JTD	188 A2.000		09/01-09/02	SCS08C	R134a	DCP09001	46786262
<b>PANDA (03-)</b>							
1.1	187 A1.000		09/03-	SCSB06C	R134a	DCP09004	46782669
1.1	187 A1.000		09/03-	SCSB06C	R134a; R1234yf	DCP09061	46782669
1.2	169 A4.000;188 A4.000		09/03-	SCSB06C	R134a	DCP09004	
1.2	169 A4.000;188 A4.000		09/03-	SCSB06C	R134a; R1234yf	DCP09061	46782669
1.2 4x4	169 A4.000;188 A4.000		09/04-	SCSB06C	R134a	DCP09004	
1.2 4x4	169 A4.000;188 A4.000		09/04-	SCSB06C	R134a; R1234yf	DCP09061	51747318
1.2 LPG	169 A4.000;188 A4.000		04/09-	SCSB06C	R134a	DCP09004	
1.2 LPG	169 A4.000;188 A4.000		08/09-12/11	SCSB06C	R134a; R1234yf	DCP09061	46782669
1.2 Natural Power	188 A4.000		01/07-12/11	SCSB06C	R134a	DCP09004	
1.2 Natural Power	188 A4.000		08/09-12/11	SCSB06C	R134a; R1234yf	DCP09061	46782669
1.3 D Multijet	169 A1.000;169 A5.000;188 A8.000		08/09-	SCSC06	R134a	DCP09003	51746931
1.3 D Multijet	169 A1.000;169 A5.000;188 A8.000		08/09-	SCSC06	R134a; R1234yf	DCP09060	51746931
1.3 D Multijet 4x4	169 A1.000;169 A5.000;188 A8.000		01/06-12/11	SCSC06	R134a	DCP09003	51746931
1.3 D Multijet 4x4	169 A1.000;169 A5.000;188 A8.000		01/06-12/11	SCSC06	R134a; R1234yf	DCP09060	51746931
1.4	169 A3.000		08/09-06/10	SCSB06C	R134a	DCP09004	46782669
1.4	169 A3.000		08/09-06/10	SCSB06C	R134a; R1234yf	DCP09061	46782669
1.4 Natural Power	350 A1.000		07/10-12/11	SCSB06C	R134a	DCP09004	51747318
1.4 Natural Power	350 A1.000		07/10-12/11	SCSB06C	R134a; R1234yf	DCP09061	51747318
<b>PANDA (12-)</b>							
0.9	312 A4.000		02/12-08/16	SCSB06C	R134a	DCP09004	
0.9	312 A4.000;312 A6.000		02/12-	SCSB06C	R134a; R1234yf	DCP09061	
0.9 Natural Power	312 A2.000		07/12-08/16	SCSB06C	R134a	DCP09004	

				TYPE	GAS	DENSO PN	OE
<b>FIAT Continued</b>							
<b>PANDA (12-) Continued</b>							
0.9 Natural Power	312 A2.000		07/12-	SCSB06C	R134a; R1234yf	DCP09061	
0.9 TwinAir	312 A2.000;312 A5.000;312 A7.000		02/12-	SCSB06C	R134a; R1234yf	DCP09061	
0.9 TwinAir	312 A2.000;312 A7.000		02/12-08/16	SCSB06C	R134a	DCP09004	
0.9 TwinAir 4x4	312 A2.000		09/12-08/16	SCSB06C	R134a	DCP09004	
0.9 TwinAir 4x4	312 A2.000		09/12-	SCSB06C	R134a; R1234yf	DCP09061	
1.2	169 A4.000		02/12-08/16	SCSB06C	R134a	DCP09004	
1.2	169 A4.000		02/12-	SCSB06C	R134a; R1234yf	DCP09061	
1.2 LPG	169 A4.000		06/12-08/16	SCSB06C	R134a	DCP09004	
1.2 LPG	169 A4.000		06/12-	SCSB06C	R134a; R1234yf	DCP09061	
1.3 D Multijet	199 A9.000;199 B1.000;312 B1.000; 330 A1.000		02/12-	SCSC06	R134a; R1234yf	DCP09060	
1.3 D Multijet	199 A9.000;225 A2.000;312 A8.000; 312 B2.000		02/12-08/16	SCSC06	R134a	DCP09003	
1.3 D Multijet 4x4	199 A9.000;199 B1.000;312 B1.000; 330 A1.000		06/12-	SCSC06	R134a; R1234yf	DCP09060	
1.3 D Multijet 4x4	199 A9.000;225 A2.000;312 A8.000; 312 B2.000		06/12-08/16	SCSC06	R134a	DCP09003	
<b>PUNTO (93-00)</b>							
1.1	176 B2.000		04/96-09/99	SC08C	R134a	DCP09007	46514443
1.1	176 B2.000		04/96-09/99	TV12EC	R134a	DCP09010	7765865
1.1 55	176 A6.000; 176 B2.000		09/93-09/99	TV12EC	R134a	DCP09010	7765865
1.1 55	176 B2.000		10/94-09/99	SC08C	R134a	DCP09007	46514443
1.2 16V	176 B9.000		04/97-09/99	TV12EC	R134a	DCP09010	7765865
1.2 16V	176 B9.000		11/97-09/99	SC08C	R134a	DCP09007	46514443
1.2 16V 85	176 B9.000		04/97-09/99	TV12EC	R134a	DCP09010	7765865
1.2 60	176 A7.000		01/94-04/97	TV12EC	R134a	DCP09010	7765865
1.2 75	176 A8.000		10/93-10/97	TV12EC	R134a	DCP09010	7765865
1.2 75	176 A8.000		11/97-09/99	SC08C	R134a	DCP09007	46514443
1.6	176 A9.000		01/94-04/97	TV14EC	R134a	DCP09012	7741901
1.6 90	176 A9.000		04/94-04/97	TV14EC	R134a	DCP09012	7741901
1.7 D	176 B3.000		10/94-04/97	TV14EC	R134a	DCP09015	7736928
1.7 TD	176 A3.000;176 A5.000;176 B7.000		01/94-09/99	TV14EC	R134a	DCP09015	7736928
60 1.2	176 B1.000;176 B4.000		09/93-09/99	TV12EC	R134a	DCP09010	7765865
60 1.2	176 B4.000		11/97-09/99	SC08C	R134a	DCP09007	46514443
<b>PUNTO (99-12)</b>							
1.2 16V 80	188 A5.000	Ch No: 455412>	09/99-06/03	SC08C	R134a	DCP09005	46785772
1.2 16V 80	188 A5.000	Ch No: 455412>	09/99-06/03	SC08C	R134a	DCP09007	46514443
1.2 16V 80	188 A5.000	Ch No: 616580>	09/99-04/06	SCSB06C	R134a	DCP09004	46782669
1.2 16V 80	188 A5.000	Ch No: 616580>	09/99-04/06	SCSB06C	R134a; R1234yf	DCP09061	46782669
1.2 60	188 A4.000		02/02-06/03	SCSB06C	R134a	DCP09004	46782669
1.2 60	188 A4.000		02/02-06/03	SCSB06C	R134a; R1234yf	DCP09061	46782669
1.2 60	188 A4.000	Ch No: 2574661>	02/02-12/10	SCSB06C	R134a	DCP09004	46782669
1.2 60	188 A4.000	Ch No: 2574661>	02/02-12/10	SCSB06C	R134a; R1234yf	DCP09061	46782669
1.2 60	188 A4.000	Ch No: 9733363>	09/99-01/02	SC08C	R134a	DCP09005	46785772
1.2 60	188 A4.000	Ch No: 9733363>	09/99-06/03	SC08C	R134a	DCP09007	46514443
1.2 Bifuel	188 A4.000		01/08-08/09	SCSB06C	R134a	DCP09004	51747318
1.2 Bifuel	188 A4.000		01/08-08/09	SCSB06C	R134a; R1234yf	DCP09061	51747318
1.2 Natural Power	188 A4.000	Ch No: 2574661>	09/03-03/12	SCSB06C	R134a	DCP09004	46782669
1.2 Natural Power	188 A4.000	Ch No: 2574661>	09/03-03/12	SCSB06C	R134a; R1234yf	DCP09061	46782669
1.3 JTD	188 A9.000		06/03-10/05	SCSC06	R134a	DCP09003	46819144
1.3 JTD	188 A9.000		06/03-10/05	SCSC06	R134a; R1234yf	DCP09060	46819144
1.3 JTD 16V	188 A9.000		06/03-03/12	SCSC06	R134a	DCP09003	46819144
1.3 JTD 16V	188 A9.000		06/03-03/12	SCSC06	R134a; R1234yf	DCP09060	46819144
1.4	843 A1.000		09/03-03/12	SCSB06C	R134a	DCP09004	46782669
1.4	843 A1.000		09/03-03/12	SCSB06C	R134a; R1234yf	DCP09061	46782669





				TYPE	GAS	DENSO PN	OE
<b>FIAT</b> <i>Continued</i>							
<b>PUNTO (99-12)</b> <i>Continued</i>							
1.8 130 HGT	183 A1.000		09/99-06/03	TV12SC	R134a	DCP09009	46438366
1.8 130 HGT	188 A6.000		09/99-05/02	SCS08C	R134a	DCP09001	46757907
1.8 130 HGT	188 A6.000		06/02-03/12	SCSC06	R134a	DCP09003	46819144
1.8 130 HGT	188 A6.000		06/02-03/12	SCSC06	R134a; R1234yf	DCP09060	46819144
1.9 D 60	188 A3.000		02/00-04/02	SCS08C	R134a	DCP09001	46757907
1.9 D 60	188 A3.000		05/02-06/03	SCSC06	R134a	DCP09003	46819144
1.9 D 60	188 A3.000		05/02-06/03	SCSC06	R134a; R1234yf	DCP09060	46819144
1.9 DS 60	188 A3.000		09/99-04/02	SCS08C	R134a	DCP09001	46757907
1.9 DS 60	188 A3.000		05/02-06/03	SCSC06	R134a	DCP09003	46819144
1.9 DS 60	188 A3.000		05/02-06/03	SCSC06	R134a; R1234yf	DCP09060	46819144
1.9 JTD	188 A7.000		10/01-04/02	SCS08C	R134a	DCP09001	46757907
1.9 JTD	188 A7.000;188 B2.000		05/02-03/12	SCSC06	R134a	DCP09003	46819144
1.9 JTD	188 A7.000;188 B2.000		05/02-03/12	SCSC06	R134a; R1234yf	DCP09060	46819144
1.9 JTD 80	188 A2.000		09/99-04/02	SCS08C	R134a	DCP09001	46757907
1.9 JTD 80	188 A2.000		05/02-06/03	SCSC06	R134a	DCP09003	46819144
1.9 JTD 80	188 A2.000		05/02-06/03	SCSC06	R134a; R1234yf	DCP09060	46819144
<b>PUNTO (12-)</b>							
0.9 Twinair	199 B6.000;199 B7.000;312 A2.000		03/12-05/16	5SEL12	R134a	DCP09034	51939001
0.9 Twinair	199 B6.000;199 B7.000;312 A2.000		03/12-	5SL12	R134a; R1234yf	DCP09064	50541346
0.9 TwinAir	312 A2.000		03/12-09/13	5SL12C	R134a	DCP09032	51906240
1.2	169 A4.000		03/12-	5SL12	R134a; R1234yf	DCP09062	50541342
1.2	169 A4.000;199 B9.000		03/12-	5SL12C	R134a	DCP09016	
1.3 D Multijet	199 A2.000;199 A9.000;199 B1.000; 199 B4.000;199 B8.000;330 A1.000		03/12-	-	R134a	DCP09K22	
1.4	199 A7.000;350 A1.000		03/12-05/16	5SL12C	R134a	DCP09016	
1.4	199 A7.000;350 A1.000		03/12-	5SL12	R134a; R1234yf	DCP09062	50541342
1.4 Bifuel	350 A1.000		03/12-05/16	5SL12C	R134a	DCP09016	
1.4 Bifuel	350 A1.000		03/12-	5SL12	R134a; R1234yf	DCP09062	50541342
1.4 MultiAir	955 A2.000;955 A6.000		03/12-05/16	5SL12C	R134a	DCP09020	51794515
1.4 MultiAir	955 A2.000;955 A6.000		03/12-	5SL12	R134a; R1234yf	DCP09063	50541343
1.4 Natural Power	350 A1.000		03/12-05/16	5SL12C	R134a	DCP09016	
1.4 Natural Power	350 A1.000		03/12-	5SL12	R134a; R1234yf	DCP09062	50541342
<b>PUNTO Evo (08-12)</b>							
1.2	169 A4.000;199 A4.000		10/09-02/12	5SL12C	R134a	DCP09016	
1.2	169 A4.000;199 A4.000		10/09-02/12	5SL12	R134a; R1234yf	DCP09062	50541342
1.3 D Multijet	199 A2.000;199 A3.000;199 A9.000; 199 B1.000;199 B2.000;199 B4.000; 223 A9.000		07/08-02/12	-	R134a	DCP09K22	
1.4	199 A7.000;350 A1.000		07/09-02/12	5SL12C	R134a	DCP09016	
1.4	199 A7.000;350 A1.000		07/09-02/12	5SL12	R134a; R1234yf	DCP09062	50541342
1.4 16V	955 A2.000		10/09-02/12	5SL12C	R134a	DCP09020	51794515
1.4 16V	955 A2.000		10/09-02/12	5SL12	R134a; R1234yf	DCP09063	50541343
1.4 16V	955 A6.000		10/09-02/12	5SL12C	R134a	DCP09016	55194880
1.4 16V	955 A6.000		10/09-02/12	5SL12	R134a; R1234yf	DCP09062	50541342
1.4 LPG	350 A1.000		06/09-02/12	5SL12C	R134a	DCP09016	
1.4 LPG	350 A1.000		06/09-02/12	5SL12	R134a; R1234yf	DCP09062	50541342
1.4 Natural Power	350 A1.000		10/09-02/12	5SL12C	R134a	DCP09016	
1.4 Natural Power	350 A1.000		10/09-02/12	5SL12	R134a; R1234yf	DCP09062	50541342
1.6 D Multijet	955 A3.000		10/09-02/12	5SL12C	R134a	DCP09017	55701201
<b>QUJO (08-)</b>							
1.3 D Multijet	199 A2.000;199 A9.000;199 B1.000; 225 A2.000		02/08-	-	R134a	DCP09K22	
1.4	KFT		02/08-05/16	5SL12C	R134a	DCP09016	
1.4	KFT; KfV		02/08-	5SL12	R134a; R1234yf	DCP09062	50541342
1.4	350 A1.000		10/09-05/16	5SL12C	R134a	DCP09016	
1.4 Natural Power	350 A1.000		10/09-05/16	5SL12C	R134a	DCP09016	55194880





				TYPE	GAS	DENSO PN	OE
<b>FIAT</b> <i>Continued</i>							
<b>QUBO (08-)</b> <i>Continued</i>							
1.4 Natural Power	350 A1.000		10/09-	5SL12	R134a; R1234yf	DCP09062	50541342
<b>SEDICI (06-14)</b>							
1.9 D Multijet	D19AA		06/06-06/09	5SL12C	R134a	DCP09017	55701201
1.9 D Multijet 4x4	D19AA		06/06-06/09	5SL12C	R134a	DCP09017	55701201
2.0 D Multijet	D20AA		06/06-07/09	5SL12C	R134a	DCP09017	55701201
2.0 D Multijet 4x4	D20AA		07/09-10/14	5SL12C	R134a	DCP09017	55701201
<b>STILO (01-08)</b>							
1.2 16V	188 A5.000		02/02-12/03	SCSB06C	R134a	DCP09004	46782669
1.2 16V	188 A5.000		02/02-12/03	SCSB06C	R134a; R1234yf	DCP09061	46782669
1.4 16V	192 B2.000		03/05-08/08	SCSB06C	R134a	DCP09004	46782669
1.4 16V	192 B2.000		03/05-08/08	SCSB06C	R134a; R1234yf	DCP09061	46782669
1.4 16V	843 A1.000	Ch No: 998441>	10/03-08/08	SCSB06C	R134a	DCP09004	46782669
1.4 16V	843 A1.000	Ch No: 998441>	10/03-08/08	SCSB06C	R134a; R1234yf	DCP09061	46782669
1.6 16V	182 B6.000		10/01-08/08	5SL12C-T	R134a	DCP09002	46809223
1.6 16V	182 B6.000		01/03-12/03	5SL12C-J	R134a	DCP09008	46811244
1.6 16V	192 B3.000		05/05-11/06	5SL12C-T	R134a	DCP09002	
1.8 16V	192 A4.000		01/03-08/08	5SL12C-J	R134a	DCP09008	46811244
1.9 D Multijet	192 A8.000;192 A9.000;937 A5.000		09/05-08/08	5SL12C-J	R134a	DCP09008	46811244
1.9 JTD	192 A1.000;192 A3.000;192 A5.000; 192 B1.000;192 B5.000;937 A4.000		10/01-08/08	5SL12C-J	R134a	DCP09008	46811244
<b>STRADA (99-)</b>							
1.2	178 B5.000;188 A4.000		06/99-05/06	SC08C	R134a	DCP09007	46514443
1.2	188 A4.000		04/03-05/06	SC08C	R134a	DCP09005	46785772
1.3 D Multijet	223 A9.000		05/06-	SCSC06	R134a	DCP09003	46819144
1.3 D Multijet	223 A9.000		05/06-	SCSC06	R134a; R1234yf	DCP09060	46819144
1.7 TD	176 A3.000		06/99-03/03	TV14EC	R134a	DCP09014	46542431
1.9 D	223 A6.000		12/00-01/06	SCS08C	R134a	DCP09001	46757907
1.9 JTD	188 A2.000		04/03-05/06	SCS08C	R134a	DCP09001	46757907
<b>STRADA (10-)</b>							
1.3 D Multijet	199 B1.000		10/10-	SCSC06	R134a	DCP09003	
<b>FORD</b>							
<b>KA (08-)</b>							
1.2	169 A4.000; AAAA; FP4		10/08-	SCSB06C	R134a	DCP09004	1535408
1.2	169 A4.000; AAAA; FP4		10/08-	SCSB06C	R134a; R1234yf	DCP09061	1535408
1.3 TDCi	1.3 DQ CR TC		10/08-	SCSC06	R134a	DCP09003	1537745
1.3 TDCi	1.3 DQ CR TC		10/08-	SCSC06	R134a; R1234yf	DCP09060	1537745
<b>HONDA</b>							
<b>ACCORD VI (97-05)</b>							
1.8 i	F18B2		10/98-12/02	10S17C	R134a	DCP40002	
2.0	F20B6		12/99-12/02	10S17C	R134a	DCP40002	
2.0 i	F20B6		10/98-01/01	10S17C	R134a	DCP40002	38810-PDA-E 01
2.2 Type-R	H22A7		02/99-12/02	10S17C	R134a	DCP40002	
2.3	F23Z5		11/00-06/03	10S17C	R134a	DCP40002	
<b>ACCORD VII (03-08)</b>							
2.0	K20A6		02/03-05/08	10S17C	R134a	DCP40012	38800-RAA-A 01
2.0 AWD	K20A6		02/03-05/08	10S17C	R134a	DCP40012	38800-RAA-A 01
2.4	K24A;K24A3		02/03-05/08	10S17C	R134a	DCP40012	38800-RAA-A 01
<b>CR-V II (01-06)</b>							
2.2 CTDi	N22A2		02/05-09/06	10S17C	R134a	DCP40003	
<b>CR-V III (06-)</b>							
2.2 i-CTDi 4WD	N22A2		01/07-04/10	10SR15C	R134a	DCP40004	
2.2 i-DTEC 4WD	N22B3		01/10-	10SR15C	R134a	DCP40018	
<b>CR-V IV (12-)</b>							
2.2 i-DTEC 4WD	N22B4		10/12-	10SR15C	R134a	DCP40017	
<b>FR-V (04-)</b>							
2.0	K20A9		02/05-01/07	10S17C	R134a	DCP40015	
<b>HUMMER</b>							
<b>HUMMER H2 (02-)</b>							
6.0 AWD	LQ4(364CUV8)		09/02-09/04	10S17F	R134a	DCP99020	20931258





				TYPE	GAS	DENSO PN	OE
<b>HUMMER</b> <i>Continued</i>							
<b>HUMMER H2 (02-)</b> <i>Continued</i>							
6.0 AWD	LQ4(364CUV8)			09/04-	10S17F	R134a	DCP99020 20931258
<b>INFINITI</b>							
<b>QX56 (10-)</b>							
56 AWD	VK56VD			03/10-	10PA17C	R134a	DCP14002
<b>IVECO</b>							
<b>DAILY III (97-06)</b>							
2.3 29 L 10	F1AE0481A			09/02-04/06	10PA17C	R134a	DCP12003 504014391
2.3 29 L 10 V	F1AE0481A			09/02-07/07	10PA17C	R134a	DCP12003 504014391
2.3 29 L 12	F1AE0481B			09/02-04/06	10PA17C	R134a	DCP12003 504014391
2.3 29 L 12 V	F1AE0481B			09/02-07/07	10PA17C	R134a	DCP12003 504014391
2.3 29 L 14	F1AE0481M			11/05-04/06	10PA17C	R134a	DCP12003
2.3 35 C 10 V , 35 S 10 V	F1AE0481A			09/02-04/06	10PA17C	R134a	DCP12003 504014391
2.3 35 C 12 , 35 S 12	F1AE0481B			09/02-04/06	10PA17C	R134a	DCP12003 504014391
2.3 35 C 12 V, 35 S 12 V	F1AE0481B			09/02-07/07	10PA17C	R134a	DCP12003 504014391
2.3 35 S 10	F1AE0481A			09/02-07/07	10PA17C	R134a	DCP12003 504014391
2.3 D	F1AE0481M			01/05-04/06	10PA17C	R134a	DCP12003
2.8 D	8140.43B;8140.43C;8140.43N;8140.43R; 8140.43S;8140.63			05/99-04/06	SC08C	R134a	DCP12001
2.8 D	8140.43B;8140.43C;8140.43N;8140.43R; 8140.43S;8140.63			05/99-07/07	10PA17C	R134a	DCP12004
2.8 Natural Power	8149.03			05/99-04/06	SC08C	R134a	DCP12001
2.8 Natural Power	8149.03			05/99-07/07	10PA17C	R134a	DCP12004
3.0 D	F1CE0481A;F1CE0481B			09/04-04/06	10PA17C	R134a	DCP12003
<b>DAILY IV (06-11)</b>							
2.3 D	F1AE0481FA;F1AE0481GA	Ch No: >1246924		05/06-08/11	10PA17C	R134a	DCP12003
2.3 D	F1AE0481FA;F1AE0481GA;F1AE0481HA			05/06-06/09	10PA17C	R134a	DCP12003 504014391
2.3 D	F1AE0481GA			07/07-08/11	10S17C	R134a	DCP12012
3.0 D	F1CE0481FA;F1CE0481HA;F1CE0481L; F1CE3481LC			05/06-08/11	10PA17C	R134a	DCP12003 504014391
3.0 D	F1CE0481FA;F1CE0481HA;F1CE3481LC	Ch No: >1246924		05/06-08/11	10PA17C	R134a	DCP12003
3.0 D	F1CE0481HA			09/09-08/11	10S17C	R134a	DCP12012 5801362246
3.0 Natural Power	F1CE0441A			07/07-08/11	10PA17C	R134a	DCP12003
3.0 Natural Power	F1CE0441A	Ch No: >1246924		07/07-08/11	10PA17C	R134a	DCP12003
<b>DAILY V (11-14)</b>							
2.3 D	F1AE3481A;F1AE3481B	Ch No: >1246924		09/11-02/14	10PA17C	R134a	DCP12003 504384698
2.3 D	F1AE3481A;F1AE3481B	Ch No: 1246925>		09/11-02/14	10S17C	R134a	DCP12012 5801362246
2.3 D	F1AE3481A;F1AE3481B;F1AE3481C			09/11-02/14	10S17C	R134a	DCP12012
3.0 D	F1CE3481B;F1CE3481C;F1CE3481D; F1CE3481J;F1CE3481K;F1CE3481L			09/11-02/14	10S17C	R134a	DCP12012
3.0 Natural Power				09/11-02/14	10S17C	R134a	DCP12012
<b>DAILY VI (14-)</b>							
2.3 D	F1AE3481A;F1AE3481B;F1AE3481C; F1AFL411A;F1AFL411B;F1AFL411C; F1AGL411G;F1AGL411H;F1AGL411J			03/14-	10S17C	R134a	DCP12012
3.0 D	F1CE3481D;F1CE3481J;F1CE3481K; F1CFL411E;F1CFL411F;F1CFL411G; F1CFL411H;F1CFL411J			03/14-	10S17C	R134a	DCP12012
3.0 Natural Power	F1CFA401A;F1CFA401B			03/14-	10S17C	R134a	DCP12012
<b>IVECO CV</b>							
<b>EuroStar (93-02)</b>							
LD 190 E 39 P, LD 190 E 39 FP	F3AE0681E			11/99-02/02	10PA17C	R134a	DCP12009
LD 190 E 40	F3AE0681B			09/00-02/02	10PA17C	R134a	DCP12009
LD 190 E 43, LD 190 E 43 P, LD 190 E 43 FP	F3AE0681D			11/99-02/02	10PA17C	R134a	DCP12009
LD 260 E 39 P, LD 260 E 39 FP	F3AE0681E			11/99-02/02	10PA17C	R134a	DCP12009
LD 260 E 40	F3AE0681B			09/00-02/02	10PA17C	R134a	DCP12009
LD 260 E 43 Y/PS, LD 260 E 43 FP	F3AE0681D			01/93-02/02	10PA17C	R134a	DCP12009
LD 440 E 39 T, LD 440 E 39 T/P	F3AE0681E			11/99-02/02	10PA17C	R134a	DCP12009
LD 440 E 39 TX, LD 440 E 39 TX/P	F3AE0681E			11/99-02/02	10PA17C	R134a	DCP12009
LD 440 E 40 T	F3AE0681B			09/00-02/02	10PA17C	R134a	DCP12009
LD 440 E 40 TX/P	F3AE0681B			01/01-02/02	10PA17C	R134a	DCP12009
LD 440 E 43 T/P	F3AE0681D			01/93-02/02	10PA17C	R134a	DCP12009
LD 440 E 43 TX/P	F3AE0681D			11/99-02/02	10PA17C	R134a	DCP12009
<b>EuroTech MH (98-)</b>							
190 E 24 K	F2BE0681D			09/98-	10PA17C	R134a	DCP12009





				TYPE	GAS	DENSO PN	OE
<b>IVECO CV</b> <i>Continued</i>							
<b>EuroTech MH (98-)</b> <i>Continued</i>							
190 E 24, 190 E 24 /P	F2BE0681D			09/98-	10PA17C	R134a	DCP12009
260 E 24 Y/P, 260 E 24 Y/PS, 260 E 24 Y/PT	F2BE0681D			11/99-	10PA17C	R134a	DCP12009
<b>EuroTech MP (92-)</b>							
190 E 39, 190 E 39 /P, 190 E39 /FP	F3AE0681E			11/99-	10PA17C	R134a	DCP12009
190 E 40 /P	F3AE0681B			01/01-	10PA17C	R134a	DCP12009
190 E 43, 190 E 43 /P	F3AE0681D			01/01-	10PA17C	R134a	DCP12009
260 E 39 Y, 260 E 39 Y/P, 260 E 39 Y/FP, 260 E 39 Y/FS	F3AE0681E			11/99-	10PA17C	R134a	DCP12009
260 E 40	F3AE0681B			01/01-	10PA17C	R134a	DCP12009
260 E 43 Y, 260 E 43 Y/P	F3AE0681D			11/99-	10PA17C	R134a	DCP12009
440 E 39 T, 440 E 39 T/P, 440 E 39 T/FP-CT	F3AE0681E			11/99-	10PA17C	R134a	DCP12009
440 E 39 TX/P	F3AE0681E			11/99-	10PA17C	R134a	DCP12009
440 E 40 T/P	F3AE0681B			09/00-	10PA17C	R134a	DCP12009
440 E 40 TX/P	F3AE0681B			01/01-	10PA17C	R134a	DCP12009
440 E 43 T, 440 E 43 T/P	F3AE0681D			11/99-	10PA17C	R134a	DCP12009
440 E 43 TX/P	F3AE0681D			11/99-	10PA17C	R134a	DCP12009
<b>EuroTrakker (93-04)</b>							
MP 180 E 24 W Cursor	F2BE0681D			09/99-11/04	10PA17C	R134a	DCP12008
MP 190 E 24 H Cursor	F2BE0681D			09/99-11/04	10PA17C	R134a	DCP12008
MP 190 E 31 H Cursor	F2BE0681B			09/99-11/04	10PA17C	R134a	DCP12008
MP 190 E 31 W Cursor	F2BE0681B			09/99-11/04	10PA17C	R134a	DCP12008
MP 190 E 35 H Cursor	F2BE0681A			09/99-11/04	10PA17C	R134a	DCP12008
MP 190 E 35 W Cursor	F2BE0681A			09/99-11/04	10PA17C	R134a	DCP12008
MP 260 E 27 H Cursor	F2BE0681B			11/99-11/04	10PA17C	R134a	DCP12008
MP 260 E 31 H Cursor	F2BE0681B			09/99-11/04	10PA17C	R134a	DCP12008
MP 260 E 31 HB Cursor	F2BE0681B			11/99-11/04	10PA17C	R134a	DCP12008
MP 260 E 35 H Cursor	F2BE0681A			01/00-11/04	10PA17C	R134a	DCP12008
MP 260 E 35 W Cursor	F2BE0681A			09/99-11/04	10PA17C	R134a	DCP12008
MP 340 E 35 H Cursor	F2BE0681A			09/99-11/04	10PA17C	R134a	DCP12008
MP 340 E 35 HB Cursor	F2BE0681A			01/01-11/04	10PA17C	R134a	DCP12008
MP 380 E 35 H Cursor	F2BE0681A			01/00-11/04	10PA17C	R134a	DCP12008
MP 380 E 35 W Cursor	F2BE0681A			01/00-11/04	10PA17C	R134a	DCP12008
MP 400 E 35 HT Cursor	F2BE0681A			01/00-11/04	10PA17C	R134a	DCP12008
MP 410 E 35 H Cursor	F2BE0681A			01/00-11/04	10PA17C	R134a	DCP12008
<b>Stralis (02-)</b>							
AD 190S27, AT 190S27	F2BE0681C;F2BE0681F			06/03-	10PA17C	R134a	DCP12008
AD 190S30	F2BE0681E			04/04-	10PA17C	R134a	DCP12008
AD 190S30, AD 190S31, AT 190S31	F2BE0681B; F2BE0681E; F2BE3681C			06/03-	10PA17C	R134a	DCP12008
AD 190S31, AT 190S31	F2BE3681C			04/04-	10PA17C	R134a	DCP12008
AD 190S33, AT 190S33	F2BE3681B			12/06-	10PA17C	R134a	DCP12008
AD 190S35	F2BE0681A			04/04-	10PA17C	R134a	DCP12008
AD 190S35, AT 190S35, AD 190S36, AT 190S36	F2BE0681A; F2BE3681A			06/03-	10PA17C	R134a	DCP12008
AD 190S36, AT 190S36	F2BE3681A			05/07-	10PA17C	R134a	DCP12008
AD 190S40, AT 190S40	F3AE0681B; F3AE0681H			03/03-	10PA17C	R134a	DCP12009
AD 190S42, AT 190S42, AS 190S42	F3AE3681B; F3AE3681D			07/06-	10PA17C	R134a	DCP12009
AD 190S43, AT 190S43	F3AE0681D			06/03-	10PA17C	R134a	DCP12009
AD 190S45, AT 190S45	F3AE3681A			12/06-	10PA17C	R134a	DCP12009
AD 190S46, AT 190S46, AS 190S46	F3AE3681Y			01/13-	10PA17C	R134a	DCP12009
AD 260S27 CNG, AT 260S27 CNG	F2BE0641			01/08-	10PA17C	R134a	DCP12008
AD 260S27, AT 260S27	F2BE0681F			04/04-	10PA17C	R134a	DCP12008
AD 260S30, AT 260S30	F2BE0681E			04/04-	10PA17C	R134a	DCP12008
AD 260S31, AT 260S31	F2BE0681B;F2BE3681C			06/03-	10PA17C	R134a	DCP12008
AD 260S33, AT 260S33	F2BE3681B			12/06-	10PA17C	R134a	DCP12008
AD 260S35, AT 260S35, AD 260S36, AT 260S36	F2BE0681A;F2BE3681A			06/03-	10PA17C	R134a	DCP12008
AD 260S36, AT 260S36	F2BE3681A			07/07-	10PA17C	R134a	DCP12008
AD 260S40, AT 260S40	F3AE0681B;F3AE0681H			06/03-	10PA17C	R134a	DCP12009
AD 260S42, AT 260S42	F3AE3681B			12/06-	10PA17C	R134a	DCP12009
AD 260S42, AT 260S42, AS 260S42	F3AE3681B			05/07-	10PA17C	R134a	DCP12009
AD 260S43, AT 260S43	F3AE0681D			06/03-	10PA17C	R134a	DCP12009
AD 260S45, AT 260S45	F3AE3681A			12/06-	10PA17C	R134a	DCP12009
AD 260S45, AT 260S45, AS 260S45	F3AE3681A			05/07-	10PA17C	R134a	DCP12009











				TYPE	GAS	DENSO PN	OE
<b>IVECO CV</b> <i>Continued</i>							
<b>Stralis (02-) Continued</b>							
AD 320S36	F2BE3681A		01/13-	10PA17C	R134a	DCP12008	
AD 320S42, AT 320S42	F3AE3681D		05/07-	10PA17C	R134a	DCP12009	
AD 320S45, AT 320S45, AD 320S46, AT320S46	F3AE3681A		05/07-	10PA17C	R134a	DCP12009	
AD 440S31, AT 440S31	F2BE0681B		06/03-	10PA17C	R134a	DCP12008	
AD 440S33, AT 440S33	F2BE3681B		12/06-	10PA17C	R134a	DCP12008	
AD 440S40, AT 440S40	F3AE0681B;F3AE0681H		03/03-	10PA17C	R134a	DCP12009	
AD 440S42, AT 440S42	F3AE3681B; F3AE3681D		04/06-	10PA17C	R134a	DCP12009	
AD 440S43, AT 440S43	F3AE0681D		06/03-	10PA17C	R134a	DCP12009	
AD 440S45, AT 440S45	F3AE3681A		12/06-	10PA17C	R134a	DCP12009	
AS 190S40	F3AE0681B; F3AE0681H		02/02-	10PA17C	R134a	DCP12009	
AS 190S43	F3AE0681D		02/02-	10PA17C	R134a	DCP12009	
AS 190S45	F3AE3681A		12/06-	10PA17C	R134a	DCP12009	
AS 260S40	F3AE0681B;F3AE0681H		02/02-	10PA17C	R134a	DCP12009	
AS 260S43	F3AE0681D		02/02-	10PA17C	R134a	DCP12009	
AS 440S40	F3AE0681B;F3AE0681H		02/02-	10PA17C	R134a	DCP12009	
AS 440S42	F3AE3681B;F3AE3681D		05/06-	10PA17C	R134a	DCP12009	
AS 440S42, AT 440S42	F3AE3681B		12/06-	10PA17C	R134a	DCP12009	
AS 440S43	F3AE0681D		02/02-	10PA17C	R134a	DCP12009	
AS 440S45	F3AE3681A		12/06-	10PA17C	R134a	DCP12009	
AS 440S45, AT 440S45	F3AE3681A		12/06-	10PA17C	R134a	DCP12009	
AS 440S46	F3AE3681Y		12/09-	10PA17C	R134a	DCP12009	
AT 440S42	F3AE3681B		07/06-	10PA17C	R134a	DCP12009	
AT 440S43	F3AE0681D		06/03-	10PA17C	R134a	DCP12009	
AT 440S45	F3AE3681A		07/06-	10PA17C	R134a	DCP12009	
<b>JAGUAR</b>							
<b>XF (08-15)</b>							
2.7 D	AJD		03/08-04/15	7SEU17C	R134a	DCP11012	
3.0	AJ6WG		03/08-04/15	7SEU16C	R134a	DCP11011	
3.0	306PS		03/12-04/15	7SEU16C	R134a	DCP11011	
3.0 AWD	306PS		10/12-04/15	7SEU16C	R134a	DCP11011	
<b>XJ (94-97)</b>							
3.2 6	9H		11/94-07/97	10PA17C	R134a	DCP11001	MNA7300AB
4.0 6 Sovereign	9EPG		09/94-07/97	10PA17C	R134a	DCP11001	MNA7300AB
4.0 R Supercharger	9EPD		11/94-07/97	10PA17C	R134a	DCP11001	MNA7300AB
<b>XJ (97-03)</b>							
3.2	AJ32		07/97-05/03	10PA17C	R134a	DCP11002	MCA7300AD
3.2	AJ32		07/97-05/03	10PA17C	R134a	DCP11003	MCA7300AE
4.0	AJ26		07/97-05/03	10PA17C	R134a	DCP11003	MCA7300AE
4.0	AJ26;AJ27S		07/97-05/03	10PA17C	R134a	DCP11002	MCA7300AD
<b>XJ (03-09)</b>							
3.0	AJ-V6		05/03-03/09	7SEU16C	R134a	DCP11045	2W93-19D629-AE
3.6	RG (AJ-V8)		05/03-03/09	7SEU16C	R134a	DCP11010	2W93-19D629-B*
3.6	RG (AJ-V8)		05/03-03/09	7SEU16C	R134a	DCP11011	2W93-19D629-CD
D 2.7	AJD		10/05-03/09	7SEU17C	R134a	DCP11012	
<b>XJ Coupe (73-96)</b>							
4.0	9EPCNA;9LPFRB		05/91-03/96	10PA17C	R134a	DCP11001	
<b>XJSC (85-96)</b>							
4.0	9EPCNA		05/91-09/94	10PA17C	R134a	DCP11001	
<b>XK 8 (96-05)</b>							
4.0	AJEE		07/02-07/05	10PA17C	R134a	DCP11007	3W83-19D629-AB
4.0	AJ-V8-4.0R		02/98-02/04	10PA17C	R134a	DCP11002	MCA7300AD
4.0	AJ-V8-4.0R		02/98-02/04	10PA17C	R134a	DCP11003	MCA7300AE
4.2	AJFR		08/02-12/06	10PA17C	R134a	DCP11007	3W83-19D629-AB
<b>JEEP</b>							
<b>CHEROKEE (XJ) (84-01)</b>							
2.5 TD 4x4	ENC		03/95-12/96	10PA17C	R134a	DCP99004	55036412
2.5 TD 4x4	ENC		01/97-12/97	10PA17C	R134a	DCP99003	
2.5 Tdi 4x4	ENC		10/96-09/01	10PA17C	R134a	DCP99003	
<b>CHEROKEE / LIBERTY (KJ) (01-08)</b>							
2.5 CRD 4x4	R 425 DOHC		09/01-10/04	10S17C	R134a	DCP06025	55037467AA
2.8 CRD 4x4	ENR		11/02-01/08	10S17C	R134a	DCP06025	
<b>COMMANDER (05-10)</b>							
3.0 CRD 4x4	EXL		04/06-12/10	10S17C	R134a	DCP06020	





				TYPE	GAS	DENSO PN	OE
<b>JEEP Continued</b>							
<b>COMPASS (06-)</b>							
2.0 CRD	ECD		08/06-03/11	5SE12C	R134a	DCP06022	55111423AH
2.0 CRD 4x4	ECE		09/06-	5SE12C	R134a	DCP06022	
2.4	ED3; EDG		08/06-03/11	5SE12C	R134a	DCP06022	55111423AH
2.4 4x4	ED3		09/06-03/11	5SE12C	R134a	DCP06022	55111423AH
<b>Grand CHEROKEE I (91-99)</b>							
2.5 TD 4x4	ENC		10/95-04/99	10PA17C	R134a	DCP99003	
2.5 TD Laredo	ENC		10/96-09/98	10PA17C	R134a	DCP99003	
4.0 i 4x4	ERH		10/95-06/98	10PA17C	R134a	DCP99001	55036151
4.0 i 4x4	ERH;MX		01/93-04/99	10PA17C	R134a	DCP99001	55036151
4.0 Laredo	ERH		10/96-09/98	10PA17C	R134a	DCP99001	
5.2 i 4x4	ELF;Y		06/93-04/99	10PA17J	R134a	DCP99002	56006551
5.9 i 4x4	ZOO		06/98-04/99	10PA17J	R134a	DCP99002	56006551
<b>Grand CHEROKEE II (98-05)</b>							
2.7 CRD 4x4	ENF		10/01-09/05	10S17C	R134a	DCP06021	55116839AA
2.7 CRD 4x4	ENF		10/04-09/05	10S17C	R134a	DCP06021	55116839AA
3.1 TD 4x4	EXA		04/99-12/01	10PA17C	R134a	DCP99005	35232010F
<b>Grand CHEROKEE III (05-10)</b>							
3.0 CRD 4x4	EXL		06/05-12/10	10S17C	R134a	DCP06020	
5.7 V8 4x4	EZB		06/05-12/10	10S17C	R134a	DCP06020	
6.1 SRT8 4x4	ESF		03/06-12/10	10S17C	R134a	DCP06020	
<b>PATRIOT (07-)</b>							
2.0 CRD	ECD		02/07-03/11	5SE12C	R134a	DCP06022	55111423AH
2.0 CRD 4x4	ECD		02/07-03/11	5SE12C	R134a	DCP06022	55111423AH
2.4	ED3; EDG		06/09-03/11	5SE12C	R134a	DCP06022	55111423AH
2.4 4x4	ED3; EDG		01/08-03/11	5SE12C	R134a	DCP06022	55111423AH
2.4 Eco + 4x4	ED3		07/08-03/11	5SE12C	R134a	DCP06022	55111423AH
<b>JOHN DEERE CV</b>							
<b>Series 4000</b>							
4520, 4720			-	SCSA06C	R134a	DCP99524	MIA10103
<b>LANCIA</b>							
<b>DEDRA (89-99)</b>							
1.6 16V	182 A4.000		12/97-07/99	TV12SC	R134a	DCP09006	46438576
1.8 16V LE	182 A2.000		03/96-07/99	TV14SC	R134a	DCP01004	
<b>DELTA II (93-99)</b>							
1.6 i.e.	182 A6.000		03/96-08/99	TV12SC	R134a	DCP09006	46438576
1.6 i.e. 16V	182 A4.000		01/96-08/99	TV12SC	R134a	DCP09006	46438576
1.8 i.e. 16V	182 A2.000		03/96-08/99	TV14SC	R134a	DCP01004	
<b>DELTA III (08-14)</b>							
1.4	198 A1.000;198 A4.000		09/08-08/14	5SL12C	R134a	DCP09020	51794515
1.4	198 A1.000;198 A4.000		09/08-08/14	5SL12	R134a; R1234yf	DCP09063	50541343
1.4 16V	198 A7.000		07/10-08/14	5SL12C	R134a	DCP09020	51794515
1.4 16V	198 A7.000		07/10-08/14	5SL12	R134a; R1234yf	DCP09063	50541343
1.4 Bifuel	198 A4.000		07/11-08/14	5SL12C	R134a	DCP09020	51794515
1.4 Bifuel	198 A4.000		07/11-08/14	5SL12	R134a; R1234yf	DCP09063	50541343
1.8	939 B1.000		01/09-08/14	5SL12C	R134a	DCP01015	
1.9 D Multijet	844 A1.000		01/09-08/14	5SL12C	R134a	DCP13010	
2.0 D Multijet	198 A5.000;844 A2.000		09/08-08/14	5SL12C	R134a	DCP13010	
<b>KAPPA (94-01)</b>							
2.0 16V Turbo	838 A4.000		11/96-03/01	6CA17A	R134a	DCP13001	
2.0 20V	838 A1.000;838 A6.000		10/94-10/01	7SBU16C	R134a	DCP01001	46775094
2.0 20V	838 A1.000;838 A6.000		10/94-10/01	6CA17A	R134a	DCP13001	7775422
2.0 20V Turbo	175 A3.000		06/98-10/01	6CA17A	R134a	DCP13001	7775422
2.0 20V Turbo	175 A3.000		01/00-10/01	7SBU16C	R134a	DCP01001	46775094
2.4 20V	838 A2.000		12/98-10/00	7SBU16C	R134a	DCP01001	46775094
2.4 20V	838 A2.000;838 A2.027		08/94-10/01	6CA17A	R134a	DCP13001	7775422
2.4 JTD	838 A8.000		06/98-10/01	6CA17A	R134a	DCP13001	7775422
2.4 T.DS	838 A3.000;838 A7.000		08/94-10/01	6CA17A	R134a	DCP13001	7775422
<b>LYBRA (99-05)</b>							
2.0 20V	182 B7.000;185 A8.000		07/99-10/05	-	R134a	DCP09011	
2.4 JTD	839 A5.000;839 A6.000;841 C.000; AR 32501		07/99-10/05	7SBU16C	R134a	DCP01001	46775094
<b>MUSA (04-12)</b>							
1.3 D Multijet	188 A9.000;199 A3.000;199 B1.000		10/04-09/12	SCSC06	R134a	DCP09003	46819144
1.3 D Multijet	188 A9.000;199 A3.000;199 B1.000		10/04-09/12	SCSC06	R134a; R1234yf	DCP09060	46819144
1.4	192 B2.000;350 A1.000		09/05-09/12	SCSB06C	R134a	DCP09004	46782669





				TYPE	GAS	DENSO PN	OE
<b>LANCIA</b> <i>Continued</i>							
<b>MUSA (04-12)</b> <i>Continued</i>							
1.4	192 B2.000;350 A1.000		09/05-09/12	SCSB06C	R134a; R1234yf	DCP09061	46782669
1.4	843 A 1.000	Ch No: 998441>	10/04-09/12	SCSB06C	R134a	DCP09004	46782669
1.4	843 A 1.000	Ch No: 998441>	10/04-09/12	SCSB06C	R134a; R1234yf	DCP09061	46782669
1.4 LPG	350 A1.000		11/10-04/11	SCSB06C	R134a	DCP09004	51747318
1.4 LPG	350 A1.000		11/10-04/11	SCSB06C	R134a; R1234yf	DCP09061	51747318
1.6 D Multijet	350 A2.000		07/08-04/11	5SL12C	R134a	DCP09017	55701201
1.9 D Multijet	188 B2.000		10/04-09/12	SCSC06	R134a	DCP09003	46819144
1.9 D Multijet	188 B2.000		10/04-09/12	SCSC06	R134a; R1234yf	DCP09060	46819144
<b>THESIS (02-09)</b>							
2.0 Turbo	841 E.000		07/02-12/05	7SBU16C	R134a	DCP01001	46775094
2.4	841 D.000		07/02-12/05	7SBU16C	R134a	DCP01001	46775094
2.4 D Multijet	841 P.000		04/06-07/09	7SBU16C	R134a	DCP01001	46775094
2.4 JTD	841 C.000;841 G.000;841 N.000		07/02-07/09	7SBU16C	R134a	DCP01001	46775094
<b>Y (95-03)</b>							
1.1	176 B2.000		04/97-08/00	SC08C	R134a	DCP09007	46514443
1.2	188 A4.000		09/00-01/02	SC08C	R134a	DCP09005	46785772
1.2	188 A4.000		02/02-09/03	SCSB06C	R134a	DCP09004	46782669
1.2	188 A4.000		02/02-09/03	SCSB06C	R134a; R1234yf	DCP09061	46782669
1.2	840 A3.000		03/96-10/97	TV12EC	R134a	DCP09010	7765865
1.2	840 A3.000		11/97-08/00	SC08C	R134a	DCP09007	46514443
1.2 16V	176 B9.000		04/97-10/97	TV12EC	R134a	DCP09010	7765865
1.2 16V	176 B9.000		11/97-08/00	SC08C	R134a	DCP09007	46514443
1.2 16V	188 A5.000		10/00-01/02	SC08C	R134a	DCP09005	46785772
1.2 16V	188 A5.000		02/02-09/03	SCSB06C	R134a	DCP09004	46782669
1.2 16V	188 A5.000		02/02-09/03	SCSB06C	R134a; R1234yf	DCP09061	46782669
1.4 12V	840 A2.000;840 A4.000		03/96-08/00	TV12SC	R134a	DCP09009	46438366
<b>YPSILON (312/846) (11-)</b>							
0.9 CNG	312 A2.000		05/11-08/16	SCSB06C	R134a	DCP09004	
0.9 TwinAir	312 A2.000		05/11-08/16	SCSB06C	R134a	DCP09004	
1.2	169 A4.000		05/11-08/16	SCSB06C	R134a	DCP09004	
1.2	169 A4.000		05/11-	SCSB06C	R134a; R1234yf	DCP09061	
1.2 BiFuel	169 A4.000		05/11-08/16	SCSB06C	R134a	DCP09004	
1.2 BiFuel	169 A4.000		05/11-	SCSB06C	R134a; R1234yf	DCP09061	
1.3 D Multijet	199 B1.000; 312 B1.000		05/11-08/16	SCSC06	R134a	DCP09003	
<b>YPSILON (843) (03-11)</b>							
1.2	169 A4.000;188 A4.000;188 A5.000		10/03-12/11	SCSB06C	R134a	DCP09004	46782669
1.2	169 A4.000;188 A4.000;188 A5.000		10/03-12/11	SCSB06C	R134a; R1234yf	DCP09061	46782669
1.3 D Multijet	199 A2.000;199 A3.000		09/06-12/11	SCSC06	R134a	DCP09003	46819144
1.3 D Multijet	199 A2.000;199 A3.000		09/06-12/11	SCSC06	R134a; R1234yf	DCP09060	46819144
1.3 JTD	188 A9.000		10/03-12/11	SCSC06	R134a	DCP09003	46819144
1.3 JTD	188 A9.000		10/03-12/11	SCSC06	R134a; R1234yf	DCP09060	46819144
1.4	350 A1.000		02/06-12/11	SCSB06C	R134a	DCP09004	
1.4	350 A1.000		02/06-12/11	SCSB06C	R134a; R1234yf	DCP09061	
1.4 16V	843 A 1.000		10/03-12/11	SCSB06C	R134a	DCP09004	46782669
1.4 16V	843 A 1.000		10/03-12/11	SCSB06C	R134a; R1234yf	DCP09061	46782669
1.4 LPG	350 A1.000		11/10-12/11	SCSB06C	R134a	DCP09004	
1.4 LPG	350 A1.000		11/10-12/11	SCSB06C	R134a; R1234yf	DCP09061	
<b>LAND ROVER</b>							
<b>DEFENDER (90-16)</b>							
2.5 Td5 4x4	10 P;14 P;15 P		06/98-02/16	10PA17C	R134a	DCP14006	
3.9 V8 4x4	37 L		11/98-02/16	10PA17C	R134a	DCP14001	
<b>DISCOVERY I (89-98)</b>							
2.0 16 V 4x4	20 T4H		06/89-03/94	10PA17C	R134a	DCP14003	BTR4719
2.5 D 4x4	19 L		01/96-10/98	10PA17C	R134a	DCP14002	BTR4717
2.5 TDI 4x4	12 L; 17 L; 19 L; 21 L		10/89-10/98	10PA17C	R134a	DCP11001	MNA7300AB
2.5 TDI 4x4	12 L; 17 L; 19 L; 21 L		10/89-10/98	10PA17C	R134a	DCP14002	BTR4717
3.5 4x4	22 D		10/92-06/94	10PA17C	R134a	DCP14001	

				TYPE	GAS	DENSO PN	OE
<b>LAND ROVER</b> <i>Continued</i>							
<b>DISCOVERY I (89-98)</b> <i>Continued</i>							
4.0 4x4	35 D; 36 D			09/93-10/98	10PA17C	R134a	DCP14001
<b>DISCOVERY II (98-04)</b>							
2.5 Td5 4x4	10 P; 15 P			11/98-06/04	10PA17C	R134a	DCP14006
4.0 V8 4x4	35 D; 56 D; 94 D			11/98-06/04	10PA17C	R134a	DCP14006
<b>DISCOVERY III (04-09)</b>							
2.7 TD 4x4	276DT			11/04-06/09	7SEU17C	R134a	DCP14014
4.0 4x4				02/05-09/09	7SEU17C	R134a	DCP14012
4.0 V6 4x4	406PN			10/04-09/09	7SEU17C	R134a	DCP14012
4.4 4x4	448PN			07/04-09/09	7SEU17C	R134a	DCP14013
<b>DISCOVERY IV (09-)</b>							
2.7 TD 4x4	276DT			09/09-	7SEU17C	R134a	DCP14020
<b>FREELANDER I (98-06)</b>							
1.8 16V 4x4	18 K4F			09/03-09/06	7SBU16C	R134a	DCP24004
1.8 i 16V 4x4	18 K4F			02/98-08/00	7SBU16C	R134a	DCP24004
1.8 i 16V 4x4	18 K4F	Ch No: >YA552573		02/98-08/00	10PA17C	R134a	DCP14004
1.8 i 16V 4x4	18 K4F	Ch No: YA552574>		02/98-08/00	10S17C	R134a	DCP14008
2.0 DI 4x4	20 T2N	Ch No: >YA552573		02/98-10/06	10PA17C	R134a	DCP14005
2.0 DI 4x4	20 T2N	Ch No: YA552574>		02/98-11/00	10S17C	R134a	DCP14007
2.0 Td4 4x4	204D3;M 47			11/00-10/06	7SBU16C	R134a	DCP24005
2.5 V6 4x4	25 K4F			11/00-10/06	7SBU16C	R134a	DCP14018
<b>RANGE ROVER I (70-95)</b>							
3.9 Cat 4x4	37 D; 38 D			10/92-07/94	10PA17C	R134a	DCP14001
3.9 Vogue SEI 4x4	35 D; 36 D			10/92-07/94	10PA17C	R134a	DCP14001
4.3 Vogue LSE 4x4	40 D			09/92-07/94	10PA17C	R134a	DCP14001
<b>RANGE ROVER II (94-02)</b>							
2.5 D 4x4	25 6T (BMW)			07/94-03/02	10PA17C	R134a	DCP05010
3.9 4x4	42 D	Ch No: XA410482>		07/94-03/02	10PA17C	R134a	DCP14006
4.0 4x4	42 D	Ch No: XA410482>		01/95-03/02	10PA17C	R134a	DCP14006
4.6 4x4	46 D	Ch No: XA410482>		07/94-03/02	10PA17C	R134a	DCP14006
4.6 4x4	46 D;60 D	Ch No: XA410482>		09/95-03/02	10PA17C	R134a	DCP14006
<b>RANGE ROVER Sport (05-13)</b>							
2.7 D 4x4	276DT			06/05-08/09	7SEU17C	R134a	DCP14014
3.6 D 4x4	368DT			04/06-07/10	7SEU17C	R134a	DCP14019
4.2 4x4	428PS			06/05-08/09	7SEU17C	R134a	DCP14013
4.4 4x4	448PN			02/05-03/13	7SEU17C	R134a	DCP14013
<b>LEXUS</b>							
<b>CT (10-)</b>							
200h	2ZR-FXE; 5ZR-FXE			12/10-	ES27	R134a	DCP51011
<b>ES (12-)</b>							
250	2AR-FE			06/12-06/18	TSE17C	R134a	DCP50101
300h	2AR-FXE			06/12-06/18	ES27	R134a	DCP51012
<b>GS (05-11)</b>							
300	3GR-FSE			04/05-11/11	6SBU16C	R134a	DCP51002
350 AWD	2GR-FSE			09/06-11/11	6SBU16C	R134a	DCP51002
450h	2GR-FSE			02/06-05/08	Old ES27	R134a	DCP51005
450h	2GR-FSE			06/08-07/09	Old ES27	R134a	DCP51006
460	1UR-FSE			09/07-11/11	7SEH17C	R134a	DCP51004
<b>GS (12-)</b>							
300h	2AR-FXE			10/13-	ES27	R134a	DCP51012
450h	2GR-FXE			01/12-	ES27	R134a	DCP51012
<b>IS C (09-)</b>							
250	4GR-FSE			04/09-06/15	6SBU16C	R134a	DCP51002
<b>IS I (99-05)</b>							
200	1G-FE			04/99-10/05	10S15C	R134a	DCP51000
<b>IS II (05-13)</b>							
200d	2AD-FTV			07/10-07/12	6SEU16C	R134a	DCP51001
220d	2AD-FHV			08/05-08/08	6SEU16C	R134a	DCP51001
250	4GR-FSE			08/05-08/08	6SEU16C	R134a	DCP51001
250	4GR-FSE			08/05-03/13	6SBU16C	R134a	DCP51002
250 AWD	4GR-FSE			11/10-03/13	6SBU16C	R134a	DCP51002
IS F	2UR-GSE			11/07-03/13	7SEH17C	R134a	DCP51004





				TYPE	GAS	DENSO PN	OE
<b>LEXUS</b> <i>Continued</i>							
<b>IS III (13-)</b>							
300h	2AR-FXE		04/13-	ES27	R134a	DCP51012	88370-33020
<b>LS (00-06)</b>							
430	3UZ-FE		08/00-08/06	6SEU16C	R134a	DCP51003	
<b>LS (06-)</b>							
460	1UR-FE;1UR-FSE		04/06-	7SEH17C	R134a	DCP51004	
460 AWD	1UR-FSE		12/08-	7SEH17C	R134a	DCP51004	
<b>LX (98-08)</b>							
470	2UZ-FE		05/98-03/08	10PA20C	R134a	DCP50087	88320-60680; 88320-60681
470	2UZ-FE	For vehicles with A/C	05/98-03/08	10PA20C	R134a	DCP50087	88320-6068*
<b>RC (14-)</b>							
300h	2AR-FSE		09/14-	ES27	R134a	DCP51012	
<b>RX (98-03)</b>							
300	1MZ-FE		01/98-02/03	10S17C	R134a	DCP51015	
300 AWD	1MZ-FE		01/98-05/03	10S17C	R134a	DCP51015	
<b>RX (03-08)</b>							
350 AWD	2GR-FE		02/06-12/08	6SBU16C	R134a	DCP51016	
400h	3MZ-FE		09/05-12/08	ES27	R134a	DCP51008	
400h AWD	3MZ-FE		09/04-12/08	ES27	R134a	DCP51008	
<b>RX (08-15)</b>							
450h	2GR-FXE		12/08-03/12	ES27	R134a	DCP51007	88370-48030
450h AWD	2GR-FXE		12/08-10/15	ES27	R134a	DCP51007	88370-48030
<b>RX (15-)</b>							
450h AWD	2GR-FXS		11/15-	ES27	R134a	DCP51012	
<b>MAZDA</b>							
<b>RX 8 (03-12)</b>							
1.3	13B-MSP		10/03-06/12	SCSA06C	R134a	DCP44010	
<b>MERCEDES-BENZ</b>							
<b>190 (W201) (82-93)</b>							
D 2.0	OM 601.911		12/83-08/93	10PA15C	R134a	DCP17013	
E 1.8	M 102.910		04/90-08/93	10PA15C	R134a	DCP17012	
E 2.0	M 102.924		08/83-05/90	10P15C	R134a	DCP17001	A0002302411
E 2.0	M 102.924	Ch No: 014540;059561 >	08/83-05/90	10PA15C	R134a	DCP17012	A1021310001
E 2.0	M 102.962		10/82-08/93	10PA15C	R134a	DCP17012	A0002301111
E 2.0	M 102.962	Ch No: 120388>	10/82-08/93	10P15C	R134a	DCP17001	A0002302411
E 2.3	M 102.985		09/86-08/93	10P15C	R134a	DCP17001	A0002302411
E 2.3	M 102.985		09/86-08/93	10PA15C	R134a	DCP17012	A1021310001
E 2.3	M 102.985		09/87-09/88	10P15C	R134a	DCP17001	A0002302411
E 2.3	M 102.985		09/87-09/88	10PA15C	R134a	DCP17012	A1021310001
E 2.3-16	M 102.983		08/84-08/88	10P15C	R134a	DCP17001	
E 2.5-16	M 102.991		03/89-08/93	10PA15C	R134a	DCP17012	
E 2.6	M 103.942		09/86-08/93	10P15C	R134a	DCP17001	A0002302411
E 2.6	M 103.942	Ch No: 032713;032787 >	09/86-08/93	10PA15C	R134a	DCP17012	A1021310001
Turbo-D 2.5	OM 602.961		02/88-08/93	10P15C	R134a	DCP17001	
Turbo-D 2.5	OM 602.961		02/88-08/93	10PA15C	R134a	DCP17012	
Turbo-D 2.5	OM 602.961	Ch No: 000492;004247 >	02/88-08/93	10PA15C	R134a	DCP17012	A1021310001
<b>A-CLASS (W168) (97-04)</b>							
A 140	M 166.940		07/97-06/03	6SEU12C	R134a	DCP17025	A0002302111
A 140	M 166.940		07/03-08/04	6SEU14C	R134a	DCP17050	A0002309411
A 140	M 166.960		01/01-06/03	6SEU12C	R134a	DCP17025	A0002302111
A 140	M 166.960		07/03-08/04	6SEU14C	R134a	DCP17050	A0002309411
A 160	M 166.960		07/97-06/03	6SEU12C	R134a	DCP17025	A0002302111
A 160	M 166.960		07/03-08/04	6SEU14C	R134a	DCP17050	A0002309411
A 160 CDI	OM 668.940		07/03-08/04	6SEU14C	R134a	DCP17050	A0002309411
A 160 CDI	OM 668.940;OM 668.941		07/98-06/03	6SEU12C	R134a	DCP17025	A0002302111
A 170 CDI	OM 668.940;OM 668.942		07/98-06/03	6SEU12C	R134a	DCP17025	A0002302111
A 170 CDI	OM 668.942		07/03-08/04	6SEU14C	R134a	DCP17050	A0002309411
A 190	M 166.990		03/99-06/03	6SEU12C	R134a	DCP17025	A0002302111
A 190	M 166.990		07/03-08/04	6SEU14C	R134a	DCP17050	A0002309411
A 210	M 166.995		12/01-06/03	6SEU12C	R134a	DCP17025	A0002302111
A 210	M 166.995		07/03-08/04	6SEU14C	R134a	DCP17050	A0002309411
<b>A-CLASS (W169) (04-12)</b>							
A 150	M 266.920		09/04-03/08	6SEU16C	R134a	DCP17070	





				TYPE	GAS	DENSO PN	OE	
<b>MERCEDES-BENZ</b> <i>Continued</i>								
<b>A-CLASS (W169) (04-12)</b> <i>Continued</i>								
A 160	M 266.920			04/09-06/12	6SEU16C	R134a	DCP17106	A0022306811
A 160	M 266.920	For vehicles with automatic climate control		04/09-06/12	6SEU16C	R134a	DCP17070	A0012303511
A 160 CDI	OM 640.942			09/04-06/12	6SEU16C	R134a	DCP17071	
A 170	M 266.940			09/04-03/08	6SEU16C	R134a	DCP17070	
A 180	M 266.940			04/09-06/12	6SEU16C	R134a	DCP17106	A0022306811
A 180	M 266.940	For vehicles with automatic climate control		04/09-06/12	6SEU16C	R134a	DCP17070	A0012303511
A 180 CDI	OM 640.940			09/04-06/12	6SEU16C	R134a	DCP17071	
A 200	M 266.960			09/04-06/12	6SEU16C	R134a	DCP17070	
A 200 CDI	OM 640.941			09/04-06/12	6SEU16C	R134a	DCP17071	
A 200 Turbo	M 266.980			04/08-06/12	6SEU16C	R134a	DCP17070	
<b>A-CLASS (W176) (12-)</b>								
A 180 CDI / d 1.8	OM 651.901			06/12-12/12	6SBU16C	R134a	DCP17168	
A 200 CDI / d 1.8	OM 651.901			06/12-12/12	6SBU16C	R134a	DCP17168	
A 220 CDI	OM 651.930			09/12-12/12	6SBU16C	R134a	DCP17168	
A 220 CDI 4-matic	OM 651.930			02/14-12/12	6SBU16C	R134a	DCP17168	
A 220 d	OM 651.930			07/15-05/18	6SBU16C	R134a	DCP17168	A0038304160
<b>B-CLASS (W242, W246) (11-)</b>								
B 180	M 270.910			11/11-12/18	6SEU16C	R134a	DCP17164	
B 180 CDI / d 1.8	OM 651.901			11/11-09/14	6SEU16C	R134a	DCP17158	
B 200	M 270.910			11/11-12/18	6SEU16C	R134a	DCP17164	
B 200 CDI / d 1.8	OM 651.901			11/11-09/14	6SEU16C	R134a	DCP17158	
B 200 Natural Gas Drive / B 200 c	M 270.920			11/12-12/17	6SEU16C	R134a	DCP17167	
B 220 4-matic	M 270.920			05/13-12/18	6SEU16C	R134a	DCP17167	
B 220 CDI / d	OM 651.930			11/11-10/14	6SBU16C	R134a	DCP17168	
B 250	M 270.920			05/12-12/18	6SEU16C	R134a	DCP17167	
B 250 4-matic	M 270.920			08/14-12/18	6SEU16C	R134a	DCP17167	
<b>B-CLASS (W245) (05-11)</b>								
B 150	M 266.920			03/05-03/08	6SEU16C	R134a	DCP17070	A0012303511
B 150	M 266.920			03/05-03/08	6SEU16C	R134a	DCP17071	A0012303611
B 160	M 266.920			04/09-11/11	6SEU16C	R134a	DCP17070	
B 170	M 266.940			03/05-03/08	6SEU16C	R134a	DCP17070	A0012303511
B 170	M 266.940			03/05-03/08	6SEU16C	R134a	DCP17071	A0012303611
B 170 NGT	M 266.960			04/08-11/11	6SEU16C	R134a	DCP17070	
B 180	M 266.940			04/09-11/11	6SEU16C	R134a	DCP17070	
B 180 CDI	OM 640.940			03/05-03/08	6SEU16C	R134a	DCP17071	
B 180 NGT	M 266.960			04/08-11/11	6SEU16C	R134a	DCP17070	
B 200	M 266.960			03/05-03/08	6SEU16C	R134a	DCP17070	A0012303511
B 200	M 266.960			03/05-03/08	6SEU16C	R134a	DCP17071	A0012303611
B 200 CDI	OM 640.941			03/05-11/11	6SEU16C	R134a	DCP17071	
B 200 TURBO	M 266.980			03/05-03/08	6SEU16C	R134a	DCP17070	A0012303511
B 200 TURBO	M 266.980			03/05-03/08	6SEU16C	R134a	DCP17071	A0012303611
<b>CABRIOLET (A124) (92-93)</b>								
300 CE-24	M 104.980			04/92-06/93	10PA17C	R134a	DCP17010	
<b>C-CLASS (202) (93-01)</b>								
C 36 AMG	M 104.941 (AMG 3.6)			09/94-05/00	6CA17C	R134a	DCP17014	A0002301311
C 36 AMG	M 104.941 (AMG 3.6)	Ch No: 006070>		09/94-05/00	7SBU16C	R134a	DCP17023	A0002302011
C 43 AMG	M 113.944			08/97-03/01	6CA17C	R134a	DCP17014	A0002301311
C 43 AMG	M 113.944			08/97-03/01	7SBU16C	R134a	DCP17023	A0002302011
C 180	M 111.920; M 111.921	Ch No: 181392>		03/93-05/00	7SBU16C	R134a	DCP17023	
C 180	M 111.920; M 111.921			03/93-05/00	6CA17C	R134a	DCP17014	
C 180	M 111.921			11/94-05/00	7SBU16C	R134a	DCP17023	
C 180 T	M 111.920; M 111.921			06/96-09/00	6CA17C	R134a	DCP17014	2303911;2302011
C 180 T	M 111.920; M 111.921			06/96-09/00	7SBU16C	R134a	DCP17023	2301311;2307011
C 180 T	M 111.952	Ch No: 181392>		09/00-03/01	7SBU16C	R134a	DCP17023	
C 200	M 111.941; M 111.945			01/94-05/00	6CA17C	R134a	DCP17014	A0002301311
C 200	M 111.941; M 111.945	Ch No: 028944;034155>		01/94-05/00	7SBU16C	R134a	DCP17023	A0002302011
C 200 CDI	OM 611.960			07/98-05/00	6CA17C	R134a	DCP17014	A0002301311
C 200 CDI	OM 611.960			07/98-05/00	7SBU16C	R134a	DCP17023	A0002302011
C 200 D	OM 601.913;OM 604.915			03/93-05/00	6CA17C	R134a	DCP17014	A0002301311
C 200 D	OM 604.915			10/96-05/00	7SBU16C	R134a	DCP17023	A0002302011





				TYPE	GAS	DENSO PN	OE	
<b>MERCEDES-BENZ</b> <i>Continued</i>								
<b>C-CLASS (202) (93-01)</b> <i>Continued</i>								
C 200 Kompressor	M 111.944			10/95-05/00	6CA17C	R134a	DCP17014	A0002301311
C 200 Kompressor	M 111.944			10/95-05/00	7SBU16C	R134a	DCP17023	A0002302011
C 200 T	M 111.941; M 111.945			06/96-03/01	6CA17C	R134a	DCP17014	A0002301311
C 200 T	M 111.941; M 111.945			06/96-03/01	7SBU16C	R134a	DCP17023	A0002302011
C 200 T	M 111.941; M 111.945			06/96-03/01	6SBU16C	R134a	DCP17179	A0008302700
C 200 T CDI	OM 611.960			03/98-10/00	7SBU16C	R134a	DCP17023	
C 200 T D	OM 604.915			10/96-03/01	6CA17C	R134a	DCP17014	A0002301311
C 200 T D	OM 604.915			10/96-03/01	7SBU16C	R134a	DCP17023	A0002302011
C 200 T Kompressor	M 111.944			11/96-03/01	6CA17C	R134a	DCP17014	A0002301311
C 200 T Kompressor	M 111.944			11/96-03/01	7SBU16C	R134a	DCP17023	A0002302011
C 200 T Kompressor	M 111.956	Ch No: 181392>		09/00-03/01	7SBU16C	R134a	DCP17023	
C 220	M 111.961			03/93-05/00	6CA17C	R134a	DCP17014	A0002301311
C 220	M 111.961	Ch No: 024581;084260 >		03/93-05/00	7SBU16C	R134a	DCP17023	A0002302011
C 220 CDI	OM 611.960			03/98-05/00	6CA17C	R134a	DCP17014	A0002301311
C 220 CDI	OM 611.960			03/98-05/00	7SBU16C	R134a	DCP17023	A0002302011
C 220 D	OM 604.910			08/93-05/00	6CA17C	R134a	DCP17014	A0002301311
C 220 D	OM 604.910			07/96-07/99	7SBU16C	R134a	DCP17023	A0002302011
C 220 D	OM 604.910	Ch No: 011549;057399 >		08/93-05/00	7SBU16C	R134a	DCP17023	A0002302011
C 220 T CDI	OM 611.960			09/97-03/01	6CA17C	R134a	DCP17014	A0002301311
C 220 T CDI	OM 611.960	Ch No: 057399>		09/97-03/01	7SBU16C	R134a	DCP17023	A0002302011
C 220 T D	OM 604.910			06/96-03/01	6CA17C	R134a	DCP17014	A0002301311
C 220 T D	OM 604.910	Ch No: 011549;057399 >		06/96-03/01	7SBU16C	R134a	DCP17023	A0002302011
C 230	M 111.974			06/96-06/97	6CA17C	R134a	DCP17014	A0002301311
C 230	M 111.974			06/96-06/97	7SBU16C	R134a	DCP17023	A0002302011
C 230 Kompressor	M 111.975			10/95-05/00	6CA17C	R134a	DCP17014	A0002301311
C 230 Kompressor	M 111.975			10/95-05/00	7SBU16C	R134a	DCP17023	A0002302011
C 230 T	M 111.974			06/96-06/98	6CA17C	R134a	DCP17014	A0002301311
C 230 T	M 111.974			06/96-06/98	7SBU16C	R134a	DCP17023	A0002302011
C 230 T Kompressor	M 111.975			06/97-09/00	6CA17C	R134a	DCP17014	A0002301311
C 230 T Kompressor	M 111.975			06/97-09/00	7SBU16C	R134a	DCP17023	A0002302011
C 240	M 112.910			06/97-05/00	6CA17C	R134a	DCP17014	A0002301311
C 240	M 112.910			06/97-05/00	7SBU16C	R134a	DCP17023	A0002302011
C 240 T	M 112.910			06/97-09/00	6CA17C	R134a	DCP17014	A0002301311
C 240 T	M 112.910			06/97-09/00	7SBU16C	R134a	DCP17023	A0002302011
C 240 T	M 112.915			09/00-03/01	6CA17C	R134a	DCP17014	A0002301311
C 240 T	M 112.915			09/00-03/01	7SBU16C	R134a	DCP17023	A0002302011
C 240 T	M 112.915			09/00-03/01	6SBU16C	R134a	DCP17179	A0008302700
C 250 D	OM 605.910			05/93-07/95	6CA17C	R134a	DCP17014	A0002301311
C 250 D	OM 605.910			05/93-05/00	7SBU16C	R134a	DCP17023	A0002302011
C 250 T Turbo-D	OM 605.960			06/96-03/01	6CA17C	R134a	DCP17014	A0002301311
C 250 T Turbo-D	OM 605.960			06/96-03/01	7SBU16C	R134a	DCP17023	A0002302011
C 250 Turbo-D	OM 605.960			10/95-05/00	6CA17C	R134a	DCP17014	A0002301311
C 250 Turbo-D	OM 605.960			10/95-05/00	7SBU16C	R134a	DCP17023	A0002302011
C 280	M 104.941	Ch No: 006070;063709 >		05/93-05/00	7SBU16C	R134a	DCP17023	A0002302011
C 280	M 104.941;M 112.920			05/93-05/00	6CA17C	R134a	DCP17014	A0002301311
C 280	M 112.920			06/97-05/00	7SBU16C	R134a	DCP17023	A0002302011
C 280 T	M 112.920			06/97-03/01	6CA17C	R134a	DCP17014	A0002301311
C 280 T	M 112.920			06/97-03/01	7SBU16C	R134a	DCP17023	A0002302011
<b>C-CLASS (203) (00-07)</b>								
C 30 CDI AMG	OM 612.990			01/03-08/07	7SEU17C	R134a	DCP17026	
C 30 CDI AMG	OM 612.990			01/03-08/07	7SEU17C	R134a	DCP17040	A0012301411
C 30 CDI AMG	OM 612.990			01/04-08/07	7SEU17C	R134a	DCP17053	A0012305611
C 30 CDI AMG	OM 612.990	All Climate zones		01/03-08/07	7SEU17C	R134a	DCP17119	
C 32 AMG Kompressor	M 112.961			02/01-12/03	7SEU16C	R134a	DCP17153	
C 55 AMG	M 113.988			02/04-02/07	7SEU17C	R134a	DCP17026	
C 55 AMG	M 113.988			02/04-02/07	7SEU17C	R134a	DCP17040	A0012301411
C 55 AMG	M 113.988			02/04-08/07	7SEU17C	R134a	DCP17053	
C 55 AMG	M 113.988	All Climate zones		02/04-02/07	7SEU17C	R134a	DCP17119	
C 180	M 111.951			10/00-05/02	7SEU17C	R134a	DCP17026	A0002305111
C 180	M 111.951			10/00-05/02	7SEU17C	R134a	DCP17040	A0012301411



				TYPE	GAS	DENSO PN	OE
<b>MERCEDES-BENZ</b> <i>Continued</i>							
<b>C-CLASS (203) (00-07)</b> <i>Continued</i>							
C 180	M 111.951		10/00-05/02	7SEU17C	R134a	DCP17043	A0012300011
C 180	M 111.951	All Climate zones	10/00-05/02	7SEU17C	R134a	DCP17119	
C 180 Kompressor	M 271.946		05/02-08/07	7SEU17C	R134a	DCP17108	A0012302611
C 180 Kompressor	M 271.946	For vehicles with automatic climate control	05/02-08/07	7SEU17C	R134a	DCP17038	
C 200 CDI	OM 611.962;OM 646.962		03/01-12/03	7SEU17C	R134a	DCP17043	A0012300011
C 200 CDI	OM 611.962;OM 646.962;OM 646.963		09/00-08/07	7SEU17C	R134a	DCP17026	
C 200 CDI	OM 611.962;OM 646.962;OM 646.963		09/00-08/07	7SEU17C	R134a	DCP17040	A0012301411
C 200 CDI	OM 611.962;OM 646.962;OM 646.963	All Climate zones	09/00-08/07	7SEU17C	R134a	DCP17119	
C 200 CDI	OM 646.962; OM 646.963		01/04-08/07	7SEU17C	R134a	DCP17053	A0012305611
C 200 CGI Kompressor	M 271.942		07/03-08/07	7SEU17C	R134a	DCP17038	
C 200 CGI Kompressor	M 271.942		07/03-08/07	7SEU17C	R134a	DCP17108	A0012302611
C 200 CGI Kompressor	M 271.942	For vehicles with automatic climate control	07/03-02/07	7SEU17C	R134a	DCP17038	
C 200 Kompressor	M 271.940		05/02-08/07	7SEU17C	R134a	DCP17108	A0012302611
C 200 Kompressor	M 271.940	For vehicles with automatic climate control	05/02-08/07	7SEU17C	R134a	DCP17038	
C 200 Kompressor	M 111.955		05/00-06/02	7SEU17C	R134a	DCP17026	A0002305111
C 200 Kompressor	M 111.955		05/00-06/02	7SEU17C	R134a	DCP17040	A0012301411
C 200 Kompressor	M 111.955		05/00-06/02	7SEU17C	R134a	DCP17043	A0012300011
C 200 Kompressor	M 111.955	All Climate zones	05/00-06/02	7SEU17C	R134a	DCP17119	
C 220 CDI	OM 611.962		03/01-12/03	7SEU17C	R134a	DCP17043	A0012300011
C 220 CDI	OM 611.962;OM 646.963		05/00-08/07	7SEU17C	R134a	DCP17026	
C 220 CDI	OM 611.962;OM 646.963		05/00-08/07	7SEU17C	R134a	DCP17040	A0012301411
C 220 CDI	OM 611.962;OM 646.963	All Climate zones	05/00-08/07	7SEU17C	R134a	DCP17119	
C 220 CDI	OM 646.963		02/04-08/07	7SEU17C	R134a	DCP17053	A0012305611
C 230	M 272.920		01/05-08/07	7SEU17C	R134a	DCP17053	
C 230 Kompressor	M 271.948		02/04-02/07	7SEU17C	R134a	DCP17038	
C 230 Kompressor	M 271.948		02/04-02/07	7SEU17C	R134a	DCP17108	A0012302611
C 230 Kompressor	M 271.948		02/04-08/07	7SEU17C	R134a	DCP17053	
C 240	M 112.912		05/00-02/07	7SEU17C	R134a	DCP17026	A0002305111
C 240	M 112.912		05/00-02/07	7SEU17C	R134a	DCP17043	A0012300011
C 240	M 112.912		05/00-08/07	7SEU17C	R134a	DCP17040	A0012301411
C 240	M 112.912		01/04-08/07	7SEU17C	R134a	DCP17053	A0012305611
C 240	M 112.912	All Climate zones	05/00-08/07	7SEU17C	R134a	DCP17119	
C 240 4-matic	M 112.916		07/02-02/07	7SEU17C	R134a	DCP17026	A0002305111
C 240 4-matic	M 112.916		07/02-02/07	7SEU17C	R134a	DCP17043	A0012300011
C 240 4-matic	M 112.916		07/02-08/07	7SEU17C	R134a	DCP17040	A0012301411
C 240 4-matic	M 112.916		01/04-08/07	7SEU17C	R134a	DCP17053	A0012305611
C 240 4-matic	M 112.916	All Climate zones	07/02-08/07	7SEU17C	R134a	DCP17119	
C 270 CDI	OM 612.962		12/00-12/03	7SEU17C	R134a	DCP17043	A0012300011
C 270 CDI	OM 612.962		12/00-07/05	7SEU17C	R134a	DCP17026	A0002305111
C 270 CDI	OM 612.962		12/00-08/07	7SEU17C	R134a	DCP17040	A0012301411
C 270 CDI	OM 612.962		01/04-07/05	7SEU17C	R134a	DCP17053	A0012305611
C 270 CDI	OM 612.962	All Climate zones	12/00-08/07	7SEU17C	R134a	DCP17119	
C 280	M 272.940		07/05-08/07	7SEU17C	R134a	DCP17053	
C 280 4-matic	M 272.941		06/05-08/07	7SEU17C	R134a	DCP17053	
C 320	M 112.946		05/00-02/07	7SEU17C	R134a	DCP17026	A0002305111
C 320	M 112.946		05/00-02/07	7SEU17C	R134a	DCP17043	A0012300011
C 320	M 112.946		05/00-08/07	7SEU17C	R134a	DCP17040	A0012301411
C 320	M 112.946		01/04-08/07	7SEU17C	R134a	DCP17053	A0012305611
C 320	M 112.946	All Climate zones	05/00-08/07	7SEU17C	R134a	DCP17119	
C 320 4-matic	M 112.953		07/02-02/07	7SEU17C	R134a	DCP17026	A0002305111
C 320 4-matic	M 112.953		07/02-02/07	7SEU17C	R134a	DCP17043	A0012300011
C 320 4-matic	M 112.953		07/02-08/07	7SEU17C	R134a	DCP17040	A0012301411
C 320 4-matic	M 112.953		01/04-08/07	7SEU17C	R134a	DCP17053	A0012305611
C 320 4-matic	M 112.953	All Climate zones	07/02-08/07	7SEU17C	R134a	DCP17119	
C 320 CDI	OM 642.910		06/05-08/07	7SEU17C	R134a	DCP17053	
C 350	M 272.960		07/05-08/07	7SEU17C	R134a	DCP17053	
C 350 4-matic	M 272.960;M 272.970		07/05-08/07	7SEU17C	R134a	DCP17053	
<b>C-CLASS (204) (07-14)</b>							
C 63 AMG	M 156.985		02/08-08/14	6SBU16C	R134a	DCP17165	











				TYPE	GAS	DENSO PN	OE
<b>MERCEDES-BENZ</b> <i>Continued</i>							
<b>C-CLASS (204) (07-14)</b> <i>Continued</i>							
C 180	M 274.910		02/12-08/14	6SBU16C	R134a	DCP17155	
C 180 CDI	OM 651.913		01/11-01/14	6SBU16C	R134a	DCP17154	12305011
C 180 CDI	OM 651.913		01/11-08/14	6SBU16C	R134a	DCP17165	
C 180 CDI	OM 651.913		01/11-08/14	6SBU16C	R134a	DCP17179	A0008302700
C 180 CGI	M 274.910		01/08-01/14	6SBU16C	R134a	DCP17155	
C 180 CGI	M 271.820		01/07-08/14	6SEU16C	R134a	DCP17112	A0032304811
C 180 CGI	M 271.820		11/09-08/14	6SBU16C	R134a	DCP17140	A0032308511
C 180 Kompressor	M 271.910		01/08-02/11	6SEU16C	R134a	DCP17101	
C 180 Kompressor	M 271.952		05/07-02/11	6SEU16C	R134a	DCP17101	A0022303011
C 180 Kompressor	M 271.952		05/07-02/11	6SEU16C	R134a	DCP17115	A0012304911
C 200 CDI	OM 651.913		08/10-08/14	6SBU16C	R134a	DCP17165	
C 200 CDI	OM 651.913		08/10-08/14	6SBU16C	R134a	DCP17179	A0008302700
C 200 CDI	OM 646.811		05/07-02/11	6SEU16C	R134a	DCP17087	
C 200 CDI	OM 646.812		10/08-12/09	6SBU16C	R134a	DCP17165	
C 200 CGI	M 271.820;M 271.860		01/07-08/14	6SEU16C	R134a	DCP17112	32304811
C 200 CGI	M 271.820;M 271.860		03/11-08/14	6SBU16C	R134a	DCP17140	32308511
C 200 Kompressor	M 271.950		01/07-02/11	6SEU16C	R134a	DCP17101	A0022303011
C 200 Kompressor	M 271.950		01/07-02/11	6SEU16C	R134a	DCP17115	A0012304911
C 220 CDI	OM 651.911		10/08-08/14	6SBU16C	R134a	DCP17165	
C 220 CDI	OM 651.911		10/08-08/14	6SBU16C	R134a	DCP17179	A0008302700
C 220 CDI	OM 646.811		01/07-11/08	6SEU16C	R134a	DCP17087	
C 220 CDI 4-matic	OM 651.912		02/13-01/14	6SEU16C	R134a	DCP17156	
C 220 CDI 4-matic	OM 651.912		02/13-01/14	6SBU16C	R134a	DCP17179	A0008302700
C 220 CDI 4-matic	OM 651.912		02/13-08/14	6SBU16C	R134a	DCP17165	
C 230	M 272.921		01/07-06/07	6SEU16C	R134a	DCP17087	
C 230	M 272.921		01/07-08/14	6SBU16C	R134a	DCP17165	A0008302500
C 230 4-matic	M 272.911		07/07-01/14	6SBU16C	R134a	DCP17165	
C 250 CDI	OM 651.911		08/08-08/14	6SBU16C	R134a	DCP17165	
C 250 CDI	OM 651.911		08/08-08/14	6SBU16C	R134a	DCP17179	A0008302700
C 250 CDI 4-matic	OM 651.912		04/10-08/14	6SBU16C	R134a	DCP17154	
C 250 CDI 4-matic	OM 651.912		04/10-08/14	6SEU16C	R134a	DCP17156	A0008302500
C 250 CDI 4-matic	OM 651.912		01/11-01/14	6SBU16C	R134a	DCP17179	A0008302700
C 250 CGI	M 271.860		07/09-08/14	6SEU16C	R134a	DCP17112	32304811
C 250 CGI	M 271.860		03/11-08/14	6SBU16C	R134a	DCP17140	32308511
C 280	M 272.947		01/07-06/07	6SEU16C	R134a	DCP17087	
C 280	M 272.947		01/07-08/14	6SBU16C	R134a	DCP17165	A0008302500
C 280 4-matic	M 272.948		07/07-01/14	6SBU16C	R134a	DCP17165	
C 300	M 272.947		08/07-08/14	6SBU16C	R134a	DCP17165	
C 300	M 276.957		02/11-01/14	6SBU16C	R134a	DCP17165	
C 300	M 276.957		02/11-01/14	6SBU16C	R134a	DCP17177	A0008302300
C 300	M 276.957		02/11-01/14	6SBU16C	R134a	DCP17179	A0008302700
C 300 4-matic	M 272.948		07/07-01/14	6SBU16C	R134a	DCP17165	
C 300 4-matic	M 276.957		02/11-01/14	6SBU16C	R134a	DCP17165	
C 300 4-matic	M 276.957		02/11-01/14	6SBU16C	R134a	DCP17177	A0008302300
C 300 CDI 4-matic	OM 642.832		01/11-01/14	6SEU16C	R134a	DCP17104	
C 320 CDI	OM 642.960		01/07-01/14	6SEU16C	R134a	DCP17067	A0012308611
C 320 CDI	OM 642.960		01/07-01/14	6SEU16C	R134a	DCP17086	A0012307911
C 320 CDI	OM 642.960		01/07-01/14	7SEU17C	R134a	DCP17102	A0012301311
C 320 CDI	OM 642.960		05/07-09/07	6SEU16C	R134a	DCP17128	A0012305111
C 320 CDI	OM 642.960		08/07-02/11	6SEU16C	R134a	DCP17104	A0022303211
C 320 CDI	OM 642.960	All Climate zones	01/07-01/14	7SEU17C	R134a	DCP17090	
C 320 CDI 4-matic	OM 642.961		07/07-01/14	6SBU16C	R134a	DCP17165	
C 320 CDI 4-matic	OM 642.961		08/07-02/11	6SEU16C	R134a	DCP17104	
C 350	M 272.961		01/07-06/07	6SEU16C	R134a	DCP17087	
C 350	M 272.961;M 276.957		01/07-08/14	6SBU16C	R134a	DCP17165	A0008302500
C 350	M 276.957		01/11-01/14	6SBU16C	R134a	DCP17177	A0008302300
C 350	M 276.957		01/11-01/14	6SBU16C	R134a	DCP17179	A0008302700
C 350 4-matic	M 272.971		07/07-01/14	7SEU17C	R134a	DCP17053	
C 350 4-matic	M 272.971;M 276.957		07/07-01/14	6SBU16C	R134a	DCP17165	A0008302500
C 350 4-matic	M 276.957		01/11-01/14	6SBU16C	R134a	DCP17177	A0008302300
C 350 CDI	OM 642.830;OM 642.834		10/09-08/14	6SEU16C	R134a	DCP17104	
C 350 CDI 4-matic	OM 642.832		10/09-02/11	6SEU16C	R134a	DCP17104	
C 350 CDI 4-matic	OM 642.961		07/09-01/14	6SBU16C	R134a	DCP17165	
C 350 CGI	M 272.982;M 276.957		09/08-08/14	6SEU16C	R134a	DCP17159	A0022307311
C 350 CGI	M 272.982;M 276.957		09/08-08/14	6SBU16C	R134a	DCP17165	A0008302500
C 350 CGI	M 276.957		06/11-08/14	6SBU16C	R134a	DCP17177	A0008302300
C 350 CGI	M 276.957		06/11-08/14	6SBU16C	R134a	DCP17179	A0008302700
<b>C-CLASS Coupe (C204) (11-)</b>							
C 63 AMG	M 156.985		06/11-	6SBU16C	R134a	DCP17165	





				TYPE	GAS	DENSO PN	OE
<b>MERCEDES-BENZ</b> <i>Continued</i>							
<b>C-CLASS Coupe (C204) (11-)</b> <i>Continued</i>							
C 180	M 274.910			01/13-	6SBU16C	R134a	DCP17155
C 180	M 271.820			06/11-	6SEU16C	R134a	DCP17071
C 180	M 271.820			06/11-	6SBU16C	R134a	DCP17140
C 200 CGI	M 271.860			06/11-	6SEU16C	R134a	DCP17071
C 200 CGI	M 271.860			06/11-	6SBU16C	R134a	DCP17140
C 220 CDI	OM 651.911			06/11-	6SBU16C	R134a	DCP17165
C 220 CDI	OM 651.911			06/11-	6SBU16C	R134a	DCP17179
C 250	M 271.860			06/11-	6SEU16C	R134a	DCP17112
C 250	M 271.860			06/11-	6SBU16C	R134a	DCP17140
C 250 CDI	OM 651.911			06/11-	6SBU16C	R134a	DCP17148
C 250 CDI	OM 651.911			06/11-	6SBU16C	R134a	DCP17165
							22305011; 22303111; 8302500
C 250 CDI	OM 651.911			06/11-	6SBU16C	R134a	DCP17179
C 250 CDI	OM 651.911			01/12-	6SBU16C	R134a	DCP17155
							8302600
C 350	M 276.957			06/11-	6SBU16C	R134a	DCP17165
C 350	M 276.957			06/11-	6SBU16C	R134a	DCP17177
C 350	M 276.957			06/11-	6SBU16C	R134a	DCP17179
C 350 4-matic	M 276.957			09/13-	6SEU16C	R134a	DCP17100
<b>C-CLASS Coupe (CL203) (01-08)</b>							
C 30 CDI AMG	OM 612.990			09/02-05/08	7SEU17C	R134a	DCP17040
C 30 CDI AMG	OM 612.990	All Climate zones		09/02-05/08	7SEU17C	R134a	DCP17119
C 30 CDI AMG	OM 612.990	For vehicles with automatic climate control		09/02-05/08	7SEU17C	R134a	DCP17026
C 160 Kompressor	M 271.921			05/02-05/08	7SEU17C	R134a	DCP17108
C 160 Kompressor	M 271.921			01/04-05/08	7SEU17C	R134a	DCP17038
C 180	M 111.951			03/01-05/02	7SEU17C	R134a	DCP17026
C 180	M 111.951			03/01-05/02	7SEU17C	R134a	DCP17040
C 180	M 111.951			03/01-05/02	7SEU17C	R134a	DCP17043
C 180	M 111.951	All Climate zones		03/01-05/02	7SEU17C	R134a	DCP17119
C 180 Kompressor	M 271.946			05/02-05/08	7SEU17C	R134a	DCP17108
C 180 Kompressor	M 271.946	For vehicles with automatic climate control		05/02-05/08	7SEU17C	R134a	DCP17038
C 200 CDI	OM 646.962			03/03-05/08	7SEU17C	R134a	DCP17040
C 200 CDI	OM 646.962			01/04-05/08	7SEU17C	R134a	DCP17026
C 200 CDI	OM 646.962	All Climate zones		03/03-05/08	7SEU17C	R134a	DCP17119
C 200 CGI Kompressor	M 271.942			03/03-05/08	7SEU17C	R134a	DCP17108
C 200 CGI Kompressor	M 271.942			01/04-05/08	7SEU17C	R134a	DCP17038
C 200 Kompressor	M 271.940			05/02-05/08	7SEU17C	R134a	DCP17108
C 200 Kompressor	M 271.940	For vehicles with automatic climate control		05/02-05/08	7SEU17C	R134a	DCP17038
C 200 Kompressor	M 111.955			03/01-05/02	7SEU17C	R134a	DCP17026
C 200 Kompressor	M 111.955			03/01-05/02	7SEU17C	R134a	DCP17040
C 200 Kompressor	M 111.955			03/01-05/02	7SEU17C	R134a	DCP17043
C 200 Kompressor	M 111.955	All Climate zones		03/01-05/02	7SEU17C	R134a	DCP17119
C 220 CDI	OM 611.962			03/01-12/03	7SEU17C	R134a	DCP17043
C 220 CDI	OM 611.962;OM 646.963			03/01-05/08	7SEU17C	R134a	DCP17026
C 220 CDI	OM 611.962;OM 646.963			03/01-05/08	7SEU17C	R134a	DCP17040
C 220 CDI	OM 611.962;OM 646.963	All Climate zones		03/01-05/08	7SEU17C	R134a	DCP17119
C 230	M 272.920			01/05-05/08	7SEU17C	R134a	DCP17053
C 230 Kompressor	M 271.948			05/02-05/08	7SEU17C	R134a	DCP17108
C 230 Kompressor	M 271.948	For vehicles with automatic climate control		05/02-05/08	7SEU17C	R134a	DCP17038
C 230 Kompressor	M 111.981			03/01-05/02	7SEU17C	R134a	DCP17026
C 230 Kompressor	M 111.981			03/01-05/02	7SEU17C	R134a	DCP17040
C 230 Kompressor	M 111.981			03/01-05/02	7SEU17C	R134a	DCP17043
C 230 Kompressor	M 111.981	All Climate zones		03/01-05/02	7SEU17C	R134a	DCP17119
C 320	M 112.946			09/02-05/08	7SEU17C	R134a	DCP17026
C 320	M 112.946			09/02-05/08	7SEU17C	R134a	DCP17040
C 320	M 112.946			09/02-05/08	7SEU17C	R134a	DCP17043
C 320	M 112.946	All Climate zones		09/02-05/08	7SEU17C	R134a	DCP17119
C 350	M 272.960			01/05-05/08	7SEU17C	R134a	DCP17053





				TYPE	GAS	DENSO PN	OE
<b>MERCEDES-BENZ</b> <i>Continued</i>							
<b>CLC (CL203) (08-11)</b>							
CLC 160	M 271.911		02/09-06/11	7SEU17C	R134a	DCP17038	
CLC 180 Kompressor	M 271.946		05/08-06/11	7SEU17C	R134a	DCP17038	
CLC 200 CDI	OM 646.962		05/08-06/11	7SEU17C	R134a	DCP17053	
CLC 200 Kompressor	M 271.957		05/08-06/11	7SEU17C	R134a	DCP17038	
CLC 220 CDI	OM 646.963		05/08-06/11	7SEU17C	R134a	DCP17053	
CLC 230	M 272.920		05/08-06/11	7SEU17C	R134a	DCP17053	
CLC 350	M 272.960		05/08-06/11	7SEU17C	R134a	DCP17053	
<b>CLK (208) (97-02)</b>							
CLK 55 AMG	M 113.981;M 113.984		08/99-03/02	7SBU16C	R134a	DCP17023	
CLK 200	M 111.941;M 111.945		06/97-03/02	6CA17C	R134a	DCP17014	A0002301311
CLK 200	M 111.941;M 111.945		06/97-03/02	7SBU16C	R134a	DCP17023	A0002302011
CLK 200 Kompressor	M 111.944;M 111.956		06/97-03/02	6CA17C	R134a	DCP17014	A0002301311
CLK 200 Kompressor	M 111.944;M 111.956		06/97-03/02	7SBU16C	R134a	DCP17023	A0002302011
CLK 230 Kompressor	M 111.975;M 111.982		06/97-03/02	10PA17C	R134a	DCP17011	A1191300015
CLK 230 Kompressor	M 111.975;M 111.982		06/97-03/02	7SBU16C	R134a	DCP17023	A0002302011
CLK 320	M 112.940		06/97-03/02	7SBU16C	R134a	DCP17023	
CLK 430	M 113.943		07/98-03/02	7SBU16C	R134a	DCP17023	
<b>CLK (209) (02-10)</b>							
CLK 55 AMG	M 113.987		06/02-06/09	7SEU17C	R134a	DCP17026	
CLK 55 AMG	M 113.987		06/02-03/10	7SEU17C	R134a	DCP17040	A0012301411
CLK 55 AMG	M 113.987	All Climate zones	06/02-03/10	7SEU17C	R134a	DCP17119	
CLK 55 AMG	M 113.987	Ch No: F033015>	06/02-06/09	7SEU17C	R134a	DCP17160	12301611
CLK 63 AMG	M 156.982		04/06-03/10	7SEU17C	R134a	DCP17038	
CLK 200 CGI	M 271.942		07/03-05/09	7SEU17C	R134a	DCP17108	A0012302611
CLK 200 CGI	M 271.942		07/03-03/10	7SEU17C	R134a	DCP17038	
CLK 200 Kompressor	M 271.940		09/02-03/10	7SEU17C	R134a	DCP17108	A0012302611
CLK 200 Kompressor	M 271.940;M 271.955		09/02-03/10	7SEU17C	R134a	DCP17038	
CLK 220 CDI	OM 646.966		06/05-05/09	7SEU17C	R134a	DCP17053	
CLK 220 CDI	OM 612.962; OM 612.967		10/02-05/09	7SEU17C	R134a	DCP17040	A0012301411
CLK 220 CDI	OM 612.962; OM 612.967	All Climate zones	10/02-05/09	7SEU17C	R134a	DCP17119	
CLK 220 CDI	OM 612.967		10/02-05/05	7SEU17C	R134a	DCP17026	A0002305111
CLK 220 CDI	OM 612.967		10/02-05/05	7SEU17C	R134a	DCP17053	A0012305611
CLK 220 CDI	OM 642.910		01/05-05/09	6SEU16C	R134a	DCP17086	A0012307911
CLK 220 CDI	OM 642.910		06/05-05/09	6SEU16C	R134a	DCP17067	A0012305711
CLK 220 CDI	OM 642.910		06/05-05/09	7SEU17C	R134a	DCP17102	A0012301311
CLK 220 CDI	OM 642.910	All Climate zones	01/05-05/09	7SEU17C	R134a	DCP17090	
CLK 240	M 112.912		06/02-05/05	7SEU17C	R134a	DCP17026	A0002305111
CLK 240	M 112.912		06/02-05/05	7SEU17C	R134a	DCP17043	A0012300011
CLK 240	M 112.912		06/02-03/10	7SEU17C	R134a	DCP17040	A0012301411
CLK 240	M 112.912	All Climate zones	06/02-03/10	7SEU17C	R134a	DCP17119	
CLK 280	M 272.940		01/05-06/09	7SEU17C	R134a	DCP17053	
CLK 320	M 112.955		06/02-05/05	7SEU17C	R134a	DCP17026	A0002305111
CLK 320	M 112.955		06/02-05/05	7SEU17C	R134a	DCP17043	A0012300011
CLK 320	M 112.955		06/02-03/10	7SEU17C	R134a	DCP17040	A0012301411
CLK 320	M 112.955	All Climate zones	06/02-03/10	7SEU17C	R134a	DCP17119	
CLK 320 CDI	OM 642.910		03/05-03/10	6SEU16C	R134a	DCP17086	A0012307911
CLK 320 CDI	OM 642.910		09/05-06/09	6SEU16C	R134a	DCP17067	A0012305711
CLK 320 CDI	OM 642.910		09/05-06/09	7SEU17C	R134a	DCP17102	A0012301311
CLK 320 CDI	OM 642.910	All Climate zones	03/05-03/10	7SEU17C	R134a	DCP17090	
CLK 350	M 272.960		01/05-06/09	7SEU17C	R134a	DCP17053	
CLK 500	M 113.968		06/02-03/10	7SEU17C	R134a	DCP17160	
CLK 500	M 273.965;M 273.967		06/06-03/10	7SEU17C	R134a	DCP17119	
CLK AMG DTM	M 113.994		06/04-10/05	7SEU17C	R134a	DCP17119	
CLK AMG DTM	M 113.994		05/05-10/05	7SEU17C	R134a	DCP17038	
<b>CLS (218) (11-)</b>							
CLS 63 AMG	M 157.980;M 157.981		01/11-12/17	7SEU17C	R134a	DCP17142	
CLS 63 AMG	M 157.981		10/12-12/17	7SEU17C	R134a	DCP17038	
CLS 63 AMG	M 157.981		10/12-12/17	7SEU17C	R134a	DCP17108	A0012302611
CLS 63 AMG 4-matic	M 157.981		02/13-12/17	7SEU17C	R134a	DCP17038	
CLS 63 AMG 4-matic	M 157.981		02/13-12/17	7SEU17C	R134a	DCP17108	A0012302611
CLS 220 BlueTEC / d	OM 651.924		05/14-12/17	6SBU16C	R134a	DCP17155	
CLS 220 BlueTEC / d	OM 651.924		05/14-12/17	6SBU16C	R134a	DCP17165	A0008302500

				TYPE	GAS	DENSO PN	OE
<b>MERCEDES-BENZ</b> <i>Continued</i>							
<b>CLS (218) (11-)</b> <i>Continued</i>							
CLS 250 BlueTEC / d 4-matic	OM 651.924			05/14-12/17	6SBU16C	R134a	DCP17155
CLS 250 BlueTEC / d 4-matic	OM 651.924			05/14-12/17	6SBU16C	R134a	DCP17165
CLS 250 CDI / BlueTEC / d	OM 651.924			04/11-12/17	6SBU16C	R134a	DCP17148
CLS 250 CDI / BlueTEC / d	OM 651.924			04/11-12/17	6SBU16C	R134a	DCP17165
CLS 250 CDI / BlueTEC / d	OM 651.924			01/12-12/17	6SBU16C	R134a	DCP17155
CLS 350	M 276.952			01/11-08/14	6SBU16C	R134a	DCP17155
CLS 350	M 276.952			01/11-08/14	6SBU16C	R134a	DCP17169
CLS 350 BlueTEC / d	OM 642.852;OM 642.853			02/13-12/17	6SBU16C	R134a	DCP17178
CLS 350 BlueTEC / d 4-matic	OM 642.854;OM 642.858			02/13-12/17	6SBU16C	R134a	DCP17178
CLS 350 CDI / d	OM 642.852;OM 642.853			01/11-08/14	6SEU16C	R134a	DCP17104
CLS 350 CDI / d	OM 642.852;OM 642.853			01/11-08/14	6SBU16C	R134a	DCP17178
CLS 350 CDI / d 4-matic	OM 642.853;OM 642.854;OM 642.858			09/11-08/14	6SBU16C	R134a	DCP17178
CLS 350 d 4-matic	OM 642.854;OM 642.858			04/15-12/17	6SBU16C	R134a	DCP17178
CLS 400	M 276.820			05/14-12/17	6SBU16C	R134a	DCP17155
CLS 400	M 276.820			05/14-12/17	6SBU16C	R134a	DCP17165
CLS 400	M 276.850			07/14-12/17	6SBU16C	R134a	DCP17155
CLS 400	M 276.850			07/14-12/17	6SBU16C	R134a	DCP17165
CLS 400 4-matic	M 276.820			05/14-12/17	6SBU16C	R134a	DCP17155
CLS 400 4-matic	M 276.820			05/14-12/17	6SBU16C	R134a	DCP17165
CLS 400 4-matic	M 276.850			07/14-12/17	6SBU16C	R134a	DCP17155
CLS 400 4-matic	M 276.850			07/14-12/17	6SBU16C	R134a	DCP17165
CLS 500	M 278.922			07/14-12/17	6SEU16C	R134a	DCP17161
CLS 500 4-matic	M 278.922			07/14-12/17	6SEU16C	R134a	DCP17161
<b>CLS (C219) (04-10)</b>							
CLS 55 AMG	M 113.990			01/05-01/08	7SEU17C	R134a	DCP17026
CLS 55 AMG	M 113.990			01/05-01/08	7SEU17C	R134a	DCP17039
CLS 55 AMG	M 113.990			01/05-01/08	6SEU16C	R134a	DCP17068
CLS 55 AMG	M 113.990			01/05-12/10	7SEU17C	R134a	DCP17040
CLS 55 AMG	M 113.990	All Climate zones		01/05-12/10	7SEU17C	R134a	DCP17119
CLS 63 AMG	M 156.983			04/06-01/08	7SEU17C	R134a	DCP17142
CLS 280	M 272.943			07/08-12/10	6SEU16C	R134a	DCP17107
CLS 320 CDI	OM 642.920			01/05-12/10	6SEU16C	R134a	DCP17086
CLS 320 CDI	OM 642.920			06/05-01/08	6SEU16C	R134a	DCP17067
CLS 320 CDI	OM 642.920			06/05-01/08	7SEU17C	R134a	DCP17102
CLS 320 CDI	OM 642.920	All Climate zones		01/05-12/10	7SEU17C	R134a	DCP17090
CLS 350	M 272.964;M 272.985			10/04-01/08	7SEU17C	R134a	DCP17026
CLS 350	M 272.964;M 272.985			10/04-01/08	6SEU16C	R134a	DCP17068
CLS 350	M 272.964;M 272.985			10/04-12/10	7SEU17C	R134a	DCP17040
CLS 350	M 272.964;M 272.985	All Climate zones		10/04-12/10	7SEU17C	R134a	DCP17119
CLS 350 CDI	OM 642.920			04/09-12/10	6SEU16C	R134a	DCP17067
CLS 500	M 113.967			10/04-01/08	7SEU17C	R134a	DCP17039
CLS 500	M 113.967			10/04-01/08	7SEU17C	R134a	DCP17130
CLS 500	M 273.960			04/06-12/10	7SEU17C	R134a	DCP17026
CLS 500	M 273.960			04/06-12/10	7SEU17C	R134a	DCP17040
CLS 500	M 273.960			04/06-12/10	6SEU16C	R134a	DCP17068
CLS 500	M 273.960			04/08-12/10	7SEU17C	R134a	DCP17130
CLS 500	M 273.960	All Climate zones		04/06-12/10	7SEU17C	R134a	DCP17119
<b>COUPE (C124) (87-93)</b>							
220 CE	M 111.960			10/92-05/93	10PA17C	R134a	DCP17011
230 CE	M 102.982			03/87-12/92	10P15C	R134a	DCP17001
230 CE	M 102.982			03/87-12/92	10PA17C	R134a	DCP17010
230 CE	M 102.982	Ch No: 141853;142394 >		03/87-12/92	10PA15C	R134a	DCP17012
230 CE Cat	M 102.982			06/89-12/92	10P15C	R134a	DCP17001
230 CE Cat	M 102.982	Ch No: 141853;142394 >		06/89-12/92	10PA15C	R134a	DCP17012
300 CE	M 103.983			03/87-05/93	10P15C	R134a	DCP17001
300 CE	M 103.983			03/87-05/93	10PA15C	R134a	DCP17012
300 CE	M 103.983	Ch No: 031824;181215 >		03/87-05/93	10PA17C	R134a	DCP17010
300 CE-24	M 104.980			09/89-12/92	10PA17C	R134a	DCP17010
320 CE	M 104.992			10/92-05/93	10PA17C	R134a	DCP17010
<b>E-CLASS (124) (92-96)</b>							
E 60 AMG	M 119.974 (AMG 6.0)	Ch No: 006123>		05/94-06/95	10PA17C	R134a	DCP17011





				TYPE	GAS	DENSO PN	OE
<b>MERCEDES-BENZ</b> <i>Continued</i>							
<b>E-CLASS (124) (92-96)</b> <i>Continued</i>							
E 200	M 111.940			06/93-06/95	10PA17C	R134a	DCP17011
E 200 D	OM 601.912			06/93-06/95	10PA15C	R134a	DCP17013
E 200 T	M 111.940			06/93-02/96	10PA17C	R134a	DCP17011
E 220	M 111.960			06/93-06/95	10PA17C	R134a	DCP17011
E 220 T	M 111.960			06/93-01/96	10PA17C	R134a	DCP17011
E 250 D	OM 605.911			07/93-06/95	10PA15C	R134a	DCP17012
E 250 TD	OM 605.911			06/93-02/96	10PA15C	R134a	DCP17012
E 250 Turbo-D	OM 602.962			06/93-02/96	10P15C	R134a	DCP17001
E 250 Turbo-D	OM 602.962	Ch No: 000413;003245 >		06/93-02/96	10PA15C	R134a	DCP17012
E 280	M 104.942			06/93-06/95	10PA17C	R134a	DCP17010
E 280 T	M 104.942			06/93-01/96	10PA17C	R134a	DCP17010
E 300 4-matic	M 103.985			06/93-06/95	10P15C	R134a	DCP17001
E 300 4-matic	M 103.985	Ch No: 002138;008114 >		06/93-06/95	10PA17C	R134a	DCP17010
E 300 D	OM 606.910			07/93-06/95	10PA15C	R134a	DCP17013
E 300 D	OM 606.910	Ch No: 70268>		07/93-06/95	10PA15C	R134a	DCP17012
E 300 T 4-matic	M 103.985			06/93-02/96	10P15C	R134a	DCP17001
E 300 T 4-matic	M 103.985	Ch No: 002138;008114 >		06/93-02/96	10PA17C	R134a	DCP17010
E 300 T Turbo-D	OM 603.960			06/93-02/96	10P15C	R134a	DCP17001
E 300 T Turbo-D	OM 603.960	Ch No: 023876>		06/93-02/96	10PA15C	R134a	DCP17012
E 300 T Turbo-D 4-matic	OM 603.963			06/93-02/96	10P15C	R134a	DCP17001
E 300 T Turbo-D 4-matic	OM 603.963	Ch No: 001905>		06/93-02/96	10PA15C	R134a	DCP17012
E 300 TD	OM 606.910			06/93-02/96	10PA15C	R134a	DCP17012
E 300 Turbo-D	OM 603.960			06/93-06/95	10P15C	R134a	DCP17001
E 300 Turbo-D	OM 603.960	Ch No: 023876>		06/93-06/95	10PA15C	R134a	DCP17012
E 300 Turbo-D 4-matic	OM 603.963			06/93-06/95	10P15C	R134a	DCP17001
E 300 Turbo-D 4-matic	OM 603.963	Ch No: 001905>		06/93-06/95	10PA15C	R134a	DCP17012
E 320	M 104.992			06/93-06/95	10PA17C	R134a	DCP17010
E 320 T	M 104.992			06/93-02/96	10PA17C	R134a	DCP17010
E 420	M 119.975			06/93-06/95	10PA17C	R134a	DCP17011
E 500	M 119.974	Ch No: 006123>		06/93-06/95	10PA17C	R134a	DCP17011
<b>E-CLASS (210) (95-03)</b>							
E 50 AMG	M 119.985 (AMG 5.0)	Ch No: 010821>		02/96-08/97	7SBU16C	R134a	DCP17023
E 55 AMG	M 113.980			08/97-03/02	7SBU16C	R134a	DCP17023
E 200	M 111.942			06/95-08/00	7SBU16C	R134a	DCP17023
E 200 CDI	OM 611.961			07/99-03/02	7SBU16C	R134a	DCP17023
E 200 CDI	OM 611.961			06/98-03/02	7SBU16C	R134a	DCP17023
E 200 D	OM 604.917			01/96-06/99	7SBU16C	R134a	DCP17023
E 200 Kompressor	M 111.947;M 111.957			06/97-03/03	7SBU16C	R134a	DCP17023
E 220 CDI	OM 611.961			07/99-03/03	7SBU16C	R134a	DCP17023
E 220 CDI	OM 611.961			06/98-07/99	7SBU16C	R134a	DCP17023
E 220 D	OM 604.912			06/95-07/99	7SBU16C	R134a	DCP17023
E 230	M 111.970			06/95-06/97	7SBU16C	R134a	DCP17023
E 240	M 112.911			06/97-03/03	7SBU16C	R134a	DCP17023
E 240	M 112.914			08/00-03/03	7SBU16C	R134a	DCP17023
E 250 D	OM 605.912			06/95-07/99	7SBU16C	R134a	DCP17023
E 250 Turbo-D	OM 605.962			06/97-07/99	7SBU16C	R134a	DCP17023
E 270 CDI	OM 612.961			07/99-03/03	7SBU16C	R134a	DCP17023
E 280	M 104.945;M 112.921			01/96-03/03	7SBU16C	R134a	DCP17023
E 280 4-matic	M 112.921			12/96-06/99	7SBU16C	R134a	DCP17023
E 290 Turbo-D	OM 602.982			03/96-07/99	7SBU16C	R134a	DCP17023
E 300 D	OM 606.912			06/95-06/97	7SBU16C	R134a	DCP17023
E 300 Turbo-D	OM 606.962			12/96-07/99	7SBU16C	R134a	DCP17023
E 320	M 104.995;M 112.941			06/95-03/03	7SBU16C	R134a	DCP17023
E 320 4-matic	M 112.941			12/96-06/99	7SBU16C	R134a	DCP17023
E 320 CDI	OM 613.961			07/99-03/02	7SBU16C	R134a	DCP17023
E 320 CDI	OM 613.961			07/99-03/03	7SBU16C	R134a	DCP17023
E 420	M 119.985			01/96-06/97	7SBU16C	R134a	DCP17023
E 430	M 113.940			06/97-03/03	7SBU16C	R134a	DCP17023
E 430 4-matic	M 113.940			05/99-03/03	7SBU16C	R134a	DCP17023
<b>E-CLASS (211) (02-09)</b>							
E 55 AMG Kompressor	M 113.990			10/02-03/06	7SEU17C	R134a	DCP17026





				TYPE	GAS	DENSO PN	OE	
<b>MERCEDES-BENZ</b> <i>Continued</i>								
<b>E-CLASS (211) (02-09)</b> <i>Continued</i>								
E 55 AMG Kompressor	M 113.990			10/02-07/06	6SEU16C	R134a	DCP17068	A0012308111
E 55 AMG Kompressor	M 113.990			10/02-12/08	7SEU17C	R134a	DCP17040	A0012301411
E 55 AMG Kompressor	M 113.990	All Climate zones		10/02-12/08	7SEU17C	R134a	DCP17119	
E 63 AMG	M 156.983			03/06-07/09	7SEU17C	R134a	DCP17142	
E 200 CDI	OM 646.820;OM 646.821			07/07-07/09	6SEU16C	R134a	DCP17105	A0022305111
E 200 CDI	OM 646.820;OM 646.821;OM 646.951			07/02-07/07	7SEU17C	R134a	DCP17026	A0012301111
E 200 CDI	OM 646.820;OM 646.821;OM 646.951			07/02-07/07	6SEU16C	R134a	DCP17068	
E 200 CDI	OM 646.820;OM 646.821;OM 646.951			07/02-07/09	7SEU17C	R134a	DCP17040	A0012301411
E 200 CDI	OM 646.820;OM 646.821;OM 646.951	All Climate zones		07/02-07/09	7SEU17C	R134a	DCP17119	
E 200 Kompressor	M 271.941;M 271.956			11/02-11/06	7SEU17C	R134a	DCP17038	
E 200 Kompressor	M 271.941;M 271.956			11/02-07/09	7SEU17C	R134a	DCP17108	A0012302611
E 200 Kompressor	M 271.956			12/06-07/09	6SEU16C	R134a	DCP17103	A0012308011
E 200 NGT	M 271.941			03/04-12/08	7SEU17C	R134a	DCP17108	A0012302611
E 200 NGT	M 271.941			04/06-11/06	7SEU17C	R134a	DCP17038	A0012302611
E 200 NGT	M 271.941			12/06-12/08	6SEU16C	R134a	DCP17103	A0012308011
E 220 CDI	OM 646.821			04/06-07/09	7SEU17C	R134a	DCP17026	A0012301111
E 220 CDI	OM 646.821			04/06-07/09	7SEU17C	R134a	DCP17040	A0012301411
E 220 CDI	OM 646.821			07/07-12/08	6SEU16C	R134a	DCP17105	A0022305111
E 220 CDI	OM 646.821	All Climate zones		04/06-07/09	7SEU17C	R134a	DCP17119	
E 220 CDI	OM 646.821;OM 646.961			03/02-07/09	6SEU16C	R134a	DCP17068	
E 230	M 272.922			05/07-07/09	6SEU16C	R134a	DCP17107	
E 240	M 112.913			03/02-05/05	7SEU17C	R134a	DCP17026	A0012301111
E 240	M 112.913			03/02-05/05	7SEU17C	R134a	DCP17039	A0012301211
E 240	M 112.913			03/02-05/05	6SEU16C	R134a	DCP17068	A0012308111
E 240	M 112.913; M 112.917			03/02-12/08	7SEU17C	R134a	DCP17040	A0012301411
E 240	M 112.913; M 112.917	All Climate zones		03/02-12/08	7SEU17C	R134a	DCP17119	
E 240 4-matic	M 112.917			03/03-06/05	7SEU17C	R134a	DCP17039	
E 270 CDI	OM 647.961			03/02-07/05	7SEU17C	R134a	DCP17026	A0012301111
E 270 CDI	OM 647.961			03/02-07/05	6SEU16C	R134a	DCP17068	A0012308111
E 270 CDI	OM 647.961			03/02-07/09	7SEU17C	R134a	DCP17040	A0012301411
E 270 CDI	OM 647.961	All Climate zones		03/02-07/09	7SEU17C	R134a	DCP17119	
E 280	M 272.943			04/06-07/09	6SEU16C	R134a	DCP17107	
E 280 4-matic	M 272.943;M 272.944			01/06-07/09	6SEU16C	R134a	DCP17107	
E 280 CDI	OM 642.920			03/05-07/09	6SEU16C	R134a	DCP17086	A0012307911
E 280 CDI	OM 642.920			04/06-07/09	6SEU16C	R134a	DCP17067	A0012308611
E 280 CDI	OM 642.920			04/06-07/09	7SEU17C	R134a	DCP17102	A0012301311
E 280 CDI	OM 642.920	All Climate zones		03/05-07/09	7SEU17C	R134a	DCP17090	
E 280 CDI	OM 648.961			05/04-07/05	7SEU17C	R134a	DCP17026	A0012301111
E 280 CDI	OM 648.961			05/04-07/05	6SEU16C	R134a	DCP17067	A0012305711
E 280 CDI	OM 648.961			05/04-07/05	6SEU16C	R134a	DCP17068	A0012308111
E 280 CDI	OM 648.961			05/04-07/05	7SEU17C	R134a	DCP17102	A0012301311
E 280 CDI	OM 648.961			05/04-12/08	6SEU16C	R134a	DCP17086	A0012307911
E 280 CDI	OM 648.961			05/04-07/09	7SEU17C	R134a	DCP17040	A0012301411
E 280 CDI	OM 648.961	All Climate zones		05/04-12/08	7SEU17C	R134a	DCP17090	
E 280 CDI	OM 648.961	All Climate zones		05/04-07/09	7SEU17C	R134a	DCP17119	
E 280 CDI 4-matic	OM 642.921			03/05-07/09	6SEU16C	R134a	DCP17086	A0012307911
E 280 CDI 4-matic	OM 642.921			04/06-07/09	6SEU16C	R134a	DCP17067	A0012308611
E 280 CDI 4-matic	OM 642.921			04/06-07/09	7SEU17C	R134a	DCP17102	A0012301311
E 280 CDI 4-matic	OM 642.921	All Climate zones		03/05-07/09	7SEU17C	R134a	DCP17090	
E 300 BlueTEC	OM 642.920			09/07-12/08	6SEU16C	R134a	DCP17067	A0012308611
E 300 BlueTEC	OM 642.920			09/07-12/08	6SEU16C	R134a	DCP17086	A0012307911
E 300 BlueTEC	OM 642.920			09/07-12/08	7SEU17C	R134a	DCP17102	A0012301311
E 300 BlueTEC	OM 642.920	All Climate zones		09/07-12/08	7SEU17C	R134a	DCP17090	
E 320	M 112.949			03/02-03/06	7SEU17C	R134a	DCP17039	A0012301211
E 320	M 112.949			03/02-03/06	6SEU16C	R134a	DCP17068	A0012308111
E 320 4-matic	M 112.954			03/03-03/06	7SEU17C	R134a	DCP17039	
E 320 CDI	OM 642.920			03/05-07/09	6SEU16C	R134a	DCP17086	A0012307911
E 320 CDI	OM 642.920			04/06-07/09	6SEU16C	R134a	DCP17067	A0012308611
E 320 CDI	OM 642.920			04/06-07/09	7SEU17C	R134a	DCP17102	A0012301311
E 320 CDI	OM 642.920	All Climate zones		03/05-07/09	7SEU17C	R134a	DCP17090	
E 320 CDI	OM 648.961			11/02-07/06	7SEU17C	R134a	DCP17026	A0012301111





				TYPE	GAS	DENSO PN	OE
<b>MERCEDES-BENZ</b> <i>Continued</i>							
<b>E-CLASS (211) (02-09)</b> <i>Continued</i>							
E 320 CDI	OM 648.961		11/02-07/06	6SEU16C	R134a	DCP17068	A0012308111
E 320 CDI	OM 648.961		11/02-07/09	7SEU17C	R134a	DCP17040	A0012301411
E 320 CDI	OM 648.961	All Climate zones	11/02-07/09	7SEU17C	R134a	DCP17119	
E 320 CDI 4-matic	OM 642.910;OM 642.921		03/05-07/09	6SEU16C	R134a	DCP17086	A0012307911
E 320 CDI 4-matic	OM 642.910;OM 642.921		04/06-07/09	6SEU16C	R134a	DCP17067	A0012308611
E 320 CDI 4-matic	OM 642.910;OM 642.921		04/06-07/09	7SEU17C	R134a	DCP17102	A0012301311
E 320 CDI 4-matic	OM 642.910;OM 642.921	All Climate zones	03/05-07/09	7SEU17C	R134a	DCP17090	
E 350	M 272.964		04/06-07/09	6SEU16C	R134a	DCP17107	
E 350 4-matic	M 272.972		04/06-07/09	6SEU16C	R134a	DCP17107	
E 350 CGI	M 272.985		05/06-07/09	6SEU16C	R134a	DCP17068	
E 350 CGI	M 272.985		09/07-12/08	6SEU16C	R134a	DCP17107	
E 400 CDI	OM 628.961		02/03-07/05	7SEU17C	R134a	DCP17102	
E 400 CDI	OM 628.961	All Climate zones	02/03-12/08	7SEU17C	R134a	DCP17090	
E 420 CDI	OM 629.910		01/06-12/08	7SEU17C	R134a	DCP17146	
E 500	M 113.967		03/02-03/06	7SEU17C	R134a	DCP17026	A0012301111
E 500	M 113.967		03/02-03/06	7SEU17C	R134a	DCP17039	A0012301211
E 500	M 113.967		03/02-03/06	6SEU16C	R134a	DCP17068	A0012308111
E 500	M 113.967		03/02-12/08	7SEU17C	R134a	DCP17040	A0012301411
E 500	M 113.967		04/06-07/09	7SEU17C	R134a	DCP17130	A0022306611
E 500	M 113.967	All Climate zones	03/02-12/08	7SEU17C	R134a	DCP17119	
E 500	M 273.960		04/06-07/09	7SEU17C	R134a	DCP17026	A0012301111
E 500	M 273.960		04/06-07/09	7SEU17C	R134a	DCP17040	A0012301411
E 500	M 273.960		04/06-07/09	6SEU16C	R134a	DCP17068	A0012308111
E 500	M 273.960	All Climate zones	04/06-07/09	7SEU17C	R134a	DCP17119	
E 500 4-matic	M 113.969		10/03-03/06	7SEU17C	R134a	DCP17039	A0012301211
E 500 4-matic	M 113.969		04/06-07/09	7SEU17C	R134a	DCP17130	A0022306611
E 500 4-matic	M 273.962		04/06-07/09	7SEU17C	R134a	DCP17026	A0012301111
E 500 4-matic	M 273.962		04/06-07/09	7SEU17C	R134a	DCP17040	A0012301411
E 500 4-matic	M 273.962		04/06-07/09	6SEU16C	R134a	DCP17068	A0012308111
E 500 4-matic	M 273.962	All Climate zones	04/06-07/09	7SEU17C	R134a	DCP17119	
<b>E-CLASS (212) (09-)</b>							
E 63 AMG	M 157.980; M 157.981		02/11-12/16	6SEU16C	R134a	DCP17161	
E 63 AMG	M 157.981		02/11-12/16	7SEU17C	R134a	DCP17038	
E 63 AMG	M 157.981		02/11-12/16	7SEU17C	R134a	DCP17108	A0012302611
E 63 AMG	M 156.985		08/09-12/15	6SBU16C	R134a	DCP17165	
E 63 AMG 4-matic	M 157.981		02/11-12/16	7SEU17C	R134a	DCP17038	
E 63 AMG 4-matic	M 157.981		02/11-12/16	7SEU17C	R134a	DCP17108	A0012302611
E 200	M 274.920		11/12-12/16	6SBU16C	R134a	DCP17155	
E 200	M 274.920		11/12-12/16	6SBU16C	R134a	DCP17165	A0008302500
E 200 CDI / BlueTEC	OM 651.925		01/09-12/16	6SBU16C	R134a	DCP17179	A0008302700
E 200 CDI / BlueTEC	OM 651.925		09/09-12/16	6SBU16C	R134a	DCP17157	22309211
E 200 CDI / BlueTEC	OM 651.925		09/09-12/16	6SBU16C	R134a	DCP17165	22303111; 8302500
E 200 CDI / BlueTEC	OM 651.925		11/09-12/16	6SBU16C	R134a	DCP17148	32302911
E 200 CGI	M 271.820;M 271.860		03/11-12/16	6SBU16C	R134a	DCP17140	32308511
E 200 CGI	M 271.860		11/09-12/16	6SEU16C	R134a	DCP17112	32304811
E 200 NGT	M 271.958		03/11-12/15	6SEU16C	R134a	DCP17101	
E 200 NGT	M 274.920		07/13-12/15	6SBU16C	R134a	DCP17155	
E 200 NGT	M 274.920		07/13-12/15	6SBU16C	R134a	DCP17165	A0008302500
E 220 BlueTEC	OM 651.924		05/14-12/15	6SBU16C	R134a	DCP17155	
E 220 BlueTEC	OM 651.924		05/14-12/15	6SBU16C	R134a	DCP17179	A0008302700
E 220 BlueTEC 4-matic	OM 651.924		12/14-12/16	6SBU16C	R134a	DCP17165	A0008302500
E 220 BlueTEC 4-matic	OM 651.924		12/14-12/16	6SBU16C	R134a	DCP17179	A0008302700
E 220 BlueTEC 4-matic	OM 651.924		01/15-12/15	6SBU16C	R134a	DCP17155	
E 220 CDI	OM 651.924		08/09-08/14	6SBU16C	R134a	DCP17154	
E 220 CDI	OM 651.924		08/09-08/14	6SBU16C	R134a	DCP17179	A0008302700
E 220 CDI	OM 651.924		09/09-12/15	6SBU16C	R134a	DCP17165	
E 220 CDI / BlueTEC	OM 651.924		01/09-12/16	6SBU16C	R134a	DCP17165	
E 220 CDI / BlueTEC	OM 651.924		01/09-12/16	6SBU16C	R134a	DCP17179	A0008302700
E 250	M 274.920		11/12-12/16	6SBU16C	R134a	DCP17155	
E 250	M 274.920		11/12-12/16	6SBU16C	R134a	DCP17165	A0008302500
E 250 CDI / BlueTEC	OM 651.924		01/09-02/13	6SBU16C	R134a	DCP17157	
E 250 CDI / BlueTEC	OM 651.924		01/09-12/16	6SBU16C	R134a	DCP17165	
E 250 CDI / BlueTEC	OM 651.924		01/09-12/16	6SBU16C	R134a	DCP17179	A0008302700





				TYPE	GAS	DENSO PN	OE
<b>MERCEDES-BENZ</b> <i>Continued</i>							
<b>E-CLASS (212) (09-)</b> <i>Continued</i>							
E 250 CDI / BlueTEC	OM 651.924		03/13-12/16	6SBU16C	R134a	DCP17148	
E 250 CDI / BlueTEC 4-matic	OM 651.924		07/10-12/16	6SBU16C	R134a	DCP17165	
E 250 CDI / BlueTEC 4-matic	OM 651.924		07/10-12/16	6SBU16C	R134a	DCP17179	A0008302700
E 250 CDI / BlueTEC 4-matic	OM 651.924		01/11-12/15	6SBU16C	R134a	DCP17155	A0008302600
E 250 CDI / BlueTEC 4-matic	OM 651.924		03/13-12/15	6SBU16C	R134a	DCP17148	
E 250 CGI	M 271.860		01/09-12/15	6SEU16C	R134a	DCP17112	32304811
E 250 CGI	M 271.860		03/11-12/15	6SBU16C	R134a	DCP17140	32308511
E 300	M 272.952		01/09-12/13	6SEU16C	R134a	DCP17100	
E 300	M 276.952		07/11-12/16	6SBU16C	R134a	DCP17155	
E 300	M 276.952		07/11-12/16	6SBU16C	R134a	DCP17165	A0008302500
E 300	M 276.952		07/11-12/16	6SBU16C	R134a	DCP17169	A0008302200
E 300	M 276.952		07/11-12/16	6SBU16C	R134a	DCP17176	A0032302811
E 300 4-matic	M 276.952		07/11-12/16	6SBU16C	R134a	DCP17155	
E 300 4-matic	M 276.952		07/11-12/16	6SBU16C	R134a	DCP17165	A0008302500
E 300 4-matic	M 276.952		07/11-12/16	6SBU16C	R134a	DCP17169	A0008302200
E 300 4-matic	M 276.952		07/11-12/16	6SBU16C	R134a	DCP17176	A0032302811
E 300 CDI	OM 642.850		12/09-12/10	6SBU16C	R134a	DCP17178	A0032308811
E 300 CDI / BlueTEC	OM 642.850;OM 642.852		11/09-12/16	6SBU16C	R134a	DCP17178	A0032308811
E 350	M 272.980;M 276.952		01/09-12/14	6SBU16C	R134a	DCP17165	
E 350	M 276.952		09/11-12/15	6SBU16C	R134a	DCP17155	
E 350	M 276.952		09/11-12/15	6SBU16C	R134a	DCP17169	A0008302200
E 350	M 276.952		09/11-12/15	6SBU16C	R134a	DCP17176	A0032302811
E 350 4-matic	M 272.977		01/09-12/11	6SBU16C	R134a	DCP17165	
E 350 4-matic	M 276.952		09/11-12/16	6SBU16C	R134a	DCP17155	
E 350 4-matic	M 276.952		09/11-12/16	6SBU16C	R134a	DCP17169	A0008302200
E 350 4-matic	M 276.952		09/11-12/16	6SBU16C	R134a	DCP17176	A0032302811
E 350 BlueTEC	OM 642.850;OM 642.852		01/09-12/16	6SBU16C	R134a	DCP17178	A0032308811
E 350 BlueTEC	OM 642.850;OM 642.852		09/09-12/16	6SEU16C	R134a	DCP17104	
E 350 BlueTEC 4-matic	OM 642.852;OM 642.858		01/13-12/16	6SBU16C	R134a	DCP17178	A0032308811
E 350 BlueTEC 4-matic	OM 642.858		11/12-12/16	6SEU16C	R134a	DCP17104	
E 350 CDI	OM 642.850		01/09-12/15	6SEU16C	R134a	DCP17104	
E 350 CDI	OM 642.850;OM 642.852		01/09-12/15	6SBU16C	R134a	DCP17178	A0032308811
E 350 CDI 4-matic	OM 642.856		09/09-12/11	6SEU16C	R134a	DCP17104	
E 350 CDI 4-matic	OM 642.856;OM 642.858		09/09-12/15	6SBU16C	R134a	DCP17178	A0032308811
E 350 CGI	M 272.982;M 272.983		01/09-12/11	6SEU16C	R134a	DCP17159	A0022307311
E 350 CGI	M 272.982;M 272.983		01/09-12/11	6SBU16C	R134a	DCP17165	A0008302500
E 400	M 276.820		01/13-12/16	6SBU16C	R134a	DCP17155	
E 400	M 276.820		01/13-12/16	6SBU16C	R134a	DCP17165	A0008302500
E 400	M 276.820		01/13-12/16	6SBU16C	R134a	DCP17169	A0008302200
E 400	M 276.850		07/14-12/16	6SBU16C	R134a	DCP17155	
E 400	M 276.850		07/14-12/16	6SBU16C	R134a	DCP17165	A0008302500
E 400 4-matic	M 276.820		01/13-12/16	6SBU16C	R134a	DCP17155	
E 400 4-matic	M 276.820		01/13-12/16	6SBU16C	R134a	DCP17165	A0008302500
E 400 4-matic	M 276.820		01/13-12/16	6SBU16C	R134a	DCP17169	A0008302200
E 400 4-matic	M 276.850		07/14-12/15	6SBU16C	R134a	DCP17165	A0008302500
E 400 4-matic	M 276.850		07/14-12/16	6SBU16C	R134a	DCP17155	
E 500	M 278.922		09/11-12/16	6SEU16C	R134a	DCP17161	
E 500	M 273.971		01/09-12/11	6SEU16C	R134a	DCP17120	
E 500 4-matic	M 278.922		09/11-12/16	6SEU16C	R134a	DCP17161	
E 500 4-matic	M 273.970		09/09-12/11	6SEU16C	R134a	DCP17120	
<b>E-CLASS Coupe / Convertible (124) (93-98)</b>							
E 36 AMG	M 104.992 (AMG 3.6)		05/94-03/98	10PA17C	R134a	DCP17010	
E 200	M 111.940		06/93-03/98	10PA17C	R134a	DCP17011	
E 220	M 111.960		06/93-03/98	10PA17C	R134a	DCP17011	
E 320	M 104.992		06/93-03/98	10PA17C	R134a	DCP17010	
<b>E-CLASS Coupe / Convertible (207) (09-)</b>							
E 200	M 274.920		03/13-12/16	6SBU16C	R134a	DCP17155	
E 200	M 274.920		03/13-12/16	6SBU16C	R134a	DCP17165	A0008302500
E 200 CGI	M 271.820; M 271.860		01/10-12/16	6SEU16C	R134a	DCP17112	A0032304811
E 200 CGI	M 271.820;M 271.860		01/10-12/16	6SBU16C	R134a	DCP17140	
E 220 BlueTEC	OM 651.911		05/14-12/16	6SBU16C	R134a	DCP17155	8302600
E 220 CDI	OM 651.911		02/10-12/16	6SBU16C	R134a	DCP17155	
E 220 CDI	OM 651.911		02/10-12/16	6SBU16C	R134a	DCP17179	A0008302700
E 220 CDI / BlueTEC / d	OM 651.911		01/10-12/16	6SBU16C	R134a	DCP17155	
E 220 CDI / BlueTEC / d	OM 651.911		01/10-12/16	6SBU16C	R134a	DCP17179	A0008302700
E 250	M 274.920		06/13-12/16	6SBU16C	R134a	DCP17155	
E 250	M 274.920		06/13-12/16	6SBU16C	R134a	DCP17165	A0008302500











				TYPE	GAS	DENSO PN	OE	
<b>MERCEDES-BENZ</b> <i>Continued</i>								
<b>E-CLASS Coupe / Convertible (207) (09-)</b> <i>Continued</i>								
E 250 CDI / BlueTEC / d	OM 651.911			01/09-12/16	6SBU16C	R134a	DCP17179	A0008302700
E 250 CDI / BlueTEC / d	OM 651.911			01/10-12/16	6SBU16C	R134a	DCP17155	
E 250 CGI	M 271.860			01/09-12/16	6SEU16C	R134a	DCP17112	A0032304811
E 250 CGI	M 271.860			01/09-12/16	6SBU16C	R134a	DCP17140	A0032308511
E 300	M 276.957			04/11-12/16	6SBU16C	R134a	DCP17155	
E 300	M 276.957			04/11-12/16	6SBU16C	R134a	DCP17165	
E 300	M 276.957			04/11-12/16	6SBU16C	R134a	DCP17177	A0008302300
E 320	M 276.820			07/14-12/16	6SBU16C	R134a	DCP17155	
E 320	M 276.820			07/14-12/16	6SBU16C	R134a	DCP17165	A0008302500
E 350	M 276.957			04/11-12/14	6SBU16C	R134a	DCP17155	
E 350	M 276.957			04/11-12/14	6SBU16C	R134a	DCP17165	
E 350	M 276.957			04/11-12/14	6SBU16C	R134a	DCP17177	A0008302300
E 350 4-matic	M 276.957			02/13-12/16	6SBU16C	R134a	DCP17155	
E 350 4-matic	M 276.957			02/13-12/16	6SBU16C	R134a	DCP17165	A0008302500
E 350 4-matic	M 276.957			02/13-12/16	6SBU16C	R134a	DCP17177	A0008302300
E 350 BlueTEC	OM 642.838			06/13-12/16	6SBU16C	R134a	DCP17178	A0032308811
E 350 BlueTEC	OM 642.838			06/13-12/16	6SEU16C	R134a	DCP17182	
E 350 BlueTEC / d	OM 642.838			05/14-12/16	6SBU16C	R134a	DCP17178	A0032308811
E 350 CDI	OM 642.836			01/09-12/11	6SBU16C	R134a	DCP17178	A0032308811
E 350 CDI	OM 642.836;OM 642.838			05/09-12/13	6SEU16C	R134a	DCP17104	
E 350 CGI	M 272.982;M 272.984			01/09-12/14	6SEU16C	R134a	DCP17100	
E 400	M 276.820			06/13-12/16	6SBU16C	R134a	DCP17155	
E 400	M 276.820			06/13-12/16	6SBU16C	R134a	DCP17165	A0008302500
E 400	M 276.850			07/14-12/16	6SBU16C	R134a	DCP17155	
E 400	M 276.850			07/14-12/16	6SBU16C	R134a	DCP17165	A0008302500
E 500	M 278.922			09/11-12/16	6SEU16C	R134a	DCP17182	
E 500	M 278.922			05/13-12/16	6SEU16C	R134a	DCP17161	
E 500	M 273.966			05/09-12/16	6SEU16C	R134a	DCP17120	
E 550	M 278.922			05/13-12/16	6SEU16C	R134a	DCP17161	
<b>G-CLASS (W460) (79-93)</b>								
230 G	M 115.973			02/80-07/87	10PA17C	R134a	DCP17010	
230 GE	M 102.987			05/87-08/92	10PA17C	R134a	DCP17010	
230 GE	M 102.981			04/82-08/92	10PA17C	R134a	DCP17010	
240 GD	OM 616.936			11/79-08/87	10P15C	R134a	DCP17001	
250 GD	OM 602.930			10/87-12/92	10P15C	R134a	DCP17002	
250 GD	OM 602.930			12/88-12/89	10P15C	R134a	DCP17001	
300 GD	OM 617.931			12/79-12/91	10P15C	R134a	DCP17002	
<b>G-CLASS (W461) (90-)</b>								
230 GE	M 102.979			09/89-07/96	10PA17C	R134a	DCP17010	
250 GD	OM 602.939			02/90-05/93	10PA15C	R134a	DCP17012	
290 GD/G 290 D	OM 602.942			06/93-07/00	10PA15C	R134a	DCP17012	
G 290 TD	OM 602.983			07/97-07/01	7SBU16C	R134a	DCP17023	
<b>G-CLASS (W463) (89-)</b>								
200 GE	M 102.965			01/90-07/93	10PA17C	R134a	DCP17010	
230 GE	M 102.989			06/90-06/93	10PA17C	R134a	DCP17010	
250 GD	OM 602.931			06/90-10/92	10P15C	R134a	DCP17002	
300 GD / G 300	OM 603.931			09/89-09/97	10PA15C	R134a	DCP17012	A1021310001
300 GD / G 300	OM 603.931			09/89-09/97	7SBU16C	R134a	DCP17023	
300 GE	M 103.987			06/90-09/97	10PA17C	R134a	DCP17010	
320 GE	M 104.996			09/94-11/97	10P17C	R134a	DCP17003	
320 GE	M 104.996			09/94-11/97	10PA17C	R134a	DCP17010	
350 G Turbo-D	OM 603.972			09/91-08/96	10PA15C	R134a	DCP17012	
350 Turbo GD	OM 603.972			09/91-08/96	10PA15C	R134a	DCP17012	
500 GE	M 117.965			09/93-12/94	10P17C	R134a	DCP17003	
G 270 CDI	OM 612.965			10/01-	7SEU17C	R134a	DCP17064	
G 300 TD	OM 606.964			08/96-07/00	7SBU16C	R134a	DCP17023	
G 320	M 104.996			09/94-12/97	10PA17C	R134a	DCP17010	
G 320	M 112.945			07/97-08/04	7SBU16C	R134a	DCP17023	
G 400 CDI	OM 628.962			12/00-	7SEU16C	R134a	DCP17144	
G 500	M 113.962			04/98-	7SBU16C	R134a	DCP17023	
<b>GL-CLASS (X164) (06-)</b>								
GL 320 CDI / 350 BlueTEC 4-matic	OM 642.820			12/09-08/12	7SEU17C	R134a	DCP17138	
GL 320 CDI 4-matic	OM 642.940			09/06-05/09	7SEU17C	R134a	DCP17062	
GL 320 CDI 4-matic	OM 642.940			09/06-05/09	7SEU17C	R134a	DCP17138	A0022305811
GL 350 CDI 4-matic	OM 642.822			10/10-08/12	7SEU17C	R134a	DCP17138	A0022305811
GL 420 CDI 4-matic	OM 629.912			09/06-05/09	7SEU17C	R134a	DCP17062	A0012304711
GL 420 CDI 4-matic	OM 629.912		For vehicles with front and rear A/C	09/06-05/09	7SEU17C	R134a	DCP17063	A0012307411





				TYPE	GAS	DENSO PN	OE
<b>MERCEDES-BENZ</b> <i>Continued</i>							
<b>GL-CLASS (X164) (06-)</b> <i>Continued</i>							
GL 450 4-matic	M 273.923		09/06-08/12	7SEU17C	R134a	DCP17058	
GL 450 CDI 4-matic	OM 629.912		05/09-08/12	7SEU17C	R134a	DCP17062	A0022305311
GL 500 4-matic	M 273.963		09/06-12/12	7SEU17C	R134a	DCP17058	A0012308411
<b>GL-CLASS (X166) (12-)</b>							
GL 350 CDI / BlueTec 4-matic	OM 642.826		07/12-10/15	6SBU16C	R134a	DCP17181	A0032306011
<b>GLE (W166) (15-)</b>							
250 d	OM 651.960		04/15-10/18	6SEU16C	R134a	DCP17162	
250 d 4-matic	OM 651.960		04/15-10/18	6SEU16C	R134a	DCP17162	
350 d 4-matic	OM 642.826		04/15-10/18	6SEU16C	R134a	DCP17163	
350 d 4-matic	OM 642.826		04/15-10/18	6SBU16C	R134a	DCP17181	A0032306011
<b>GLK (X204) (08-15)</b>							
200	M 274.920		08/13-06/15	6SBU16C	R134a	DCP17165	A0008302500
200 CDI	OM 651.913;OM 651.916		07/10-06/15	6SBU16C	R134a	DCP17148	
220 CDI	OM 651.916		12/08-06/15	6SBU16C	R134a	DCP17148	
220 CDI 4-matic	OM 651.912		12/08-06/15	6SBU16C	R134a	DCP17148	
250	M 274.920		08/13-06/15	6SBU16C	R134a	DCP17165	A0008302500
250 4-matic	M 274.920		08/13-06/15	6SBU16C	R134a	DCP17165	A0008302500
250 CDI 4-matic	OM 651.912		09/09-06/15	6SBU16C	R134a	DCP17148	
280 4-matic	M 272.948		06/08-06/09	6SEU16C	R134a	DCP17100	A0022303111
320 CDI 4-matic	OM 642.961		06/08-06/15	6SEU16C	R134a	DCP17104	
350	M 272.991		04/09-06/11	6SBU16C	R134a	DCP17165	
350 4-matic	M 272.971		06/08-04/11	6SEU16C	R134a	DCP17100	A0022303111
350 4-matic	M 276.957		06/08-06/15	6SEU16C	R134a	DCP17166	
350 4-matic	M 276.957		06/08-06/15	6SBU16C	R134a	DCP17169	A0008302200
350 CDI 4-matic	OM 642.832		07/09-06/15	6SEU16C	R134a	DCP17104	
350 CDI 4-matic	OM 642.835		07/12-06/15	6SBU16C	R134a	DCP17178	A0032308811
<b>GULLWING (W198) (54-57)</b>							
300 SL	M 198.980		09/54-05/57	10PA17C	R134a	DCP17010	
<b>KOMBI (S124) (85-93)</b>							
200 T	M 102.922		09/85-05/90	10P15C	R134a	DCP17001	A0002302411
200 T	M 102.922	Ch No: 031974;080746 >	01/86-05/90	10PA15C	R134a	DCP17012	A1021310001
200 T	M 102.922	Ch No: 80746>	09/85-08/89	10PA15C	R134a	DCP17012	A1021310001
200 T D	OM 601.912		03/86-08/91	10PA15C	R134a	DCP17013	
200 TE	M 102.962	Ch No: 32500>	09/88-12/89	10PA15C	R134a	DCP17012	A1021310001
200 TE	M 102.962;M 102.963		09/88-08/92	10P15C	R134a	DCP17001	A0002302411
200 TE	M 102.963	Ch No: 008412;032500 >	09/88-08/92	10PA15C	R134a	DCP17012	A1021310001
200 TE	M 111.940		05/86-06/93	10PA17C	R134a	DCP17011	
220 TE	M 111.960		10/92-05/93	10PA17C	R134a	DCP17011	
230 TE	M 102.982		03/86-08/92	10P15C	R134a	DCP17001	A0002302411
230 TE	M 102.982	Ch No: 141853;142394 >	03/86-08/92	10PA15C	R134a	DCP17012	A1021310001
230 TE	M 102.982	Ch No: 142394>	03/86-08/92	10PA15C	R134a	DCP17012	A1021310001
230 TE Cat	M 102.982		06/89-08/92	10P15C	R134a	DCP17001	A0002302411
230 TE Cat	M 102.982	Ch No: 141853;142394 >	06/89-08/92	10PA15C	R134a	DCP17012	A1021310001
250 T D	OM 602.912		03/86-06/93	10P15C	R134a	DCP17001	A0002302411
250 T D	OM 602.912	Ch No: 021758;148450 >	03/86-06/93	10PA15C	R134a	DCP17012	A1021310001
250 TD Turbo	OM 602.962		04/90-07/93	10P15C	R134a	DCP17001	A0002302411
250 TD Turbo	OM 602.962	Ch No: 000413;003245 >	04/90-07/93	10PA15C	R134a	DCP17012	A1021310001
260 TE FGST.	M 103.940		09/85-12/89	10PA17C	R134a	DCP17010	
280 TE	M 104.942		10/92-06/93	10PA17C	R134a	DCP17010	
300 T D	OM 603.912		09/86-06/93	10PA15C	R134a	DCP17013	A0002301211
300 T D	OM 603.912		01/89-06/93	10PA15C	R134a	DCP17012	
300 T D	OM 603.912	Ch No: 047342;070268 >	09/86-06/93	10PA15C	R134a	DCP17012	A1021310001
300 T D	OM 603.912	Ch No: 70268>	01/89-06/93	10PA15C	R134a	DCP17012	A1021310001
300 T Turbo-D	OM 603.960		01/89-06/93	10P15C	R134a	DCP17001	A0002302411
300 T Turbo-D	OM 603.960	Ch No: 023876>	01/89-06/93	10PA15C	R134a	DCP17012	A1021310001
300 T Turbo-D	OM 603.960; OM 603.963		09/86-01/89	10PA15C	R134a	DCP17013	
300 T Turbo-D 4-matic	OM 603.960		01/89-06/93	10P15C	R134a	DCP17001	A0002302411





				TYPE	GAS	DENSO PN	OE
<b>MERCEDES-BENZ</b> <i>Continued</i>							
<b>KOMBI (S124) (85-93)</b> <i>Continued</i>							
300 T Turbo-D 4-matic	OM 603.960	Ch No: 001905>	01/89-06/93	10PA15C	R134a	DCP17012	A1021310001
300 TE	M 103.983		01/86-08/92	10P15C	R134a	DCP17001	A0002302411
300 TE	M 103.983		01/86-08/92	10PA15C	R134a	DCP17012	A1021310001
300 TE	M 103.983	Ch No: 031824;181215 >	01/86-08/92	10PA17C	R134a	DCP17010	A0002300511
300 TE 4-matic	M 103.983		09/86-12/89	10P15C	R134a	DCP17001	A0002302411
300 TE 4-matic	M 103.983	Ch No: 002138;008114 >	09/86-12/89	10PA17C	R134a	DCP17010	A0002300511
300 TE 4-matic	M 103.985		09/89-06/93	10PA17C	R134a	DCP17010	
300 TE-24	M 104.980		09/89-08/92	10PA17C	R134a	DCP17010	
<b>M-CLASS (W163) (98-05)</b>							
ML 55 AMG	M 113.981		02/00-08/04	7SBU16C	R134a	DCP17023	
ML 230	M 111.977		02/98-06/05	7SBU16C	R134a	DCP17023	A0002306811
ML 230	M 111.977		02/98-06/05	7SBU16C	R134a	DCP17024	A0002306811
ML 270 CDI	OM 612.963		12/99-09/00	7SBU16C	R134a	DCP17024	A0002306811
ML 270 CDI	OM 612.963		09/00-06/05	7SEU17C	R134a	DCP17064	A0012302811
ML 320	M 112.942		02/98-08/02	7SBU16C	R134a	DCP17023	
ML 350	M 112.970		08/02-06/05	7SEU17C	R134a	DCP17064	
ML 400 CDI	OM 628.963		09/01-06/05	7SEU16C	R134a	DCP17144	
ML 430	M 113.942		02/98-05/01	7SBU16C	R134a	DCP17023	
ML 500	M 113.965		09/01-08/04	7SEU17C	R134a	DCP17063	A0012307411
ML 500	M 113.965		09/01-08/04	7SEU17C	R134a	DCP17064	A0012302811
<b>M-CLASS (W164) (05-11)</b>							
ML 63 AMG 4-matic	M 156.980	Ch No: >43780	01/06-09/06	7SEU17C	R134a	DCP17065	
ML 63 AMG 4-matic	M 156.980	Ch No: 43781>	09/06-12/11	7SEU17C	R134a	DCP17135	
ML 280 CDI 4-matic	OM 642.940		07/05-04/08	7SEU17C	R134a	DCP17062	
ML 300 CDI 4-matic	OM 642.820;OM 642.940		07/09-12/11	7SEU17C	R134a	DCP17138	
ML 320 CDI 4-matic	OM 642.940		07/05-04/08	7SEU17C	R134a	DCP17062	A0012304711
ML 320 CDI 4-matic	OM 642.940		04/08-07/09	7SEU17C	R134a	DCP17138	A0022305811
ML 350 4-matic	M 272.967		02/05-12/11	7SEU17C	R134a	DCP17058	
ML 350 CDI 4-matic	OM 642.820;OM 642.940		07/09-12/11	7SEU17C	R134a	DCP17138	
ML 420 CDI 4-matic	OM 629.912		02/06-04/08	7SEU17C	R134a	DCP17062	
ML 450 CDI 4-matic	OM 629.912		09/09-12/11	7SEU17C	R134a	DCP17062	
ML 500 4-matic	M 113.964		07/05-07/07	7SEU17C	R134a	DCP17055	A0012307311
ML 500 4-matic	M 113.964		07/05-07/07	7SEU17C	R134a	DCP17059	A0012302011
ML 500 4-matic	M 273.963		12/07-12/11	7SEU17C	R134a	DCP17055	A0012307311
ML 500 4-matic	M 273.963		12/07-12/11	7SEU17C	R134a	DCP17058	A0012302511
<b>M-CLASS (W166) (11-15)</b>							
ML 63 AMG 4-matic	M 157.982		11/11-02/15	6SEU16C	R134a	DCP17162	
ML 250 CDI / BlueTEC 4-matic	OM 651.960		06/11-12/15	7SEU17C	R134a	DCP17126	
ML 300 4-matic	M 276.955		08/12-02/15	6SEU16C	R134a	DCP17156	
ML 350 4-matic	M 276.955		06/11-12/15	7SEU17C	R134a	DCP17127	A0022307511
ML 350 4-matic	M 276.955		06/11-12/15	6SEU16C	R134a	DCP17156	A0008303100
ML 350 BlueTEC 4-matic	OM 642.826; OM 642.864		06/11-02/15	6SEU16C	R134a	DCP17163	
ML 350 BlueTEC 4-matic	OM 642.826; OM 642.864		06/11-02/15	6SBU16C	R134a	DCP17181	A0032306011
ML 500 4-matic	M 278.928		02/12-02/15	7SEU17C	R134a	DCP17126	
<b>R-CLASS (251) (06-)</b>							
R 63 AMG 4-matic	M 156.980		02/06-09/06	7SEU17C	R134a	DCP17065	
R 63 AMG 4-matic	M 156.980		09/06-12/10	7SEU17C	R134a	DCP17135	
R 280	M 272.945		01/07-12/14	7SEU17C	R134a	DCP17058	
R 280 CDI	OM 642.870; OM 642.950		05/06-12/12	7SEU17C	R134a	DCP17062	A0012304711
R 280 CDI	OM 642.870; OM 642.950		05/06-12/12	7SEU17C	R134a	DCP17063	A0012307411
R 280 CDI 4-matic	OM 642.950		05/06-12/12	7SEU17C	R134a	DCP17062	A0012304711
R 280 CDI 4-matic	OM 642.950		05/06-12/12	7SEU17C	R134a	DCP17063	A0012307411
R 300 CDI	OM 642.870; OM 642.872; OM 642.950		07/09-12/12	7SEU17C	R134a	DCP17138	
R 320 CDI 4-matic	OM 642.950		01/06-06/09	7SEU17C	R134a	DCP17062	A0012304711
R 320 CDI 4-matic	OM 642.950		01/06-06/09	7SEU17C	R134a	DCP17063	A0012307411
R 350	M 272.967		01/07-12/12	7SEU17C	R134a	DCP17058	
R 350 4-matic	M 272.967		08/05-12/12	7SEU17C	R134a	DCP17058	A0012302511
R 350 4-matic	M 272.967		08/05-12/12	7SEU17C	R134a	DCP17059	A0012302011
R 350 4-matic	M 272.967	For vehicles with front and rear air conditioning	08/05-12/12	7SEU17C	R134a	DCP17055	A0012307311
R 350 CDI 4-matic	OM 642.870;OM 642.872;OM 642.950		01/06-12/14	7SEU17C	R134a	DCP17138	
R 350 CDI 4-matic	OM 642.950		07/09-12/12	7SEU17C	R134a	DCP17063	
R 350 CGI 4-matic	M 276.958		05/10-12/14	7SEU17C	R134a	DCP17127	

				TYPE	GAS	DENSO PN	OE	
<b>MERCEDES-BENZ</b> <i>Continued</i>								
<b>R-CLASS (251) (06-)</b> <i>Continued</i>								
R 500 4-matic	M 113.960; M 113.971			08/05-04/08	7SEU17C	R134a	DCP17059	A0012302011
R 500 4-matic	M 113.960; M 113.971	For vehicles with front and rear air conditioning		08/05-04/08	7SEU17C	R134a	DCP17055	A0012307311
<b>Saloon (W124) (84-93)</b>								
200	M 102.922			12/85-10/92	10P15C	R134a	DCP17001	A0002302411
200	M 102.922	Ch No: 031974;080746 >		12/85-05/90	10PA15C	R134a	DCP17012	A1021310001
200	M 102.922	Ch No: 80746>		01/86-10/92	10PA15C	R134a	DCP17012	A1021310001
200 D	OM 601.912			12/84-06/93	10PA15C	R134a	DCP17013	
200 E	M 102.963			09/88-08/93	10P15C	R134a	DCP17001	A0002302411
200 E	M 102.963	Ch No: 008412;032500 >		09/88-08/93	10PA15C	R134a	DCP17012	A1021310001
200 E	M 111.940			10/92-06/93	10PA17C	R134a	DCP17011	
220 E	M 111.960			10/92-06/93	10PA17C	R134a	DCP17011	
230 E	M 102.982			12/84-03/92	10P15C	R134a	DCP17001	A0002302411
230 E	M 102.982			01/85-06/93	10PA17C	R134a	DCP17010	
230 E	M 102.982	Ch No: 142394>		12/84-03/92	10PA15C	R134a	DCP17012	A1021310001
230 E Cat	M 102.982			06/89-09/92	10P15C	R134a	DCP17001	A0002302411
230 E Cat	M 102.982	Ch No: 141853;142394 >		06/89-09/92	10PA15C	R134a	DCP17012	A1021310001
250 D	OM 602.912			04/85-06/93	10P15C	R134a	DCP17001	A0002302411
250 D	OM 602.912	Ch No: 021758;148450 >		04/85-06/93	10PA15C	R134a	DCP17012	A1021310001
250 Turbo-D	OM 602.962			09/88-06/93	10P15C	R134a	DCP17001	A0002302411
250 Turbo-D	OM 602.962	Ch No: 000413;003244 >		09/88-06/93	10PA15C	R134a	DCP17012	A1021310001
260 E	M 103.940			09/85-08/92	10P15C	R134a	DCP17001	A0002302411
260 E	M 103.940			09/85-08/92	10PA15C	R134a	DCP17012	A1021310001
260 E	M 103.940	Ch No: 026999;070156 >		09/85-08/92	10PA17C	R134a	DCP17010	A0002300511
260 E 4-matic	M 103.940	Ch No: 26999>		12/86-07/89	10PA17C	R134a	DCP17010	A0002300511
260 E 4-matic	M 103.940;M 103.943			09/86-08/92	10P15C	R134a	DCP17001	A0002302411
260 E 4-matic	M 103.943	Ch No: 000447;001071 >		09/86-08/92	10PA15C	R134a	DCP17012	A1021310001
280 E	M 104.942			10/92-06/93	10PA17C	R134a	DCP17010	
300 D	OM 603.912			12/84-06/93	10PA15C	R134a	DCP17013	A0002301211
300 D	OM 603.912			06/90-06/93	10PA15C	R134a	DCP17012	
300 D	OM 603.912	Ch No: 047342;070268 >		12/84-08/89	10PA15C	R134a	DCP17012	A1021310001
300 D 4-matic	OM 603.913			09/86-06/93	10PA15C	R134a	DCP17013	
300 D 4-matic	OM 603.913	Ch No: 70268>		08/89-06/93	10PA15C	R134a	DCP17012	A1021310001
300 E	M 103.980;M 103.983			01/85-08/92	10P15C	R134a	DCP17001	A0002302411
300 E	M 103.980;M 103.983			01/85-08/92	10PA15C	R134a	DCP17012	A1021310001
300 E	M 103.983	Ch No: 031824;181215 >		06/85-08/92	10PA17C	R134a	DCP17010	A0002300511
300 E 4-matic	M 103.983;M 103.985			09/86-09/92	10P15C	R134a	DCP17001	A0002302411
300 E 4-matic	M 103.983;M 103.985	Ch No: 002138;008114 >		09/86-09/92	10PA17C	R134a	DCP17010	A0002300511
300 E-24	M 104.980			07/89-08/92	10PA17C	R134a	DCP17010	
300 Turbo-D	OM 603.960			09/87-06/93	10P15C	R134a	DCP17001	A0002302411
300 Turbo-D	OM 603.960	Ch No: 023876>		09/87-06/93	10PA15C	R134a	DCP17012	A1021310001
300 Turbo-D 4-matic	OM 603.963			09/87-09/88	10P15C	R134a	DCP17001	A0002302411
300 Turbo-D 4-matic	OM 603.963			01/88-06/93	10PA17C	R134a	DCP17010	
300 Turbo-D 4-matic	OM 603.963	Ch No: 001905>		09/87-09/88	10PA15C	R134a	DCP17012	A1021310001
320 E	M 104.992			10/92-06/93	10PA17C	R134a	DCP17010	
400 E 4.2	M 119.975			10/92-06/93	10PA17C	R134a	DCP17011	
500 E	M 119.974	Ch No: 006123>		01/91-06/93	10PA17C	R134a	DCP17011	
<b>S-CLASS (W126) (79-91)</b>								
3.8	M 116.961			08/80-08/84	10P17C	R134a	DCP17003	
260 SE	M 103.941			09/85-06/91	10PA15C	R134a	DCP17012	A1021310001





				TYPE	GAS	DENSO PN	OE
<b>MERCEDES-BENZ</b> <i>Continued</i>							
<b>S-CLASS (W126) (79-91)</b> <i>Continued</i>							
260 SE	M 103.941	Ch No: 004337;014294 >	09/85-06/91	10PA17C	R134a	DCP17010	A0002300511
260 SE	M 103.941	With Leveling Valve	09/85-06/91	10P15C	R134a	DCP17001	A0002302411
300 SE, SEL	M 103.981		09/85-06/91	10PA15C	R134a	DCP17012	A1021310001
300 SE, SEL	M 103.981	Ch No: 007562;098027 >	09/85-06/91	10PA17C	R134a	DCP17010	A0002300511
300 SE, SEL	M 103.981	With Leveling Valve	09/85-06/91	10P15C	R134a	DCP17001	A0002302411
380 SE, SEL	M 116.961		09/80-10/81	10P17C	R134a	DCP17003	
380 SE, SEL	M 116.963		10/81-08/84	10P17C	R134a	DCP17003	
420 SE, SEL	M 116.965		10/85-08/89	10P17C	R134a	DCP17003	
500 SE, SEL	M 117.961;M 117.963;M 117.965		08/80-06/91	10P17C	R134a	DCP17003	
500 SE, SEL Cat	M 117.965		06/89-06/91	10P17C	R134a	DCP17003	
560 SE, SEL	M 117.968		10/85-06/91	10P17C	R134a	DCP17003	
<b>S-CLASS (W140) (91-98)</b>							
300 SE 2.8	M 104.944		01/93-06/93	7SBU16C	R134a	DCP17023	A0002302011
300 SE 2.8	M 104.944	Ch No: 001153;017174 >	01/93-06/93	10PA20C	R134a	DCP17005	A0002301711
300 SE 2.8	M 104.944	Ch No: 001153;017174 >	01/93-06/93	10PA20C	R134a	DCP17017	A0002302211
300 SE, SEL/S320	M 104.990		03/91-06/93	10PA20C	R134a	DCP17006	A1201300215
300 SE, SEL/S320	M 104.994		07/93-10/98	7SBU16C	R134a	DCP17023	A0002302011
300 SE, SEL/S320	M 104.994	Ch No: 073224>	07/93-10/98	10PA20C	R134a	DCP17005	A0002301711
300 SE, SEL/S320	M 104.994	Ch No: 073224>	07/93-10/98	10PA20C	R134a	DCP17017	A0002302211
400 SE, SEL/S420	M 119.971		02/91-06/93	10PA20C	R134a	DCP17007	A0002300411
400 SE, SEL/S420	M 119.971		02/91-06/93	10PA20C	R134a	DCP17147	1192300011
400 SE, SEL/S420	M 119.971	Ch No: 012762>	02/91-06/93	10PA20C	R134a	DCP17015	A0002301611
500 SE, SEL	M 119.970		02/91-06/93	10PA20C	R134a	DCP17007	A0002300411
500 SE, SEL	M 119.970		02/91-06/93	10PA20C	R134a	DCP17147	1192300011
500 SE, SEL	M 119.970	Ch No: 026968>	02/91-06/93	10PA20C	R134a	DCP17015	A0002301611
600 SE, SEL	M 120.980; M 120.982		04/91-12/92	10PA20C	R134a	DCP17006	
S 280	M 104.944		07/93-10/98	7SBU16C	R134a	DCP17023	A0002302011
S 280	M 104.944	Ch No: 001153;017174 >	07/93-07/94	10PA20C	R134a	DCP17005	A0002301711
S 280	M 104.944	Ch No: 001153;017174 >	07/93-07/94	10PA20C	R134a	DCP17017	A0002302211
S 300 Turbo-D	OM 606.961		05/96-10/98	7SBU16C	R134a	DCP17023	
S 350 Turbo-D	OM 603.971		01/93-10/98	10PA20C	R134a	DCP17008	A0002300011
S 350 Turbo-D	OM 603.971	Ch No: 018394>	01/93-10/98	10PA20C	R134a	DCP17017	A0002302211
S 420	M 119.971		07/93-08/98	10PA20C	R134a	DCP17147	1192300011
S 420	M 119.971		07/93-10/98	10PA20C	R134a	DCP17007	A0002300411
S 420	M 119.971	Ch No: 012762>	07/93-10/98	10PA20C	R134a	DCP17015	A0002301611
S 500	M 119.970		07/93-10/98	10PA20C	R134a	DCP17007	A0002300411
S 500	M 119.970	Ch No: 026968>	07/93-10/98	10PA20C	R134a	DCP17015	A0002301611
S 500	M 119.970; M 119.980		01/93-08/98	10PA20C	R134a	DCP17147	1192300011
S 600	M 120.980; M 120.982		07/93-10/98	10PA20C	R134a	DCP17006	
<b>S-CLASS (W220) (98-05)</b>							
S 55 AMG	M 113.986		04/99-08/05	7SEU17C	R134a	DCP17108	A0012302611
S 55 AMG	M 113.986		01/00-09/04	7SEU17C	R134a	DCP17064	A0002305111
S 55 AMG	M 113.986		08/01-09/02	7SEU17C	R134a	DCP17038	A0012305511
S 55 AMG	M 113.986		08/01-09/02	7SEU17C	R134a	DCP17043	A0012300011
S 55 AMG Kompressor	M 113.991		06/02-09/02	7SEU17C	R134a	DCP17038	A0012305511
S 55 AMG Kompressor	M 113.991		06/02-09/02	7SEU17C	R134a	DCP17043	A0012300011
S 55 AMG Kompressor	M 113.991		06/02-09/04	7SEU17C	R134a	DCP17026	A0002305111
S 55 AMG Kompressor	M 113.991		06/02-08/05	7SEU17C	R134a	DCP17040	A0012301411
S 55 AMG Kompressor	M 113.991		06/02-08/05	7SEU17C	R134a	DCP17108	A0012302611
S 55 AMG Kompressor	M 113.991	All Climate zones	06/02-08/05	7SEU17C	R134a	DCP17119	
S 65 AMG	M 275.980		03/04-09/04	7SEU17C	R134a	DCP17041	
S 280	M 112.922		03/99-09/04	7SEU17C	R134a	DCP17064	A0002305111
S 280	M 112.922		09/02-09/04	7SEU17C	R134a	DCP17043	A0012300011





				TYPE	GAS	DENSO PN	OE
<b>MERCEDES-BENZ</b> <i>Continued</i>							
<b>S-CLASS (W220) (98-05)</b> <i>Continued</i>							
S 320	M 112.944		10/98-09/04	7SEU17C	R134a	DCP17064	A0002305111
S 320	M 112.944		09/02-09/04	7SEU17C	R134a	DCP17043	A0012300011
S 320 CDI	OM 613.960;OM 648.960		01/00-09/04	7SEU17C	R134a	DCP17064	
S 350	M 112.972		09/02-09/04	7SEU17C	R134a	DCP17026	A0002305111
S 350	M 112.972		09/02-09/04	7SEU17C	R134a	DCP17043	A0012300011
S 350	M 112.972		09/02-08/05	7SEU17C	R134a	DCP17040	A0012301411
S 350	M 112.972	All Climate zones	09/02-08/05	7SEU17C	R134a	DCP17119	
S 350 4-matic	M 112.975		06/03-09/04	7SEU17C	R134a	DCP17026	A0002305111
S 350 4-matic	M 112.975		06/03-09/04	7SEU17C	R134a	DCP17043	A0012300011
S 350 4-matic	M 112.975		06/03-08/05	7SEU17C	R134a	DCP17040	A0012301411
S 350 4-matic	M 112.975	All Climate zones	06/03-08/05	7SEU17C	R134a	DCP17119	
S 400 CDI	OM 628.960		02/03-08/05	7SEU17C	R134a	DCP17102	
S 400 CDI	OM 628.960	All Climate zones	06/00-08/05	7SEU17C	R134a	DCP17090	
S 430	M 113.941		10/98-09/04	7SEU17C	R134a	DCP17064	A0002305111
S 430	M 113.941		10/98-08/05	7SEU17C	R134a	DCP17108	A0012302611
S 430	M 113.941		08/01-09/02	7SEU17C	R134a	DCP17038	A0012305511
S 430	M 113.941		08/01-09/04	7SEU17C	R134a	DCP17043	A0012300011
S 430 4-matic	M 113.948		09/02-09/04	7SEU17C	R134a	DCP17026	A0002305111
S 430 4-matic	M 113.948		09/02-09/04	7SEU17C	R134a	DCP17043	A0012300011
S 430 4-matic	M 113.948		09/02-08/05	7SEU17C	R134a	DCP17040	A0012301411
S 430 4-matic	M 113.948	All Climate zones	09/02-08/05	7SEU17C	R134a	DCP17119	
S 500	M 113.960; M 113.966		10/98-09/04	7SEU17C	R134a	DCP17064	A0002305111
S 500	M 113.960; M 113.966		10/98-08/05	7SEU17C	R134a	DCP17108	A0012302611
S 500	M 113.960; M 113.966		08/01-09/02	7SEU17C	R134a	DCP17038	A0012305511
S 500	M 113.960; M 113.966		08/01-08/05	7SEU17C	R134a	DCP17043	A0012300011
S 500 4-matic	M 113.966		09/02-09/04	7SEU17C	R134a	DCP17026	A0002305111
S 500 4-matic	M 113.966		09/02-09/04	7SEU17C	R134a	DCP17043	A0012300011
S 500 4-matic	M 113.966		09/02-08/05	7SEU17C	R134a	DCP17040	A0012301411
S 500 4-matic	M 113.966	All Climate zones	09/02-08/05	7SEU17C	R134a	DCP17119	
S 600	M 275.950		09/02-09/04	7SEU17C	R134a	DCP17041	
S 600	M 137.970		01/00-09/04	7SEU17C	R134a	DCP17041	
<b>S-CLASS (W221) (05-13)</b>							
S 63 AMG	M 156.984		07/07-12/13	7SEU17C	R134a	DCP17139	
S 65 AMG	M 275.982		12/05-06/09	10PA15C	R134a	DCP17034	A0022308111
S 65 AMG	M 275.982		12/05-06/09	7SEU17C	R134a	DCP17131	A0022308111
S 250 CDI	OM 651.961		01/11-12/13	7SEU17C	R134a	DCP17126	
S 320 CDI	OM 642.930		12/05-08/08	7SEU17C	R134a	DCP17143	A0022308211
S 320 CDI	OM 642.930		12/05-06/09	10PA15C	R134a	DCP17034	A0022308111
S 320 CDI	OM 642.930		12/05-06/09	7SEU17C	R134a	DCP17131	A0022308111
S 320 CDI 4-matic	OM 642.932		10/06-08/08	7SEU17C	R134a	DCP17143	A0022308211
S 320 CDI 4-matic	OM 642.932		10/06-06/09	10PA15C	R134a	DCP17034	A0022308111
S 320 CDI 4-matic	OM 642.932		10/06-06/09	7SEU17C	R134a	DCP17131	A0022308111
S 350	M 272.965		10/05-12/13	7SEU17C	R134a	DCP17132	A0022307711
S 350	M 272.965	Ch No: >9220	10/05-12/13	7SEU17C	R134a	DCP17133	A0012304111
S 350 4-matic	M 272.975		02/08-12/13	7SEU17C	R134a	DCP17132	A0022307711
S 350 BlueTec	OM 642.862		04/11-12/13	7SEU17C	R134a	DCP17132	
S 350 BlueTEC 4-matic	OM 642.868		04/11-12/13	7SEU17C	R134a	DCP17132	
S 350 CDI	OM 642.930		06/09-12/13	7SEU17C	R134a	DCP17132	
S 350 CGI	M 276.950		04/11-12/13	7SEU17C	R134a	DCP17127	
S 350 CGI 4-matic	M 276.950		04/11-12/13	7SEU17C	R134a	DCP17127	
S 420 CDI	OM 629.911		10/06-06/09	7SEU17C	R134a	DCP17143	
S 450	M 273.922		06/06-12/13	7SEU17C	R134a	DCP17060	A0022301211
S 450 4-matic	M 273.924		12/05-12/13	7SEU17C	R134a	DCP17132	A0022307711
S 500	M 273.961		06/06-12/13	7SEU17C	R134a	DCP17060	A0022301211
S 500	M 273.961	Ch No: >9220	10/05-12/13	7SEU17C	R134a	DCP17133	A0012304111
S 500 CGI	M 278.932		04/11-12/13	7SEU17C	R134a	DCP17132	
S 500 CGI 4-matic	M 278.932		03/11-12/13	7SEU17C	R134a	DCP17132	
S 600	M 275.953		12/05-06/09	10PA15C	R134a	DCP17034	A0022308111
S 600	M 275.953		12/05-06/09	7SEU17C	R134a	DCP17131	A0022308111
<b>S-CLASS Coupe (C126) (80-91)</b>							
420 SEC	M 116.965		10/85-06/91	10P17C	R134a	DCP17003	
500 SEC	M 117.965		09/85-06/91	10P17C	R134a	DCP17003	
560 SEC	M 117.968		10/85-06/91	10P17C	R134a	DCP17003	
<b>S-CLASS Coupe (C140) (92-99)</b>							
500 SEC / CL 500	M 119.970; M 119.980		10/92-06/93	10PA20C	R134a	DCP17007	A0002300411





				TYPE	GAS	DENSO PN	OE
<b>MERCEDES-BENZ</b> <i>Continued</i>							
<b>S-CLASS Coupe (C140) (92-99)</b> <i>Continued</i>							
500 SEC / CL 500	M 119.970; M 119.980			10PA20C	R134a	DCP17147	1192300011
500 SEC / CL 500	M 119.970; M 119.980	Ch No: 010821>		7SBU16C	R134a	DCP17023	A0002302011
500 SEC / CL 500	M 119.970; M 119.980	Ch No: 026967>		10PA20C	R134a	DCP17015	A0002301611
SEC/CL 420	M 119.971			10PA20C	R134a	DCP17007	A0002300411
SEC/CL 420	M 119.971	Ch No: 012761>		10PA20C	R134a	DCP17015	A0002301611
SEC/CL 420	M 119.971; M 119.981			10PA20C	R134a	DCP17147	1192300011
SEC/CL 600	M 120.980; M 120.982			10PA20C	R134a	DCP17006	A1201300215
SEC/CL 600	M 120.980; M 120.982			10PA20C	R134a	DCP17005	A0002301711
SEC/CL 600	M 120.980; M 120.982	Ch No: 000023>		10PA20C	R134a	DCP17017	A0002302211
<b>S-CLASS Coupe (C215) (99-06)</b>							
CL 55 AMG	M 113.986			7SEU17C	R134a	DCP17064	
CL 55 AMG Kompressor	M 113.991			7SEU17C	R134a	DCP17026	
CL 55 AMG Kompressor	M 113.991			7SEU17C	R134a	DCP17040	A0012301411
CL 55 AMG Kompressor	M 113.991	All Climate zones		7SEU17C	R134a	DCP17119	
CL 65 AMG	M 275.980			7SEU17C	R134a	DCP17041	
CL 500	M 113.960			7SEU17C	R134a	DCP17064	
CL 600	M 275.950			7SEU17C	R134a	DCP17026	
CL 600	M 275.950			7SEU17C	R134a	DCP17040	A0012301411
CL 600	M 275.950	All Climate zones		7SEU17C	R134a	DCP17119	
CL 600	M 137.970			7SEU17C	R134a	DCP17040	A0012301411
CL 600	M 137.970			7SEU17C	R134a	DCP17026	
CL 600	M 137.970	All Climate zones		7SEU17C	R134a	DCP17119	
<b>S-CLASS Coupe (C216) (06-13)</b>							
CL 63 AMG	M 157.980			7SEU17C	R134a	DCP17132	
CL 63 AMG	M 156.984			7SEU17C	R134a	DCP17139	
CL 65 AMG	M 275.982			7SEU17C	R134a	DCP17131	
CL 500	M 278.920			7SEU17C	R134a	DCP17132	
CL 500	M 273.961	Ch No: 010649>		7SEU17C	R134a	DCP17132	A0022307711
CL 500	M 273.961	Japan;USA		7SEU17C	R134a	DCP17060	
CL 500 4-matic	M 278.920			7SEU17C	R134a	DCP17132	
CL 500 4-matic	M 273.968	Ch No: 010649>		7SEU17C	R134a	DCP17132	A0022307711
CL 500 4-matic	M 273.968	Japan;USA		7SEU17C	R134a	DCP17060	
CL 600	M 275.953			7SEU17C	R134a	DCP17131	
<b>SL (R107) (71-89)</b>							
300 SL	M 103.982			10P15C	R134a	DCP17001	A0002302411
300 SL	M 103.982			10PA15C	R134a	DCP17012	A1021310001
420 SL	M 116.964			10P17C	R134a	DCP17003	
<b>SL (R129) (89-01)</b>							
280	M 104.943	Ch No: >001545;006577		10PA17C	R134a	DCP17010	A0002300511
280	M 104.943	Ch No: 001546;006578>		10PA17C	R134a	DCP17019	A0002303611
280	M 112.923			10PA17C	R134a	DCP17010	A0002300511
280	M 112.923			10PA17C	R134a	DCP17019	A0002303611
300	M 103.984			10PA17C	R134a	DCP17010	
300-24	M 104.981			10PA17C	R134a	DCP17010	
320	M 104.991	Ch No: >022857		10PA17C	R134a	DCP17010	A0002300511
320	M 104.991	Ch No: 022858>		10PA17C	R134a	DCP17019	A0002303611
320	M 112.943			10PA17C	R134a	DCP17010	A0002300511
320	M 112.943			10PA17C	R134a	DCP17019	A0002303611
500	M 119.960;M 119.972;M 119.982			10PA17C	R134a	DCP17011	A1191300015
500	M 119.982	Ch No: 006301>		10PA17C	R134a	DCP17020	A0002303711
600	M 120.983	Ch No: >001132		10PA17C	R134a	DCP17010	A0002300511
600	M 120.983	Ch No: 001133>		10PA17C	R134a	DCP17019	A0002303611
<b>SL (R198) (57-63)</b>							
300 SL	M 198.982			10PA17C	R134a	DCP17010	
<b>SL (R230) (01-12)</b>							
55 AMG	M 113.992			7SEU17C	R134a	DCP17064	





				TYPE	GAS	DENSO PN	OE
<b>MERCEDES-BENZ</b> <i>Continued</i>							
<b>SL (R230) (01-12)</b> <i>Continued</i>							
55 AMG Kompressor	M 113.992		06/02-03/06	7SEU17C	R134a	DCP17085	
350	M 272.966		03/06-01/08	7SEU17C	R134a	DCP17026	A0012306211
350	M 272.966		03/06-01/08	7SEU17C	R134a	DCP17038	A0012305511
350	M 272.966		03/06-01/12	7SEU17C	R134a	DCP17040	A0012301411
350	M 272.966		03/06-01/12	7SEU17C	R134a	DCP17108	A0012302611
350	M 272.966	All Climate zones	03/06-01/12	7SEU17C	R134a	DCP17119	
350	M 112.973	Ch No: F025509>F034547	03/03-01/12	7SEU17C	R134a	DCP17085	
500	M 113.963		10/01-07/02	7SEU17C	R134a	DCP17064	
500	M 113.963		07/02-10/05	7SEU17C	R134a	DCP17085	
500	M 273.965		03/06-01/08	7SEU17C	R134a	DCP17026	A0012306211
500	M 273.965		03/06-01/08	7SEU17C	R134a	DCP17038	A0012305511
500	M 273.965		03/06-01/12	7SEU17C	R134a	DCP17040	A0012301411
500	M 273.965		03/06-01/12	7SEU17C	R134a	DCP17108	A0012302611
500	M 273.965	All Climate zones	03/06-01/12	7SEU17C	R134a	DCP17119	
<b>SL (R231) (12-)</b>							
350	M 276.954		02/12-	6SBU16C	R134a	DCP17155	
400	M 276.825		04/14-	6SBU16C	R134a	DCP17155	
500	M 278.927		01/12-	6SBU16C	R134a	DCP17155	
<b>SLC (R172) (16-)</b>							
250 d	OM 651.980		01/16-10/17	6SBU16C	R134a	DCP17179	A0008302700
<b>SLK (R170) (96-04)</b>							
32 AMG Kompressor	M 112.960		10/01-12/03	7SBU16C	R134a	DCP17023	A0002302011
32 AMG Kompressor	M 112.960		10/01-12/03	7SBU16C	R134a	DCP17080	A0002307611
200	M 111.946		09/96-03/00	7SBU16C	R134a	DCP17023	
200 Kompressor	M 111.943;M 111.958		10/96-12/03	7SBU16C	R134a	DCP17023	
230 Kompressor	M 111.973;M 111.983		09/96-12/03	7SBU16C	R134a	DCP17023	
320	M 112.947		03/00-12/03	7SBU16C	R134a	DCP17023	
<b>SLK (R171) (04-11)</b>							
55 AMG	M 113.989		06/04-02/11	6SEU14C	R134a	DCP17046	
200 Kompressor	M 271.944		03/04-12/07	6SEU14C	R134a	DCP17051	
200 Kompressor	M 271.954		01/08-02/11	6SEU16C	R134a	DCP17103	
280	M 272.942		01/05-02/11	6SEU14C	R134a	DCP17046	
300	M 272.942		04/09-02/11	6SEU16C	R134a	DCP17110	
350	M 272.963		06/04-12/07	6SEU14C	R134a	DCP17046	A0012300711
350	M 272.963		06/04-12/07	6SEU16C	R134a	DCP17068	A0012305411
350	M 272.969		01/08-02/11	6SEU16C	R134a	DCP17110	
<b>SLK (R172) (11-)</b>							
55 AMG	M 152.980		01/12-	6SEU16C	R134a	DCP17161	
200	M 271.860; M 271.861		02/11-	6SEU16C	R134a	DCP17112	
250	M 271.860; M 271.861		02/11-	6SEU16C	R134a	DCP17112	
250 CDI / d	OM 651.980		01/12-	6SBU16C	R134a	DCP17154	
250 CDI / d	OM 651.980		01/12-	6SBU16C	R134a	DCP17179	A0008302700
350	M 276.956		02/11-	6SBU16C	R134a	DCP17177	A0008302300
350	M 276.956		02/11-	6SBU16C	R134a	DCP17179	A0008302700
<b>SPRINTER 2-t (901, 902) (95-06)</b>							
2.1 208 CDI	OM 611.987		04/00-05/06	7SBU16C	R134a	DCP17023	
2.1 211 CDI	OM 611.981		04/00-05/06	7SBU16C	R134a	DCP17023	
2.1 213 CDI	OM 611.981		04/00-05/06	7SBU16C	R134a	DCP17023	
2.3 208 D	OM 601.943		01/95-04/00	10PA17C	R134a	DCP17011	A1191300015
2.3 208 D	OM 601.943		09/96-04/00	10PA17C	R134a	DCP17020	A0002303711
2.3 208 D	OM 601.943	Ch No: 530441>	01/95-04/00	7SBU16C	R134a	DCP17023	A0002302011
2.3 208 D	OM 601.943	Ch No: 943530441>	09/96-04/00	7SBU16C	R134a	DCP17023	A0002302011
2.3 208 D	OM 601.943	Isotherm vehicle	01/95-04/00	10PA17C	R134a	DCP17020	A0002303711
2.3 214	M 111.979;M 111.984		02/95-05/06	10PA17C	R134a	DCP17011	A1191300015
2.3 214	M 111.979;M 111.984	Ch No: 09/96;002029>	02/95-05/06	7SBU16C	R134a	DCP17023	A0002302011
2.3 214 NGT	M 111.979;M 111.984		02/95-05/06	7SBU16C	R134a	DCP17023	
2.7 216 CDI	OM 612.981		04/00-05/06	7SBU16C	R134a	DCP17023	
2.9 210 D	OM 602.980		01/97-04/00	10PA17C	R134a	DCP17011	A1191300015
2.9 210 D	OM 602.980		01/97-04/00	10PA17C	R134a	DCP17020	A0002303711
2.9 210 D	OM 602.980	Ch No: 980066379>	01/97-04/00	7SBU16C	R134a	DCP17023	A0002302011
2.9 212 D	OM 602.980		02/95-04/00	10PA17C	R134a	DCP17011	A1191300015











				TYPE	GAS	DENSO PN	OE
<b>MERCEDES-BENZ</b> <i>Continued</i>							
<b>SPRINTER 2-t (901, 902) (95-06)</b> <i>Continued</i>							
2.9 212 D	OM 602.980	Ch No: 066379>	02/95-04/00	7SBU16C	R134a	DCP17023	A0002302011
<b>SPRINTER 3,5-t (906) (06-)</b>							
1.8 316	M 271.951		09/08-	7SEU17C	R134a	DCP17072	A0022301911
1.8 316	M 271.951	For vehicles with front and rear A/C	09/08-	7SBU17C	R134a	DCP17151	A0032309011
1.8 316 LGT	M 271.951		09/08-	7SEU17C	R134a	DCP17072	A0022301911
1.8 316 LGT	M 271.951		09/08-	7SEU17C	R134a	DCP17152	
1.8 316 LGT	M 271.951	For vehicles with front and rear A/C	09/08-	7SBU17C	R134a	DCP17151	A0032309011
1.8 316 NGT	M 271.951		09/08-	7SEU17C	R134a	DCP17072	A0022301911
1.8 316 NGT	M 271.951	For vehicles with front and rear A/C	09/08-	7SBU17C	R134a	DCP17151	A0032309011
2.1 309 CDI	OM 646.984		06/06-12/09	7SEU17C	R134a	DCP17072	A0022301911
2.1 309 CDI	OM 646.984	For vehicles with front and rear A/C	06/06-12/09	7SBU17C	R134a	DCP17151	A0032309011
2.1 309 CDI	OM 646.984	Heavy duty version	06/06-12/09	10S17C	R134a	DCP17150	0012307011
2.1 310 CDI	OM 651.955	Heavy duty version	03/09-	10S17C	R134a	DCP17150	0012307011
2.1 310 CDI	OM 651.955;OM 651.956		03/09-	7SEU17C	R134a	DCP17072	A0022301911
2.1 310 CDI	OM 651.955;OM 651.956	For vehicles with front and rear A/C	03/09-	7SBU17C	R134a	DCP17151	A0032309011
2.1 311 CDI	OM 651.955		05/16-	10S17C	R134a	DCP17122	
2.1 311 CDI	OM 646.985		06/06-12/09	7SEU17C	R134a	DCP17072	A0022301911
2.1 311 CDI	OM 646.985	For vehicles with front and rear A/C	06/06-12/09	7SBU17C	R134a	DCP17151	A0032309011
2.1 311 CDI	OM 646.985	Heavy duty version	06/06-12/09	10S17C	R134a	DCP17150	0012307011
2.1 311 CDI 4x4	OM 646.985		02/08-12/09	7SEU17C	R134a	DCP17072	A0022301911
2.1 311 CDI 4x4	OM 646.985	For vehicles with front and rear A/C	02/08-12/09	7SBU17C	R134a	DCP17151	A0032309011
2.1 311 CDI 4x4	OM 646.985	Heavy duty version	02/08-12/09	10S17C	R134a	DCP17150	0012307011
2.1 313 CDI	OM 651.940;OM 651.955;OM 651.956		06/06-	7SEU17C	R134a	DCP17072	A0022301911
2.1 313 CDI	OM 651.940;OM 651.955;OM 651.956	For vehicles with front and rear A/C	06/06-	7SBU17C	R134a	DCP17151	A0032309011
2.1 313 CDI	OM 651.955		08/11-05/16	7SEU17C	R134a	DCP17072	A0022301911
2.1 313 CDI	OM 651.955	For vehicles with front and rear A/C	08/11-05/16	7SBU17C	R134a	DCP17151	A0032309011
2.1 313 CDI	OM 646.986		06/06-05/16	7SEU17C	R134a	DCP17072	A0022301911
2.1 313 CDI	OM 646.986		06/06-	7SBU16C	R134a	DCP17080	A0002307611
2.1 313 CDI	OM 646.986		06/06-	7SEU17C	R134a	DCP17102	A0012303211
2.1 313 CDI	OM 646.986	All Climate zones	06/06-	7SEU17C	R134a	DCP17090	
2.1 313 CDI	OM 646.986	For vehicles with front and rear A/C	06/06-05/16	7SBU17C	R134a	DCP17151	A0032309011
2.1 313 CDI	OM 646.986	Heavy duty version	06/06-	10S17C	R134a	DCP17122	A0012307111
2.1 313 CDI 4x4	OM 651.955		06/06-	7SEU17C	R134a	DCP17072	A0022301911
2.1 313 CDI 4x4	OM 651.955	For vehicles with front and rear A/C	06/06-	7SBU17C	R134a	DCP17151	A0032309011
2.1 314 CDI	OM 651.955		05/16-	10S17C	R134a	DCP17122	
2.1 314 CDI 4x4	OM 651.955		05/16-	10S17C	R134a	DCP17122	
2.1 315 CDI	OM 646.986;OM 646.989;OM 646.990		06/06-12/09	7SEU17C	R134a	DCP17072	A0022301911
2.1 315 CDI	OM 646.986;OM 646.989;OM 646.990	For vehicles with front and rear A/C	06/06-12/09	7SBU17C	R134a	DCP17151	A0032309011
2.1 315 CDI 4x4	OM 646.986;OM 646.989;OM 646.990		02/08-12/09	7SEU17C	R134a	DCP17072	A0022301911
2.1 315 CDI 4x4	OM 646.986;OM 646.989;OM 646.990	For vehicles with front and rear A/C	02/08-12/09	7SBU17C	R134a	DCP17151	A0032309011
2.1 316 CDI	OM 651.955;OM 651.957		03/09-	7SEU17C	R134a	DCP17072	A0022301911
2.1 316 CDI	OM 651.955;OM 651.957	For vehicles with front and rear A/C	03/09-	7SBU17C	R134a	DCP17151	A0032309011
2.1 316 CDI	OM 651.955;OM 651.957	Heavy duty version	03/09-	10S17C	R134a	DCP17122	





				TYPE	GAS	DENSO PN	OE	
<b>MERCEDES-BENZ</b> <i>Continued</i>								
<b>SPRINTER 3,5-t (906) (06-)</b> <i>Continued</i>								
2.1 316 CDI 4x4	OM 651.955;OM 651.957			03/09-	7SEU17C	R134a	DCP17072	A0022301911
2.1 316 CDI 4x4	OM 651.955;OM 651.957	For vehicles with front and rear A/C		03/09-	7SBU17C	R134a	DCP17151	A0032309011
3.0 318 CDI	OM 642.896; OM 642.992; OM 642.993			06/06-07/09	10S17C	R134a	DCP17122	A0012307111
3.0 318 CDI	OM 642.896;OM 642.986;OM 642.992; OM 642.993			06/06-12/09	7SEU17C	R134a	DCP17072	A0022301911
3.0 318 CDI	OM 642.896;OM 642.986;OM 642.992; OM 642.993	For vehicles with front and rear A/C		06/06-12/09	7SBU17C	R134a	DCP17151	A0032309011
3.0 318 CDI 4x4	OM 642.896;OM 642.986;OM 642.992; OM 642.993			02/08-12/09	7SEU17C	R134a	DCP17072	A0022301911
3.0 318 CDI 4x4	OM 642.896;OM 642.986;OM 642.992; OM 642.993	For vehicles with front and rear A/C		02/08-12/09	7SBU17C	R134a	DCP17151	A0032309011
3.0 319 CDI / BlueTEC	OM 642.896; OM 642.898; OM 642.986; OM 642.992	Heavy duty version		03/09-	10S17C	R134a	DCP17121	A0012306911
3.0 319 CDI / BlueTEC	OM 642.896;OM 642.898;OM 642.986; OM 642.992			03/09-	7SEU17C	R134a	DCP17072	A0022301911
3.0 319 CDI / BlueTEC	OM 642.896;OM 642.898;OM 642.986; OM 642.992			07/09-	10S17C	R134a	DCP17121	A0012306911
3.0 319 CDI / BlueTEC	OM 642.896;OM 642.898;OM 642.986; OM 642.992	For vehicles with front and rear A/C		03/09-	7SBU17C	R134a	DCP17151	A0032309011
3.0 319 CDI / BlueTEC 4x4	OM 642.896;OM 642.898;OM 642.986; OM 642.992			03/09-	7SEU17C	R134a	DCP17072	A0022301911
3.0 319 CDI / BlueTEC 4x4	OM 642.896;OM 642.898;OM 642.986; OM 642.992	For vehicles with front and rear A/C		03/09-	7SBU17C	R134a	DCP17151	A0032309011
3.5 324	M 272.979			06/06-12/13	7SEU17C	R134a	DCP17072	A0022301911
3.5 324	M 272.979			06/06-12/13	10S17C	R134a	DCP17122	A0012307111
3.5 324	M 272.979	For vehicles with front and rear A/C		06/06-12/13	7SBU17C	R134a	DCP17151	A0032309011
<b>SPRINTER 3-t (903) (95-06)</b>								
2.1 308 CDI	OM 611.987			04/00-05/06	7SBU16C	R134a	DCP17023	
2.1 311 CDI	OM 611.981			04/00-05/06	10PA17C	R134a	DCP17011	A1191300015
2.1 311 CDI	OM 611.981			04/00-05/06	7SBU16C	R134a	DCP17023	
2.1 311 CDI 4x4	OM 611.981			08/02-05/06	7SBU16C	R134a	DCP17023	
2.1 313 CDI	OM 611.981			04/00-05/06	7SBU16C	R134a	DCP17023	
2.1 313 CDI 4x4	OM 611.981			08/02-05/06	7SBU16C	R134a	DCP17023	
2.3 308 D 2.3	OM 601.943			02/95-04/00	10PA17C	R134a	DCP17011	A1191300015
2.3 308 D 2.3	OM 601.943			11/96-04/00	10PA17C	R134a	DCP17020	A0002303711
2.3 308 D 2.3	OM 601.943	Ch No: 530441>		02/95-04/00	7SBU16C	R134a	DCP17023	A0002302011
2.3 308 D 2.3	OM 601.943	Ch No: 943530441>		11/96-04/00	7SBU16C	R134a	DCP17023	A0002302011
2.3 308 D 2.3	OM 601.943	Isotherm vehicle		02/95-04/00	10PA17C	R134a	DCP17020	A0002303711
2.3 314	M 111.979;M 111.984			02/95-05/06	10PA17C	R134a	DCP17011	A1191300015
2.3 314	M 111.979;M 111.984	Ch No: 09/96;002029>		02/95-05/06	7SBU16C	R134a	DCP17023	A0002302011
2.3 314	M 111.979;M 111.984	Isotherm vehicle		02/95-05/06	10PA17C	R134a	DCP17020	A0002303711
2.3 314 NGT	M 111.979;M 111.984			02/95-05/06	10PA17C	R134a	DCP17020	A0002303711
2.3 314 NGT	M 111.979;M 111.984			02/95-05/06	7SBU16C	R134a	DCP17023	A0002302011
2.7 316 CDI	OM 612.981;OM 647.981			04/00-05/06	7SBU16C	R134a	DCP17023	
2.7 316 CDI 4x4	OM 612.981;OM 647.981			08/02-05/06	7SBU16C	R134a	DCP17023	
2.9 310 D 2.9	OM 602.980			02/95-04/00	10PA17C	R134a	DCP17011	A1191300015
2.9 310 D 2.9	OM 602.980			02/95-04/00	10PA17C	R134a	DCP17020	A0002303711
2.9 310 D 2.9	OM 602.980	Ch No: 980066379>		02/95-04/00	7SBU16C	R134a	DCP17023	A0002302011
2.9 310 D 4x4	OM 602.980			05/97-08/02	10PA17C	R134a	DCP17011	A1191300015
2.9 310 D 4x4	OM 602.980			05/97-08/02	10PA17C	R134a	DCP17020	A0002303711
2.9 310 D 4x4	OM 602.980	Ch No: 980066379>		05/97-08/02	7SBU16C	R134a	DCP17023	A0002302011
2.9 312 D 2.9	OM 602.980			02/95-04/00	10PA17C	R134a	DCP17011	A1191300015
2.9 312 D 2.9	OM 602.980	Ch No: 066379>		02/95-04/00	7SBU16C	R134a	DCP17023	A0002302011
2.9 312 D 2.9	OM 602.980	Isotherm vehicle		02/95-04/00	10PA17C	R134a	DCP17020	A0002303711
2.9 312 D 2.9 4x4	OM 602.980			05/97-08/02	10PA17C	R134a	DCP17011	A1191300015
2.9 312 D 2.9 4x4	OM 602.980			05/97-08/02	10PA17C	R134a	DCP17020	A0002303711
2.9 312 D 2.9 4x4	OM 602.980	Ch No: 980066379>		05/97-08/02	7SBU16C	R134a	DCP17023	A0002302011
<b>SPRINTER 3-t (906) (06-)</b>								
1.8 216	M 271.951			09/08-	7SEU17C	R134a	DCP17072	A0022301911





				TYPE	GAS	DENSO PN	OE
<b>MERCEDES-BENZ</b> <i>Continued</i>							
<b>SPRINTER 3-t (906) (06-)</b> <i>Continued</i>							
1.8 216	M 271.951	For vehicles with front and rear A/C	09/08-	7SBU17C	R134a	DCP17151	A0032309011
2.1 209 CDI	OM 646.984		06/06-12/09	7SEU17C	R134a	DCP17072	A0022301911
2.1 209 CDI	OM 646.984		06/06-12/09	7SEU17C	R134a	DCP17152	A0022301811
2.1 209 CDI	OM 646.984	For vehicles with front and rear A/C	06/06-12/09	7SBU17C	R134a	DCP17151	A0032309011
2.1 210 CDI	OM 651.955		03/09-	7SEU17C	R134a	DCP17072	A0022301911
2.1 210 CDI	OM 651.955		07/09-	7SEU17C	R134a	DCP17152	A0022301811
2.1 210 CDI	OM 651.955	For vehicles with front and rear A/C	03/09-	7SBU17C	R134a	DCP17151	A0032309011
2.1 211 CDI	OM 651.955		04/16-	10S17C	R134a	DCP17122	
2.1 211 CDI	OM 646.985		06/06-12/09	7SEU17C	R134a	DCP17072	A0022301911
2.1 211 CDI	OM 646.985		06/06-12/09	7SEU17C	R134a	DCP17152	A0022301811
2.1 211 CDI	OM 646.985	For vehicles with front and rear A/C	06/06-12/09	7SBU17C	R134a	DCP17151	A0032309011
2.1 211 CDI	OM 646.985	Heavy duty version	06/06-12/09	10S17C	R134a	DCP17150	0012307011
2.1 213 CDI	OM 651.955;OM 651.957		06/06-	7SEU17C	R134a	DCP17072	A0022301911
2.1 213 CDI	OM 651.955;OM 651.957	For vehicles with front and rear A/C	06/06-	7SBU17C	R134a	DCP17151	A0032309011
2.1 213 CDI	OM 646.986		06/06-12/09	7SEU17C	R134a	DCP17072	A0022301911
2.1 213 CDI	OM 646.986		06/06-12/09	7SEU17C	R134a	DCP17102	A0012303211
2.1 213 CDI	OM 646.986		06/06-12/09	7SEU17C	R134a	DCP17152	A0022301811
2.1 213 CDI	OM 646.986	All Climate zones	06/06-12/09	7SEU17C	R134a	DCP17090	
2.1 213 CDI	OM 646.986	For vehicles with front and rear A/C	06/06-12/09	7SBU17C	R134a	DCP17151	A0032309011
2.1 214 CDI	OM 651.955		04/16-	10S17C	R134a	DCP17122	
2.1 215 CDI	OM 646.986; OM 646.989; OM 646.990		06/06-12/09	7SEU17C	R134a	DCP17152	A0022301811
2.1 215 CDI	OM 646.986;OM 646.989;OM 646.990		06/06-12/09	7SEU17C	R134a	DCP17072	A0022301911
2.1 215 CDI	OM 646.986;OM 646.989;OM 646.990	For vehicles with front and rear A/C	06/06-12/09	7SBU17C	R134a	DCP17151	A0032309011
2.1 216 CDI	OM 651.955; OM 651.957		07/09-	7SEU17C	R134a	DCP17152	A0022301811
2.1 216 CDI	OM 651.955;OM 651.957		06/06-	7SEU17C	R134a	DCP17072	A0022301911
2.1 216 CDI	OM 651.955;OM 651.957	For vehicles with front and rear A/C	06/06-	7SBU17C	R134a	DCP17151	A0032309011
3.0 218 CDI	OM 642.896; OM 642.992		06/06-12/09	7SEU17C	R134a	DCP17152	A0022301811
3.0 218 CDI	OM 642.896; OM 642.992; OM 642.993		06/06-12/09	10S17C	R134a	DCP17122	A0012307111
3.0 218 CDI	OM 642.896;OM 642.992;OM 642.993		06/06-12/09	7SEU17C	R134a	DCP17072	A0022301911
3.0 218 CDI	OM 642.896;OM 642.992;OM 642.993	For vehicles with front and rear A/C	06/06-12/09	7SBU17C	R134a	DCP17151	A0032309011
3.0 219 CDI / BlueTEC	OM 642.896; OM 642.992		07/09-05/16	10S17C	R134a	DCP17121	A0012306911
3.0 219 CDI / BlueTEC	OM 642.896; OM 642.992		07/09-	7SEU17C	R134a	DCP17152	A0022301811
3.0 219 CDI / BlueTEC	OM 642.896;OM 642.992		03/09-	7SEU17C	R134a	DCP17072	A0022301911
3.0 219 CDI / BlueTEC	OM 642.896;OM 642.992	For vehicles with front and rear A/C	03/09-	7SBU17C	R134a	DCP17151	A0032309011
3.5 224	M 272.979		06/06-12/13	10S17C	R134a	DCP17122	A0012307111
3.5 224	M 272.979		06/06-	7SEU17C	R134a	DCP17072	A0022301911
3.5 224	M 272.979	For vehicles with front and rear A/C	06/06-	7SBU17C	R134a	DCP17151	A0032309011
<b>SPRINTER 4,6-t (906) (06-)</b>							
2.1 411 CDI	OM 646.985		06/09-12/18	7SEU17C	R134a	DCP17072	A0022301911
2.1 411 CDI	OM 646.985	For vehicles with front and rear A/C	06/09-12/18	7SBU17C	R134a	DCP17151	A0032309011
2.1 413 CDI	OM 651.955; OM 651.956		06/06-05/16	7SEU17C	R134a	DCP17072	A0022301911
2.1 413 CDI	OM 651.955; OM 651.956	For vehicles with front and rear A/C	06/06-05/16	7SBU17C	R134a	DCP17151	A0032309011
2.1 415 CDI	OM 646.986;OM 646.989;OM 646.990		06/06-12/09	7SEU17C	R134a	DCP17072	A0022301911
2.1 415 CDI	OM 646.986;OM 646.989;OM 646.990	For vehicles with front and rear A/C	06/06-12/09	7SBU17C	R134a	DCP17151	A0032309011
2.1 416 CDI	OM 651.955;OM 651.957		03/09-	7SEU17C	R134a	DCP17072	A0022301911
2.1 416 CDI	OM 651.955;OM 651.957	For vehicles with front and rear A/C	03/09-	7SBU17C	R134a	DCP17151	A0032309011

				TYPE	GAS	DENSO PN	OE	
<b>MERCEDES-BENZ</b> <i>Continued</i>								
<b>SPRINTER 4,6-t (906) (06-)</b> <i>Continued</i>								
3.0 418 CDI	OM 642.896;OM 642.986;OM 642.992;OM 642.993			06/06-05/16	7SEU17C	R134a	DCP17072	A0022301911
3.0 418 CDI	OM 642.896;OM 642.986;OM 642.992;OM 642.993	For vehicles with front and rear A/C		06/06-05/16	7SBU17C	R134a	DCP17151	A0032309011
3.0 419 CDI	OM 642.896;OM 642.898;OM 642.986;OM 642.992			03/09-	7SEU17C	R134a	DCP17072	A0022301911
3.0 419 CDI	OM 642.896;OM 642.898;OM 642.986;OM 642.992	For vehicles with front and rear A/C		03/09-	7SBU17C	R134a	DCP17151	A0032309011
3.5 424	M 272.979			06/06-12/13	7SEU17C	R134a	DCP17072	A0022301911
3.5 424	M 272.979	For vehicles with front and rear A/C		06/06-12/13	7SBU17C	R134a	DCP17151	A0032309011
<b>SPRINTER 4-t (904) (96-06)</b>								
2.1 408 CDI	OM 611.987			04/00-05/06	7SBU16C	R134a	DCP17023	
2.1 411 CDI	OM 611.981			04/00-05/06	7SBU16C	R134a	DCP17023	
2.1 411 CDI 4x4	OM 611.981			04/00-05/06	7SBU16C	R134a	DCP17023	
2.1 413 CDI	OM 611.981			04/00-05/06	7SBU16C	R134a	DCP17023	
2.1 413 CDI 4x4	OM 611.981			04/00-05/06	7SBU16C	R134a	DCP17023	
2.3 408 D	OM 601.943			02/96-05/06	10PA17C	R134a	DCP17011	A1191300015
2.3 408 D	OM 601.943	Ch No: 530441>		02/96-05/06	7SBU16C	R134a	DCP17023	A0002302011
2.3 408 D	OM 601.943	Isotherm vehicle		02/96-05/06	10PA17C	R134a	DCP17020	A0002303711
2.3 414	M 111.979; M 111.984			02/96-05/06	7SBU16C	R134a	DCP17023	
2.3 414	M 111.979;M 111.984			02/95-05/06	10PA17C	R134a	DCP17011	A1191300015
2.3 414	M 111.979;M 111.984	Ch No: 09/96;002029>		02/95-05/06	7SBU16C	R134a	DCP17023	A0002302011
2.3 414	M 111.979;M 111.984	Isotherm vehicle		02/95-05/06	10PA17C	R134a	DCP17020	A0002303711
2.7 416 CDI	OM 612.981; OM 647.981			04/00-05/06	10PA17C	R134a	DCP17011	A1191300015
2.7 416 CDI	OM 612.981;OM 647.981			04/00-05/06	7SBU16C	R134a	DCP17023	
2.7 416 CDI 4x4	OM 612.981;OM 647.981			04/00-05/06	7SBU16C	R134a	DCP17023	
2.9 410 D	OM 602.980			01/97-05/06	10PA17C	R134a	DCP17011	A1191300015
2.9 410 D	OM 602.980			01/97-05/06	10PA17C	R134a	DCP17020	A0002303711
2.9 410 D	OM 602.980	Ch No: 980066379>		01/97-05/06	7SBU16C	R134a	DCP17023	A0002302011
2.9 410 D 4x4	OM 602.980			05/97-05/06	10PA17C	R134a	DCP17011	A1191300015
2.9 410 D 4x4	OM 602.980			05/97-05/06	10PA17C	R134a	DCP17020	A0002303711
2.9 410 D 4x4	OM 602.980	Ch No: 980066379>		05/97-05/06	7SBU16C	R134a	DCP17023	A0002302011
2.9 412 D	OM 602.980			02/96-05/06	10PA17C	R134a	DCP17011	A1191300015
2.9 412 D	OM 602.980			02/96-05/06	10PA17C	R134a	DCP17020	A0002303711
2.9 412 D	OM 602.980	Ch No: 066379>		02/96-05/06	7SBU16C	R134a	DCP17023	A0002302011
2.9 412 D	OM 602.980	Ch No: 980066379>		02/96-05/06	7SBU16C	R134a	DCP17023	A0002302011
2.9 412 D	OM 602.980	Isotherm vehicle		02/96-05/06	10PA17C	R134a	DCP17020	A0002303711
2.9 412 D 4x4	OM 602.980			05/97-05/06	10PA17C	R134a	DCP17011	A1191300015
2.9 412 D 4x4	OM 602.980			05/97-05/06	10PA17C	R134a	DCP17020	A0002303711
2.9 412 D 4x4	OM 602.980	Ch No: 980066379>		05/97-05/06	7SBU16C	R134a	DCP17023	A0002302011
<b>SPRINTER 5-t (905) (01-)</b>								
2.7 616 CDI	OM 612.981			04/01-02/06	7SBU16C	R134a	DCP17023	A0002302011; A0002307011
2.7 616 CDI	OM 612.981			04/01-02/06	7SBU16C	R134a	DCP17024	A0002306811
2.7 616 CDI	OM 612.981			04/01-02/06	10S17C	R134a	DCP17114	A0002308011
2.7 616 CDI	OM 612.981			04/01-02/06	BODY 7SBU16C	R134a	DCP17B35	A0002343111
<b>SPRINTER 5-t (906) (06-)</b>								
1.8 516	M 271.951			09/08-	7SEU17C	R134a	DCP17072	A0022301911
1.8 516	M 271.951	For vehicles with front and rear A/C		09/08-	7SBU17C	R134a	DCP17151	A0032309011
1.8 516 NGT	M 271.951			09/08-	7SEU17C	R134a	DCP17072	A0022301911
1.8 516 NGT	M 271.951	For vehicles with front and rear A/C		09/08-	7SBU17C	R134a	DCP17151	A0032309011
2.1 509 CDI	OM 646.984			06/06-12/09	7SEU17C	R134a	DCP17072	A0022301911
2.1 509 CDI	OM 646.984	For vehicles with front and rear A/C		06/06-12/09	7SBU17C	R134a	DCP17151	A0032309011
2.1 509 CDI	OM 646.984	Heavy duty version		06/06-12/09	10S17C	R134a	DCP17150	0012307011





				TYPE	GAS	DENSO PN	OE	
<b>MERCEDES-BENZ</b> <i>Continued</i>								
<b>SPRINTER 5-t (906) (06-)</b> <i>Continued</i>								
2.1 510 CDI	OM 651.955			03/09-	7SEU17C	R134a	DCP17072	A0022301911
2.1 510 CDI	OM 651.955	For vehicles with front and rear A/C		03/09-	7SBU17C	R134a	DCP17151	A0032309011
2.1 511 CDI	OM 646.985			06/06-12/09	7SEU17C	R134a	DCP17072	A0022301911
2.1 511 CDI	OM 646.985	For vehicles with front and rear A/C		06/06-12/09	7SBU17C	R134a	DCP17151	A0032309011
2.1 511 CDI	OM 646.985	Heavy duty version		06/06-12/09	10S17C	R134a	DCP17150	0012307011
2.1 511 CDI 4x4	OM 646.985			06/06-12/09	7SEU17C	R134a	DCP17072	A0022301911
2.1 511 CDI 4x4	OM 646.985	For vehicles with front and rear A/C		06/06-12/09	7SBU17C	R134a	DCP17151	A0032309011
2.1 513 CDI	OM 651.955			06/06-	7SEU17C	R134a	DCP17072	A0022301911
2.1 513 CDI	OM 651.955	For vehicles with front and rear A/C		06/06-	7SBU17C	R134a	DCP17151	A0032309011
2.1 513 CDI	OM 651.955;OM 651.957			06/06-	7SEU17C	R134a	DCP17072	A0022301911
2.1 513 CDI	OM 651.955;OM 651.957	For vehicles with front and rear A/C		06/06-	7SBU17C	R134a	DCP17151	A0032309011
2.1 513 CDI	OM 646.986			06/06-	7SEU17C	R134a	DCP17072	A0022301911
2.1 513 CDI	OM 646.986	For vehicles with front and rear A/C		06/06-	7SBU17C	R134a	DCP17151	A0032309011
2.1 513 CDI 4x4	OM 651.955;OM 651.957			06/06-	7SEU17C	R134a	DCP17072	A0022301911
2.1 513 CDI 4x4	OM 651.955;OM 651.957	For vehicles with front and rear A/C		06/06-	7SBU17C	R134a	DCP17151	A0032309011
2.1 515 CDI	OM 646.986;OM 646.989;OM 646.990			06/06-12/09	7SEU17C	R134a	DCP17072	A0022301911
2.1 515 CDI	OM 646.986;OM 646.989;OM 646.990	For vehicles with front and rear A/C		06/06-12/09	7SBU17C	R134a	DCP17151	A0032309011
2.1 515 CDI 4x4	OM 646.986;OM 646.989;OM 646.990			06/06-12/09	7SEU17C	R134a	DCP17072	A0022301911
2.1 515 CDI 4x4	OM 646.986;OM 646.989;OM 646.990	For vehicles with front and rear A/C		06/06-12/09	7SBU17C	R134a	DCP17151	A0032309011
2.1 516 CDI	OM 651.955;OM 651.957			03/09-	7SEU17C	R134a	DCP17072	A0022301911
2.1 516 CDI	OM 651.955;OM 651.957	For vehicles with front and rear A/C		03/09-	7SBU17C	R134a	DCP17151	A0032309011
2.1 516 CDI 4x4	OM 651.955;OM 651.957			06/06-	7SEU17C	R134a	DCP17072	A0022301911
2.1 516 CDI 4x4	OM 651.955;OM 651.957	For vehicles with front and rear A/C		06/06-	7SBU17C	R134a	DCP17151	A0032309011
3.0 518 CDI	OM 642.896; OM 642.986; OM 642.992; OM 642.993			06/06-12/09	10S17C	R134a	DCP17122	A0012307111
3.0 518 CDI	OM 642.896;OM 642.986;OM 642.992; OM 642.993			06/06-12/09	7SEU17C	R134a	DCP17072	A0022301911
3.0 518 CDI	OM 642.896;OM 642.986;OM 642.992; OM 642.993	For vehicles with front and rear A/C		06/06-12/09	7SBU17C	R134a	DCP17151	A0032309011
3.0 518 CDI 4x4	OM 642.896;OM 642.986;OM 642.992; OM 642.993			06/06-12/09	7SEU17C	R134a	DCP17072	A0022301911
3.0 518 CDI 4x4	OM 642.896;OM 642.986;OM 642.992; OM 642.993	For vehicles with front and rear A/C		06/06-12/09	7SBU17C	R134a	DCP17151	A0032309011
3.0 519 CDI / BlueTEC	OM 642.896;OM 642.898;OM 642.986; OM 642.992			03/09-	7SEU17C	R134a	DCP17072	A0022301911
3.0 519 CDI / BlueTEC	OM 642.896;OM 642.898;OM 642.986; OM 642.992	For vehicles with front and rear A/C		03/09-	7SBU17C	R134a	DCP17151	A0032309011
3.0 519 CDI / BlueTEC 4x4	OM 642.896;OM 642.898;OM 642.986; OM 642.992			03/09-	7SEU17C	R134a	DCP17072	A0022301911
3.0 519 CDI / BlueTEC 4x4	OM 642.896;OM 642.898;OM 642.986; OM 642.992	For vehicles with front and rear A/C		03/09-	7SBU17C	R134a	DCP17151	A0032309011
3.5 524	M 272.979			06/06-12/13	7SEU17C	R134a	DCP17072	A0022301911
3.5 524	M 272.979	For vehicles with front and rear A/C		06/06-12/13	7SBU17C	R134a	DCP17151	A0032309011
<b>SPRINTER Classic (909) (13-)</b>								
2.1 411 CDI	OM 646.701	Heavy duty version		09/13-	10S17C	R134a	DCP17150	
<b>T1 (601) (77-96)</b>								
2.3 210	M 102.945			05/89-01/90	10P15C	R134a	DCP17001	A0002302411
2.3 210	M 102.945	Ch No: 012131>		05/89-01/90	10PA15C	R134a	DCP17012	A1021310001
2.3 D 208	OM 601.940			10/88-02/96	10PA15C	R134a	DCP17012	
2.9 D 210	OM 602.940			10/88-02/96	10PA15C	R134a	DCP17012	





				TYPE	GAS	DENSO PN	OE
<b>MERCEDES-BENZ</b> <i>Continued</i>							
<b>T1 (602) (77-96)</b>							
2.3 D 308	OM 601.940		11/88-02/96	10PA15C	R134a	DCP17012	
2.9 D 310	OM 602.940		06/89-02/96	10PA15C	R134a	DCP17012	
<b>T1 / TN (611) (81-95)</b>							
2.9 410 D	OM 602.940		11/88-06/95	10PA15C	R134a	DCP17012	
<b>VANEO (414) (02-05)</b>							
1.6	M 166.961		02/02-07/05	6SEU14C	R134a	DCP17050	
1.7 CDI	OM 668.914		02/02-07/05	6SEU14C	R134a	DCP17050	
1.9	M 166.991		02/02-07/05	6SEU14C	R134a	DCP17050	
<b>V-CLASS (638/2) (96-03)</b>							
V 200	M 111.948; M 111.950		02/97-12/02	10PA17C	R134a	DCP17011	A1191300015
V 200	M 111.948; M 111.950		02/97-12/02	7SBU16C	R134a	DCP17024	A0002306811
V 200	M 111.948; M 111.950	Ch No: 016686>	02/97-12/02	7SBU16C	R134a	DCP17023	A0002302011
V 200	M 111.948; M 111.950	Isotherm vehicle	02/97-12/02	10PA17C	R134a	DCP17020	A0002303711
V 200 CDI	OM 611.980		03/99-12/02	7SBU16C	R134a	DCP17024	
V 220 CDI	OM 611.980		03/99-12/02	7SBU16C	R134a	DCP17023	A0002302011
V 220 CDI	OM 611.980		03/99-12/02	7SBU16C	R134a	DCP17024	A0002306811
V 230	M 111.978; M 111.980		10/96-12/02	10PA17C	R134a	DCP17011	A1191300015
V 230	M 111.978; M 111.980		10/96-12/02	7SBU16C	R134a	DCP17024	A0002306811
V 230	M 111.978; M 111.980	Ch No: 016686>	10/96-12/02	7SBU16C	R134a	DCP17023	A0002302011
V 230	M 111.978; M 111.980	Isotherm vehicle	10/96-12/02	10PA17C	R134a	DCP17020	A0002303711
V 230 TD	OM 601.970		09/96-12/02	10PA17C	R134a	DCP17011	A1191300015
V 230 TD	OM 601.970	Ch No: 016691>	09/96-12/02	7SBU16C	R134a	DCP17023	A0002302011
V 230 TD	OM 601.970	Isotherm vehicle	09/96-12/02	10PA17C	R134a	DCP17020	A0002303711
<b>VIANO (W639) (03-)</b>							
2.0 CDI	OM 646.982		08/05-	7SEU17C	R134a	DCP17109	
2.0 CDI 4-matic	OM 646.982		07/05-	7SEU17C	R134a	DCP17072	
2.0 CDI 4-matic	OM 646.982		03/06-	7SEU17C	R134a	DCP17026	A0012301711
2.2 CDI	OM 646.980; OM 646.982		09/03-	7SEU17C	R134a	DCP17109	
2.2 CDI 4-matic	OM 646.982		07/05-	7SEU17C	R134a	DCP17109	
3.0	M 112.951		09/03-	7SEU17C	R134a	DCP17039	
3.0 CDI	OM 642.890; OM 642.990		03/06-	7SEU17C	R134a	DCP17102	
3.0 CDI	OM 642.890; OM 642.990	All Climate zones	03/06-	7SEU17C	R134a	DCP17090	
3.2	M 112.951		09/03-	7SEU17C	R134a	DCP17039	
3.5	M 272.978		09/07-	7SEU17C	R134a	DCP17026	
3.7	M 112.976		06/04-	7SEU17C	R134a	DCP17039	
<b>VITO (638) (96-03)</b>							
2.0 113	M 111.948; M 111.950		02/96-07/03	10PA17C	R134a	DCP17011	A1191300015
2.0 113	M 111.948; M 111.950		02/96-07/03	7SBU16C	R134a	DCP17024	A0002306811
2.0 113	M 111.948; M 111.950	Ch No: 016686>	02/96-07/03	7SBU16C	R134a	DCP17023	A0002302011
2.0 113	M 111.948; M 111.950	Isotherm vehicle	02/96-07/03	10PA17C	R134a	DCP17020	A0002303711
2.1 108 CDI	OM 611A (60 KW CDI)		03/99-07/03	7SBU16C	R134a	DCP17023	A0002302011
2.1 108 CDI	OM 611A (60 KW CDI)		03/99-07/03	7SBU16C	R134a	DCP17024	A0002306811
2.1 110 CDI	OM 611LA (75 KW CDI)		03/99-07/03	7SBU16C	R134a	DCP17023	A0002302011
2.1 110 CDI	OM 611LA (75 KW CDI)		03/99-07/03	7SBU16C	R134a	DCP17024	A0002306811
2.2 108 CDI	OM 611A (60 KW CDI)		03/99-07/03	7SBU16C	R134a	DCP17023	A0002302011
2.2 108 CDI	OM 611A (60 KW CDI)		03/99-07/03	7SBU16C	R134a	DCP17024	A0002306811
2.2 110 CDI	OM 611LA (75 KW CDI)		03/99-07/03	7SBU16C	R134a	DCP17023	A0002302011
2.2 110 CDI	OM 611LA (75 KW CDI)		03/99-07/03	7SBU16C	R134a	DCP17024	A0002306811
2.2 112 CDI	OM 611.980		03/99-07/03	7SBU16C	R134a	DCP17023	A0002302011
2.2 112 CDI	OM 611.980		03/99-07/03	7SBU16C	R134a	DCP17024	A0002306811
2.3 108 D	OM 601.942		02/96-07/03	10PA17C	R134a	DCP17011	A1191300015
2.3 108 D	OM 601.942	Ch No: 016691>	02/96-07/03	7SBU16C	R134a	DCP17023	A0002302011
2.3 108 D	OM 601.942	Isotherm vehicle	02/96-07/03	10PA17C	R134a	DCP17020	A0002303711
2.3 110 D	OM 601.970		03/97-07/03	10PA17C	R134a	DCP17011	A1191300015
2.3 110 D	OM 601.970	Ch No: 016691>	03/97-07/03	7SBU16C	R134a	DCP17023	A0002302011
2.3 110 D	OM 601.970	Isotherm vehicle	03/97-07/03	10PA17C	R134a	DCP17020	A0002303711
2.3 110 TD	OM 601.970		02/96-07/03	10PA17C	R134a	DCP17011	A1191300015
2.3 110 TD	OM 601.970	Ch No: 016691>	02/96-07/03	7SBU16C	R134a	DCP17023	A0002302011





				TYPE	GAS	DENSO PN	OE
<b>MERCEDES-BENZ</b> <i>Continued</i>							
<b>VITO (638) (96-03)</b> <i>Continued</i>							
2.3 110 TD	OM 601.970	Isotherm vehicle	02/96-07/03	10PA17C	R134a	DCP17020	A0002303711
2.3 114	M 111.978;M 111.980		12/96-07/03	10PA17C	R134a	DCP17011	A1191300015
2.3 114	M 111.978;M 111.980		12/96-07/03	7SBU16C	R134a	DCP17023	A0002302011
2.3 114	M 111.978;M 111.980		12/96-07/03	7SBU16C	R134a	DCP17024	A0002306811
2.3 114	M 111.978;M 111.980	Isotherm vehicle	12/96-07/03	10PA17C	R134a	DCP17020	A0002303711
<b>VITO (W447) (14-)</b>							
1.6 109 CDI / BlueTEC	OM 622.951		10/14-	6SEL14C	R134a	DCP17171	
1.6 111 CDI / BlueTEC	OM 622.951		10/14-	6SEL14C	R134a	DCP17171	
<b>VITO / MIXTO (W639) (03-)</b>							
2.1 109 CDI	OM 646.980;OM 646.981		08/06-	7SEU17C	R134a	DCP17109	
2.1 109 CDI	OM 646.983		09/03-	7SEU17C	R134a	DCP17026	
2.1 109 CDI	OM 646.983		09/03-	7SEU17C	R134a	DCP17040	A0012301411
2.1 109 CDI	OM 646.983	All Climate zones	09/03-	7SEU17C	R134a	DCP17119	
2.1 109 CDI 4x4	OM 646.981		09/07-	7SEU17C	R134a	DCP17109	
2.1 111 CDI	OM 646.980		09/07-	7SEU17C	R134a	DCP17072	
2.1 111 CDI	OM 646.980;OM 646.982		09/03-	7SEU17C	R134a	DCP17109	A0032302311
2.1 111 CDI 4x4	OM 646.982		09/07-	7SEU17C	R134a	DCP17109	
2.1 115 CDI	OM 646.980;OM 646.982		09/03-	7SEU17C	R134a	DCP17026	
2.1 115 CDI 4x4	OM 646.982		07/06-	7SEU17C	R134a	DCP17026	A0012301111
3.0 120 CDI	OM 642.990		07/06-	7SEU17C	R134a	DCP17102	
3.0 120 CDI	OM 642.990	All Climate zones	07/06-	7SEU17C	R134a	DCP17090	
3.0 122 CDI	OM 642.890		09/10-	7SEU17C	R134a	DCP17102	
3.2 119	M 112.951		09/03-	7SEU17C	R134a	DCP17039	
3.2 122	M 112.951		09/03-01/06	7SEU17C	R134a	DCP17039	
3.5 126	M 272.978		09/07-	7SEU17C	R134a	DCP17026	
3.7 123	M 112.976		06/04-02/09	7SEU17C	R134a	DCP17039	
<b>MERCEDES-BENZ CV</b>							
<b>ACTROS (96-03)</b>							
1831 AK	OM 541.926; OM 541.941		04/97-10/02	7SBU16C	R134a	DCP17035	A5412301311
1831 K	OM 541.920; OM 541.940		04/97-10/02	7SBU16C	R134a	DCP17035	A5412301311
1831 S, 1831 LS	OM 541.920; OM 541.940		04/96-10/02	7SBU16C	R134a	DCP17035	A5412301311
1831, 1831 L	OM 541.920		04/96-10/02	7SBU16C	R134a	DCP17035	A5412301311
1835 AK	OM 541.927; OM 541.943		04/97-10/02	7SBU16C	R134a	DCP17035	A5412301311
1835 K	OM 541.922; OM 541.942		04/97-10/02	7SBU16C	R134a	DCP17035	A5412301311
1835 S, 1835 LS	OM 541.922; OM 541.942		04/96-10/02	7SBU16C	R134a	DCP17035	A5412301311
1835, 1835 L	OM 541.922		04/96-10/02	7SBU16C	R134a	DCP17035	A5412301311
1840 AK	OM 541.924; OM 541.945		04/97-10/02	7SBU16C	R134a	DCP17035	A5412301311
1840 K	OM 541.923; OM 541.944		04/97-10/02	7SBU16C	R134a	DCP17035	A5412301311
1840 S, 1840 LS	OM 541.923; OM 541.944		04/96-10/02	7SBU16C	R134a	DCP17035	A5412301311
1840, 1840 L	OM 541.923		04/96-10/02	7SBU16C	R134a	DCP17035	A5412301311
1843 AK	OM 541.921; OM 541.947		04/97-10/02	7SBU16C	R134a	DCP17035	A5412301311
1843 K	OM 541.925; OM 541.946		04/97-10/02	7SBU16C	R134a	DCP17035	A5412301311
1843 S, 1843 LS	OM 541.925; OM 541.946		04/96-10/02	7SBU16C	R134a	DCP17035	A5412301311
1843, 1843 L	OM 541.925		04/96-10/02	7SBU16C	R134a	DCP17035	A5412301311
1848 AK	OM 542.925		04/97-10/02	7SBU16C	R134a	DCP17035	A5412301311
1848 AK	OM 542.925		04/97-10/02	7SBU16C	R134a	DCP17K37	
1848 K	OM 542.921; OM 542.940		04/97-10/02	7SBU16C	R134a	DCP17035	A5412301311
1848 K	OM 542.921; OM 542.940		04/97-10/02	7SBU16C	R134a	DCP17K37	
1848 S, 1848 LS	OM 542.921; OM 542.940		04/96-10/02	7SBU16C	R134a	DCP17035	A5412301311
1848 S, 1848 LS	OM 542.921; OM 542.940		04/96-10/02	7SBU16C	R134a	DCP17K37	
1848, 1848 L	OM 542.921		04/96-10/02	7SBU16C	R134a	DCP17035	A5412301311
1848, 1848 L	OM 542.921		04/96-10/02	7SBU16C	R134a	DCP17K37	
1853 S, 1853 LS	OM 542.920; OM 542.942		04/96-10/02	7SBU16C	R134a	DCP17035	A5412301311
1853 S, 1853 LS	OM 542.920; OM 542.942		04/96-10/02	7SBU16C	R134a	DCP17K37	
1853, 1853 L	OM 542.920		04/96-10/02	7SBU16C	R134a	DCP17035	A5412301311
1853, 1853 L	OM 542.920		04/96-10/02	7SBU16C	R134a	DCP17K37	
1857 L	OM 542.922		04/97-10/02	7SBU16C	R134a	DCP17035	A5412301311
1857 L	OM 542.922		04/97-10/02	7SBU16C	R134a	DCP17K37	
1857 LS	OM 542.922; OM 542.944		04/97-10/02	7SBU16C	R134a	DCP17035	A5412301311
1857 LS	OM 542.922; OM 542.944		04/97-10/02	7SBU16C	R134a	DCP17K37	
2031	OM 541.920		04/97-10/02	7SBU16C	R134a	DCP17035	A5412301311
2031 A	OM 541.926		04/97-10/02	7SBU16C	R134a	DCP17035	A5412301311
2031 AK	OM 541.926; OM 541.941		09/96-10/02	7SBU16C	R134a	DCP17035	A5412301311
2031 AS	OM 541.926; OM 541.941		04/96-10/02	7SBU16C	R134a	DCP17035	A5412301311
2031 K	OM 541.920; OM 541.940		04/97-10/02	7SBU16C	R134a	DCP17035	A5412301311





				TYPE	GAS	DENSO PN	OE
<b>MERCEDES-BENZ CV</b> <i>Continued</i>							
<b>ACTROS (96-03)</b> <i>Continued</i>							
2031 S	OM 541.920; OM 541.940		04/96-10/02	7SBU16C	R134a	DCP17035	A5412301311
2035 A	OM 541.927; OM 541.943		04/97-10/02	7SBU16C	R134a	DCP17035	A5412301311
2035 S	OM 541.922; OM 541.942		04/96-10/02	7SBU16C	R134a	DCP17035	A5412301311
2040	OM 541.923		09/96-10/02	7SBU16C	R134a	DCP17035	A5412301311
2040 AK	OM 541.924; OM 541.945		09/96-10/02	7SBU16C	R134a	DCP17035	A5412301311
2040 AS	OM 541.924; OM 541.945		04/96-10/02	7SBU16C	R134a	DCP17035	A5412301311
2040 S	OM 541.923; OM 541.944		04/96-10/02	7SBU16C	R134a	DCP17035	A5412301311
2043 AS	OM 541.921; OM 541.925; OM 541.947		04/96-10/02	7SBU16C	R134a	DCP17035	A5412301311
2046 AS	OM 541.949		10/96-10/03	7SBU16C	R134a	DCP17035	A5412301311
2048 AS	OM 542.925		04/96-10/02	7SBU16C	R134a	DCP17K37	
2053 S	OM 542.920; OM 542.942		04/96-10/02	7SBU16C	R134a	DCP17035	A5412301311
2053 S	OM 542.920; OM 542.942		04/96-10/02	7SBU16C	R134a	DCP17K37	
2531 LS	OM 541.920; OM 541.940		09/96-10/02	7SBU16C	R134a	DCP17035	A5412301311
2531, 2531 L	OM 541.920; OM 541.940		09/96-10/02	7SBU16C	R134a	DCP17035	A5412301311
2535 L	OM 541.922; OM 541.942		09/96-10/02	7SBU16C	R134a	DCP17035	A5412301311
2535 LS	OM 541.922; OM 541.942		09/96-10/02	7SBU16C	R134a	DCP17035	A5412301311
2540 LS	OM 541.923; OM 541.944		09/96-10/02	7SBU16C	R134a	DCP17035	A5412301311
2540, 2540 L	OM 541.923; OM 541.944		09/96-10/02	7SBU16C	R134a	DCP17035	A5412301311
2543 LS	OM 541.925; OM 541.946		09/96-10/02	7SBU16C	R134a	DCP17035	A5412301311
2543, 2543 L	OM 541.925; OM 541.946		09/96-10/02	7SBU16C	R134a	DCP17035	A5412301311
2548 LS	OM 542.921; OM 542.940		09/96-10/02	7SBU16C	R134a	DCP17035	A5412301311
2548 LS	OM 542.921; OM 542.940		09/96-10/02	7SBU16C	R134a	DCP17K37	
2548, 2548 L	OM 542.921		09/96-10/02	7SBU16C	R134a	DCP17035	A5412301311
2548, 2548 L	OM 542.921		09/96-10/02	7SBU16C	R134a	DCP17K37	
2553 LS	OM 542.920; OM 542.942		09/96-10/02	7SBU16C	R134a	DCP17035	A5412301311
2553 LS	OM 542.920; OM 542.942		09/96-10/02	7SBU16C	R134a	DCP17K37	
2553, 2553 L	OM 542.920		09/96-10/02	7SBU16C	R134a	DCP17035	A5412301311
2553, 2553 L	OM 542.920		09/96-10/02	7SBU16C	R134a	DCP17K37	
2557 L	OM 542.922		09/96-10/02	7SBU16C	R134a	DCP17035	A5412301311
2557 L	OM 542.922		09/96-10/02	7SBU16C	R134a	DCP17K37	
2631 B	OM 541.920; OM 541.940		04/97-10/02	7SBU16C	R134a	DCP17035	A5412301311
2631 K	OM 541.920; OM 541.940		04/97-10/02	7SBU16C	R134a	DCP17035	A5412301311
2631, 2631 L	OM 541.920		04/96-10/02	7SBU16C	R134a	DCP17035	A5412301311
2635 B	OM 541.922; OM 541.942		04/97-10/02	7SBU16C	R134a	DCP17035	A5412301311
2635 K, 2635 LK	OM 541.922; OM 541.942		04/97-10/02	7SBU16C	R134a	DCP17035	A5412301311
2635, 2635 L	OM 541.922		04/96-10/02	7SBU16C	R134a	DCP17035	A5412301311
2640 B	OM 541.923; OM 541.944		04/97-10/02	7SBU16C	R134a	DCP17035	A5412301311
2640 K, 2640 LK	OM 541.923; OM 541.944		04/97-10/02	7SBU16C	R134a	DCP17035	A5412301311
2640 S, 2640 LS	OM 541.923; OM 541.944		09/96-10/02	7SBU16C	R134a	DCP17035	A5412301311
2640, 2640 L	OM 541.923		04/96-10/02	7SBU16C	R134a	DCP17035	A5412301311
2643 B	OM 541.925; OM 541.946		04/97-10/02	7SBU16C	R134a	DCP17036	
2643 K, 2643 LK	OM 541.925; OM 541.946		04/97-10/02	7SBU16C	R134a	DCP17036	
2643 S, 2643 LS	OM 541.925; OM 541.946		04/97-10/02	7SBU16C	R134a	DCP17036	
2643, 2643 L	OM 541.925		04/96-10/02	7SBU16C	R134a	DCP17036	
2648 K, 2648 LK	OM 541.948		10/97-10/03	7SBU16C	R134a	DCP17035	A5412301311
2648 K, 2648 LK	OM 542.921; OM 542.940		04/97-10/02	7SBU16C	R134a	DCP17035	A5412301311
2648 K, 2648 LK	OM 542.921; OM 542.940		04/97-10/02	7SBU16C	R134a	DCP17K37	
2648 S, 2648 LS	OM 542.921; OM 542.940		09/96-10/02	7SBU16C	R134a	DCP17035	A5412301311
2648 S, 2648 LS	OM 542.921; OM 542.940		09/96-10/02	7SBU16C	R134a	DCP17K37	
2648, 2648 L	OM 542.921		04/96-10/02	7SBU16C	R134a	DCP17035	A5412301311
2648, 2648 L	OM 542.921		04/96-10/02	7SBU16C	R134a	DCP17K37	
2653 K, 2653 LK	OM 542.920; OM 542.942		04/97-10/02	7SBU16C	R134a	DCP17035	A5412301311
2653 K, 2653 LK	OM 542.920; OM 542.942		04/97-10/02	7SBU16C	R134a	DCP17K37	
2653 S, 2653 LS	OM 542.920; OM 542.942		09/96-10/02	7SBU16C	R134a	DCP17035	A5412301311
2653 S, 2653 LS	OM 542.920; OM 542.942		09/96-10/02	7SBU16C	R134a	DCP17K37	
2653, 2653 L	OM 542.920		04/96-10/02	7SBU16C	R134a	DCP17035	A5412301311
2653, 2653 L	OM 542.920		04/96-10/02	7SBU16C	R134a	DCP17K37	
2657 K, 2657 LK	OM 542.922; OM 542.944		04/97-10/02	7SBU16C	R134a	DCP17035	A5412301311
2657 K, 2657 LK	OM 542.922; OM 542.944		04/97-10/02	7SBU16C	R134a	DCP17K37	
2657 L	OM 542.922		04/97-10/02	7SBU16C	R134a	DCP17035	A5412301311
2657 L	OM 542.922		04/97-10/02	7SBU16C	R134a	DCP17K37	
2657 S, 2657 LS	OM 542.922; OM 542.944		04/97-10/02	7SBU16C	R134a	DCP17035	A5412301311
2657 S, 2657 LS	OM 542.922; OM 542.944		04/97-10/02	7SBU16C	R134a	DCP17K37	
3231 B	OM 541.920; OM 541.940		04/97-10/02	7SBU16C	R134a	DCP17035	A5412301311
3231 K	OM 541.920; OM 541.940		04/97-10/02	7SBU16C	R134a	DCP17035	A5412301311
3235	OM 541.922; OM 541.942		04/97-10/02	7SBU16C	R134a	DCP17035	A5412301311
3235 B	OM 541.922; OM 541.942		04/97-10/02	7SBU16C	R134a	DCP17035	A5412301311
3235 K	OM 541.922; OM 541.942		04/97-10/02	7SBU16C	R134a	DCP17035	A5412301311











				TYPE	GAS	DENSO PN	OE
<b>MERCEDES-BENZ CV</b> <i>Continued</i>							
<b>ACTROS (96-03)</b> <i>Continued</i>							
3240	OM 541.923; OM 541.944		04/97-10/02	7SBU16C	R134a	DCP17035	A5412301311
3240 B	OM 541.923; OM 541.944		04/97-10/02	7SBU16C	R134a	DCP17035	A5412301311
3240 K	OM 541.923; OM 541.944		04/97-10/02	7SBU16C	R134a	DCP17035	A5412301311
3243	OM 541.925; OM 541.946		04/97-10/02	7SBU16C	R134a	DCP17035	A5412301311
3243 B	OM 541.925; OM 541.946		04/97-10/02	7SBU16C	R134a	DCP17036	
3243 K	OM 541.925; OM 541.946		04/97-10/02	7SBU16C	R134a	DCP17036	
3331	OM 541.920		04/97-10/02	7SBU16C	R134a	DCP17035	A5412301311
3331 A	OM 541.926		04/97-10/02	7SBU16C	R134a	DCP17035	A5412301311
3331 AK	OM 541.926; OM 541.941		04/97-10/02	7SBU16C	R134a	DCP17035	A5412301311
3331 AS	OM 541.926; OM 541.941		04/97-10/02	7SBU16C	R134a	DCP17035	A5412301311
3331 B	OM 541.920; OM 541.940		04/97-10/02	7SBU16C	R134a	DCP17035	A5412301311
3331 K	OM 541.920; OM 541.940		04/97-10/02	7SBU16C	R134a	DCP17035	A5412301311
3331 S	OM 541.920; OM 541.940		04/97-10/02	7SBU16C	R134a	DCP17035	A5412301311
3335	OM 541.922		04/97-10/02	7SBU16C	R134a	DCP17035	A5412301311
3335 B	OM 541.922; OM 541.942		04/97-10/02	7SBU16C	R134a	DCP17035	A5412301311
3335 K	OM 541.922; OM 541.942		04/97-10/02	7SBU16C	R134a	DCP17035	A5412301311
3335 S	OM 541.922		04/97-10/02	7SBU16C	R134a	DCP17036	
3340	OM 541.923		04/97-10/02	7SBU16C	R134a	DCP17035	A5412301311
3340 A	OM 541.924		04/97-10/02	7SBU16C	R134a	DCP17035	A5412301311
3340 AK	OM 541.924; OM 541.945		04/97-10/02	7SBU16C	R134a	DCP17035	A5412301311
3340 AS	OM 541.924; OM 541.945		04/97-10/02	7SBU16C	R134a	DCP17035	A5412301311
3340 B	OM 541.923; OM 541.944		04/97-10/02	7SBU16C	R134a	DCP17036	
3340 K	OM 541.923; OM 541.944		04/97-10/02	7SBU16C	R134a	DCP17035	A5412301311
3340 S	OM 541.923		04/97-10/02	7SBU16C	R134a	DCP17035	A5412301311
3343	OM 541.925		04/97-10/02	7SBU16C	R134a	DCP17035	A5412301311
3343 AK	OM 541.921; OM 541.947		04/97-10/02	7SBU16C	R134a	DCP17035	A5412301311
3343 AS	OM 541.921; OM 541.947		04/97-10/02	7SBU16C	R134a	DCP17035	A5412301311
3343 B	OM 541.925		04/97-10/02	7SBU16C	R134a	DCP17035	A5412301311
3343 K	OM 541.925; OM 541.946		04/97-10/02	7SBU16C	R134a	DCP17035	A5412301311
3343 S	OM 541.925; OM 541.946		04/97-10/02	7SBU16C	R134a	DCP17035	A5412301311
3346	OM 541.948		04/97-10/02	7SBU16C	R134a	DCP17035	A5412301311
3348	OM 542.921		04/97-10/02	7SBU16C	R134a	DCP17035	A5412301311
3348	OM 542.921		04/97-10/02	7SBU16C	R134a	DCP17K37	
3348 AK	OM 542.925		04/97-10/02	7SBU16C	R134a	DCP17035	A5412301311
3348 AK	OM 542.925		04/97-10/02	7SBU16C	R134a	DCP17K37	
3348 AS	OM 542.925		04/97-10/02	7SBU16C	R134a	DCP17035	A5412301311
3348 AS	OM 542.925		04/97-10/02	7SBU16C	R134a	DCP17K37	
3348 K	OM 542.921; OM 542.940		04/97-10/02	7SBU16C	R134a	DCP17035	A5412301311
3348 K	OM 542.921; OM 542.940		04/97-10/02	7SBU16C	R134a	DCP17K37	
3348 S	OM 542.921		04/97-10/02	7SBU16C	R134a	DCP17035	A5412301311
3348 S	OM 542.921		04/97-10/02	7SBU16C	R134a	DCP17K37	
3353	OM 542.920		04/97-10/02	7SBU16C	R134a	DCP17035	A5412301311
3353	OM 542.920		04/97-10/02	7SBU16C	R134a	DCP17K37	
3353 AS	OM 542.920; OM 542.926; OM 542.943		04/97-10/02	7SBU16C	R134a	DCP17035	A5412301311
3353 AS	OM 542.920; OM 542.926; OM 542.943		04/97-10/02	7SBU16C	R134a	DCP17K37	
3353 S	OM 542.920; OM 542.942		04/97-10/02	7SBU16C	R134a	DCP17035	A5412301311
3353 S	OM 542.920; OM 542.942		04/97-10/02	7SBU16C	R134a	DCP17K37	
3357	OM 542.922		04/97-10/02	7SBU16C	R134a	DCP17035	A5412301311
3357	OM 542.922		04/97-10/02	7SBU16C	R134a	DCP17K37	
3357 S	OM 542.922; OM 542.944		04/97-10/02	7SBU16C	R134a	DCP17035	A5412301311
3357 S	OM 542.922; OM 542.944		04/97-10/02	7SBU16C	R134a	DCP17K37	
4140 AK	OM 541.924; OM 541.945		04/97-10/02	7SBU16C	R134a	DCP17035	A5412301311
4140 B	OM 541.923; OM 541.944		04/97-10/02	7SBU16C	R134a	DCP17035	A5412301311
4140 K	OM 541.923; OM 541.944		04/97-10/02	7SBU16C	R134a	DCP17035	A5412301311
4140 K	OM 541.924; OM 541.945		04/97-10/02	7SBU16C	R134a	DCP17036	
4143 AK	OM 541.921; OM 541.947		04/97-10/02	7SBU16C	R134a	DCP17035	A5412301311
4143 K	OM 541.921; OM 541.947		04/97-10/02	7SBU16C	R134a	DCP17036	
4143 K	OM 541.925; OM 541.946		04/97-10/02	7SBU16C	R134a	DCP17035	A5412301311
4148 AK	OM 542.925		04/97-10/02	7SBU16C	R134a	DCP17035	A5412301311
4148 AK	OM 542.925		04/97-10/02	7SBU16C	R134a	DCP17K37	
4148 K	OM 542.921; OM 542.925		04/97-10/02	7SBU16C	R134a	DCP17035	A5412301311
4148 K	OM 542.921; OM 542.925		04/97-10/02	7SBU16C	R134a	DCP17K37	
<b>ACTROS MP2 / MP3 (02-)</b>							
1831 AK	OM 541.926; OM 541.941		04/03-	7SBU16C	R134a	DCP17036	A5412301211
1831 K	OM 541.920; OM 541.940		04/03-	7SBU16C	R134a	DCP17036	A5412301211
1832 AK	OM 541.940; OM 541.971; OM 541.997		04/03-	7SBU16C	R134a	DCP17035	A5412301311
1832 AK	OM 541.940; OM 541.971; OM 541.997		04/03-	7SBU16C	R134a	DCP17036	A5412301211
1832 K	OM 541.940; OM 541.970; OM 541.996		04/03-	7SBU16C	R134a	DCP17035	A5412301311





				TYPE	GAS	DENSO PN	OE
<b>MERCEDES-BENZ CV</b> <i>Continued</i>							
<b>ACTROS MP2 / MP3 (02-)</b> <i>Continued</i>							
1832 K	OM 541.940; OM 541.970; OM 541.996		04/03-	7SBU16C	R134a	DCP17036	A5412301211
1832, L, LL	OM 541.940; OM 541.970		04/03-	7SBU16C	R134a	DCP17035	A5412301311
1832, L, LL	OM 541.940; OM 541.970		04/03-	7SBU16C	R134a	DCP17036	A5412301211
1835 AK	OM 541.927; OM 541.943		04/03-	7SBU16C	R134a	DCP17036	A5412301211
1835 K	OM 541.922; OM 541.942		04/03-	7SBU16C	R134a	DCP17036	A5412301211
1836 AK	OM 541.942; OM 541.999		04/03-	7SBU16C	R134a	DCP17035	A5412301311
1836 K	OM 541.942; OM 541.972; OM 541.998		04/03-	7SBU16C	R134a	DCP17035	A5412301311
1836 LS, LLS	OM 541.942		04/03-	7SBU16C	R134a	DCP17035	A5412301311
1836 LS, LLS	OM 541.942		04/03-	7SBU16C	R134a	DCP17036	A5412301211
1836, L, LL	OM 541.942		04/03-	7SBU16C	R134a	DCP17035	A5412301311
1836, L, LL	OM 541.942		04/03-	7SBU16C	R134a	DCP17036	A5412301211
1841 K	OM 541.944; OM 541.974; OM 541.990		04/03-	7SBU16C	R134a	DCP17035	A5412301311
1841 LS, LLS	OM 541.944; OM 541.974; OM 541.990		04/03-	7SBU16C	R134a	DCP17035	A5412301311
1841, L, LL	OM 541.944; OM 541.974; OM 541.990		04/03-	7SBU16C	R134a	DCP17035	A5412301311
1844 LS, LLS	OM 541.946; OM 541.976; OM 541.992		04/03-	7SBU16C	R134a	DCP17035	A5412301311
1844, L, LL	OM 541.946; OM 541.976; OM 541.992		04/03-	7SBU16C	R134a	DCP17035	A5412301311
1846 AK	OM 541.948; OM 541.949; OM 541.981; OM 541.995		04/03-	7SBU16C	R134a	DCP17035	A5412301311
1846 K	OM 541.948; OM 541.980; OM 541.994		04/03-	7SBU16C	R134a	DCP17035	A5412301311
1846 LS, LLS	OM 541.948; OM 541.980		04/03-	7SBU16C	R134a	DCP17035	A5412301311
1846, L, LL	OM 541.948; OM 541.980		04/03-	7SBU16C	R134a	DCP17035	A5412301311
1848 AK	OM 542.925		04/03-	7SBU16C	R134a	DCP17K37	
1848 K	OM 542.921; OM 542.940		04/03-	7SBU16C	R134a	DCP17K37	
1848 S, LS	OM 542.921		04/03-	7SBU16C	R134a	DCP17K37	
1848, L, LL	OM 542.921		04/03-	7SBU16C	R134a	DCP17K37	
1850 AK, 1851 AK	OM 542.940; OM 542.941; OM 542.960; OM 542.961		04/03-	7SBU16C	R134a	DCP17035	A5412301311
1850, 1851 K	OM 542.940; OM 542.960		04/03-	7SBU16C	R134a	DCP17035	A5412301311
1850, 1851 LS, LLS	OM 542.940; OM 542.960		04/03-	7SBU16C	R134a	DCP17035	A5412301311
1850, 1851, L, LL	OM 542.940; OM 542.960		04/03-	7SBU16C	R134a	DCP17035	A5412301311
1854 LS	OM 542.942		04/03-	7SBU16C	R134a	DCP17035	A5412301311
1854 LS	OM 542.942		04/03-	7SBU16C	R134a	DCP17K37	
1854, L	OM 542.942; OM 542.962		04/03-	7SBU16C	R134a	DCP17035	A5412301311
1854, L	OM 542.942; OM 542.962		04/03-	7SBU16C	R134a	DCP17K37	
1858 LS	OM 542.944		10/02-	7SBU16C	R134a	DCP17035	A5412301311
1858, L	OM 542.944		04/03-	7SBU16C	R134a	DCP17035	A5412301311
1861 LS	OM 542.958		05/05-	7SBU16C	R134a	DCP17K37	
2032	OM 541.920; OM 541.940		04/03-	7SBU16C	R134a	DCP17035	A5412301311
2032 A, AE	OM 541.926; OM 541.940; OM 541.941		04/03-	7SBU16C	R134a	DCP17035	A5412301311
2032 AK	OM 541.920; OM 541.926; OM 541.940; OM 541.941; OM 541.997		04/03-	7SBU16C	R134a	DCP17035	A5412301311
2032 AS	OM 541.926; OM 541.941		04/03-	7SBU16C	R134a	DCP17035	A5412301311
2032 K	OM 541.920; OM 541.940; OM 541.970; OM 541.996		04/03-	7SBU16C	R134a	DCP17035	A5412301311
2032 S	OM 541.920; OM 541.940		04/03-	7SBU16C	R134a	DCP17035	A5412301311
2036	OM 541.922; OM 541.942		04/03-	7SBU16C	R134a	DCP17035	A5412301311
2036 A, AE	OM 541.927; OM 541.942; OM 541.943		04/03-	7SBU16C	R134a	DCP17035	A5412301311
2036 AS	OM 541.927; OM 541.943		04/03-	7SBU16C	R134a	DCP17035	A5412301311
2041	OM 541.944; OM 541.974; OM 541.990		04/03-	7SBU16C	R134a	DCP17035	A5412301311
2041 AK	OM 541.924; OM 541.944; OM 541.945; OM 541.991		04/03-	7SBU16C	R134a	DCP17035	A5412301311
2041 AS	OM 541.924; OM 541.991		04/03-	7SBU16C	R134a	DCP17035	A5412301311
2041 K	OM 541.923; OM 541.944; OM 541.974; OM 541.990		04/03-	7SBU16C	R134a	DCP17035	A5412301311
2041 S	OM 541.923; OM 541.944; OM 541.974; OM 541.990		04/03-	7SBU16C	R134a	DCP17035	A5412301311
2044	OM 541.946; OM 541.976; OM 541.992		04/03-	7SBU16C	R134a	DCP17035	A5412301311
2044 AS	OM 541.921; OM 541.947		04/03-	7SBU16C	R134a	DCP17035	A5412301311
2044 S	OM 541.925; OM 541.946; OM 541.976; OM 541.992		04/03-	7SBU16C	R134a	DCP17035	A5412301311
2046	OM 541.948; OM 541.980		04/03-	7SBU16C	R134a	DCP17035	A5412301311
2046 S	OM 541.948; OM 541.980		04/03-	7SBU16C	R134a	DCP17035	A5412301311
2048 AS	OM 542.925		04/03-	7SBU16C	R134a	DCP17K37	
2050 S	OM 542.940; OM 542.941		04/03-	7SBU16C	R134a	DCP17035	A5412301311
2532 LS			06/08-	7SBU16C	R134a	DCP17035	A5412301311
2536, L, LL	OM 541.922; OM 541.942; OM 541.943; OM 541.972; OM 541.998		04/03-	7SBU16C	R134a	DCP17035	A5412301311
2541, L, LL	OM 541.923; OM 541.944; OM 541.974; OM 541.990		04/03-	7SBU16C	R134a	DCP17035	A5412301311
2544, L, LL	OM 541.925; OM 541.946; OM 541.976; OM 541.992		04/03-	7SBU16C	R134a	DCP17035	A5412301311
2546, L, LL	OM 541.948; OM 541.980; OM 541.994		04/03-	7SBU16C	R134a	DCP17035	A5412301311





				TYPE	GAS	DENSO PN	OE
<b>MERCEDES-BENZ CV</b> <i>Continued</i>							
<b>ACTROS MP2 / MP3 (02-)</b> <i>Continued</i>							
2548 L	OM 542.921; OM 542.940		04/03-	7SBU16C	R134a	DCP17K37	
2553 L	OM 542.920; OM 542.942		04/03-	7SBU16C	R134a	DCP17K37	
2555 LS	OM 542.962		09/05-	7SBU16C	R134a	DCP17K37	
2632 K, LK	OM 541.940; OM 541.970; OM 541.996		04/03-	7SBU16C	R134a	DCP17035	A5412301311
2632, L, LL	OM 541.940; OM 541.970; OM 541.996		04/03-	7SBU16C	R134a	DCP17035	A5412301311
2636 K, LK	OM 541.942; OM 541.972; OM 541.998		04/03-	7SBU16C	R134a	DCP17035	A5412301311
2636 LS	OM 541.942; OM 541.972; OM 541.998		04/03-	7SBU16C	R134a	DCP17035	A5412301311
2636, L, LL	OM 541.942; OM 541.972; OM 541.998		04/03-	7SBU16C	R134a	DCP17035	A5412301311
2641 K, LK	OM 541.944; OM 541.974; OM 541.990		04/03-	7SBU16C	R134a	DCP17035	A5412301311
2644 K, LK	OM 541.946; OM 541.976; OM 541.992		04/03-	7SBU16C	R134a	DCP17035	A5412301311
2644 S, LS	OM 541.925; OM 541.946; OM 541.976; OM 541.992		04/03-	7SBU16C	R134a	DCP17035	A5412301311
2644, L, LL	OM 541.946; OM 541.976; OM 541.992		04/03-	7SBU16C	R134a	DCP17035	A5412301311
2646 K, LK	OM 541.948; OM 541.980; OM 541.994		04/03-	7SBU16C	R134a	DCP17035	A5412301311
2646 S, LS	OM 541.948; OM 541.980; OM 541.994		04/03-	7SBU16C	R134a	DCP17035	A5412301311
2646, L, LL	OM 541.948; OM 541.980; OM 541.994		04/03-	7SBU16C	R134a	DCP17035	A5412301311
2648 K, LK	OM 542.921; OM 542.940		04/03-	7SBU16C	R134a	DCP17K37	
2648 L	OM 542.921; OM 542.940		04/03-	7SBU16C	R134a	DCP17K37	
2648 LS	OM 542.921		10/02-	7SBU16C	R134a	DCP17K37	
2650 K, 2651 K, LK	OM 542.940; OM 542.960		04/03-	7SBU16C	R134a	DCP17035	A5412301311
2650 S, LS	OM 542.940		04/03-	7SBU16C	R134a	DCP17035	A5412301311
2650, L, 2651, L, LL	OM 542.940		04/03-	7SBU16C	R134a	DCP17035	A5412301311
2653 K, LK	OM 542.920; OM 542.942		04/03-	7SBU16C	R134a	DCP17K37	
2653 L	OM 542.920		04/03-	7SBU16C	R134a	DCP17K37	
2653 LS	OM 542.920; OM 542.942		10/09-	7SBU16C	R134a	DCP17K37	
2654 K, LK, 2655 K, LK	OM 542.942; OM 542.962		04/03-	7SBU16C	R134a	DCP17035	A5412301311
2654 K, LK, 2655 K, LK	OM 542.942; OM 542.962		04/03-	7SBU16C	R134a	DCP17K37	
2654 S, LS	OM 542.920; OM 542.942		04/03-	7SBU16C	R134a	DCP17035	A5412301311
2654 S, LS	OM 542.920; OM 542.942		04/03-	7SBU16C	R134a	DCP17K37	
2654, L, 2655, L, LL	OM 542.942; OM 542.962		04/03-	7SBU16C	R134a	DCP17035	A5412301311
2654, L, 2655, L, LL	OM 542.942; OM 542.962		04/03-	7SBU16C	R134a	DCP17K37	
2655 LS	OM 542.962		10/09-	7SBU16C	R134a	DCP17K37	
2655 S, LS	OM 542.962		04/03-	7SBU16C	R134a	DCP17K37	
2658 K, LK	OM 542.944		04/03-	7SBU16C	R134a	DCP17035	A5412301311
2658 L	OM 542.944		04/03-	7SBU16C	R134a	DCP17035	A5412301311
2658 LS	OM 542.944		04/03-	7SBU16C	R134a	DCP17035	A5412301311
3231 K, 3232 K	OM 541.920; OM 541.940; OM 541.970; OM 541.996		04/03-	7SBU16C	R134a	DCP17035	A5412301311
3241	OM 541.944; OM 541.974; OM 541.990		04/03-	7SBU16C	R134a	DCP17035	A5412301311
3255 L	OM 542.962		02/09-	7SBU16C	R134a	DCP17K37	
3331 A, 3332 A	OM 541.920; OM 541.926; OM 541.940; OM 541.941; OM 541.971; OM 541.997		04/03-	7SBU16C	R134a	DCP17035	A5412301311
3331 AK, 3332 AK	OM 541.920; OM 541.926; OM 541.940		04/03-	7SBU16C	R134a	DCP17035	A5412301311
3331 S, 3332 S	OM 541.920; OM 541.940; OM 541.970		04/03-	7SBU16C	R134a	DCP17035	A5412301311
3331, 3332	OM 541.920; OM 541.940		04/03-	7SBU16C	R134a	DCP17035	A5412301311
3332 K	OM 541.920; OM 541.940; OM 541.970; OM 541.996		04/03-	7SBU16C	R134a	DCP17035	A5412301311
3336	OM 541.942; OM 541.972		04/03-	7SBU16C	R134a	DCP17035	A5412301311
3336 A	OM 541.942; OM 541.943; OM 541.973; OM 541.999		04/03-	7SBU16C	R134a	DCP17035	A5412301311
3336 K	OM 541.942		04/03-	7SBU16C	R134a	DCP17035	A5412301311
3336 S	OM 541.942; OM 541.972		04/03-	7SBU16C	R134a	DCP17035	A5412301311
3341	OM 541.944; OM 541.974; OM 541.990		04/03-	7SBU16C	R134a	DCP17035	A5412301311
3341 S	OM 541.923; OM 541.944; OM 541.974; OM 541.990		04/03-	7SBU16C	R134a	DCP17035	A5412301311
3344	OM 541.946; OM 541.947; OM 541.992		04/03-	7SBU16C	R134a	DCP17035	A5412301311
3344 S	OM 541.946; OM 541.976; OM 541.992		04/03-	7SBU16C	R134a	DCP17035	A5412301311
3346	OM 541.948		04/03-	7SBU16C	R134a	DCP17035	A5412301311
3346 S	OM 541.948		04/03-	7SBU16C	R134a	DCP17035	A5412301311
3348	OM 542.921		04/03-	7SBU16C	R134a	DCP17035	A5412301311
3348	OM 542.921		04/03-	7SBU16C	R134a	DCP17K37	
3348 AK	OM 542.925		04/03-	7SBU16C	R134a	DCP17K37	
3348 AS	OM 542.925		04/03-	7SBU16C	R134a	DCP17K37	
3348 K	OM 542.921		04/03-	7SBU16C	R134a	DCP17K37	
3348 S	OM 542.921		04/03-	7SBU16C	R134a	DCP17035	A5412301311
3348 S	OM 542.921		04/03-	7SBU16C	R134a	DCP17K37	
3350, 3351	OM 542.940; OM 542.960		04/03-	7SBU16C	R134a	DCP17035	A5412301311
3351 S	OM 542.940; OM 542.960		04/03-	7SBU16C	R134a	DCP17035	A5412301311
3354, 3355	OM 542.942; OM 542.962		04/03-	7SBU16C	R134a	DCP17035	A5412301311
3354, 3355	OM 542.942; OM 542.962		04/03-	7SBU16C	R134a	DCP17K37	

				TYPE	GAS	DENSO PN	OE
<b>MERCEDES-BENZ CV</b> <i>Continued</i>							
<b>ACTROS MP2 / MP3 (02-)</b> <i>Continued</i>							
3355 A	OM 542.963		04/03-	7SBU16C	R134a	DCP17K37	
3355 AK	OM 542.963		04/03-	7SBU16C	R134a	DCP17K37	
3355 AS	OM 542.963		04/03-	7SBU16C	R134a	DCP17K37	
3355 S	OM 542.962		04/03-	7SBU16C	R134a	DCP17K37	
4140 AK	OM 541.923; OM 541.924; OM 541.944; OM 541.945		04/03-	7SBU16C	R134a	DCP17035	A5412301311
4141 AK	OM 541.991		04/03-	7SBU16C	R134a	DCP17035	A5412301311
4144 K	OM 541.976; OM 541.993		04/03-	7SBU16C	R134a	DCP17035	A5412301311
4148 AK	OM 542.925		04/03-	7SBU16C	R134a	DCP17K37	
4148 K	OM 542.925		04/03-	7SBU16C	R134a	DCP17K37	
4155 AK	OM 542.963		04/03-	7SBU16C	R134a	DCP17K37	
4155 K	OM 542.962		04/03-	7SBU16C	R134a	DCP17K37	
4160 S	OM 542.956; OM 542.957		10/02-	7SBU16C	R134a	DCP17K37	
<b>ACTROS MP4 (11-)</b>							
1824 L	OM 936.912		07/11-	10S15C	R134a	DCP17185	
1824 LS	OM 936.912		07/11-	10S15C	R134a	DCP17185	
1827 L	OM 936.912		07/11-	10S15C	R134a	DCP17185	
1827 LS	OM 936.912		07/11-	10S15C	R134a	DCP17185	
1830 L	OM 936.912		07/11-	10S15C	R134a	DCP17185	
1830 LS	OM 936.912		07/11-	10S15C	R134a	DCP17185	
1832 L	OM 936.916		07/11-	10S15C	R134a	DCP17185	
1832 LS	OM 936.916		07/11-	10S15C	R134a	DCP17185	
1833 L	OM 470.906		07/11-	10S15C	R134a	DCP17186	A4722300111
1833 LS	OM 470.906		07/11-	10S15C	R134a	DCP17186	A4722300111
1835 L	OM 936.916		07/11-	10S15C	R134a	DCP17185	
1835 LS	OM 936.916		07/11-	10S15C	R134a	DCP17185	
1836 L	OM 470.906		07/11-	10S15C	R134a	DCP17186	A4722300111
1836 LS	OM 470.906		07/11-	10S15C	R134a	DCP17186	A4722300111
1840 L	OM 470.906		07/11-	10S15C	R134a	DCP17186	A4722300111
1840 LS	OM 470.906		07/11-	10S15C	R134a	DCP17186	A4722300111
1842 L	OM 471.900; OM 471.909		07/11-	10S15C	R134a	DCP17186	A4722300111
1842 LS	OM 471.900; OM 471.909		07/11-	10S15C	R134a	DCP17186	A4722300111
1843 L	OM 470.906		07/11-	10S15C	R134a	DCP17186	A4722300111
1843 LS	OM 470.906		07/11-	10S15C	R134a	DCP17186	A4722300111
1845 L	OM 471.900; OM 471.909		07/11-	10S15C	R134a	DCP17186	A4722300111
1845 LS	OM 471.900; OM 471.909		07/11-	10S15C	R134a	DCP17186	A4722300111
1848 L	OM 471.900		07/11-	10S15C	R134a	DCP17186	A4722300111
1848 LS	OM 471.900		07/11-	10S15C	R134a	DCP17186	A4722300111
1851 L	OM 471.900; OM 471.909		07/11-	10S15C	R134a	DCP17186	A4722300111
1851 LS	OM 471.900; OM 471.909		07/11-	10S15C	R134a	DCP17186	A4722300111
1852 L	OM 473.900		01/14-	10S15C	R134a	DCP17186	A4722300111
1852 LS	OM 473.900		01/14-	10S15C	R134a	DCP17186	A4722300111
1863 L	OM 473.903		01/14-	10S15C	R134a	DCP17186	A4722300111
1863 LS	OM 473.903		01/14-	10S15C	R134a	DCP17186	A4722300111
2024 L	OM 936.912		07/11-	10S15C	R134a	DCP17185	
2024 LS	OM 936.912		07/11-	10S15C	R134a	DCP17185	
2027 L	OM 936.912		07/11-	10S15C	R134a	DCP17185	
2027 LS	OM 936.912		07/11-	10S15C	R134a	DCP17185	
2030 L	OM 936.912		07/11-	10S15C	R134a	DCP17185	
2030 LS	OM 936.912		07/11-	10S15C	R134a	DCP17185	
2032 L	OM 936.916		07/11-	10S15C	R134a	DCP17185	
2032 LS	OM 936.916		07/11-	10S15C	R134a	DCP17185	
2033 L	OM 470.906		07/11-	10S15C	R134a	DCP17186	A4722300111
2033 LS	OM 470.906		07/11-	10S15C	R134a	DCP17186	A4722300111
2035 L	OM 936.916		07/11-	10S15C	R134a	DCP17185	
2035 LS	OM 936.916		07/11-	10S15C	R134a	DCP17185	
2036 L	OM 470.906		07/11-	10S15C	R134a	DCP17186	A4722300111
2036 LS	OM 470.906		07/11-	10S15C	R134a	DCP17186	A4722300111
2040 L	OM 470.906		07/11-	10S15C	R134a	DCP17186	A4722300111
2040 LS	OM 470.906		07/11-	10S15C	R134a	DCP17186	A4722300111
2042 L	OM 471.900; OM 471.909		07/11-	10S15C	R134a	DCP17186	A4722300111
2042 LS	OM 471.900; OM 471.909		07/11-	10S15C	R134a	DCP17186	A4722300111
2043 L	OM 470.906		07/11-	10S15C	R134a	DCP17186	A4722300111
2043 LS	OM 470.906		07/11-	10S15C	R134a	DCP17186	A4722300111
2045 L	OM 471.900; OM 471.909		07/11-	10S15C	R134a	DCP17186	A4722300111
2045 LS	OM 471.900; OM 471.909		07/11-	10S15C	R134a	DCP17186	A4722300111
2048 L	OM 471.900		07/11-	10S15C	R134a	DCP17186	A4722300111
2048 LS	OM 471.900		07/11-	10S15C	R134a	DCP17186	A4722300111
2051 L	OM 471.900; OM 471.909		07/11-	10S15C	R134a	DCP17186	A4722300111

				TYPE	GAS	DENSO PN	OE
<b>MERCEDES-BENZ CV</b> <i>Continued</i>							
<b>ACTROS MP4 (11-)</b> <i>Continued</i>							
2051 LS	OM 471.900; OM 471.909		07/11-	10S15C	R134a	DCP17186	A4722300111
2427 LS	OM 936.912		07/11-	10S15C	R134a	DCP17185	
2430 LS	OM 936.912		07/11-	10S15C	R134a	DCP17185	
2432 LS	OM 936.916		07/11-	10S15C	R134a	DCP17185	
2433 LS	OM 470.906		07/11-	10S15C	R134a	DCP17186	A4722300111
2435 LS	OM 936.916		07/11-	10S15C	R134a	DCP17185	
2436 LS	OM 470.906		07/11-	10S15C	R134a	DCP17186	A4722300111
2440 LS	OM 470.906		07/11-	10S15C	R134a	DCP17186	A4722300111
2442 LS	OM 471.900;OM 471.909		07/11-	10S15C	R134a	DCP17186	A4722300111
2443 LS	OM 470.906		07/11-	10S15C	R134a	DCP17186	A4722300111
2445 LS	OM 471.900;OM 471.909		07/11-	10S15C	R134a	DCP17186	A4722300111
2448 LS	OM 471.900		07/11-	10S15C	R134a	DCP17186	A4722300111
2451 LS	OM 471.900;OM 471.909		07/11-	10S15C	R134a	DCP17186	A4722300111
2527 L	OM 936.912		07/11-	10S15C	R134a	DCP17185	
2527 LS	OM 936.912		07/11-	10S15C	R134a	DCP17185	
2530 L	OM 936.912		07/11-	10S15C	R134a	DCP17185	
2530 LS	OM 936.912		07/11-	10S15C	R134a	DCP17185	
2532 L	OM 936.916		07/11-	10S15C	R134a	DCP17185	
2532 LS	OM 936.916		07/11-	10S15C	R134a	DCP17185	
2533 L	OM 470.906		07/11-	10S15C	R134a	DCP17186	A4722300111
2533 LS	OM 470.906		07/11-	10S15C	R134a	DCP17186	A4722300111
2535 L	OM 936.916		07/11-	10S15C	R134a	DCP17185	
2535 LS	OM 936.916		07/11-	10S15C	R134a	DCP17185	
2536 L	OM 470.906		07/11-	10S15C	R134a	DCP17186	A4722300111
2536 LS	OM 470.906		07/11-	10S15C	R134a	DCP17186	A4722300111
2540 L	OM 470.906		07/11-	10S15C	R134a	DCP17186	A4722300111
2540 LS	OM 470.906		07/11-	10S15C	R134a	DCP17186	A4722300111
2542 L	OM 471.900; OM 471.909		07/11-	10S15C	R134a	DCP17186	A4722300111
2542 LS	OM 471.900;OM 471.909		07/11-	10S15C	R134a	DCP17186	A4722300111
2543 L	OM 470.906		07/11-	10S15C	R134a	DCP17186	A4722300111
2543 LS	OM 470.906		07/11-	10S15C	R134a	DCP17186	A4722300111
2545 L	OM 471.900; OM 471.909		07/11-	10S15C	R134a	DCP17186	A4722300111
2545 LS	OM 471.900;OM 471.909		07/11-	10S15C	R134a	DCP17186	A4722300111
2548 L	OM 471.900		07/11-	10S15C	R134a	DCP17186	A4722300111
2548 LS	OM 471.900		07/11-	10S15C	R134a	DCP17186	A4722300111
2551 L	OM 471.900; OM 471.909		07/11-	10S15C	R134a	DCP17186	A4722300111
2551 LS	OM 471.900;OM 471.909		07/11-	10S15C	R134a	DCP17186	A4722300111
2627 L	OM 936.912		07/11-	10S15C	R134a	DCP17185	
2627 LS	OM 936.912		07/11-	10S15C	R134a	DCP17185	
2630 L	OM 936.912		07/11-	10S15C	R134a	DCP17185	
2630 LS	OM 936.912		07/11-	10S15C	R134a	DCP17185	
2632 L	OM 936.916		07/11-	10S15C	R134a	DCP17185	
2632 LS	OM 936.916		07/11-	10S15C	R134a	DCP17185	
2633 L	OM 470.906		07/11-	10S15C	R134a	DCP17186	A4722300111
2633 LS	OM 470.906		07/11-	10S15C	R134a	DCP17186	A4722300111
2635 L	OM 936.916		07/11-	10S15C	R134a	DCP17185	
2635 LS	OM 936.916		07/11-	10S15C	R134a	DCP17185	
2636 L	OM 470.906		07/11-	10S15C	R134a	DCP17186	A4722300111
2636 LS	OM 470.906		07/11-	10S15C	R134a	DCP17186	A4722300111
2640 L	OM 470.906		07/11-	10S15C	R134a	DCP17186	A4722300111
2640 LS	OM 470.906		07/11-	10S15C	R134a	DCP17186	A4722300111
2642 L	OM 471.900;OM 471.909		07/11-	10S15C	R134a	DCP17186	A4722300111
2642 LS	OM 471.900;OM 471.909		07/11-	10S15C	R134a	DCP17186	A4722300111
2643 L	OM 470.906		07/11-	10S15C	R134a	DCP17186	A4722300111
2643 LS	OM 470.906		07/11-	10S15C	R134a	DCP17186	A4722300111
2645 L	OM 471.900;OM 471.909		07/11-	10S15C	R134a	DCP17186	A4722300111
2645 LS	OM 471.900;OM 471.909		07/11-	10S15C	R134a	DCP17186	A4722300111
2648 L	OM 471.900		07/11-	10S15C	R134a	DCP17186	A4722300111
2648 LS	OM 471.900		07/11-	10S15C	R134a	DCP17186	A4722300111
2651 L	OM 471.900;OM 471.909		07/11-	10S15C	R134a	DCP17186	A4722300111
2651 LS	OM 471.900;OM 471.909		07/11-	10S15C	R134a	DCP17186	A4722300111
3333 L	OM 470.906		07/11-	10S15C	R134a	DCP17186	A4722300111
3333 LS	OM 470.906		07/11-	10S15C	R134a	DCP17186	A4722300111
3336 L	OM 470.906		07/11-	10S15C	R134a	DCP17186	A4722300111
3336 LS	OM 470.906		07/11-	10S15C	R134a	DCP17186	A4722300111
3340 L	OM 470.906		07/11-	10S15C	R134a	DCP17186	A4722300111
3340 LS	OM 470.906		07/11-	10S15C	R134a	DCP17186	A4722300111
3342 L	OM 471.900; OM 471.909		07/11-	10S15C	R134a	DCP17186	A4722300111





				TYPE	GAS	DENSO PN	OE
<b>MERCEDES-BENZ CV</b> <i>Continued</i>							
<b>ACTROS MP4 (11-)</b> <i>Continued</i>							
3342 LS	OM 471.900; OM 471.909		07/11-	10S15C	R134a	DCP17186	A4722300111
3343 L	OM 470.906		07/11-	10S15C	R134a	DCP17186	A4722300111
3343 LS	OM 470.906		07/11-	10S15C	R134a	DCP17186	A4722300111
3345 L	OM 471.900; OM 471.909		07/11-	10S15C	R134a	DCP17186	A4722300111
3345 LS	OM 471.900; OM 471.909		07/11-	10S15C	R134a	DCP17186	A4722300111
3348 L	OM 471.900		07/11-	10S15C	R134a	DCP17186	A4722300111
3348 LS	OM 471.900		07/11-	10S15C	R134a	DCP17186	A4722300111
3351 L	OM 471.900; OM 471.909		07/11-	10S15C	R134a	DCP17186	A4722300111
3351 LS	OM 471.900; OM 471.909		07/11-	10S15C	R134a	DCP17186	A4722300111
4152 LS	OM 473.900		01/14-	10S15C	R134a	DCP17186	A4722300111
<b>ANTOS (12-)</b>							
1824 L	OM 936.912		07/12-	10S15C	R134a	DCP17185	
1824 LS	OM 936.912		07/12-	10S15C	R134a	DCP17185	
1827 L	OM 936.912		07/12-	10S15C	R134a	DCP17185	
1827 LS	OM 936.912		07/12-	10S15C	R134a	DCP17185	
1830 L	OM 936.912		07/12-	10S15C	R134a	DCP17185	
1830 LS	OM 936.912		07/12-	10S15C	R134a	DCP17185	
1832 L	OM 936.916		07/12-	10S15C	R134a	DCP17185	
1832 LS	OM 936.916		07/12-	10S15C	R134a	DCP17185	
1833 L	OM 470.906		07/12-	10S15C	R134a	DCP17186	A4722300111
1833 LS	OM 470.906		07/12-	10S15C	R134a	DCP17186	A4722300111
1835 L	OM 936.916		07/12-	10S15C	R134a	DCP17185	
1835 LS	OM 936.916		07/12-	10S15C	R134a	DCP17185	
1836 L	OM 470.906		07/12-	10S15C	R134a	DCP17186	A4722300111
1836 LS	OM 470.906		07/12-	10S15C	R134a	DCP17186	A4722300111
1840 L	OM 470.906		07/12-	10S15C	R134a	DCP17186	A4722300111
1840 LS	OM 470.906		07/12-	10S15C	R134a	DCP17186	A4722300111
1842 L	OM 471.900		07/12-	10S15C	R134a	DCP17186	A4722300111
1842 LS	OM 471.900		07/12-	10S15C	R134a	DCP17186	A4722300111
1843 L	OM 470.906		07/12-	10S15C	R134a	DCP17186	A4722300111
1843 LS	OM 470.906		07/12-	10S15C	R134a	DCP17186	A4722300111
1845 L	OM 471.900		07/12-	10S15C	R134a	DCP17186	A4722300111
1845 LS	OM 471.900		07/12-	10S15C	R134a	DCP17186	A4722300111
1848 L	OM 471.900		07/12-	10S15C	R134a	DCP17186	A4722300111
1848 LS	OM 471.900		07/12-	10S15C	R134a	DCP17186	A4722300111
1851 L	OM 471.900		07/12-	10S15C	R134a	DCP17186	A4722300111
1851 LS	OM 471.900		07/12-	10S15C	R134a	DCP17186	A4722300111
2024 L	OM 936.912		07/12-	10S15C	R134a	DCP17185	
2024 LS	OM 936.912		07/12-	10S15C	R134a	DCP17185	
2027 L	OM 936.912		07/12-	10S15C	R134a	DCP17185	
2027 LS	OM 936.912		07/12-	10S15C	R134a	DCP17185	
2030 L	OM 936.912		07/12-	10S15C	R134a	DCP17185	
2030 LS	OM 936.912		07/12-	10S15C	R134a	DCP17185	
2032 L	OM 936.916		07/12-	10S15C	R134a	DCP17185	
2032 LS	OM 936.916		07/12-	10S15C	R134a	DCP17185	
2033 L	OM 470.906		07/12-	10S15C	R134a	DCP17186	A4722300111
2033 LS	OM 470.906		07/12-	10S15C	R134a	DCP17186	A4722300111
2035 L	OM 936.916		07/12-	10S15C	R134a	DCP17185	
2035 LS	OM 936.916		07/12-	10S15C	R134a	DCP17185	
2036 L	OM 470.906		07/12-	10S15C	R134a	DCP17186	A4722300111
2036 LS	OM 470.906		07/12-	10S15C	R134a	DCP17186	A4722300111
2040 L	OM 470.906		07/12-	10S15C	R134a	DCP17186	A4722300111
2040 LS	OM 470.906		07/12-	10S15C	R134a	DCP17186	A4722300111
2042 L	OM 471.900		07/12-	10S15C	R134a	DCP17186	A4722300111
2042 LS	OM 471.900		07/12-	10S15C	R134a	DCP17186	A4722300111
2043 L	OM 470.906		07/12-	10S15C	R134a	DCP17186	A4722300111
2043 LS	OM 470.906		07/12-	10S15C	R134a	DCP17186	A4722300111
2045 L	OM 471.900		07/12-	10S15C	R134a	DCP17186	A4722300111
2045 LS	OM 471.900		07/12-	10S15C	R134a	DCP17186	A4722300111
2048 L	OM 471.900		07/12-	10S15C	R134a	DCP17186	A4722300111
2048 LS	OM 471.900		07/12-	10S15C	R134a	DCP17186	A4722300111
2051 L	OM 471.900		07/12-	10S15C	R134a	DCP17186	A4722300111
2051 LS	OM 471.900		07/12-	10S15C	R134a	DCP17186	A4722300111
2427 LS	OM 936.912		07/12-	10S15C	R134a	DCP17185	
2430 LS	OM 936.912		07/12-	10S15C	R134a	DCP17185	
2432 LS	OM 936.916		07/12-	10S15C	R134a	DCP17185	
2433 LS	OM 470.906		07/12-	10S15C	R134a	DCP17186	A4722300111
2435 LS	OM 936.916		07/12-	10S15C	R134a	DCP17185	



				TYPE	GAS	DENSO PN	OE
<b>MERCEDES-BENZ CV</b> <i>Continued</i>							
<b>ANTOS (12-)</b> <i>Continued</i>							
2436 LS	OM 470.906			07/12-	10S15C	R134a	DCP17186 A4722300111
2440 LS	OM 470.906			07/12-	10S15C	R134a	DCP17186 A4722300111
2442 LS	OM 471.900			07/12-	10S15C	R134a	DCP17186 A4722300111
2443 LS	OM 470.906			07/12-	10S15C	R134a	DCP17186 A4722300111
2445 LS	OM 471.900			07/12-	10S15C	R134a	DCP17186 A4722300111
2448 LS	OM 471.900			07/12-	10S15C	R134a	DCP17186 A4722300111
2451 LS	OM 471.900			07/12-	10S15C	R134a	DCP17186 A4722300111
2527 L	OM 936.912			07/12-	10S15C	R134a	DCP17185
2527 LS	OM 936.912			07/12-	10S15C	R134a	DCP17185
2530 L	OM 936.912			07/12-	10S15C	R134a	DCP17185
2530 LS	OM 936.912			07/12-	10S15C	R134a	DCP17185
2532 L	OM 936.916			07/12-	10S15C	R134a	DCP17185
2532 LS	OM 936.916			07/12-	10S15C	R134a	DCP17185
2533 L	OM 470.906			07/12-	10S15C	R134a	DCP17186 A4722300111
2533 LS	OM 470.906			07/12-	10S15C	R134a	DCP17186 A4722300111
2535 L	OM 936.916			07/12-	10S15C	R134a	DCP17185
2535 LS	OM 936.916			07/12-	10S15C	R134a	DCP17185
2536 L	OM 470.906			07/12-	10S15C	R134a	DCP17186 A4722300111
2536 LS	OM 470.906			07/12-	10S15C	R134a	DCP17186 A4722300111
2540 L	OM 470.906			07/12-	10S15C	R134a	DCP17186 A4722300111
2540 LS	OM 470.906			07/12-	10S15C	R134a	DCP17186 A4722300111
2542 L	OM 471.900			07/12-	10S15C	R134a	DCP17186 A4722300111
2542 LS	OM 471.900			07/12-	10S15C	R134a	DCP17186 A4722300111
2543 L	OM 470.906			07/12-	10S15C	R134a	DCP17186 A4722300111
2543 LS	OM 470.906			07/12-	10S15C	R134a	DCP17186 A4722300111
2545 L	OM 471.900			07/12-	10S15C	R134a	DCP17186 A4722300111
2545 LS	OM 471.900;OM 471.909			07/12-	10S15C	R134a	DCP17186 A4722300111
2548 L	OM 471.900			07/12-	10S15C	R134a	DCP17186 A4722300111
2548 LS	OM 471.900;OM 471.909			07/12-	10S15C	R134a	DCP17186 A4722300111
2551 L	OM 471.900			07/12-	10S15C	R134a	DCP17186 A4722300111
2551 LS	OM 471.900			07/12-	10S15C	R134a	DCP17186 A4722300111
2627 L	OM 936.912			07/12-	10S15C	R134a	DCP17185
2627 LS	OM 936.912			07/12-	10S15C	R134a	DCP17185
2630 L	OM 936.912			07/12-	10S15C	R134a	DCP17185
2630 LS	OM 936.912			07/12-	10S15C	R134a	DCP17185
2632 L	OM 936.916			07/12-	10S15C	R134a	DCP17185
2632 LS	OM 936.916			07/12-	10S15C	R134a	DCP17185
2633 L	OM 470.906			07/12-	10S15C	R134a	DCP17186 A4722300111
2633 LS	OM 470.906			07/12-	10S15C	R134a	DCP17186 A4722300111
2635 L	OM 936.916			07/12-	10S15C	R134a	DCP17185
2635 LS	OM 936.916			07/12-	10S15C	R134a	DCP17185
2636 L	OM 470.906			07/12-	10S15C	R134a	DCP17186 A4722300111
2636 LS	OM 470.906			07/12-	10S15C	R134a	DCP17186 A4722300111
2640 L	OM 470.906			07/12-	10S15C	R134a	DCP17186 A4722300111
2640 LS	OM 470.906			07/12-	10S15C	R134a	DCP17186 A4722300111
2642 L	OM 471.900			07/12-	10S15C	R134a	DCP17186 A4722300111
2642 LS	OM 471.900			07/12-	10S15C	R134a	DCP17186 A4722300111
2643 L	OM 470.906			07/12-	10S15C	R134a	DCP17186 A4722300111
2643 LS	OM 470.906			07/12-	10S15C	R134a	DCP17186 A4722300111
2645 L	OM 471.900			07/12-	10S15C	R134a	DCP17186 A4722300111
2645 LS	OM 471.900			07/12-	10S15C	R134a	DCP17186 A4722300111
2648 L	OM 471.900			07/12-	10S15C	R134a	DCP17186 A4722300111
2648 LS	OM 471.900			07/12-	10S15C	R134a	DCP17186 A4722300111
2651 L	OM 471.900			07/12-	10S15C	R134a	DCP17186 A4722300111
2651 LS	OM 471.900			07/12-	10S15C	R134a	DCP17186 A4722300111
3333 L	OM 470.906			07/12-	10S15C	R134a	DCP17186 A4722300111
3333 LS	OM 470.906			07/12-	10S15C	R134a	DCP17186 A4722300111
3336 L	OM 470.906			07/12-	10S15C	R134a	DCP17186 A4722300111
3336 LS	OM 470.906			07/12-	10S15C	R134a	DCP17186 A4722300111
3340 L	OM 470.906			07/12-	10S15C	R134a	DCP17186 A4722300111
3340 LS	OM 470.906			07/12-	10S15C	R134a	DCP17186 A4722300111
3342 L	OM 471.900			07/12-	10S15C	R134a	DCP17186 A4722300111
3342 LS	OM 471.900			07/12-	10S15C	R134a	DCP17186 A4722300111
3343 L	OM 470.906			07/12-	10S15C	R134a	DCP17186 A4722300111
3343 LS	OM 470.906			07/12-	10S15C	R134a	DCP17186 A4722300111
3345 L	OM 471.900			07/12-	10S15C	R134a	DCP17186 A4722300111
3345 LS	OM 471.900			07/12-	10S15C	R134a	DCP17186 A4722300111
3348 L	OM 471.900			07/12-	10S15C	R134a	DCP17186 A4722300111





				TYPE	GAS	DENSO PN	OE
<b>MERCEDES-BENZ CV</b> <i>Continued</i>							
<b>ANTOS (12-)</b> <i>Continued</i>							
3348 LS	OM 471.900		07/12-	10S15C	R134a	DCP17186	A4722300111
3351 L	OM 471.900		07/12-	10S15C	R134a	DCP17186	A4722300111
3351 LS	OM 471.900		07/12-	10S15C	R134a	DCP17186	A4722300111
<b>AROCS (13-)</b>							
1833	OM 470.906		01/13-	10S15C	R134a	DCP17186	A4722300111
1833 A	OM 470.906		01/13-	10S15C	R134a	DCP17186	A4722300111
1833 AK	OM 470.906		01/13-	10S15C	R134a	DCP17186	A4722300111
1833 AS	OM 470.906		01/13-	10S15C	R134a	DCP17186	A4722300111
1833 K	OM 470.906		01/13-	10S15C	R134a	DCP17186	A4722300111
1833 LS	OM 470.906		01/13-	10S15C	R134a	DCP17186	A4722300111
1840	OM 470.906		01/13-	10S15C	R134a	DCP17186	A4722300111
1840 A	OM 470.906		01/13-	10S15C	R134a	DCP17186	A4722300111
1840 AK	OM 470.906		01/13-	10S15C	R134a	DCP17186	A4722300111
1840 AS	OM 470.906		01/13-	10S15C	R134a	DCP17186	A4722300111
1840 K	OM 470.906		01/13-	10S15C	R134a	DCP17186	A4722300111
1840 LS	OM 470.906		01/13-	10S15C	R134a	DCP17186	A4722300111
1842	OM 471.900		01/13-	10S15C	R134a	DCP17186	A4722300111
1842 A	OM 471.900		01/13-	10S15C	R134a	DCP17186	A4722300111
1842 AK	OM 471.900		01/13-	10S15C	R134a	DCP17186	A4722300111
1842 AS	OM 471.900		01/13-	10S15C	R134a	DCP17186	A4722300111
1842 K	OM 471.900		01/13-	10S15C	R134a	DCP17186	A4722300111
1842 LS	OM 471.900		01/13-	10S15C	R134a	DCP17186	A4722300111
1843	OM 470.906		01/13-	10S15C	R134a	DCP17186	A4722300111
1843 A	OM 470.906		01/13-	10S15C	R134a	DCP17186	A4722300111
1843 AK	OM 470.906		01/13-	10S15C	R134a	DCP17186	A4722300111
1843 AS	OM 470.906		01/13-	10S15C	R134a	DCP17186	A4722300111
1843 K	OM 470.906		01/13-	10S15C	R134a	DCP17186	A4722300111
1843 LS	OM 470.906		01/13-	10S15C	R134a	DCP17186	A4722300111
1845	OM 471.900; OM 471.906		01/13-	10S15C	R134a	DCP17186	A4722300111
1845 K	OM 471.900; OM 471.906		01/13-	10S15C	R134a	DCP17186	A4722300111
1845 LS	OM 471.900; OM 471.906		01/13-	10S15C	R134a	DCP17186	A4722300111
1848	OM 471.900; OM 471.906		01/13-	10S15C	R134a	DCP17186	A4722300111
1848 K	OM 471.900; OM 471.906		01/13-	10S15C	R134a	DCP17186	A4722300111
1848 LS	OM 471.900; OM 471.906		01/13-	10S15C	R134a	DCP17186	A4722300111
2033	OM 470.906		01/13-	10S15C	R134a	DCP17186	A4722300111
2033 A	OM 470.906		01/13-	10S15C	R134a	DCP17186	A4722300111
2033 AK	OM 470.906		01/13-	10S15C	R134a	DCP17186	A4722300111
2033 AS	OM 470.906		01/13-	10S15C	R134a	DCP17186	A4722300111
2033 K	OM 470.906		01/13-	10S15C	R134a	DCP17186	A4722300111
2033 S, 2033 LS	OM 470.906		01/13-	10S15C	R134a	DCP17186	A4722300111
2040	OM 470.906		01/13-	10S15C	R134a	DCP17186	A4722300111
2040 A	OM 470.906		01/13-	10S15C	R134a	DCP17186	A4722300111
2040 AK	OM 470.906		01/13-	10S15C	R134a	DCP17186	A4722300111
2040 AS	OM 470.906		01/13-	10S15C	R134a	DCP17186	A4722300111
2040 K	OM 470.906		01/13-	10S15C	R134a	DCP17186	A4722300111
2040 S, 2040 LS	OM 470.906		01/13-	10S15C	R134a	DCP17186	A4722300111
2042	OM 471.900		01/13-	10S15C	R134a	DCP17186	A4722300111
2042 A	OM 471.900		01/13-	10S15C	R134a	DCP17186	A4722300111
2042 AK	OM 471.900		01/13-	10S15C	R134a	DCP17186	A4722300111
2042 AS	OM 471.900		01/13-	10S15C	R134a	DCP17186	A4722300111
2042 K	OM 471.900		01/13-	10S15C	R134a	DCP17186	A4722300111
2042 S, 2042 LS	OM 471.900		01/13-	10S15C	R134a	DCP17186	A4722300111
2043	OM 470.906		01/13-	10S15C	R134a	DCP17186	A4722300111
2043 A	OM 470.906		01/13-	10S15C	R134a	DCP17186	A4722300111
2043 AK	OM 470.906		01/13-	10S15C	R134a	DCP17186	A4722300111
2043 AS	OM 470.906		01/13-	10S15C	R134a	DCP17186	A4722300111
2043 K	OM 470.906		01/13-	10S15C	R134a	DCP17186	A4722300111
2043 S, 2043 LS	OM 470.906		01/13-	10S15C	R134a	DCP17186	A4722300111
2045	OM 471.900; OM 471.906		01/13-	10S15C	R134a	DCP17186	A4722300111
2045 K	OM 471.900; OM 471.906		01/13-	10S15C	R134a	DCP17186	A4722300111
2045 S, 2045 LS	OM 471.900; OM 471.906		01/13-	10S15C	R134a	DCP17186	A4722300111
2048 K	OM 471.900; OM 471.906		01/13-	10S15C	R134a	DCP17186	A4722300111
2533 L	OM 470.906		01/13-	10S15C	R134a	DCP17186	A4722300111
2533 LS	OM 470.906		01/13-	10S15C	R134a	DCP17186	A4722300111
2540 L	OM 470.906		01/13-	10S15C	R134a	DCP17186	A4722300111
2540 LS	OM 470.906		01/13-	10S15C	R134a	DCP17186	A4722300111
2542 L	OM 471.900		01/13-	10S15C	R134a	DCP17186	A4722300111
2542 LS	OM 471.900		01/13-	10S15C	R134a	DCP17186	A4722300111











				TYPE	GAS	DENSO PN	OE
<b>MERCEDES-BENZ CV</b> <i>Continued</i>							
<b>AROCS (13-)</b> <i>Continued</i>							
2543 L	OM 470.906			01/13-	10S15C	R134a	DCP17186 A4722300111
2543 LS	OM 470.906			01/13-	10S15C	R134a	DCP17186 A4722300111
2545 L	OM 471.900; OM 471.906			01/13-	10S15C	R134a	DCP17186 A4722300111
2545 LS	OM 471.900; OM 471.906			01/13-	10S15C	R134a	DCP17186 A4722300111
2548 L	OM 471.900; OM 471.906			01/13-	10S15C	R134a	DCP17186 A4722300111
2633 B, 2633 LB	OM 470.906			01/13-	10S15C	R134a	DCP17186 A4722300111
2633 K, 2633 LK	OM 470.906			01/13-	10S15C	R134a	DCP17186 A4722300111
2633 L	OM 470.906			01/13-	10S15C	R134a	DCP17186 A4722300111
2633 LS	OM 470.906			01/13-	10S15C	R134a	DCP17186 A4722300111
2633 S, 2633 LS	OM 470.906			01/13-	10S15C	R134a	DCP17186 A4722300111
2633, 2633 L	OM 470.906			01/13-	10S15C	R134a	DCP17186 A4722300111
2640 B, 2640 LB	OM 470.906			01/13-	10S15C	R134a	DCP17186 A4722300111
2640 K, 2640 LK	OM 470.906			01/13-	10S15C	R134a	DCP17186 A4722300111
2640 L	OM 470.906			01/13-	10S15C	R134a	DCP17186 A4722300111
2640 LS	OM 470.906			01/13-	10S15C	R134a	DCP17186 A4722300111
2640 S, 2640 LS	OM 470.906			01/13-	10S15C	R134a	DCP17186 A4722300111
2640, 2640 L	OM 470.906			01/13-	10S15C	R134a	DCP17186 A4722300111
2642 B, 2642 LB	OM 471.900			01/13-	10S15C	R134a	DCP17186 A4722300111
2642 K, 2642 LK	OM 471.900			01/13-	10S15C	R134a	DCP17186 A4722300111
2642 L	OM 471.900			01/13-	10S15C	R134a	DCP17186 A4722300111
2642 LS	OM 471.900			01/13-	10S15C	R134a	DCP17186 A4722300111
2642 S, 2642 LS	OM 471.900			01/13-	10S15C	R134a	DCP17186 A4722300111
2642, 2642 L	OM 471.900			01/13-	10S15C	R134a	DCP17186 A4722300111
2643 B, 2643 LB	OM 470.906			01/13-	10S15C	R134a	DCP17186 A4722300111
2643 K, 2643 LK	OM 470.906			01/13-	10S15C	R134a	DCP17186 A4722300111
2643 L	OM 470.906			01/13-	10S15C	R134a	DCP17186 A4722300111
2643 LS	OM 470.906			01/13-	10S15C	R134a	DCP17186 A4722300111
2643 S, 2643 LS	OM 470.906			01/13-	10S15C	R134a	DCP17186 A4722300111
2643, 2643 L	OM 470.906			01/13-	10S15C	R134a	DCP17186 A4722300111
2645 B, 2645 LB	OM 471.900			01/13-	10S15C	R134a	DCP17186 A4722300111
2645 K, 2645 LK	OM 471.900			01/13-	10S15C	R134a	DCP17186 A4722300111
2645 L	OM 471.900			01/13-	10S15C	R134a	DCP17186 A4722300111
2645 LS	OM 471.900			01/13-	10S15C	R134a	DCP17186 A4722300111
2645 S, 2645 LS	OM 471.900; OM 471.906			01/13-	10S15C	R134a	DCP17186 A4722300111
2645, 2645 L	OM 471.900; OM 471.906			01/13-	10S15C	R134a	DCP17186 A4722300111
2648 LS	OM 471.900			01/13-	10S15C	R134a	DCP17186 A4722300111
3233 B, 3233 LB	OM 470.906			01/13-	10S15C	R134a	DCP17186 A4722300111
3233 K, 3233 LK	OM 470.906			01/13-	10S15C	R134a	DCP17186 A4722300111
3233 L	OM 470.906			01/13-	10S15C	R134a	DCP17186 A4722300111
3233 LB	OM 470.906			01/13-	10S15C	R134a	DCP17186 A4722300111
3233 LK	OM 470.906			01/13-	10S15C	R134a	DCP17186 A4722300111
3233, 3233 L	OM 470.906			01/13-	10S15C	R134a	DCP17186 A4722300111
3240 B, 3240 LB	OM 470.906			01/13-	10S15C	R134a	DCP17186 A4722300111
3240 K, 3240 LK	OM 470.906			01/13-	10S15C	R134a	DCP17186 A4722300111
3240 L	OM 470.906			01/13-	10S15C	R134a	DCP17186 A4722300111
3240 LB	OM 470.906			01/13-	10S15C	R134a	DCP17186 A4722300111
3240 LK	OM 470.906			01/13-	10S15C	R134a	DCP17186 A4722300111
3240, 3240 L	OM 470.906			01/13-	10S15C	R134a	DCP17186 A4722300111
3242 B, 3242 LB	OM 471.900			01/13-	10S15C	R134a	DCP17186 A4722300111
3242 K, 3242 LK	OM 471.900			01/13-	10S15C	R134a	DCP17186 A4722300111
3242 L	OM 471.900			01/13-	10S15C	R134a	DCP17186 A4722300111
3242 LB	OM 471.900			01/13-	10S15C	R134a	DCP17186 A4722300111
3242 LK	OM 471.900			01/13-	10S15C	R134a	DCP17186 A4722300111
3242, 3242 L	OM 471.900			01/13-	10S15C	R134a	DCP17186 A4722300111
3243 B, 3243 LB	OM 470.906			01/13-	10S15C	R134a	DCP17186 A4722300111
3243 K, 3243 LK	OM 470.906			01/13-	10S15C	R134a	DCP17186 A4722300111
3243 L	OM 470.906			01/13-	10S15C	R134a	DCP17186 A4722300111
3243 LB	OM 470.906			01/13-	10S15C	R134a	DCP17186 A4722300111
3243 LK	OM 470.906			01/13-	10S15C	R134a	DCP17186 A4722300111
3243, 3243 L	OM 470.906			01/13-	10S15C	R134a	DCP17186 A4722300111
3245 K, 3245 LK	OM 471.900			01/13-	10S15C	R134a	DCP17186 A4722300111
3245 L	OM 471.900			01/13-	10S15C	R134a	DCP17186 A4722300111
3245 LB	OM 471.900			01/13-	10S15C	R134a	DCP17186 A4722300111
3245 LK	OM 471.900			01/13-	10S15C	R134a	DCP17186 A4722300111
3245, 3245 L	OM 471.900			01/13-	10S15C	R134a	DCP17186 A4722300111
3333 A	OM 470.906			01/13-	10S15C	R134a	DCP17186 A4722300111
3333 AK	OM 470.906			01/13-	10S15C	R134a	DCP17186 A4722300111
3333 AS	OM 470.906			01/13-	10S15C	R134a	DCP17186 A4722300111





				TYPE	GAS	DENSO PN	OE
<b>MERCEDES-BENZ CV</b> <i>Continued</i>							
<b>AROCS (13-)</b> <i>Continued</i>							
3333 B, 3333 LB	OM 470.906			01/13-	10S15C	R134a	DCP17186 A4722300111
3333 K, 3333 LK	OM 470.906			01/13-	10S15C	R134a	DCP17186 A4722300111
3333 S, 3333 LS	OM 470.906			01/13-	10S15C	R134a	DCP17186 A4722300111
3333, 3333 L	OM 470.906			01/13-	10S15C	R134a	DCP17186 A4722300111
3340 A	OM 470.906			01/13-	10S15C	R134a	DCP17186 A4722300111
3340 AK	OM 470.906			01/13-	10S15C	R134a	DCP17186 A4722300111
3340 AS	OM 470.906			01/13-	10S15C	R134a	DCP17186 A4722300111
3340 B, 3340 LB	OM 470.906			01/13-	10S15C	R134a	DCP17186 A4722300111
3340 K, 3340 LK	OM 470.906			01/13-	10S15C	R134a	DCP17186 A4722300111
3340 S, 3340 LS	OM 470.906			01/13-	10S15C	R134a	DCP17186 A4722300111
3340, 3340 L	OM 470.906			01/13-	10S15C	R134a	DCP17186 A4722300111
3342 A	OM 471.900			01/13-	10S15C	R134a	DCP17186 A4722300111
3342 AK	OM 471.900			01/13-	10S15C	R134a	DCP17186 A4722300111
3342 AS	OM 471.900			01/13-	10S15C	R134a	DCP17186 A4722300111
3342 B, 3342 LB	OM 471.900			01/13-	10S15C	R134a	DCP17186 A4722300111
3342 K, 3342 LK	OM 471.900			01/13-	10S15C	R134a	DCP17186 A4722300111
3342 S, 3342 LS	OM 471.900			01/13-	10S15C	R134a	DCP17186 A4722300111
3342, 3342 L	OM 471.900			01/13-	10S15C	R134a	DCP17186 A4722300111
3343 A	OM 470.906			01/13-	10S15C	R134a	DCP17186 A4722300111
3343 AK	OM 470.906			01/13-	10S15C	R134a	DCP17186 A4722300111
3343 AS	OM 470.906			01/13-	10S15C	R134a	DCP17186 A4722300111
3343 B, 3343 LB	OM 470.906			01/13-	10S15C	R134a	DCP17186 A4722300111
3343 K, 3343 LK	OM 470.906			01/13-	10S15C	R134a	DCP17186 A4722300111
3343 S, 3343 LS	OM 470.906			01/13-	10S15C	R134a	DCP17186 A4722300111
3343, 3343 L	OM 470.906			01/13-	10S15C	R134a	DCP17186 A4722300111
3345, 3345 L	OM 471.900			01/13-	10S15C	R134a	DCP17186 A4722300111
3345B, 3345 LB	OM 471.900			01/13-	10S15C	R134a	DCP17186 A4722300111
3345K, 3345 LK	OM 471.900			01/13-	10S15C	R134a	DCP17186 A4722300111
3345S, 3345 LS	OM 471.900			01/13-	10S15C	R134a	DCP17186 A4722300111
3348 B, 3348 LB	OM 471.900			01/13-	10S15C	R134a	DCP17186 A4722300111
3348 K, 3348 LK	OM 471.900			01/13-	10S15C	R134a	DCP17186 A4722300111
3348 S, 3348 LS	OM 471.900			01/13-	10S15C	R134a	DCP17186 A4722300111
3348, 3348 L	OM 471.900			01/13-	10S15C	R134a	DCP17186 A4722300111
4133	OM 470.906			01/13-	10S15C	R134a	DCP17186 A4722300111
4133 AK	OM 470.903			01/13-	10S15C	R134a	DCP17186 A4722300111
4133 B	OM 470.906			01/13-	10S15C	R134a	DCP17186 A4722300111
4133 K	OM 470.906			01/13-	10S15C	R134a	DCP17186 A4722300111
4136 AK	OM 470.903			01/13-	10S15C	R134a	DCP17186 A4722300111
4140	OM 470.906			01/13-	10S15C	R134a	DCP17186 A4722300111
4140 AK	OM 470.903			01/13-	10S15C	R134a	DCP17186 A4722300111
4140 B	OM 470.906			01/13-	10S15C	R134a	DCP17186 A4722300111
4140 K	OM 470.906			01/13-	10S15C	R134a	DCP17186 A4722300111
4142	OM 471.900			01/13-	10S15C	R134a	DCP17186 A4722300111
4142 B	OM 471.900			01/13-	10S15C	R134a	DCP17186 A4722300111
4142 K	OM 471.900			01/13-	10S15C	R134a	DCP17186 A4722300111
4143	OM 470.906			01/13-	10S15C	R134a	DCP17186 A4722300111
4143 AK	OM 470.903			01/13-	10S15C	R134a	DCP17186 A4722300111
4143 B	OM 470.906			01/13-	10S15C	R134a	DCP17186 A4722300111
4143 K	OM 470.906			01/13-	10S15C	R134a	DCP17186 A4722300111
4145	OM 471.900			01/13-	10S15C	R134a	DCP17186 A4722300111
4145 B	OM 471.900			01/13-	10S15C	R134a	DCP17186 A4722300111
4145 K	OM 471.900			01/13-	10S15C	R134a	DCP17186 A4722300111
4148	OM 471.900			01/13-	10S15C	R134a	DCP17186 A4722300111
4148 B	OM 471.900			01/13-	10S15C	R134a	DCP17186 A4722300111
4148 K	OM 471.900			01/13-	10S15C	R134a	DCP17186 A4722300111
<b>ATEGO 3 (13-)</b>							
716 K	OM 934.911			04/13-	10S15C	R134a	DCP17185 A9362300111
716, 716 L	OM 934.911			04/13-	10S15C	R134a	DCP17185 A9362300111
718 K	OM 934.911			04/13-	10S15C	R134a	DCP17185 A9362300111
718, 718 L	OM 934.911			04/13-	10S15C	R134a	DCP17185 A9362300111
721 K	OM 934.913			04/13-	10S15C	R134a	DCP17185 A9362300111
721, 721 L	OM 934.913			04/13-	10S15C	R134a	DCP17185 A9362300111
723 K	OM 934.913			04/13-	10S15C	R134a	DCP17185 A9362300111
723, 723 L	OM 934.913			04/13-	10S15C	R134a	DCP17185 A9362300111
816 K	OM 934.911			04/13-	10S15C	R134a	DCP17185 A9362300111
816, 816 L	OM 934.911			04/13-	10S15C	R134a	DCP17185 A9362300111
818 K	OM 934.911			04/13-	10S15C	R134a	DCP17185 A9362300111
818, 818 L	OM 934.911			04/13-	10S15C	R134a	DCP17185 A9362300111





				TYPE	GAS	DENSO PN	OE
<b>MERCEDES-BENZ CV</b> <i>Continued</i>							
<b>ATEGO 3 (13-)</b> <i>Continued</i>							
821 K	OM 934.913		04/13-	10S15C	R134a	DCP17185	A9362300111
821, 821 L	OM 934.913		04/13-	10S15C	R134a	DCP17185	A9362300111
823 K	OM 934.913		04/13-	10S15C	R134a	DCP17185	A9362300111
823, 823 L	OM 934.913		04/13-	10S15C	R134a	DCP17185	A9362300111
916 K	OM 934.911		04/13-	10S15C	R134a	DCP17185	A9362300111
916, 916 L	OM 934.911		04/13-	10S15C	R134a	DCP17185	A9362300111
918 AF	OM 934.911		04/13-	10S15C	R134a	DCP17185	A9362300111
918 F	OM 934.911		04/13-	10S15C	R134a	DCP17185	A9362300111
918 K	OM 934.911		04/13-	10S15C	R134a	DCP17185	A9362300111
918, 918 L	OM 934.911		04/13-	10S15C	R134a	DCP17185	A9362300111
921 K	OM 934.913		04/13-	10S15C	R134a	DCP17185	A9362300111
921, 921 L	OM 934.913		04/13-	10S15C	R134a	DCP17185	A9362300111
923 AF	OM 934.913		04/13-	10S15C	R134a	DCP17185	A9362300111
923 F	OM 934.913		04/13-	10S15C	R134a	DCP17185	A9362300111
923 K	OM 934.913		04/13-	10S15C	R134a	DCP17185	A9362300111
923, 923 L	OM 934.913		04/13-	10S15C	R134a	DCP17185	A9362300111
1016 K	OM 934.911		04/13-	10S15C	R134a	DCP17185	A9362300111
1016, 1016 L	OM 934.911		04/13-	10S15C	R134a	DCP17185	A9362300111
1018 A	OM 934.911		04/13-	10S15C	R134a	DCP17185	A9362300111
1018 AK	OM 934.911		04/13-	10S15C	R134a	DCP17185	A9362300111
1018 K	OM 934.911		04/13-	10S15C	R134a	DCP17185	A9362300111
1018 KO	OM 934.911		04/13-	10S15C	R134a	DCP17185	A9362300111
1018, 1018 L	OM 934.911		04/13-	10S15C	R134a	DCP17185	A9362300111
1021 A	OM 934.913		04/13-	10S15C	R134a	DCP17185	A9362300111
1021 AK	OM 934.913		04/13-	10S15C	R134a	DCP17185	A9362300111
1021 K	OM 934.913		04/13-	10S15C	R134a	DCP17185	A9362300111
1021 KO	OM 934.913		04/13-	10S15C	R134a	DCP17185	A9362300111
1021, 1021 L	OM 934.913		04/13-	10S15C	R134a	DCP17185	A9362300111
1023 A	OM 934.913		04/13-	10S15C	R134a	DCP17185	A9362300111
1023 AK	OM 934.913		04/13-	10S15C	R134a	DCP17185	A9362300111
1023 K	OM 934.913		04/13-	10S15C	R134a	DCP17185	A9362300111
1023 KO	OM 934.913		04/13-	10S15C	R134a	DCP17185	A9362300111
1023, 1023 L	OM 934.913		04/13-	10S15C	R134a	DCP17185	A9362300111
1216 K	OM 934.911		04/13-	10S15C	R134a	DCP17185	A9362300111
1216, 1216 L	OM 934.911		04/13-	10S15C	R134a	DCP17185	A9362300111
1218 K	OM 934.911		04/13-	10S15C	R134a	DCP17185	A9362300111
1218, 1218 L	OM 934.911		04/13-	10S15C	R134a	DCP17185	A9362300111
1221 K	OM 934.913		04/13-	10S15C	R134a	DCP17185	A9362300111
1221, 1221 L	OM 934.913		04/13-	10S15C	R134a	DCP17185	A9362300111
1223 AF	OM 934.913		04/13-	10S15C	R134a	DCP17185	A9362300111
1223 F	OM 934.913		04/13-	10S15C	R134a	DCP17185	A9362300111
1223 K	OM 934.913		04/13-	10S15C	R134a	DCP17185	A9362300111
1223, 1223 L	OM 934.913		04/13-	10S15C	R134a	DCP17185	A9362300111
1318 A	OM 934.911		04/13-	10S15C	R134a	DCP17185	A9362300111
1318 AK	OM 934.911		04/13-	10S15C	R134a	DCP17185	A9362300111
1318 K	OM 934.911		04/13-	10S15C	R134a	DCP17185	A9362300111
1318 LKO	OM 934.911		04/13-	10S15C	R134a	DCP17185	A9362300111
1318, 1318 L	OM 934.911		04/13-	10S15C	R134a	DCP17185	A9362300111
1321 A	OM 934.913		04/13-	10S15C	R134a	DCP17185	A9362300111
1321 AK	OM 934.913		04/13-	10S15C	R134a	DCP17185	A9362300111
1321 K	OM 934.913		04/13-	10S15C	R134a	DCP17185	A9362300111
1321 LKO	OM 934.913		04/13-	10S15C	R134a	DCP17185	A9362300111
1321 LS	OM 934.913		04/13-	10S15C	R134a	DCP17185	A9362300111
1321, 1321 L	OM 934.913		04/13-	10S15C	R134a	DCP17185	A9362300111
1323 A	OM 934.913		04/13-	10S15C	R134a	DCP17185	A9362300111
1323 AF	OM 934.913		04/13-	10S15C	R134a	DCP17185	A9362300111
1323 AK	OM 934.913		04/13-	10S15C	R134a	DCP17185	A9362300111
1323 F	OM 934.913		04/13-	10S15C	R134a	DCP17185	A9362300111
1323 K	OM 934.913		04/13-	10S15C	R134a	DCP17185	A9362300111
1323 LKO	OM 934.913		04/13-	10S15C	R134a	DCP17185	A9362300111
1323 LS	OM 934.913		04/13-	10S15C	R134a	DCP17185	A9362300111
1323, 1323 L	OM 934.913		04/13-	10S15C	R134a	DCP17185	A9362300111
1518 A	OM 934.911		04/13-	10S15C	R134a	DCP17185	A9362300111
1518 K	OM 934.911		04/13-	10S15C	R134a	DCP17185	A9362300111
1518, 1518 L	OM 934.911		04/13-	10S15C	R134a	DCP17185	A9362300111
1521 A	OM 934.913		04/13-	10S15C	R134a	DCP17185	A9362300111
1521 AK	OM 934.913		04/13-	10S15C	R134a	DCP17185	A9362300111
1521 K	OM 934.913		04/13-	10S15C	R134a	DCP17185	A9362300111

				TYPE	GAS	DENSO PN	OE
<b>MERCEDES-BENZ CV</b> <i>Continued</i>							
<b>ATEGO 3 (13-)</b> <i>Continued</i>							
1521, 1521 L	OM 934.913		04/13-	10S15C	R134a	DCP17185	A9362300111
1523 A	OM 934.913		04/13-	10S15C	R134a	DCP17185	A9362300111
1523 AK	OM 934.913		04/13-	10S15C	R134a	DCP17185	A9362300111
1523 K	OM 934.913		04/13-	10S15C	R134a	DCP17185	A9362300111
1523, 1523 L	OM 934.913		04/13-	10S15C	R134a	DCP17185	A9362300111
<b>ATEGO (98-04)</b>							
712	OM 904.909		01/98-10/04	10S15C	R134a	DCP17186	A4722300111
812	OM 904.909		01/98-10/04	10S15C	R134a	DCP17186	A4722300111
<b>AXOR 2 (04-)</b>							
1835 LS	OM 457.937		01/11-	7SBU16C	R134a	DCP17113	A4572300111
1835 LS	OM 457.937		01/11-	BODY 7SBU16C	R134a	DCP17B29	A0002343711
1836 LS, LLS	OM 457.937; OM 457.948; OM 457.980		10/04-	7SBU16C	R134a	DCP17113	A4572300111
1836 LS, LLS	OM 457.937; OM 457.948; OM 457.980		10/04-	BODY 7SBU16C	R134a	DCP17B29	A0002343711
1840 LS, LLS	OM 457.937; OM 457.948; OM 457.955; OM 457.980		10/04-	7SBU16C	R134a	DCP17113	A4572300111
1840 LS, LLS	OM 457.937; OM 457.948; OM 457.955; OM 457.980		10/04-	BODY 7SBU16C	R134a	DCP17B29	A0002343711
1843 LS, LLS	OM 457.937; OM 457.948; OM 457.980		10/04-	7SBU16C	R134a	DCP17113	A4572300111
1843 LS, LLS	OM 457.937; OM 457.948; OM 457.980		10/04-	BODY 7SBU16C	R134a	DCP17B29	A0002343711
2035 S, 2036 S, LS	OM 457.910; OM 457.917; OM 457.918		01/11-	7SBU16C	R134a	DCP17113	A4572300111
2035 S, 2036 S, LS	OM 457.910; OM 457.917; OM 457.918		01/11-	BODY 7SBU16C	R134a	DCP17B29	A0002343711
2040 S, 2041 S, 2041 S, 2041 LS	OM 457.910; OM 457.917; OM 457.918		01/11-	7SBU16C	R134a	DCP17113	A4572300111
2040 S, 2041 S, 2041 S, 2041 LS	OM 457.910; OM 457.917; OM 457.918		01/11-	BODY 7SBU16C	R134a	DCP17B29	A0002343711
2044 S	OM 457.910; OM 457.917; OM 457.918		01/11-	7SBU16C	R134a	DCP17113	A4572300111
2044 S	OM 457.910; OM 457.917; OM 457.918		01/11-	BODY 7SBU16C	R134a	DCP17B29	A0002343711
2436 LS, 2536 LS	OM 457.948; OM 457.980		10/04-	7SBU16C	R134a	DCP17113	A4572300111
2436 LS, 2536 LS	OM 457.948; OM 457.980		10/04-	BODY 7SBU16C	R134a	DCP17B29	A0002343711
2440 LS, 2540 LS	OM 457.948; OM 457.981		10/04-	7SBU16C	R134a	DCP17113	A4572300111
2440 LS, 2540 LS	OM 457.948; OM 457.981		10/04-	BODY 7SBU16C	R134a	DCP17B29	A0002343711
2443 LS, 2543 LS	OM 457.948; OM 457.980		10/04-	7SBU16C	R134a	DCP17113	A4572300111
2443 LS, 2543 LS	OM 457.948; OM 457.980		10/04-	BODY 7SBU16C	R134a	DCP17B29	A0002343711
2535 L, 2536 L, 2536 LL	OM 457.937; OM 457.948; OM 457.980		10/04-	7SBU16C	R134a	DCP17113	A4572300111
2535 L, 2536 L, 2536 LL	OM 457.937; OM 457.948; OM 457.980		10/04-	BODY 7SBU16C	R134a	DCP17B29	A0002343711
2535 S, 2535 LS	OM 457.918; OM 457.981		10/04-	7SBU16C	R134a	DCP17113	A4572300111
2535 S, 2535 LS	OM 457.918; OM 457.981		10/04-	BODY 7SBU16C	R134a	DCP17B29	A0002343711
2540 L, LL	OM 457.937; OM 457.948; OM 457.980		10/04-	7SBU16C	R134a	DCP17113	A4572300111
2540 L, LL	OM 457.937; OM 457.948; OM 457.980		10/04-	BODY 7SBU16C	R134a	DCP17B29	A0002343711
2540 S, 2541 S, LS	OM 457.918; OM 457.980		10/04-	7SBU16C	R134a	DCP17113	A4572300111
2540 S, 2541 S, LS	OM 457.918; OM 457.980		10/04-	BODY 7SBU16C	R134a	DCP17B29	A0002343711
2543 L, LL	OM 457.937; OM 457.948; OM 457.980		10/04-	7SBU16C	R134a	DCP17113	A4572300111
2543 L, LL	OM 457.937; OM 457.948; OM 457.980		10/04-	BODY 7SBU16C	R134a	DCP17B29	A0002343711
2543 S, 2543 LS	OM 457.980		10/04-	7SBU16C	R134a	DCP17113	A4572300111
2543 S, 2543 LS	OM 457.980		10/04-	BODY 7SBU16C	R134a	DCP17B29	A0002343711
2544 S, 2544 LS	OM 457.910; OM 457.922		10/04-	7SBU16C	R134a	DCP17113	A4572300111
2544 S, 2544 LS	OM 457.910; OM 457.922		10/04-	BODY 7SBU16C	R134a	DCP17B29	A0002343711
2635 B	OM 457.956; OM 457.957; OM 457.980; OM 457.981		10/05-	7SBU16C	R134a	DCP17113	A4572300111
2635 B	OM 457.956; OM 457.957; OM 457.980; OM 457.981		10/05-	BODY 7SBU16C	R134a	DCP17B29	A0002343711
2636	OM 457.937		10/04-	7SBU16C	R134a	DCP17113	A4572300111
2636	OM 457.937		10/04-	BODY 7SBU16C	R134a	DCP17B29	A0002343711
2636 B	OM 457.937; OM 457.948		10/04-	7SBU16C	R134a	DCP17113	A4572300111
2636 B	OM 457.937; OM 457.948		10/04-	BODY 7SBU16C	R134a	DCP17B29	A0002343711
2636 K	OM 457.937; OM 457.948; OM 457.956; OM 457.957; OM 457.980; OM 457.981		10/04-	7SBU16C	R134a	DCP17113	A4572300111
2636 K	OM 457.937; OM 457.948; OM 457.956; OM 457.957; OM 457.980; OM 457.981		10/04-	BODY 7SBU16C	R134a	DCP17B29	A0002343711





				TYPE	GAS	DENSO PN	OE
<b>MERCEDES-BENZ CV</b> <i>Continued</i>							
<b>AXOR 2 (04-)</b> <i>Continued</i>							
2640	OM 457.937		10/04-	7SBU16C	R134a	DCP17113	A4572300111
2640	OM 457.937		10/04-	BODY 7SBU16C	R134a	DCP17B29	A0002343711
2640 B	OM 457.956; OM 457.957; OM 457.980; OM 457.981		10/04-	7SBU16C	R134a	DCP17113	A4572300111
2640 B	OM 457.956; OM 457.957; OM 457.980; OM 457.981		10/04-	BODY 7SBU16C	R134a	DCP17B29	A0002343711
2640 K	OM 457.956; OM 457.957; OM 457.980; OM 457.981		10/04-	7SBU16C	R134a	DCP17113	A4572300111
2640 K	OM 457.956; OM 457.957; OM 457.980; OM 457.981		10/04-	BODY 7SBU16C	R134a	DCP17B29	A0002343711
2640 S, 2641 S, LS	OM 457.918		10/04-	7SBU16C	R134a	DCP17113	A4572300111
2640 S, 2641 S, LS	OM 457.918		10/04-	BODY 7SBU16C	R134a	DCP17B29	A0002343711
2643	OM 457.937		10/04-	7SBU16C	R134a	DCP17113	A4572300111
2643	OM 457.937		10/04-	BODY 7SBU16C	R134a	DCP17B29	A0002343711
2643 B	OM 457.956; OM 457.957; OM 457.980; OM 457.981		10/04-	7SBU16C	R134a	DCP17113	A4572300111
2643 B	OM 457.956; OM 457.957; OM 457.980; OM 457.981		10/04-	BODY 7SBU16C	R134a	DCP17B29	A0002343711
2643 K	OM 457.956; OM 457.957; OM 457.980; OM 457.981		10/04-	7SBU16C	R134a	DCP17113	A4572300111
2643 K	OM 457.956; OM 457.957; OM 457.980; OM 457.981		10/04-	BODY 7SBU16C	R134a	DCP17B29	A0002343711
2644 S, LS	OM 457.910; OM 457.918; OM 457.922; OM 457.937; OM 457.948		01/11-	7SBU16C	R134a	DCP17113	A4572300111
2644 S, LS	OM 457.910; OM 457.918; OM 457.922; OM 457.937; OM 457.948		01/11-	BODY 7SBU16C	R134a	DCP17B29	A0002343711
3235	OM 457.937; OM 457.948		10/04-	7SBU16C	R134a	DCP17113	A4572300111
3235	OM 457.937; OM 457.948		10/04-	BODY 7SBU16C	R134a	DCP17B29	A0002343711
3236 B	OM 457.956; OM 457.957; OM 457.980; OM 457.981		10/04-	7SBU16C	R134a	DCP17113	A4572300111
3236 B	OM 457.956; OM 457.957; OM 457.980; OM 457.981		10/04-	BODY 7SBU16C	R134a	DCP17B29	A0002343711
3236 K	OM 457.956; OM 457.957; OM 457.980; OM 457.981		10/04-	7SBU16C	R134a	DCP17113	A4572300111
3236 K	OM 457.956; OM 457.957; OM 457.980; OM 457.981		10/04-	BODY 7SBU16C	R134a	DCP17B29	A0002343711
3240	OM 457.937; OM 457.948		03/05-	7SBU16C	R134a	DCP17113	A4572300111
3240	OM 457.937; OM 457.948		03/05-	BODY 7SBU16C	R134a	DCP17B29	A0002343711
3240 B	OM 457.956; OM 457.957; OM 457.980; OM 457.981		10/04-	7SBU16C	R134a	DCP17113	A4572300111
3240 B	OM 457.956; OM 457.957; OM 457.980; OM 457.981		10/04-	BODY 7SBU16C	R134a	DCP17B29	A0002343711
3240 K	OM 457.956; OM 457.957		10/04-	7SBU16C	R134a	DCP17113	A4572300111
3240 K	OM 457.956; OM 457.957		10/04-	BODY 7SBU16C	R134a	DCP17B29	A0002343711
3243	OM 457.937; OM 457.948		10/04-	7SBU16C	R134a	DCP17113	A4572300111
3243	OM 457.937; OM 457.948		10/04-	BODY 7SBU16C	R134a	DCP17B29	A0002343711
3243 B	OM 457.956; OM 457.957; OM 457.980; OM 457.981		10/04-	7SBU16C	R134a	DCP17113	A4572300111
3243 B	OM 457.956; OM 457.957; OM 457.980; OM 457.981		10/04-	BODY 7SBU16C	R134a	DCP17B29	A0002343711
3243 K	OM 457.956; OM 457.957; OM 457.980; OM 457.981		10/04-	7SBU16C	R134a	DCP17113	A4572300111
3243 K	OM 457.956; OM 457.957; OM 457.980; OM 457.981		10/04-	BODY 7SBU16C	R134a	DCP17B29	A0002343711
3335	OM 457.937		10/04-	7SBU16C	R134a	DCP17113	A4572300111
3335	OM 457.937		10/04-	BODY 7SBU16C	R134a	DCP17B29	A0002343711
3335 B	OM 457.956; OM 457.957		10/04-10/05	7SBU16C	R134a	DCP17113	A4572300111
3335 B	OM 457.956; OM 457.957		10/04-10/05	BODY 7SBU16C	R134a	DCP17B29	A0002343711
3335 K	OM 457.956; OM 457.957		06/09-	7SBU16C	R134a	DCP17113	A4572300111
3335 K	OM 457.956; OM 457.957		06/09-	BODY 7SBU16C	R134a	DCP17B29	A0002343711
3335 S	OM 457.962		09/08-	7SBU16C	R134a	DCP17113	A4572300111
3335 S	OM 457.962		09/08-	BODY 7SBU16C	R134a	DCP17B29	A0002343711
3340 B	OM 457.956; OM 457.957		10/04-10/05	7SBU16C	R134a	DCP17113	A4572300111
3340 B	OM 457.956; OM 457.957		10/04-10/05	BODY 7SBU16C	R134a	DCP17B29	A0002343711
3340 K, 3341 K	OM 457.910; OM 457.917; OM 457.918; OM 457.937; OM 457.956; OM 457.957		10/04-	7SBU16C	R134a	DCP17113	A4572300111





				TYPE	GAS	DENSO PN	OE
<b>MERCEDES-BENZ CV</b> <i>Continued</i>							
<b>AXOR 2 (04-)</b> <i>Continued</i>							
3340 K, 3341 K	OM 457.910; OM 457.917; OM 457.918; OM 457.937; OM 457.956; OM 457.957		10/04-	BODY 7SBU16C	R134a	DCP17B29	A0002343711
3340 S, 3341 S	OM 457.910; OM 457.917; OM 457.918; OM 457.962		06/09-	7SBU16C	R134a	DCP17113	A4572300111
3340 S, 3341 S	OM 457.910; OM 457.917; OM 457.918; OM 457.962		06/09-	BODY 7SBU16C	R134a	DCP17B29	A0002343711
3340, 3341	OM 457.910; OM 457.917; OM 457.918; OM 457.937		10/04-	7SBU16C	R134a	DCP17113	A4572300111
3340, 3341	OM 457.910; OM 457.917; OM 457.918; OM 457.937		10/04-	BODY 7SBU16C	R134a	DCP17B29	A0002343711
3343	OM 457.937		10/04-	7SBU16C	R134a	DCP17113	A4572300111
3343	OM 457.937		10/04-	BODY 7SBU16C	R134a	DCP17B29	A0002343711
3343 B	OM 457.956; OM 457.957		10/04-	7SBU16C	R134a	DCP17113	A4572300111
3343 B	OM 457.956; OM 457.957		10/04-	BODY 7SBU16C	R134a	DCP17B29	A0002343711
3343 K	OM 457.910; OM 457.917; OM 457.918		01/11-	7SBU16C	R134a	DCP17113	A4572300111
3343 K	OM 457.910; OM 457.917; OM 457.918		01/11-	BODY 7SBU16C	R134a	DCP17B29	A0002343711
3343 S	OM 457.910; OM 457.917; OM 457.918		01/11-	7SBU16C	R134a	DCP17113	A4572300111
3343 S	OM 457.910; OM 457.917; OM 457.918		01/11-	BODY 7SBU16C	R134a	DCP17B29	A0002343711
3344	OM 457.910; OM 457.961		10/04-	7SBU16C	R134a	DCP17113	A4572300111
3344	OM 457.910; OM 457.961		10/04-	BODY 7SBU16C	R134a	DCP17B29	A0002343711
3344 K	OM 457.910; OM 457.917; OM 457.918; OM 457.956; OM 457.957; OM 457.961		10/04-	7SBU16C	R134a	DCP17113	A4572300111
3344 K	OM 457.910; OM 457.917; OM 457.918; OM 457.956; OM 457.957; OM 457.961		10/04-	BODY 7SBU16C	R134a	DCP17B29	A0002343711
3344 S	OM 457.910; OM 457.961		10/04-	7SBU16C	R134a	DCP17113	A4572300111
3344 S	OM 457.910; OM 457.961		10/04-	BODY 7SBU16C	R134a	DCP17B29	A0002343711
3535 K	OM 457.937		06/09-	7SBU16C	R134a	DCP17113	A4572300111
3535 K	OM 457.937		06/09-	BODY 7SBU16C	R134a	DCP17B29	A0002343711
4135 B	OM 457.956; OM 457.957		10/05-	7SBU16C	R134a	DCP17113	A4572300111
4135 B	OM 457.956; OM 457.957		10/05-	BODY 7SBU16C	R134a	DCP17B29	A0002343711
4135 K	OM 457.956; OM 457.957		06/09-	7SBU16C	R134a	DCP17113	A4572300111
4135 K	OM 457.956; OM 457.957		06/09-	BODY 7SBU16C	R134a	DCP17B29	A0002343711
4140	OM 457.910; OM 457.917; OM 457.918		01/11-	7SBU16C	R134a	DCP17113	A4572300111
4140	OM 457.910; OM 457.917; OM 457.918		01/11-	BODY 7SBU16C	R134a	DCP17B29	A0002343711
4140 B	OM 457.956; OM 457.957		01/11-	7SBU16C	R134a	DCP17113	A4572300111
4140 B	OM 457.956; OM 457.957		01/11-	BODY 7SBU16C	R134a	DCP17B29	A0002343711
4140 K	OM 457.956; OM 457.957		06/09-	7SBU16C	R134a	DCP17113	A4572300111
4140 K	OM 457.956; OM 457.957		06/09-	BODY 7SBU16C	R134a	DCP17B29	A0002343711
4141 K			01/11-	7SBU16C	R134a	DCP17113	A4572300111
4141 K			01/11-	BODY 7SBU16C	R134a	DCP17B29	A0002343711
4143 B	OM 457.956; OM 457.957		01/11-	7SBU16C	R134a	DCP17113	A4572300111
4143 B	OM 457.956; OM 457.957		01/11-	BODY 7SBU16C	R134a	DCP17B29	A0002343711
4143 K	OM 457.956; OM 457.957		06/09-	7SBU16C	R134a	DCP17113	A4572300111
4143 K	OM 457.956; OM 457.957		06/09-	BODY 7SBU16C	R134a	DCP17B29	A0002343711
4144	OM 457.910; OM 457.917; OM 457.918		01/11-	7SBU16C	R134a	DCP17113	A4572300111
4144	OM 457.910; OM 457.917; OM 457.918		01/11-	BODY 7SBU16C	R134a	DCP17B29	A0002343711
4144 K	OM 457.961		10/04-	7SBU16C	R134a	DCP17113	A4572300111
4144 K	OM 457.961		10/04-	BODY 7SBU16C	R134a	DCP17B29	A0002343711
<b>AXOR (02-04)</b>							
1835 LS	OM 457.937		01/02-10/04	7SBU16C	R134a	DCP17113	A4572300111
1835 LS	OM 457.937		01/02-10/04	BODY 7SBU16C	R134a	DCP17B29	A0002343711
1840 LS	OM 457.937		01/02-10/04	7SBU16C	R134a	DCP17113	A4572300111
1840 LS	OM 457.937		01/02-10/04	BODY 7SBU16C	R134a	DCP17B29	A0002343711
1843 LS	OM 457.937		01/02-10/04	7SBU16C	R134a	DCP17113	A4572300111
1843 LS	OM 457.937		01/02-10/04	BODY 7SBU16C	R134a	DCP17B29	A0002343711
2535 LS	OM 457.937; OM 457.948		01/02-10/04	7SBU16C	R134a	DCP17113	A4572300111





				TYPE	GAS	DENSO PN	OE
<b>MERCEDES-BENZ CV</b> <i>Continued</i>							
<b>AXOR (02-04)</b> <i>Continued</i>							
2535 LS	OM 457.937; OM 457.948		01/02-10/04	BODY 7SBU16C	R134a	DCP17B29	A0002343711
2540 LS	OM 457.937; OM 457.948		01/02-10/04	7SBU16C	R134a	DCP17113	A4572300111
2540 LS	OM 457.937; OM 457.948		01/02-10/04	BODY 7SBU16C	R134a	DCP17B29	A0002343711
2543 LS	OM 457.937; OM 457.948		01/02-10/04	7SBU16C	R134a	DCP17113	A4572300111
2543 LS	OM 457.937; OM 457.948		01/02-10/04	BODY 7SBU16C	R134a	DCP17B29	A0002343711
<b>SK</b>							
2435	OM 440.941; OM 440.942; OM 442.942; OM 442.944; OM 442.962; OM 442.963; OM 442.966; OM 442.976; OM 442.978		01/89-09/96	10PA15C	R134a	DCP17033	
3538	OM 402.971; OM 402.972; OM 402.973; OM 402.974; OM 402.975; OM 402.977; OM 402.978; OM 402.982; OM 402.983; OM 402.984; OM 402.985		09/91-09/96	10PA15C	R134a	DCP17033	
<b>SK (87-96)</b>							
1728, 1729, 1729 L	OM 442.906; OM 442.907; OM 442.908; OM 442.923; OM 442.925		01/89-09/96	10PA15C	R134a	DCP17033	
1729 AK	OM 442.907; OM 442.926		01/89-09/93	10PA15C	R134a	DCP17033	
1729 K	OM 442.906; OM 442.907; OM 442.925		01/89-08/94	10PA15C	R134a	DCP17033	
1729 S, 1729 LS	OM 442.906; OM 442.907; OM 442.923; OM 442.925		01/89-09/96	10PA15C	R134a	DCP17033	
1735 AK	OM 442.942; OM 442.966		08/89-08/94	10PA15C	R134a	DCP17033	
1735 K	OM 440.940; OM 442.944; OM 442.963; OM 442.964; OM 442.976		01/89-08/94	10PA15C	R134a	DCP17033	
1735 L	OM 442.906		01/89-08/94	10PA15C	R134a	DCP17033	
1735 S, 1735 LS	OM 442.944; OM 442.963; OM 442.964; OM 442.976		01/89-09/96	10PA15C	R134a	DCP17033	
1735, 1735 L	OM 442.944; OM 442.963; OM 442.964; OM 442.976		01/89-09/96	10PA15C	R134a	DCP17033	
1748 S, 1748 LS	OM 442.985; OM 442.989		01/89-09/96	10PA15C	R134a	DCP17033	
1748, 1748 L	OM 442.985; OM 442.989		01/89-09/96	10PA15C	R134a	DCP17033	
1831 AK	OM 401.986		05/91-09/96	10PA15C	R134a	DCP17033	
1831 AK	OM 445.930		01/94-09/96	10PA15C	R134a	DCP17033	
1831 K	OM 401.972; OM 401.979; OM 401.993		07/92-09/96	10PA15C	R134a	DCP17033	
1831 K	OM 441.986; OM 441.993; OM 445.929; OM 445.937		07/92-09/96	10PA15C	R134a	DCP17033	
1831 S, 1831 LS	OM 401.972; OM 401.979; OM 401.993		01/89-09/96	10PA15C	R134a	DCP17033	
1831 S, 1831 LS	OM 445.929; OM 445.937		01/89-09/96	10PA15C	R134a	DCP17033	
1831, 1831 L	OM 401.972; OM 401.979; OM 401.993		01/89-09/96	10PA15C	R134a	DCP17033	
1831, 1831 L	OM 445.929; OM 445.937		01/89-09/96	10PA15C	R134a	DCP17033	
1834 AK	OM 441.989		01/89-09/93	10PA15C	R134a	DCP17033	
1834 S, 1834 LS	OM 441.986; OM 441.996; OM 445.920; OM 445.939		01/89-09/96	10PA15C	R134a	DCP17033	
1834, 1834 L	OM 441.986; OM 441.996; OM 445.920; OM 445.939		01/89-09/96	10PA15C	R134a	DCP17033	
1838 AK	OM 402.978; OM 402.996		12/92-09/96	10PA15C	R134a	DCP17033	
1838 AK	OM 440.979; OM 440.982; OM 446.927		12/92-09/96	10PA15C	R134a	DCP17033	
1838 K	OM 402.971; OM 402.975; OM 402.985		12/90-09/96	10PA15C	R134a	DCP17033	
1838 K	OM 446.924		06/95-09/96	10PA15C	R134a	DCP17033	
1838 S, 1838 LS	OM 402.971; OM 402.972; OM 402.975; OM 402.985; OM 402.986		01/89-09/96	10PA15C	R134a	DCP17033	
1838 S, 1838 LS	OM 440.978; OM 440.991; OM 446.924; OM 446.925; OM 446.943		01/89-09/96	10PA15C	R134a	DCP17033	
1838, 1838 L	OM 402.971; OM 402.972; OM 402.975; OM 402.985; OM 402.986		01/89-09/96	10PA15C	R134a	DCP17033	
1838, 1838 L	OM 440.978; OM 440.991; OM 446.924; OM 446.925		01/89-09/96	10PA15C	R134a	DCP17033	
1840 LS	OM 402.971		07/91-07/92	10PA15C	R134a	DCP17033	
1844 S, 1844 LS	OM 440.970; OM 440.978; OM 446.922		01/89-09/96	10PA15C	R134a	DCP17033	
1844, 1844 L	OM 440.970; OM 440.978; OM 446.922		01/89-09/96	10PA15C	R134a	DCP17033	
1850 K	OM 442.997		01/89-08/94	10PA15C	R134a	DCP17033	
1850 LAS	OM 440.973; OM 442.985; OM 442.992		01/89-09/96	10PA15C	R134a	DCP17033	
1850 S, 1850 LS	OM 440.973; OM 442.985; OM 442.989; OM 442.992; OM 442.997		01/89-09/96	10PA15C	R134a	DCP17033	
1850, 1850 L	OM 440.973; OM 442.985; OM 442.989; OM 442.992; OM 442.997		01/89-09/96	10PA15C	R134a	DCP17033	
1853 AK	OM 446.920; OM 446.946		01/96-09/96	10PA15C	R134a	DCP17033	
1853 S, 1853 LS	OM 446.920		01/89-09/96	10PA15C	R134a	DCP17033	
1853, 1853 L	OM 446.920		01/89-09/96	10PA15C	R134a	DCP17033	
1922	OM 441.905; OM 441.914; OM 441.923		05/89-08/94	10PA15C	R134a	DCP17033	
1922 AK	OM 441.914; OM 441.926		08/89-08/94	10PA15C	R134a	DCP17033	
1922 K	OM 441.905; OM 441.914; OM 441.923		05/89-08/94	10PA15C	R134a	DCP17033	
1922 S	OM 441.905; OM 441.914; OM 441.923		05/89-08/94	10PA15C	R134a	DCP17033	





				TYPE	GAS	DENSO PN	OE
<b>MERCEDES-BENZ CV</b> <i>Continued</i>							
<b>SK (87-96)</b> <i>Continued</i>							
1929 A	OM 442.906;OM 442.907;OM 442.909; OM 442.924			01/89-08/94	10PA15C	R134a	DCP17033
1929 A	OM 443.940			01/89-08/94	10PA15C	R134a	DCP17033
1929 AK	OM 442.906; OM 442.907; OM 442.909; OM 442.924			01/89-08/94	10PA15C	R134a	DCP17033
1929 AS	OM 442.906; OM 442.907; OM 442.926; OM 442.929			01/89-08/94	10PA15C	R134a	DCP17033
1929 K	OM 442.906; OM 442.907; OM 442.908; OM 442.916; OM 442.923; OM 442.925			01/89-08/94	10PA15C	R134a	DCP17033
1929 S	OM 442.906; OM 442.907; OM 442.908; OM 442.916; OM 442.923; OM 442.925			01/89-08/94	10PA15C	R134a	DCP17033
1929,1929 L	OM 442.906; OM 442.907; OM 442.908; OM 442.916; OM 442.923; OM 442.925			01/89-09/96	10PA15C	R134a	DCP17033
1935	OM 442.943; OM 442.944; OM 442.963; OM 442.966; OM 442.971; OM 442.976			05/89-08/94	10PA15C	R134a	DCP17033
1935 AK	OM 442.942; OM 442.966; OM 442.971; OM 442.972; OM 442.978			05/89-08/94	10PA15C	R134a	DCP17033
1935 AS	OM 442.942; OM 442.966; OM 442.978			05/89-08/94	10PA15C	R134a	DCP17033
1935 K	OM 440.940; OM 442.943; OM 442.944; OM 442.963; OM 442.964; OM 442.977			05/89-08/94	10PA15C	R134a	DCP17033
1935 S	OM 442.943; OM 442.944; OM 442.963; OM 442.976			05/89-08/94	10PA15C	R134a	DCP17033
1945 AK	OM 443.940			01/89-08/94	10PA15C	R134a	DCP17033
1948	OM 442.982; OM 442.984; OM 442.985; OM 442.989			01/89-07/92	10PA15C	R134a	DCP17033
2024	OM 401.975			02/93-09/96	10PA15C	R134a	DCP17033
2024	OM 445.924			01/94-09/96	10PA15C	R134a	DCP17033
2024 AK	OM 401.984			02/93-09/96	10PA15C	R134a	DCP17033
2024 AK	OM 445.925			01/94-09/96	10PA15C	R134a	DCP17033
2024 K	OM 401.975			02/93-09/96	10PA15C	R134a	DCP17033
2024 K	OM 445.924			01/94-09/96	10PA15C	R134a	DCP17033
2027 AK	OM 401.989			02/93-09/96	10PA15C	R134a	DCP17033
2027 AK	OM 445.933			02/93-09/96	10PA15C	R134a	DCP17033
2031	OM 401.972; OM 401.979; OM 401.993			03/92-09/96	10PA15C	R134a	DCP17033
2031 A	OM 401.986			03/92-09/96	10PA15C	R134a	DCP17033
2031 A	OM 445.930			01/94-09/96	10PA15C	R134a	DCP17033
2031 A	OM 402.978;OM 402.996;OM 440.979			03/92-09/96	10PA15C	R134a	DCP17033
2031 A	OM 446.927			01/94-09/96	10PA15C	R134a	DCP17033
2031 AS	OM 401.986			03/92-09/96	10PA15C	R134a	DCP17033
2031 K	OM 401.972; OM 401.979; OM 401.993			03/92-09/96	10PA15C	R134a	DCP17033
2031 K	OM 445.929			03/92-09/96	10PA15C	R134a	DCP17033
2031 S	OM 401.972; OM 401.979; OM 401.993			03/92-09/96	10PA15C	R134a	DCP17033
2038	OM 402.971; OM 402.972; OM 402.985; OM 402.986; OM 402.996			11/91-09/96	10PA15C	R134a	DCP17033
2038	OM 446.925; OM 446.927			12/92-09/96	10PA15C	R134a	DCP17033
2038 AS	OM 402.978			12/92-09/96	10PA15C	R134a	DCP17033
2038 AS	OM 440.970;OM 440.979;OM 446.927			12/92-09/96	10PA15C	R134a	DCP17033
2038 S	OM 402.971; OM 402.985			11/91-09/96	10PA15C	R134a	DCP17033
2044	OM 440.970; OM 440.978; OM 446.922			01/92-09/96	10PA15C	R134a	DCP17033
2044 AS	OM 440.970; OM 440.979			01/94-09/96	10PA15C	R134a	DCP17033
2044 S	OM 440.970; OM 446.922			01/92-09/96	10PA15C	R134a	DCP17033
2050	OM 442.985; OM 442.989; OM 442.992; OM 442.997; OM 446.920			01/91-09/96	10PA15C	R134a	DCP17033
2050 S	OM 440.976; OM 442.985; OM 442.989; OM 442.992; OM 442.997; OM 446.920			01/91-09/96	10PA15C	R134a	DCP17033
2055 AF	OM 442.997			01/92-09/96	10PA15C	R134a	DCP17033
2422 L	OM 441.905; OM 441.923			01/89-09/96	10PA15C	R134a	DCP17033
2429	OM 422.916			01/89-09/96	10PA15C	R134a	DCP17033
2429	OM 442.906; OM 442.907; OM 442.923; OM 442.925			01/89-08/94	10PA15C	R134a	DCP17033
2429 K	OM 442.906; OM 442.907; OM 442.923; OM 442.925			01/89-08/94	10PA15C	R134a	DCP17033
2429 S	OM 442.906; OM 442.907; OM 442.925			01/89-08/94	10PA15C	R134a	DCP17033
2429 S,2429 LS	OM 442.906; OM 442.907; OM 442.925			01/89-09/96	10PA15C	R134a	DCP17033
2429, 2429 L	OM 442.906; OM 442.907; OM 442.908; OM 442.916; OM 442.923; OM 442.925			01/89-09/96	10PA15C	R134a	DCP17033
2429,2429 L	OM 442.906; OM 442.907; OM 442.925			01/89-09/96	10PA15C	R134a	DCP17033
2434 L	OM 441.986; OM 441.989			01/89-09/96	10PA15C	R134a	DCP17033
2435	OM 442.943; OM 442.944; OM 442.963; OM 442.964; OM 442.965; OM 442.976			01/89-08/94	10PA15C	R134a	DCP17033
2435 K	OM 440.940; OM 442.943; OM 442.944; OM 442.963; OM 442.964; OM 442.965			01/89-08/94	10PA15C	R134a	DCP17033
2435 LS	OM 442.944; OM 442.963; OM 442.976			01/89-09/96	10PA15C	R134a	DCP17033











				TYPE	GAS	DENSO PN	OE
<b>MERCEDES-BENZ CV</b> <i>Continued</i>							
<b>SK (87-96)</b> <i>Continued</i>							
2435 S	OM 440.940; OM 442.943; OM 442.944; OM 442.963; OM 442.964; OM 442.965; OM 442.976		01/89-08/94	10PA15C	R134a	DCP17033	
2435 S,2435 LS	OM 442.943; OM 442.944; OM 442.963; OM 442.964; OM 442.965; OM 442.968; OM 442.976		01/89-09/96	10PA15C	R134a	DCP17033	
2435,2435 L	OM 442.943; OM 442.944; OM 442.963; OM 442.964; OM 442.965; OM 442.968; OM 442.976		01/89-09/96	10PA15C	R134a	DCP17033	
2448	OM 442.985; OM 442.992		01/89-07/92	10PA15C	R134a	DCP17033	
2448 LS	OM 442.984; OM 442.985; OM 442.989		01/89-07/92	10PA15C	R134a	DCP17033	
2448 S	OM 442.985; OM 442.989; OM 442.992		01/89-07/92	10PA15C	R134a	DCP17033	
2448,2448 L	OM 442.984; OM 442.985; OM 442.989		01/89-09/96	10PA15C	R134a	DCP17033	
2531	OM 401.986		05/91-09/96	10PA15C	R134a	DCP17033	
2531	OM 445.930		05/91-09/96	10PA15C	R134a	DCP17033	
2531, 2531 L	OM 401.979; OM 401.986; OM 401.993		01/89-09/96	10PA15C	R134a	DCP17033	
2531, 2531 L	OM 445.929; OM 445.930; OM 445.937		01/89-09/96	10PA15C	R134a	DCP17033	
2534, 2534 L	OM 441.986; OM 441.996; OM 445.920; OM 445.939		01/89-09/96	10PA15C	R134a	DCP17033	
2538	OM 402.971; OM 402.972; OM 402.975; OM 402.985; OM 402.986; OM 402.989		03/91-09/96	10PA15C	R134a	DCP17033	
2538	OM 440.970; OM 440.971; OM 440.978; OM 440.980; OM 440.981; OM 442.997; OM 446.924; OM 446.925		03/91-09/96	10PA15C	R134a	DCP17033	
2538 K, 2538 LK	OM 402.971; OM 402.972; OM 402.975; OM 402.985; OM 402.986; OM 402.989		03/91-09/96	10PA15C	R134a	DCP17033	
2538 K, 2538 LK	OM 440.970; OM 440.971; OM 440.978; OM 440.980; OM 440.981; OM 442.989; OM 442.997; OM 446.924; OM 446.925		03/91-09/96	10PA15C	R134a	DCP17033	
2538 S	OM 440.971; OM 440.981		03/91-09/96	10PA15C	R134a	DCP17033	
2538 S,2538 LS	OM 402.971; OM 402.972; OM 402.975; OM 402.985; OM 402.986; OM 402.989; OM 402.990		01/89-09/96	10PA15C	R134a	DCP17033	
2538 S,2538 LS	OM 440.970; OM 440.978; OM 440.980; OM 446.924; OM 446.925; OM 446.928; OM 446.929; OM 446.942; OM 446.948		01/89-09/96	10PA15C	R134a	DCP17033	
2538,2538 L	OM 402.971; OM 402.972; OM 402.975; OM 402.985; OM 402.986; OM 402.989		01/89-09/96	10PA15C	R134a	DCP17033	
2538,2538 L	OM 440.970; OM 440.978; OM 440.980; OM 446.924; OM 446.925		01/89-09/96	10PA15C	R134a	DCP17033	
2544	OM 440.970; OM 440.978		01/94-09/96	10PA15C	R134a	DCP17033	
2544 LS	OM 440.970; OM 440.978; OM 446.942		01/92-09/96	10PA15C	R134a	DCP17033	
2544 S	OM 440.970		01/89-08/94	10PA15C	R134a	DCP17033	
2544 S, LS	OM 440.970; OM 440.972; OM 446.922		01/92-09/96	10PA15C	R134a	DCP17033	
2544, 2544 L	OM 440.970; OM 440.978; OM 446.922		01/92-09/96	10PA15C	R134a	DCP17033	
2544,2544 L	OM 440.970; OM 440.978; OM 446.922		01/89-09/96	10PA15C	R134a	DCP17033	
2550	OM 440.971; OM 440.973; OM 442.989; OM 442.997		01/89-09/96	10PA15C	R134a	DCP17033	
2550 K	OM 440.971; OM 440.981; OM 442.989; OM 442.997		01/89-09/96	10PA15C	R134a	DCP17033	
2550 S, 2550 LS	OM 440.971; OM 440.973; OM 442.997; OM 442.998; OM 446.920		01/91-09/96	10PA15C	R134a	DCP17033	
2550,2550 L	OM 440.971; OM 440.973; OM 442.997; OM 442.998; OM 446.920		01/89-09/96	10PA15C	R134a	DCP17033	
2553 S, 2553 LS	OM 446.920		01/96-09/96	10PA15C	R134a	DCP17033	
2553,2553 L	OM 446.920		01/89-09/96	10PA15C	R134a	DCP17033	
2629	OM 442.959		01/89-08/94	10PA15C	R134a	DCP17033	
2629	OM 442.906; OM 442.907; OM 442.917; OM 442.925; OM 442.926; OM 442.929		01/89-08/94	10PA15C	R134a	DCP17033	
2629 A	OM 402.982		01/89-08/94	10PA15C	R134a	DCP17033	
2629 A	OM 440.970; OM 440.971; OM 442.942; OM 442.959; OM 442.966; OM 442.989; OM 442.997		01/89-08/94	10PA15C	R134a	DCP17033	
2629 A	OM 442.907; OM 442.926		01/89-08/94	10PA15C	R134a	DCP17033	
2629 A	OM 443.940		01/89-08/94	10PA15C	R134a	DCP17033	
2629 AK	OM 440.970; OM 440.971; OM 442.942; OM 442.959; OM 442.966; OM 442.989; OM 442.997		01/89-08/94	10PA15C	R134a	DCP17033	
2629 AK	OM 442.907; OM 442.926		01/89-08/94	10PA15C	R134a	DCP17033	
2629 AS	OM 442.989; OM 442.997		01/89-08/94	10PA15C	R134a	DCP17033	
2629 AS	OM 442.907; OM 442.926		01/89-08/94	10PA15C	R134a	DCP17033	
2629 B	OM 442.906; OM 442.907; OM 442.917; OM 442.925; OM 442.926; OM 442.929		01/89-08/94	10PA15C	R134a	DCP17033	
2629 K	OM 401.979		01/89-08/94	10PA15C	R134a	DCP17033	
2629 K	OM 442.989		01/89-08/94	10PA15C	R134a	DCP17033	
2629 K	OM 442.906; OM 442.907; OM 442.917; OM 442.925; OM 442.926; OM 442.929		01/89-08/94	10PA15C	R134a	DCP17033	





				TYPE	GAS	DENSO PN	OE
<b>MERCEDES-BENZ CV</b> <i>Continued</i>							
<b>SK (87-96)</b> <i>Continued</i>							
2629 S	OM 442.906; OM 442.907; OM 442.917; OM 442.925; OM 442.926; OM 442.929			01/89-08/94	10PA15C	R134a	DCP17033
2631	OM 401.972; OM 401.979; OM 401.981; OM 401.987; OM 401.993			06/92-09/96	10PA15C	R134a	DCP17033
2631	OM 441.998; OM 445.920; OM 445.929; OM 445.930; OM 445.931			06/92-09/96	10PA15C	R134a	DCP17033
2631 A	OM 401.986			06/92-09/96	10PA15C	R134a	DCP17033
2631 A	OM 445.930			01/94-09/96	10PA15C	R134a	DCP17033
2631 AK, 2634 AK	OM 401.986			06/92-09/96	10PA15C	R134a	DCP17033
2631 AK, 2634 AK	OM 445.930			01/94-09/96	10PA15C	R134a	DCP17033
2631 AS	OM 401.986			06/92-09/96	10PA15C	R134a	DCP17033
2631 B	OM 401.972; OM 401.979; OM 401.981; OM 401.987; OM 401.993			06/92-09/96	10PA15C	R134a	DCP17033
2631 K	OM 401.972; OM 401.979; OM 401.993			01/89-08/94	10PA15C	R134a	DCP17033
2631 K	OM 441.998; OM 445.929			01/89-08/94	10PA15C	R134a	DCP17033
2631 S	OM 401.972; OM 401.979; OM 401.981; OM 401.987; OM 401.993			06/92-09/96	10PA15C	R134a	DCP17033
2631 S	OM 441.998; OM 445.929; OM 445.930; OM 445.931			06/92-09/96	10PA15C	R134a	DCP17033
2634	OM 445.920			06/92-09/96	10PA15C	R134a	DCP17033
2634 S	OM 441.986			06/92-09/96	10PA15C	R134a	DCP17033
2635	OM 442.944; OM 442.964; OM 442.966; OM 442.976; OM 442.997			01/89-08/94	10PA15C	R134a	DCP17033
2635	OM 442.909; OM 442.923			01/89-08/94	10PA15C	R134a	DCP17033
2635 A	OM 440.970; OM 442.942; OM 442.966; OM 442.972			02/90-08/94	10PA15C	R134a	DCP17033
2635 AK	OM 440.941; OM 440.942; OM 440.971; OM 440.973; OM 442.942; OM 442.966; OM 442.972; OM 442.989; OM 442.997			02/90-08/94	10PA15C	R134a	DCP17033
2635 AS	OM 440.941; OM 440.942; OM 442.942; OM 442.966; OM 442.972; OM 442.989			02/90-09/96	10PA15C	R134a	DCP17033
2635 K	OM 402.971			01/91-08/94	10PA15C	R134a	DCP17033
2635 K	OM 440.940; OM 440.970; OM 442.944; OM 442.964; OM 442.966; OM 442.989; OM 442.994; OM 442.997			01/89-08/94	10PA15C	R134a	DCP17033
2635 S	OM 440.940; OM 442.944; OM 442.964; OM 442.966; OM 442.989; OM 442.994; OM 442.997			01/89-08/94	10PA15C	R134a	DCP17033
2638 A, LA	OM 402.975; OM 402.978; OM 402.996			09/91-09/96	10PA15C	R134a	DCP17033
2638 A, LA	OM 440.970; OM 440.979; OM 446.927			09/91-09/96	10PA15C	R134a	DCP17033
2638 AK	OM 402.975; OM 402.978; OM 402.996			07/92-09/96	10PA15C	R134a	DCP17033
2638 AK	OM 440.970; OM 440.979; OM 442.997; OM 446.927; OM 446.936			09/91-09/96	10PA15C	R134a	DCP17033
2638 AS	OM 402.975; OM 402.978; OM 402.996			07/92-09/96	10PA15C	R134a	DCP17033
2638 AS	OM 440.970; OM 440.979; OM 440.982; OM 446.927; OM 446.936			07/92-09/96	10PA15C	R134a	DCP17033
2638 K	OM 402.971; OM 402.972; OM 402.975; OM 402.985; OM 402.986			09/91-09/96	10PA15C	R134a	DCP17033
2638 K	OM 440.970; OM 440.978; OM 440.981; OM 440.990; OM 442.989; OM 442.997; OM 446.924; OM 446.925; OM 446.926			09/91-09/96	10PA15C	R134a	DCP17033
2638 S	OM 440.970; OM 440.978; OM 440.981; OM 442.997			09/91-09/96	10PA15C	R134a	DCP17033
2638, 2638 L	OM 402.971; OM 402.972; OM 402.975; OM 402.985; OM 402.986			09/91-09/96	10PA15C	R134a	DCP17033
2638, 2638 L	OM 440.970; OM 440.978; OM 440.981; OM 440.990; OM 446.924; OM 446.925; OM 446.926			09/91-09/96	10PA15C	R134a	DCP17033
2644 A	OM 440.970; OM 440.979; OM 446.936			01/92-09/96	10PA15C	R134a	DCP17033
2644 S	OM 440.970; OM 446.922			01/92-09/96	10PA15C	R134a	DCP17033
2644, 2644 L	OM 440.970; OM 440.978; OM 446.922			01/92-09/96	10PA15C	R134a	DCP17033
2645 AS	OM 442.989			02/90-09/96	10PA15C	R134a	DCP17033
2648 AK	OM 440.973; OM 442.989			02/90-08/94	10PA15C	R134a	DCP17033
2648 AS	OM 442.989; OM 442.997			01/89-08/94	10PA15C	R134a	DCP17033
2648 S	OM 442.983; OM 442.985; OM 442.989; OM 442.992; OM 442.994			01/89-07/92	10PA15C	R134a	DCP17033
2650 A	OM 440.982			01/89-09/96	10PA15C	R134a	DCP17033
2650 AK	OM 440.971; OM 442.989; OM 442.997			01/89-08/94	10PA15C	R134a	DCP17033
2650 AS	OM 440.971; OM 440.982; OM 442.989; OM 442.997			01/94-09/96	10PA15C	R134a	DCP17033
2650 K	OM 442.989; OM 442.994; OM 442.997			01/89-08/94	10PA15C	R134a	DCP17033
2650 S	OM 440.971; OM 440.973; OM 442.997			07/92-09/96	10PA15C	R134a	DCP17033
2650, 2650 L	OM 440.973; OM 440.981; OM 442.989; OM 442.997			07/92-09/96	10PA15C	R134a	DCP17033
2653 AK	OM 446.946			07/92-09/96	10PA15C	R134a	DCP17033
2653, 2653 L	OM 446.920			09/95-09/96	10PA15C	R134a	DCP17033
3050	OM 446.933			01/94-09/96	10PA15C	R134a	DCP17033





				TYPE	GAS	DENSO PN	OE
<b>MERCEDES-BENZ CV</b> <i>Continued</i>							
<b>SK (87-96)</b> <i>Continued</i>							
3053 S	OM 440.976			12/93-09/96	10PA15C	R134a	DCP17033
3229	OM 442.915; OM 442.916; OM 442.927; OM 442.928			09/89-08/94	10PA15C	R134a	DCP17033
3229 B	OM 442.915; OM 442.916; OM 442.927; OM 442.928			09/89-07/92	10PA15C	R134a	DCP17033
3229 K	OM 442.915; OM 442.916; OM 442.923; OM 442.927; OM 442.928			09/89-01/92	10PA15C	R134a	DCP17033
3233 B	OM 441.982; OM 441.985			10/90-07/92	10PA15C	R134a	DCP17033
3233 K	OM 441.982			10/90-07/92	10PA15C	R134a	DCP17033
3234 B	OM 441.988; OM 441.990; OM 441.992; OM 445.922			02/92-09/96	10PA15C	R134a	DCP17033
3234 K	OM 441.988; OM 441.990; OM 441.992; OM 445.922			02/92-09/96	10PA15C	R134a	DCP17033
3235	OM 442.944; OM 442.959; OM 442.963; OM 442.976			01/89-08/94	10PA15C	R134a	DCP17033
3235 K	OM 442.950; OM 442.952; OM 442.959			01/89-07/92	10PA15C	R134a	DCP17033
3235 L	OM 442.944; OM 442.963; OM 442.976			01/89-09/96	10PA15C	R134a	DCP17033
3236 A	OM 423.909			07/87-09/96	10P15C	R134a	DCP17021
3238	OM 402.971; OM 402.973; OM 402.977; OM 402.982; OM 402.987			10/90-09/96	10PA15C	R134a	DCP17033
3238	OM 402.971; OM 402.975; OM 402.985			03/91-09/96	10PA15C	R134a	DCP17033
3238	OM 440.971; OM 442.989; OM 442.997			10/90-09/96	10PA15C	R134a	DCP17033
3238	OM 446.924			03/91-09/96	10PA15C	R134a	DCP17033
3238	OM 423.905; OM 423.907			03/91-09/96	10PA15C	R134a	DCP17033
3238 L	OM 402.972; OM 402.985; OM 402.986			01/89-09/96	10PA15C	R134a	DCP17033
3238 L	OM 446.924; OM 446.925; OM 446.927			01/89-09/96	10PA15C	R134a	DCP17033
3238, 3238 L	OM 440.970; OM 440.980; OM 446.926; OM 446.939			10/90-09/96	10PA15C	R134a	DCP17033
3244	OM 440.970; OM 440.980; OM 446.939			01/94-09/96	10PA15C	R134a	DCP17033
3244 L	OM 440.970; OM 446.922			01/89-09/96	10PA15C	R134a	DCP17033
3248	OM 442.984; OM 442.985; OM 442.989; OM 442.992			01/89-09/96	10PA15C	R134a	DCP17033
3250 L	OM 440.971; OM 440.973; OM 440.975; OM 442.997			01/89-09/96	10PA15C	R134a	DCP17033
3253, 3253 L	OM 446.920; OM 446.933; OM 446.945			01/96-09/96	10PA15C	R134a	DCP17033
3255	OM 446.920			01/89-09/96	10PA15C	R134a	DCP17033
3529	OM 442.906; OM 442.907; OM 442.925			01/89-08/94	10PA15C	R134a	DCP17033
3534 K	OM 441.988; OM 445.922			10/93-09/96	10PA15C	R134a	DCP17033
3535	OM 442.942; OM 442.944; OM 442.959; OM 442.964; OM 442.966			01/89-08/94	10PA15C	R134a	DCP17033
3535 AK	OM 402.982; OM 402.983			03/91-08/94	10PA15C	R134a	DCP17033
3535 AK	OM 442.946; OM 442.957			02/90-08/94	10PA15C	R134a	DCP17033
3535 B	OM 442.945; OM 442.959; OM 442.989			01/89-08/94	10PA15C	R134a	DCP17033
3535 K	OM 402.982; OM 402.983			03/91-08/94	10PA15C	R134a	DCP17033
3535 K	OM 442.942; OM 442.945; OM 442.959; OM 442.966; OM 442.989			01/89-09/96	10PA15C	R134a	DCP17033
3535 S	OM 440.940; OM 442.944; OM 442.964			01/89-08/94	10PA15C	R134a	DCP17033
3538	OM 402.973; OM 402.978; OM 402.987			03/91-09/96	10PA15C	R134a	DCP17033
3538	OM 440.987; OM 446.926			03/91-09/96	10PA15C	R134a	DCP17033
3538	OM 440.990; OM 446.924; OM 446.926			09/91-09/96	10PA15C	R134a	DCP17033
3538 AK	OM 402.973; OM 402.978; OM 402.982; OM 402.983; OM 402.987			03/91-09/96	10PA15C	R134a	DCP17033
3538 AK	OM 440.970; OM 440.975; OM 440.979; OM 440.982; OM 440.983; OM 440.984; OM 440.985; OM 442.997; OM 446.926; OM 446.930; OM 446.931; OM 446.939; OM 446.940			03/91-09/96	10PA15C	R134a	DCP17033
3538 K	OM 402.973; OM 402.978; OM 402.982; OM 402.983; OM 402.987			03/91-09/96	10PA15C	R134a	DCP17033
3538 K	OM 440.970; OM 440.975; OM 440.979; OM 440.982; OM 440.983; OM 440.984; OM 442.989; OM 446.926; OM 446.930; OM 446.939; OM 446.940			03/91-09/96	10PA15C	R134a	DCP17033
3544	OM 440.970; OM 440.978; OM 446.922			01/92-09/96	10PA15C	R134a	DCP17033
3544 AK	OM 440.970; OM 440.980; OM 440.985			03/91-09/96	10PA15C	R134a	DCP17033
3544 K	OM 440.970			03/91-09/96	10PA15C	R134a	DCP17033
3548	OM 440.975; OM 442.993			05/92-09/96	10PA15C	R134a	DCP17033
3550	OM 440.975; OM 440.976; OM 442.993; OM 442.997			05/92-09/96	10PA15C	R134a	DCP17033
3550 K	OM 440.975; OM 440.982; OM 442.997			03/91-09/96	10PA15C	R134a	DCP17033
3550 S, 3553 S	OM 440.975; OM 442.993; OM 442.997			05/92-09/96	10PA15C	R134a	DCP17033
3553 S	OM 446.933			04/92-09/96	10PA15C	R134a	DCP17033
3553, 3553 L	OM 446.920			01/94-09/96	10PA15C	R134a	DCP17033
4050 A	OM 440.975			01/89-09/96	10PA15C	R134a	DCP17033
4050 A	OM 423.950			01/89-09/96	10PA15C	R134a	DCP17033
4844	OM 440.970; OM 440.979			12/91-08/94	10PA15C	R134a	DCP17033

				TYPE	GAS	DENSO PN	OE
<b>MERCEDES-BENZ CV</b> <i>Continued</i>							
<b>SK (87-96)</b> <i>Continued</i>							
4844 K	OM 440.984; OM 446.940		03/91-09/96	10PA15C	R134a	DCP17033	
4850 A	OM 423.950		01/89-09/96	10PA15C	R134a	DCP17033	
<b>UNIMOG (55-)</b>							
U 110,U 110L	OM 364.955; OM 364.958		02/92-	10PA15C	R134a	DCP17095	
U 130,U 140	OM 364.982; OM 364.985		07/92-	10PA15C	R134a	DCP17095	
U 140L	OM 364.985		07/92-	10PA15C	R134a	DCP17095	
U 140T	OM 364.982		07/92-	10PA15C	R134a	DCP17095	
U 300	OM 904.927;OM 904.928		03/00-	10PA15C	R134a	DCP17095	
<b>MG</b>							
<b>MG ZS (01-05)</b>							
180	25 KV6		07/01-10/05	7SBU16C	R134a	DCP14018	JPB101430A
<b>MG ZT (01-05)</b>							
1.8 16V	18 K4F		01/03-07/05	7SBU16C	R134a	DCP24004	
1.8 T 16V	18 K4G		01/03-07/05	7SBU16C	R134a	DCP24004	
2.0 CDTi	204D2		06/02-07/05	7SBU16C	R134a	DCP24005	
160	25 KV6		06/01-07/05	7SBU16C	R134a	DCP14018	JPB000040A
180	25 KV6		02/04-10/05	7SBU16C	R134a	DCP14018	JPB000040A
190	25 KV6		06/01-07/05	7SBU16C	R134a	DCP14018	JPB000040A
<b>MINI</b>							
<b>MINI (R50, R53) (01-06)</b>							
1.4 One D	1ND;W17 D14 (1ND)		06/03-09/06	5SA09C	R134a	DCP05022	64536922397
<b>MITSUBISHI</b>							
<b>CARISMA (95-06)</b>							
1.9 TD	F8QT		10/96-06/00	10S17C	R134a	DCP45009	MR568289
<b>COLT CZC (06-09)</b>							
1.5	4A91		05/06-07/08	5SE09C	R134a	DCP45003	7813A132
1.5 Turbo	4G15T		05/06-07/08	5SE09C	R134a	DCP45003	7813A132
<b>COLT VI (04-12)</b>							
1.1	3A91		10/04-09/08	5SE09C	R134a	DCP45003	7813A132
1.3	4A90	For cold climates;For mild climate zones	06/04-09/08	5SE09C	R134a	DCP17054	
1.3 LPG	4A90	For cold climates;For mild climate zones	06/04-09/08	5SE09C	R134a	DCP17054	
1.5	4A91		06/04-09/08	5SE09C	R134a	DCP45003	7813A132
1.5 CZT	4G15T		03/05-09/08	5SE09C	R134a	DCP45003	7813A132
1.5 DI-D	OM 639.939		08/04-09/08	5SE09C	R134a	DCP45003	7813A132
<b>PAJERO II (90-00)</b>							
2.8 D	4M40-T		11/93-10/99	10PA15VC	R134a	DCP45010	
2.8 TD	4M40-T		06/94-10/99	10PA15VC	R134a	DCP45010	
<b>PAJERO III (00-07)</b>							
3.2 DI-D	4M41		04/00-12/06	10S17C	R134a	DCP45009	MR568289; MR500876
3.5	6G74 (DOHC 24V)		04/00-10/06	10S17C	R134a	DCP45011	
3.5 V6 GDI	6G74 (GDI)		04/00-10/06	10S17C	R134a	DCP45011	MR500877
<b>PAJERO IV (06-)</b>							
3.2 DI-D	4M41		11/06-	10S17C	R134a	DCP45004	
3.2 DI-D	4M41	For vehicles with 2 zone automatic air conditioning	11/06-	10S17C	R134a	DCP45005	
3.2 DI-D 4WD	4M41		02/07-	10S17C	R134a	DCP45004	
3.2 DI-D 4WD	4M41	For vehicles with 2 zone automatic air conditioning	01/09-	10S17C	R134a	DCP45005	
3.2 DI-D GLS	4M41		02/07-	10S17C	R134a	DCP45004	
3.2 DI-D GLS	4M41	For vehicles with 2 zone automatic air conditioning	02/07-	10S17C	R134a	DCP45005	
3.2 TD 4WD	4M41		01/10-	10S17C	R134a	DCP45004	
3.2 TD 4WD	4M41	For vehicles with 2 zone automatic air conditioning	01/10-	10S17C	R134a	DCP45005	
3.8 V6	6G75		10/06-	10S17C	R134a	DCP45006	
3.8 V6	6G75-8		02/07-10/09	10S17C	R134a	DCP45013	
<b>MOSKVICH</b>							
<b>403 (62-68)</b>							
E 1.4			03/62-09/68	7SBU17A	R134a	DCP05096	





				TYPE	GAS	DENSO PN	OE
<b>NISSAN</b>							
<b>QASHQAI II (13-)</b>							
1.2 DIG-T	HR12DDT; HRA2DDT		11/13-	6SBH14C	R1234yf	DCP46020	
1.5 dCi	K9K 636; K9K 646		11/13-	6SBH14C	R1234yf	DCP46022	
1.6 dCi	R9M		11/13-	6SBH14C	R1234yf	DCP46020	
1.6 dCi 4x4	R9M		11/13-	6SBH14C	R1234yf	DCP46020	
1.6 DIG-T	MR16DDT		10/14-	6SBH14C	R134a; R1234yf	DCP46024	
<b>X-TRAIL (T32) (13-)</b>							
1.6 dCi	R9M		04/14-	6SBH14C	R134a; R1234yf	DCP46025	
1.6 dCi 4x4	R9M		04/14-	6SBH14C	R134a; R1234yf	DCP46025	
2.0	MR20DD		09/14-	6SBH14C	R1234yf	DCP46021	
2.0 dCi	M9R		10/16-04/17	6SBH14C	R134a; R1234yf	DCP46025	926004CA2A
2.0 dCi 4x4	M9R		10/16-04/17	6SBH14C	R134a; R1234yf	DCP46025	926004CA2A
<b>OPEL</b>							
<b>ASTRA G (98-09)</b>							
1.6 16V	C 16 SEL; X 16 XEL; Z 16 XE	Ch No: 12094026;1H0 01833>	02/98-02/04	7SBU16C	R134a	DCP20004	6854000
1.6 16V	X 16 XEL;Z 16 XE	For vehicles with front and rear air conditioning	02/98-10/05	7SBU16C	R134a	DCP20004	24416177
1.8 16V	X 18 XE1;Z 18 XE	For vehicles with front and rear air conditioning	02/98-02/04	7SBU16C	R134a	DCP20004	24416177
1.8 16V	Z 18 XE		09/00-10/05	7SBU16C	R134a	DCP20004	24416177
2.0 DI	X 20 DTL;Y 20 DTL		02/98-01/05	7SBU16C	R134a	DCP20005	6854001;1854 121
2.0 DTI 16V	X 20 DTH		08/99-07/04	7SBU16C	R134a	DCP20005	6854001;1854 121
2.2 DTI	Y 22 DTR		09/02-10/05	7SBU16C	R134a	DCP20005	24430319
2.2 DTI	Y 22 DTR	For vehicles with front and rear air conditioning	07/03-01/05	7SBU16C	R134a	DCP20005	
<b>COMBO D (12-)</b>							
1.4	A 14 FC;A 14 FP		02/12-	5SL12	R134a; R1234yf	DCP09062	
1.4 CNG	A 14 FC		02/12-	5SL12	R134a; R1234yf	DCP09062	
<b>CORSA D (06-14)</b>							
1.0	A 10 XEP;Z 10 XEP		07/06-08/14	5SL12C	R134a	DCP20021	
1.0	A 10 XEP;Z 10 XEP		07/06-08/14	5SL12C	R134a	DCP20021K	
1.2	A 12 XEL;A 12 XER;Z 12 XEP		07/06-08/14	5SL12C	R134a	DCP20021	
1.2	A 12 XEL;A 12 XER;Z 12 XEP		07/06-08/14	5SL12C	R134a	DCP20021K	
1.2 LPG	A 12 XER;Z 12 XEP		08/06-08/14	5SL12C	R134a	DCP20021	
1.2 LPG	A 12 XER;Z 12 XEP		08/06-08/14	5SL12C	R134a	DCP20021K	
1.3 CDTI	A 13 DTC;A 13 DTE;A 13 DTR;Z 13 DTE; Z 13 DTH;Z 13 DTJ		07/06-08/14	5SL12C	R134a	DCP20022	
1.4	A 14 NEL		07/12-08/14	5SL12C	R134a	DCP20021	
1.4	Z 14 XEP		07/06-08/14	5SL12C	R134a	DCP20021	
1.4	Z 14 XEP		07/06-08/14	5SL12C	R134a	DCP20021K	
1.4	A 14 XEL;A 14 XER		09/09-08/14	5SL12C	R134a	DCP20021	
1.4	A 14 XEL;A 14 XER		09/09-08/14	5SL12C	R134a	DCP20021K	
1.4 LPG	Z 14 XEP		08/06-12/11	5SL12C	R134a	DCP20021	
1.4 LPG	Z 14 XEP		08/06-12/11	5SL12C	R134a	DCP20021K	
1.4 LPG	A 14 XEL		09/09-08/14	5SL12C	R134a	DCP20021	
1.4 LPG	A 14 XEL		09/09-08/14	5SL12C	R134a	DCP20021K	
1.6 Turbo	A 16 LEL;A 16 LER;A 16 LES;Z 16 LEL; Z 16 LER		11/06-08/14	5SL12C	R134a	DCP20023	
1.7 CDTI	A 17 DTS;Z 17 DTR		08/06-08/14	5SL12C	R134a	DCP20022	
<b>CORSA E (14-)</b>							
1.0	B 10 XFL;B 10 XFT;D 10 XFL;F 10 XFL; F 10 XFT		09/14-	5SL12C	R134a; R1234yf	DCP20121	
1.2	B 12 XEL;B 12 XER		09/14-	5SL12C	R134a	DCP20021	
1.2	B 12 XEL;B 12 XER		09/14-	5SL12C	R134a	DCP20021K	
1.2	B 12 XEL;B 12 XER		09/14-	5SL12C	R134a; R1234yf	DCP20123	
1.3 CDTI	B 13 DTC;B 13 DTE;B 13 DTN;B 13 DTR		09/14-	5SL12C	R134a; R1234yf	DCP20120	
1.4	B 14 XEJ;B 14 XEL		09/14-	5SL12C	R134a	DCP20021	





				TYPE	GAS	DENSO PN	OE
<b>OPEL</b> <i>Continued</i>							
<b>CORSA E (14-)</b> <i>Continued</i>							
1.4	B 14 XEJ;B 14 XEL			09/14-	5SL12C	R134a	DCP20021K
1.4	B 14 XEJ;B 14 XEL			09/14-	5SL12C	R134a; R1234yf	DCP20123
1.4 LPG	B 14 XEL			03/15-	5SL12C	R134a	DCP20021
1.4 LPG	B 14 XEL			03/15-	5SL12C	R134a	DCP20021K
1.4 LPG	B 14 XEL			03/15-	5SL12C	R134a; R1234yf	DCP20123
1.4 Turbo	B 14 NEH;B 14 NEJ;D 14 NEH			09/14-	5SL12C	R134a; R1234yf	DCP20122
1.6 Turbo	B 16 LER; B 16 LES			03/15-	5SL12C	R134a	DCP20023
<b>MERIVA A (03-10)</b>							
1.6	Z 16 XEP			01/06-05/10	5SL12C	R134a	DCP20023
<b>OMEGA B (94-03)</b>							
2.5 D	X 25 DT; X 25 TD			05/94-05/99	7SBU16C	R134a	DCP20006
2.5 DTI	Y 25 DT;Y 25 TD			09/01-07/03	7SBU16C	R134a	DCP20030
2.5 TD	U 25 DT;U 25 TD;X 25 DT;X 25 TD			04/94-07/03	6CA17C	R134a	DCP20001
2.5 TD	U 25 DT;U 25 TD;X 25 DT;X 25 TD			04/94-07/03	7SBU16C	R134a	DCP20006
<b>VECTRA B (95-03)</b>							
2.5 i 500	X 25 XE			05/98-09/00	7SBU16C	R134a	DCP20003
2.5 i V6	X 25 XE			10/95-01/99	7SBU16C	R134a	DCP20003
2.6 i V6	Y 26 SE			09/00-07/03	7SBU16C	R134a	DCP20003
<b>ZAFIRA A (99-05)</b>							
1.6 16V	X 16 XEL; Z 16 XE			04/99-06/05	7SBU16C	R134a	DCP20004
1.6 CNG	Z 16 YNG			07/03-06/05	7SBU16C	R134a	DCP20004
1.8 16V	X 18 XE1;Z 18 XE			04/99-06/05	7SBU16C	R134a	DCP20004
2.0 DI 16V	X 20 DTL			07/99-06/05	7SBU16C	R134a	DCP20005
2.0 DTI 16V	Y 20 DTH	For vehicles with front and rear air conditioning		09/00-06/05	7SBU16C	R134a	DCP20005
2.2 16V	Z 22 SE			07/03-06/05	7SBU16C	R134a	DCP20004
2.2 DTI 16V	Y 22 DTR	For vehicles with front and rear air conditioning		07/03-06/05	7SBU16C	R134a	DCP20005
<b>PERODUA</b>							
<b>VIVA (07-)</b>							
0.66	EF-VE			07/07-06/14	SV07C	R134a	DCP99017
<b>PEUGEOT</b>							
<b>208 I (12-)</b>							
1.0	ZMZ (EB0)			03/12-	5SEL09C	R134a	DCP21015
1.2	HMZ (EB2); HMZ (EB2F)			03/12-	5SEL09C	R134a	DCP21015
1.2 GPL	HMZ (EB2F)			06/15-	5SEL12C	R1234yf	DCP21016
1.2 THP 110	HNP (EB2ADT); HNV (EB2DTM); HNZ (EB2DT)			07/14-	5SEL09C	R134a	DCP21015
1.2 THP 110	HNP (EB2ADT); HNV (EB2DTM); HNZ (EB2DT)			07/14-	5SEL12C	R1234yf	DCP21016
1.2 VTi 68 / PureTech 68	HMM (EB2FAD); HMP (EB2FB)			08/16-	5SEL12C	R1234yf	DCP21016
<b>308 CC (07-)</b>							
1.6 16V	5FT (EP6DT);5FV (EP6CDT);5FX (EP6DT)			06/09-12/14	5SEL12	R134a; R1234yf	DCP21021
1.6 THP	EP6CDTX	For hot climate zones		10/10-12/14	6SEL16C	R134a	DCP21014
2.0 HDi	RHF (DW10BTED4)			10/10-12/12	6SEL16C	R134a	DCP21014
2.0 HDi	RHH (DW10CTED4)	Ch No: 12383>		10/10-12/14	6SEL16C	R134a	DCP21014
<b>308 I (07-)</b>							
1.4 16V	8FR (EP3)	Ch No: 12383>		10/10-10/14	6SEL16C	R134a	DCP21014
1.4 16V	8FR (EP3);8FS (EP3);EP3			09/07-10/14	5SEL12	R134a; R1234yf	DCP21021
1.4 16V	8FS (EP3)			05/08-10/14	6SEL16C	R134a	DCP21014
1.4 16V	8FS (EP3); EP3	For hot climate zones		09/07-10/14	6SEL16C	R134a	DCP21014
1.6 16V	5FT (EP6DT)	For hot climate zones		09/07-10/14	6SEL16C	R134a	DCP21014
1.6 16V	5FT (EP6DT);5FV (EP6CDT);5FW (EP6);5FX (EP6DT);5FY (EP6DTS);EP6			09/07-10/14	5SEL12	R134a; R1234yf	DCP21021
1.6 16V	5FT (EP6DT);5FW (EP6);5FX (EP6DT);EP6			09/07-10/14	6SEL16C	R134a	DCP21014
1.6 16V	5FV (EP6CDT)	Ch No: 12383>		10/10-10/14	6SEL16C	R134a	DCP21014
1.6 16V	5FY (EP6DTS)	Ch No: >12193		03/08-10/14	6SEL16C	R134a	DCP21014
1.6 GTi	EP6CDTX			07/10-10/14	5SEL12	R134a; R1234yf	DCP21021

				TYPE	GAS	DENSO PN	OE
<b>PEUGEOT</b> <i>Continued</i>							
<b>308 I (07-)</b> <i>Continued</i>							
1.6 HDi	9HJ (DV6DTEDE);9HP (DV6DTEDE); 9HR (DV6C);9HV (DV6TED4B); 9HV (DV6TED4BU);9HX (DV6ATED4)	Ch No: 12383>	10/10-10/14	6SEL16C	R134a	DCP21014	6487 40
2.0 HDi	RHH (DW10CTED4)	Ch No: 12383>	10/10-10/14	6SEL16C	R134a	DCP21014	6487 40
<b>308 II (13-)</b>							
1.2 THP 110	HNP (EB2ADT);HNV (EB2DTM);HNZ (EB2DT)		11/13-	5SEL12C	R1234yf	DCP21016	9675659880
1.2 THP 130	HNY (EB2DTS)		11/13-	5SEL12C	R1234yf	DCP21016	9675659880
1.2 VTi 72	HMZ (EB2F)		09/13-	5SEL12C	R1234yf	DCP21016	9675659880
1.6	5FV (EP6CDT)	Ch No: >13567	09/13-	5SEL12C	R1234yf	DCP21017	
1.6 BlueHDi 100	BHY (DV6FD)		04/14-	5SEL12C	R1234yf	DCP21016	9675659880
1.6 BlueHDi 100	BHY (DV6FD)		04/14-	5SEL12C	R1234yf	DCP21017	9675659880
1.6 BlueHDi 120	BHZ (DV6FC)		11/13-	5SEL12C	R1234yf	DCP21016	9675659880
1.6 BlueHDi 120	BHZ (DV6FC)		11/13-	5SEL12C	R1234yf	DCP21017	9675659880
1.6 HDi	9HP (DV6DTEDE)		09/13-	5SEL12C	R1234yf	DCP21016	9675659880
1.6 HDi	9HP (DV6DTEDE)		09/13-	5SEL12C	R1234yf	DCP21017	9675659880
1.6 HDi / BlueHDi 115	9HC (DV6C);BHZ (DV6FC)		09/13-	5SEL12C	R1234yf	DCP21016	9675659880
1.6 HDi / BlueHDi 115	9HC (DV6C);BHZ (DV6FC)		09/13-	5SEL12C	R1234yf	DCP21017	9675659880
1.6 HDi 100	BHY (DV6FD)		04/14-	5SEL12C	R1234yf	DCP21016	9675659880
1.6 HDi 100	BHY (DV6FD)		04/14-	5SEL12C	R1234yf	DCP21017	9675659880
1.6 HDi 92	9HP (DV6DTEDE)		03/14-	5SEL12C	R1234yf	DCP21016	9675659880
1.6 HDi 92	9HP (DV6DTEDE)		03/14-	5SEL12C	R1234yf	DCP21017	9675659880
1.6 THP 125	5FA (EP6CDT)		03/14-	5SEL12C	R1234yf	DCP21017	9675659880
1.6 THP 125	5FA (EP6CDT)	Ch No: >13567	09/13-	5SEL12C	R1234yf	DCP21017	
1.6 THP 155	5FV (EP6CDT)		03/14-	5SEL12C	R1234yf	DCP21017	9675659880
2.0 BlueHDi 150	AHX (DW10FCD);AHX (DW10FD)		11/13-	5SEL12C	R1234yf	DCP21016	9675659880
2.0 BlueHDi 150	AHX (DW10FCD);AHX (DW10FD)		11/13-	5SEL12C	R1234yf	DCP21017	9675659880
<b>508 I (10-)</b>							
1.6 HDi	9HL (DV6C);9HR (DV6C)		11/10-12/18	5SEL12	R134a; R1234yf	DCP21021	9676862380
<b>2008 (13-)</b>							
1.2 THP 110 / PureTech 110	HNP (EB2ADT); HNV (EB2DTM); HNZ (EB2DT)		05/15-	5SEL12C	R1234yf	DCP21016	9675659880
1.2 THP 130 / PureTech 130	HNS (EB2ADTS); HNY (EB2DTS)		01/15-	5SEL12C	R1234yf	DCP21016	
1.2 VTi	HMZ (EB2); HMZ (EB2F)		04/13-	5SEL09C	R134a	DCP21015	
1.2 VTi	HMZ (EB2); HMZ (EB2F)	Ch No: OPR 14574>	03/13-	5SEL09	R134a; R1234yf	DCP21025	9822184980
<b>3008 (09-)</b>							
1.2	HNY (EB2DTS)		01/15-08/16	5SEL12	R134a; R1234yf	DCP21022	9802875780
1.6 BlueHDi 120	DV6F*		05/14-08/16	5SEL12	R134a; R1234yf	DCP21022	9802875780
1.6 HDi / BlueHDi 115	DV6F*		02/13-08/16	5SEL12	R134a; R1234yf	DCP21022	9802875780
1.6 THP	5FE (EP6CDTM);5FE (EP6CDTMD); 5FV (EP6CDT);5FX (EP6DT)		06/09-08/16	6SEL16C	R134a	DCP21014	6487 40
1.6 VTi	5FS (EP6C); 5FW (EP6); EP6		06/09-08/16	6SEL16C	R134a	DCP21014	6487 40
2.0 HDi	RHD (DW10CB)		09/11-08/16	5SEL12C	R1234yf	DCP21016	
2.0 HDi	RHH (DW10CTED4)		01/10-08/16	6SEL16C	R134a	DCP21014	6487 40
2.0 HDi 150 / BlueHDi 150	AHX (DW10FD); RHE (DW10CTED4)		06/09-08/16	5SEL12C	R1234yf	DCP21016	9675659880
<b>3008 SUV (16-)</b>							
1.5 BlueHDi 130	YHZ (DV5RC)		02/18-	5SEL12C	R134a; R1234yf	DCP21024	
1.6 BlueHDi 100	BHY (DV6FD)		11/16-	5SEL12C	R134a; R1234yf	DCP21023	
1.6 BlueHDi 115	BHX (DV6FC)		11/16-	5SEL12C	R134a; R1234yf	DCP21023	
1.6 BlueHDi 120	BHZ (DV6FC)		05/16-	5SEL12C	R134a; R1234yf	DCP21023	
1.6 THP 165	5GZ (EP6FDT)		05/16-	5SEL12C	R134a; R1234yf	DCP21023	
2.0 BlueHDi 136	AHV (DW10FD)		11/16-	5SEL12C	R134a; R1234yf	DCP21024	
2.0 BlueHDi 150	AHX (DW10FD)		05/16-	5SEL12C	R134a; R1234yf	DCP21024	
2.0 BlueHDi 180	AHW (DW10FC)		05/16-	5SEL12C	R134a; R1234yf	DCP21024	
<b>5008 I (09-)</b>							
1.2	HNY (EB2DTS)		01/15-03/17	5SEL12	R134a; R1234yf	DCP21022	9802875780
1.6 16V	5FS (EP6C);5FV (EP6CDT);5FW (EP6);EP6		09/09-03/17	6SEL16C	R134a	DCP21014	6487 40
1.6 BlueHDi 120	DV6F*		05/14-03/17	5SEL12	R134a; R1234yf	DCP21022	9802875780
1.6 THP 150	5FX (EP6DT)		02/12-03/17	6SEL16C	R134a	DCP21014	6487 40





				TYPE	GAS	DENSO PN	OE
<b>PEUGEOT</b> <i>Continued</i>							
<b>5008 I (09-)</b> <i>Continued</i>							
2.0 HDi 136 / BlueHDi 136	AHV (DW10FD); RHD (DW10CB); RHD (DW10CTED4)		02/12-03/17	5SEL12C	R1234yf	DCP21016	
<b>5008 II (16-)</b>							
1.6 BlueHDi 100	BHY (DV6FD)		12/16-	5SEL12C	R134a; R1234yf	DCP21023	
1.6 BlueHDi 115	BHX (DV6FC)		12/16-	5SEL12C	R134a; R1234yf	DCP21023	
1.6 BlueHDi 120	BHZ (DV6FC)		12/16-	5SEL12C	R134a; R1234yf	DCP21023	
1.6 THP 165	5GY (EP6FDTM); 5GZ (EP6FDT)		12/16-	5SEL12C	R134a; R1234yf	DCP21023	
2.0 BlueHDi 136	AHS (DW10FD); AHV (DW10FD)		12/16-	5SEL12C	R134a; R1234yf	DCP21024	
2.0 BlueHDi 150	AHX (DW10FD)		12/16-	5SEL12C	R134a; R1234yf	DCP21024	
2.0 BlueHDi 180	AHW (DW10FC)		12/16-	5SEL12C	R134a; R1234yf	DCP21024	
<b>PARTNER / RANCH (08-)</b>							
1.2 THP	DV6F*/EB2DT*		02/16-	5SEL12	R134a; R1234yf	DCP21022	9819714980
1.2 THP	HNV (EB2DTM);HNZ (EB2DT)		02/16-	5SEL12	R134a; R1234yf	DCP21021	
1.6	NFR (TU5JP4B);NFU (TU5JP4)		04/08-	5SEL12	R134a; R1234yf	DCP21021	
1.6	5FK (EP6CB)		11/10-	5SEL12	R134a; R1234yf	DCP21021	
1.6	5FS (EP6C)		04/10-	5SEL12	R134a; R1234yf	DCP21021	
1.6 BlueHDi 100	BHY (DV6FD)		12/14-	5SEL12	R134a; R1234yf	DCP21021	
1.6 BlueHDi 100	BHY (DV6FD);DV6F*/EB2DT*		04/15-	5SEL12	R134a; R1234yf	DCP21022	
1.6 BlueHDi 120	BHZ (DV6FC)		12/14-	5SEL12	R134a; R1234yf	DCP21021	
1.6 BlueHDi 120	BHZ (DV6FC);DV6F*/EB2DT*		12/14-	5SEL12	R134a; R1234yf	DCP21022	
1.6 HDi	9HF (DV6DTE);9HL (DV6C); 9HT (DV6BTED4);9HT (DV6BUTED4); 9HW (DV6BTED4);9HZ (DV6TED4)		04/08-	5SEL12	R134a; R1234yf	DCP21021	
1.6 HDi / BlueHDi 75	9HK (DV6ETEDM);9HN (DV6ETED); BHW (DV6FE)		06/08-	5SEL12	R134a; R1234yf	DCP21021	
1.6 HDi / BlueHDi 75	9HK (DV6ETEDM);9HN (DV6ETED); BHW (DV6FE);DV6F*/EB2DT*		06/08-	5SEL12	R134a; R1234yf	DCP21022	
1.6 HDi 16V	9HS (DV6TED4BU);9HV (DV6TED4B); 9HV (DV6TED4BU);9HX (DV6ATED4); 9HX (DV6AUTED4)		04/08-	5SEL12	R134a; R1234yf	DCP21021	
1.6 HDi 16V 4x4	9HS (DV6TED4BU);9HX (DV6ATED4); 9HX (DV6AUTED4)		04/12-	5SEL12	R134a; R1234yf	DCP21021	
1.6 HDi 90	9HJ (DV6DTE);9HP (DV6DTE)		04/10-	5SEL12	R134a; R1234yf	DCP21021	
1.6 VTi	NFR (TU5JP4B);NFU (TU5JP4)		04/08-	5SEL12	R134a; R1234yf	DCP21021	
1.6 VTi	NFU (TU5JP4)		09/08-	5SEL12	R134a; R1234yf	DCP21021	
1.6 VTi	5FK (EP6CB);5FS (EP6C)		09/09-	5SEL12	R134a; R1234yf	DCP21021	9676862380
<b>RCZ (10-)</b>							
1.6 16V	5FV (EP6CDT);EP6CDTX		03/10-12/15	5SEL12	R134a; R1234yf	DCP21021	9676862380
1.6 THP 150	5FE (EP6CDTMD)		03/11-12/15	5SEL12	R134a; R1234yf	DCP21021	9676862380
<b>PORSCHE</b>							
<b>911 (964) (88-94)</b>							
3.3 Turbo	M 30.69		08/90-07/92	10PA15C	R12 (Retrofit to R134a necessary!)	DCP28003	96412612101
3.3 Turbo S	M 30.69S		10/91-12/92	10PA15C	R12 (Retrofit to R134a necessary!)	DCP28003	96412612101
3.3 Turbo S	M 30.69S		08/92-12/92	10PA15C	R134a	DCP28004	96412612102
3.6 Carrera	M 64.01;M 64.02		07/89-05/94	10PA15C	R12 (Retrofit to R134a necessary!)	DCP28003	96412612101
3.6 Carrera	M 64.01;M 64.02		08/92-05/94	10PA15C	R134a	DCP28004	96412612102











				TYPE	GAS	DENSO PN	OE
<b>PORSCHE</b> <i>Continued</i>							
<b>911 (964) (88-94)</b> <i>Continued</i>							
3.6 Carrera 4	M 64.01		05/89-09/93	10PA15C	R12 (Retrofit to R134a necessary!)	DCP28003	96412612101
3.6 Carrera 4	M 64.01		08/92-05/94	10PA15C	R134a	DCP28004	96412612102
3.6 Carrera RS	M 64.03		06/91-07/92	10PA15C	R12 (Retrofit to R134a necessary!)	DCP28003	96412612101
3.6 Turbo	M 64.50		01/93-09/93	10PA15C	R134a	DCP28004	96412612102
<b>911 (991) (11-)</b>							
3.4 Carrera	MA1.04;MAB.04		12/11-12/16	7SEU17C	R134a	DCP28012	
3.4 Carrera 4	MA1.04;MAB.04		11/12-12/16	7SEU17C	R134a	DCP28012	
3.8 Carrera 4S	MA1.03;MAB.03		11/12-	7SEU17C	R134a	DCP28012	
3.8 Carrera 4S / 4 GTS	MA1.03		11/12-	7SEU17C	R134a	DCP28012	9A112601102
3.8 Carrera S	MA1.03;MAB.03		12/11-	7SEU17C	R134a	DCP28012	9A112601102
3.8 Carrera S / GTS	MA1.03		07/12-	7SEU17C	R134a	DCP28012	9A112601102
3.8 GT3	MA1.75		08/13-12/16	7SEU17C	R134a	DCP28012	
4.0 GT3 RS / R	MA1.76; MDG.GA		04/15-12/16	7SEU17C	R134a	DCP28012	
<b>911 (996) (97-05)</b>							
3.4 Carrera	M 96.01;M 96.02;M 96.04		09/97-08/05	7SBU16C	R134a	DCP28008	
3.4 Carrera 4	M 96.01;M 96.02;M 96.04		09/97-08/05	7SBU16C	R134a	DCP28008	
3.6	M 96.03		12/01-08/05	7SBU16C	R134a	DCP28008	
3.6 Carrera	M 96.03		10/01-08/05	7SBU16C	R134a	DCP28008	
3.6 Carrera 4	M 96.03		10/01-08/05	7SBU16C	R134a	DCP28008	
3.6 Carrera 4S	M 96.03		06/02-08/05	7SBU16C	R134a	DCP28008	
3.6 Carrera S	M 96.03		06/02-08/05	7SBU16C	R134a	DCP28008	
3.6 GT2	M 96.70		04/01-08/05	7SBU16C	R134a	DCP28008	
3.6 GT3	M 96.76;M 96.79		03/99-08/05	7SBU16C	R134a	DCP28008	996 126 011 52
3.6 S	M 96.70		08/04-08/05	7SBU16C	R134a	DCP28008	
3.6 Turbo 4	M 96.70		06/00-08/05	7SBU16C	R134a	DCP28008	
3.6 Turbo 4S	M 96.70		02/03-08/05	7SBU16C	R134a	DCP28008	
<b>911 (997) (04-12)</b>							
3.6 Carrera	M 96.05		07/04-12/08	7SBU16C	R134a	DCP28008	
3.6 Carrera	MA1.02		06/08-12/08	7SBU16C	R134a	DCP28008	
3.6 Carrera 4	M 96.05		07/04-12/08	7SBU16C	R134a	DCP28008	
3.6 Carrera 4	M 96.05		07/06-12/08	7SBU16C	R134a	DCP28008	
3.6 Carrera 4	MA1.02		06/08-12/08	7SBU16C	R134a	DCP28008	
3.6 GT 2	M 97.70S		09/07-12/09	7SBU16C	R134a	DCP28008	
3.6 GT 2	M 97.70S		01/10-12/12	7SEU17C	R134a	DCP28012	
3.6 GT2 RS	M 97.70		05/10-12/12	7SEU17C	R134a	DCP28012	
3.6 GT3	M 97.76		03/06-12/09	7SEU17C	R134a	DCP28016	
3.6 Turbo	M 97.70		03/06-12/09	7SBU16C	R134a	DCP28008	
3.8 Carrera 4 GTS	MA1.01		06/09-12/12	7SEU17C	R134a	DCP28012	9A112601102
3.8 Carrera 4S	MA1.01		06/08-12/12	7SEU17C	R134a	DCP28012	9A112601102
3.8 Carrera 4S	M 97.01		04/05-12/10	7SEU17C	R134a	DCP28016	
3.8 Carrera 4S	M 97.01;M 97.01S		07/04-12/08	7SBU16C	R134a	DCP28008	
3.8 Carrera GTS	MA1.01		06/09-12/11	7SEU17C	R134a	DCP28012	9A112601102
3.8 Carrera S	MA1.01		06/08-12/11	7SEU17C	R134a	DCP28012	9A112601102
3.8 Carrera S	M 97.01;M 97.01S		07/04-12/08	7SBU16C	R134a	DCP28008	
3.8 GT3	M 97.77		05/09-12/11	7SEU17C	R134a	DCP28016	
3.8 GT3 RS	M 97.77R		08/09-12/11	7SEU17C	R134a	DCP28016	
3.8 Turbo	MA1.70		09/09-12/12	7SEU17C	R134a	DCP28012	
3.8 Turbo S	MA1.70		02/10-12/12	7SEU17C	R134a	DCP28012	
4.0 GT3 RS	M 97.74		07/11-12/12	7SEU17C	R134a	DCP28012	
<b>928 (77-95)</b>							
5.4 GTS	M 28.49; M 28.50		07/92-11/95	10PA20C	R134a	DCP28006	92812611301
<b>944 (81-91)</b>							
2.5	M 44.01;M 44.02;M 44.03;M 44.04;M 44.05;M 44.06;M 44.07;M 44.08;M4409;M4410		01/85-12/90	10P15E	R12 (Retrofit to R134a necessary!)	DCP28001	94412600800
2.5 S	M 44.40		08/86-07/88	10P15E	R12 (Retrofit to R134a necessary!)	DCP28001	94412600800





				TYPE	GAS	DENSO PN	OE
<b>PORSCHE</b> <i>Continued</i>							
<b>944 (81-91)</b> <i>Continued</i>							
2.5 Turbo	M 44.50;M 44.51;M 44.52			08/85-07/91	10P15E	R12 (Retrofit to R134a necessary)	DCP28001 94412600800
2.7	M 44.11; M 44.12			11/88-08/89	10P15E	R12 (Retrofit to R134a necessary)	DCP28001 94412600800
3.0 S2	M 44.41			12/88-07/91	10P15E	R12 (Retrofit to R134a necessary)	DCP28001 94412600800
<b>968 (91-95)</b>							
3.0	M 44.43;M 44.44			06/91-07/92	10P15E	R12 (Retrofit to R134a necessary)	DCP28001 94412600800
<b>BOXSTER (986) (96-04)</b>							
2.5	M 96.20			09/96-08/99	7SBU16C	R134a	DCP28008
2.7	M 96.22;M 96.23			06/99-12/04	7SBU16C	R134a	DCP28008
3.2 S	M 96.21;M 96.24			08/99-12/04	7SBU16C	R134a	DCP28008
<b>BOXSTER (987) (04-11)</b>							
2.7	M 96.25;M 97.20			11/04-12/09	7SBU16C	R134a	DCP28008
2.9	MA1.20			06/09-03/12	7SEU17C	R134a	DCP28012 9A112601102
3.2 S	M 96.26			11/04-12/06	7SBU16C	R134a	DCP28008
3.4	MA1.21			06/10-12/11	7SEU17C	R134a	DCP28012 9A112601102
3.4 S	M 97.21;M 97.22			07/06-12/09	7SBU16C	R134a	DCP28008
3.4 S	MA1.21			06/09-12/11	7SEU17C	R134a	DCP28012 9A112601102
<b>CAYENNE (92A) (10-)</b>							
4.8 Turbo	M 48.52;MCF.TB			06/10-	7SEU17C	R134a; R1234yf	DCP28019
4.8 Turbo S	M 48.52;MCY.XA			10/12-	7SEU17C	R134a; R1234yf	DCP28019
<b>CAYENNE (955) (02-10)</b>							
3.0 TDI	M 05.9D			02/09-05/10	7SEU17C	R134a	DCP32022
3.2	M02.2Y			10/03-12/04	7SEU16C	R134a	DCP32052 955.126.011.00
4.5 S	M 48.00			03/03-12/06	7SEU17C	R134a	DCP28010 94812601100
4.5 Turbo	M 48.50			03/03-12/06	7SEU17C	R134a	DCP28010 94812601100
4.5 Turbo S	M 48.50S;M4850T			01/04-09/07	7SEU17C	R134a	DCP28010 94812601100
<b>CAYMAN (981) (13-)</b>							
2.7	MA1.22			03/13-	7SEU17C	R134a	DCP28012
3.4 GTS	MA1.23			02/14-	7SEU17C	R134a	DCP28012
3.4 S	MA1.23			03/13-	7SEU17C	R134a	DCP28012
<b>CAYMAN (987) (05-12)</b>							
2.7	M 97.20			07/06-12/09	7SBU16C	R134a	DCP28008
2.9	MA1.20			02/09-12/12	7SEU17C	R134a	DCP28012 9A112601102
3.4 R	MA1.21			02/11-12/12	7SEU17C	R134a	DCP28012 9A112601102
3.4 S	M 97.21			11/05-12/09	7SBU16C	R134a	DCP28008
3.4 S	MA1.21			02/09-06/13	7SEU17C	R134a	DCP28012 9A112601102
<b>MACAN (14-)</b>							
2.0	DLHB;MCN.CC;MCY.NA;MCY.NB;MCY.PA			07/14-	6SEU14C	R134a	DCP02097
3.0 GTS	MDC.NA			10/15-12/16	6SES14C	R134a	DCP28018
3.0 S	MCT.MA			02/14-12/16	6SES14C	R134a	DCP28018
3.0 S Diesel	MCT.BA;MCT.BB;MCT.BC			02/14-09/18	6SES14C	R134a	DCP02102
3.6 Turbo	MCT.LA			02/14-12/16	6SES14C	R134a	DCP28018
<b>PANAMERA (970) (09-)</b>							
3.6	M 46.20			05/10-07/13	7SEU17C	R134a	DCP28014 94812601103
3.6 4	M 46.40			05/10-07/13	7SEU17C	R134a	DCP28014 94812601103
4.8 4S	M 48.40			09/09-07/13	7SEU17C	R134a	DCP28014 948.126.011.03
4.8 GTS	M 48.40;MCX.PA;MCX.RA			01/12-10/16	7SEU17C	R134a	DCP28017 970.126.011.02
4.8 S	M 48.20			09/09-07/13	7SEU17C	R134a	DCP28014 948.126.011.03
4.8 Turbo	M 48.70			09/09-07/13	7SEU17C	R134a	DCP28014 948.126.011.03
4.8 Turbo	MCW.BA			01/14-10/16	7SEU17C	R134a	DCP28017 970.126.011.02
4.8 Turbo S	M 48.70			05/11-07/13	7SEU17C	R134a	DCP28014 948.126.011.03





				TYPE	GAS	DENSO PN	OE
<b>PORSCHE</b> <i>Continued</i>							
<b>PANAMERA (970) (09-)</b> <i>Continued</i>							
4.8 Turbo S	MCW.CA		07/13-10/16	7SEU17C	R134a	DCP28017	970.126.011.0 2
<b>RENAULT</b>							
<b>ESPACE V (15-)</b>							
1.6 dCi 130	R9M 409		06/15-	6SBH14C	R1234yf	DCP46020	
1.6 dCi 160	R9M 452		06/15-	6SBH14C	R1234yf	DCP46020	
1.6 TCe 200	M5M 450		02/15-	6SBH14C	R134a; R1234yf	DCP46024	
<b>Grand SCÉNIC III (09-)</b>							
1.2 TCe	H5F 400;H5F 404		04/12-05/14	6SBU16C	R134a	DCP23034	
1.2 TCe	H5F 400;H5F 404		05/14-	6SBH14C	R1234yf	DCP46020	
1.4 16V	H4J 700		02/09-	6SEL14C	R134a	DCP23032	
1.5 dCi	K9K 636		01/12-05/14	6SBL14C	R134a	DCP23035	
1.5 dCi	K9K 636; K9K 836; K9K 837		05/14-	6SBH14C	R1234yf	DCP46022	
1.5 dCi	K9K 830;K9K 832;K9K 836;K9K 837		02/09-	6SEL14C	R134a	DCP23030	
1.6 16V	K4M 858		02/09-	6SEL14C	R134a	DCP23030	
1.6 16V Bifuel	K4M 866		02/09-	6SEL14C	R134a	DCP23030	
1.6 dCi	R9M 402; R9M 404; R9M 414		04/11-01/12	6SEL14C	R134a	DCP23032	
1.6 dCi	R9M 402; R9M 404; R9M 414		01/12-05/14	6SBU16C	R134a	DCP23034	
1.6 dCi	R9M 402; R9M 404; R9M 414		05/14-	6SBH14C	R1234yf	DCP46020	
1.6 E85	K4M 866		02/09-	6SEL14C	R134a	DCP23030	
1.9 dCi	F9Q 870; F9Q 872		02/09-	6SEL14C	R134a	DCP23031	
2.0 dCi	M9R 610;M9R 615		02/09-	6SEL14C	R134a	DCP23032	
<b>KADJAR (15-)</b>							
1.2 TCe 130	H5F 408		06/15-	6SBH14C	R1234yf	DCP46020	
1.5 dCi 110	K9K 646; K9K 647; K9K 649		06/15-	6SBH14C	R1234yf	DCP46022	
1.6 dCi 130	R9M 414		06/15-	6SBH14C	R1234yf	DCP46020	
1.6 dCi 130 4x4	R9M 414		06/15-	6SBH14C	R1234yf	DCP46020	
<b>KOLEOS II (16-)</b>							
1.6 dCi 130	R9M 409; R9M 414		08/16-	6SBH14C	R1234yf	DCP46020	
2.0 dCi 175	M9R 868		08/16-	6SBH14C	R1234yf	DCP46020	
<b>MEGANE CC (10-)</b>							
1.2 TCe	H5F 404		01/13-05/14	6SBU16C	R134a	DCP23034	
1.2 TCe	H5F 404		05/14-	6SBH14C	R1234yf	DCP46020	
1.4 TCe	H4J 700		06/10-	6SEL14C	R134a	DCP23032	
1.5 dCi	K9K 837		06/10-	6SEL14C	R134a	DCP23030	
1.6 16V	K4M 858		06/10-	6SEL14C	R134a	DCP23030	
1.6 dCi	R9M 402		04/11-05/14	6SBU16C	R134a	DCP23034	
1.6 dCi	R9M 402		05/14-	6SBH14C	R1234yf	DCP46020	
1.9 dCi	F9Q 870		06/10-	6SEL14C	R134a	DCP23031	
2.0 dCi	M9R 610		06/10-	6SEL14C	R134a	DCP23032	
2.0 TCe	F4R 870; F4R 872		06/10-	6SEL14C	R134a	DCP23031	
<b>MEGANE III (08-)</b>							
1.2 TCe	H5F 404;H5F 405;H5F 412		01/13-05/14	6SBU16C	R134a	DCP23034	
1.2 TCe	H5F 404;H5F 405;H5F 412		05/14-	6SBH14C	R1234yf	DCP46020	
1.2 TCe	H5F 400;H5F 408		03/12-05/14	6SBU16C	R134a	DCP23034	
1.2 TCe	H5F 400;H5F 408		05/14-	6SBH14C	R1234yf	DCP46020	
1.4 TCe	H4J 700		04/09-	6SEL14C	R134a	DCP23032	
1.5 dCi	K9K 636		01/12-05/14	6SBL14C	R134a	DCP23035	
1.5 dCi	K9K 636;K9K 836;K9K 837;K9K 846		05/14-	6SBH14C	R1234yf	DCP46022	
1.5 dCi	K9K 830;K9K 832;K9K 834;K9K 836; K9K 837;K9K 846		11/08-	6SEL14C	R134a	DCP23030	
1.6 16V	K4M 848;K4M 858		11/08-	6SEL14C	R134a	DCP23030	
1.6 16V BiFuel	K4M 858;K4M 866		11/08-	6SEL14C	R134a	DCP23030	
1.6 BiFuel	K4M 866		06/09-	6SEL14C	R134a	DCP23030	
1.6 dCi	R9M 402;R9M 404;R9M 414		04/12-05/14	6SBU16C	R134a	DCP23034	
1.6 dCi	R9M 402;R9M 404;R9M 414		05/14-	6SBH14C	R1234yf	DCP46020	
1.9 dCi	F9Q 872		11/08-	6SEL14C	R134a	DCP23031	
2.0 dCi	M9R 610;M9R 615		04/09-	6SEL14C	R134a	DCP23032	
2.0 R.S.	F4R 874		11/08-	6SEL14C	R134a	DCP23031	
2.0 TCe	F4R 870;F4R 872;F4R 874		11/08-	6SEL14C	R134a	DCP23031	
2.0 TCe 220	F4R 874		11/13-	6SEL14C	R134a	DCP23031	
<b>SCÉNIC III (09-)</b>							
1.2 TCe	H5F 400;H5F 404;H5F 408		04/12-05/14	6SBU16C	R134a	DCP23034	
1.2 TCe	H5F 400;H5F 404;H5F 408		05/14-	6SBH14C	R1234yf	DCP46020	
1.4 16V	H4J 700		06/09-	6SEL14C	R134a	DCP23032	
1.5 dCi	K9K 636		01/12-05/14	6SBL14C	R134a	DCP23035	
1.5 dCi	K9K 636; K9K 656; K9K 657; K9K 836; K9K 837		05/14-	6SBH14C	R1234yf	DCP46022	

				TYPE	GAS	DENSO PN	OE
<b>RENAULT</b> <i>Continued</i>							
<b>SCÉNIC III (09-)</b> <i>Continued</i>							
1.5 dCi	K9K 830;K9K 832;K9K 836;K9K 837;K9K 846			04/09-	6SEL14C	R134a	DCP23030
1.6 16V	K4M 858; K4M R 858			06/09-	6SEL14C	R134a	DCP23030
1.6 16V Bifuel	K4M 866			02/09-	6SEL14C	R134a	DCP23030
1.6 dCi	R9M 402; R9M 404; R9M 414			04/11-01/12	6SEL14C	R134a	DCP23032
1.6 dCi	R9M 402; R9M 404; R9M 414			01/12-05/14	6SBU16C	R134a	DCP23034
1.6 dCi	R9M 402; R9M 404; R9M 414			05/14-	6SBH14C	R1234yf	DCP46020
1.6 E85	K4M 866			06/09-	6SEL14C	R134a	DCP23030
1.9 dCi	F9Q 870; F9Q 872			06/09-	6SEL14C	R134a	DCP23031
2.0 dCi	M9R 610;M9R 615			02/09-	6SEL14C	R134a	DCP23032
<b>TALISMAN (15-)</b>							
1.5 dCi 110	K9K 646;K9K 647			11/15-	6SBH14C	R1234yf	DCP46022
1.6 dCi 130	R9M 409			11/15-	6SBH14C	R1234yf	DCP46020
1.6 dCi 160	R9M 452;R9M 453			06/15-	6SBH14C	R1234yf	DCP46020
1.6 TCe 150	M5M 450			11/15-	6SBH14C	R134a; R1234yf	DCP46024
1.6 TCe 200	M5M 450			11/15-	6SBH14C	R134a; R1234yf	DCP46024
<b>VEL SATIS (02-)</b>							
3.0 dCi	P9X 701;P9X 715			06/02-	6SBU16C	R134a	DCP23025
<b>RENAULT TRUCKS</b>							
<b>MASCOTT (99-13)</b>							
90	8140.63.2585			01/99-12/01	SC08C	R134a	DCP23002
90.35	8140.63.2585			01/99-12/01	SC08C	R134a	DCP23002
110	8140.43.B.3586; 8140.43.B.3588; 8140.43.C.2586			01/99-06/04	SC08C	R134a	DCP23002
110.35	8140.43.B.3586; 8140.43.B.3588; 8140.43.C.2586			01/99-06/04	SC08C	R134a	DCP23002
110.50	8140.43.B.3586; 8140.43.B.3588; 8140.43.C.2586			01/99-06/04	SC08C	R134a	DCP23002
110.55	8140.43.B.3586; 8140.43.B.3588; 8140.43.C.2586			01/99-06/04	SC08C	R134a	DCP23002
130	8140.43.S.2585; 8140.43.S.3585			01/99-06/04	SC08C	R134a	DCP23002
130.35	8140.43.S.2585; 8140.43.S.3585			01/99-06/04	SC08C	R134a	DCP23002
130.55	8140.43.S.2585; 8140.43.S.3585			01/99-06/04	SC08C	R134a	DCP23002
140	8140.43K			01/01-06/04	SC08C	R134a	DCP23002
140.35	8140.43K			01/01-06/04	SC08C	R134a	DCP23002
140.55	8140.43K			01/01-06/04	SC08C	R134a	DCP23002
150.35	8140.43N.3585			10/01-06/04	SC08C	R134a	DCP23002
150.55	8140.43N.3585			10/01-06/04	SC08C	R134a	DCP23002
150.65	8140.43N.3585			10/01-06/04	SC08C	R134a	DCP23002
<b>ROVER</b>							
<b>45 (00-05)</b>							
2.0 V6	20K4F			02/00-05/04	7SBU16C	R134a	DCP14018
<b>75 (99-05)</b>							
1.8	K 1.8			02/99-05/05	7SBU16C	R134a	DCP24004
1.8 Turbo	18 K4G			05/03-05/05	7SBU16C	R134a	DCP24004
2.0 CDT	M 47 R			08/01-06/04	7SBU16C	R134a	DCP24005
2.0 CDT	204D2; M47 D20 (204D1)			02/99-06/04	7SBU16C	R134a	DCP24005
2.0 CDTi	204D2			02/03-05/05	7SBU16C	R134a	DCP24005
2.0 V6	20K6F			02/99-06/04	7SBU16C	R134a	DCP14018
2.5 V6	25KV6;KV 6			02/99-05/05	7SBU16C	R134a	DCP14018
<b>800 (86-99)</b>							
825 D/SD	97A			06/92-06/98	6CA17A	R134a	DCP24001
825 SD	33B01			09/93-06/98	6CA17A	R134a	DCP24001
<b>SAAB</b>							
<b>9-5 (97-09)</b>							
2.0 t	B205E;B205L			09/97-12/04	7SBU16C	R134a	DCP25001
2.0 Turbo SE	B205E			10/98-07/00	7SBU16C	R134a	DCP25001
2.2 TiD	D223L			03/02-01/05	7SBU16C	R134a	DCP25001
2.3 t	B235E			09/97-12/04	7SBU16C	R134a	DCP25001
2.3 Turbo	B235L;B235R			10/99-01/05	7SBU16C	R134a	DCP25001
3.0 TiD	D308L	Ch No: >33010532		07/01-12/09	7SBU16C	R134a	DCP25001
3.0 V6t	B308E			01/98-12/03	7SBU16C	R134a	DCP25001
<b>SEAT</b>							
<b>ALHAMBRA (710) (10-)</b>							
1.4 TSI	CAVA; CNWB			06/10-	7SEU17C	R134a	DCP32045
1.4 TSI	CZDA; DJKA			05/15-	7SEU17C	R134a	DCP32045





				TYPE	GAS	DENSO PN	OE
<b>SEAT</b> <i>Continued</i>							
<b>ALHAMBRA (710) (10-)</b> <i>Continued</i>							
1.8 TSI	CDAА		11/12-	7SEU17C	R134a	DCP32045	
2.0 TDI	CFFA;CFFB;CFFE;CFGB;CFGC;CUVA;CUV C; CUWA;DFLA;DFMA;DLTA;DLUB		06/10-	7SEU17C	R134a	DCP32045	
2.0 TDI 4Drive	CFFB;CUVC;DFLA;DFMA		05/11-	7SEU17C	R134a	DCP32045	
2.0 TSI	CCZA;DEDA		11/10-	7SEU17C	R134a	DCP32045	
<b>ALTEA (XL) (5P) (04-)</b>							
1.2 TSI	CBZB		04/10-	6SEU14C	R134a	DCP02050	
1.4 16V	BXW	For cold climates;For mild climate zones	05/06-03/09	6SEU14C	R134a	DCP02030	
1.4 16V	BXW	For hot climate zones	05/06-03/09	7SEU17C	R134a	DCP32045	
1.4 TSI	CAXC		11/07-03/09	7SEU17C	R134a	DCP32045	
1.6	BGU;BSE;BSF;CCSA;CMXA	For cold climates;For mild climate zones	05/05-03/09	6SEU14C	R134a	DCP02030	
1.6	BGU;BSE;BSF;CCSA;CMXA	For hot climate zones	05/05-03/09	7SEU17C	R134a	DCP32045	
1.6 LPG	CHGA	For hot climate zones	09/09-	7SEU17C	R134a	DCP32045	
1.6 Multifuel	CCSA		10/06-	6SEU14C	R134a	DCP02030	
1.6 TDI	CAYB;CAYC	For hot climate zones	10/09-	7SEU17C	R134a	DCP32045	
1.6 TDI	CAYC	For cold climates;For mild climate zones	10/09-	6SEU14C	R134a	DCP02050	
1.8 TFSI	BYT	For hot climate zones	01/07-06/07	7SEU17C	R134a	DCP32045	
1.8 TFSI	BYT; BZB; CDAА		06/07-03/09	6SEU14C	R134a	DCP02050	
1.8 TFSI	BYT; BZB; CDAА	For cold climates;For mild climate zones	06/07-03/09	6SEU14C	R134a	DCP02050	
1.9 TDI	BJB;BKC;BLS;BXE		04/04-	7SEU17C	R134a	DCP32045	
1.9 TDI	BXF		08/09-	6SEU14C	R134a	DCP02050	
2.0 FSI	BLR;BLY;BVY;BVZ		05/04-03/09	7SEU17C	R134a	DCP32045	
2.0 TDI	AZV;BKD;BMN;CEGA		03/04-	7SEU17C	R134a	DCP32045	
2.0 TDI 4x4	BMN		06/07-03/09	7SEU17C	R134a	DCP32045	
2.0 TDI 4x4	CFHC	For cold climates	10/10-	6SEU14C	R134a	DCP02050	
2.0 TDI 4x4	CFHC	For hot climate zones	10/10-	7SEU17C	R134a	DCP32045	
2.0 TDI 8V	BMM		11/05-03/09	7SEU17C	R134a	DCP32045	
2.0 TDI 8V 4x4	BMM	For hot climate zones	06/07-03/09	7SEU17C	R134a	DCP32045	
2.0 TFSI	BWA		04/06-05/09	7SEU17C	R134a	DCP32045	
2.0 TFSI	BWA	For cold climates	10/06-05/09	6SEU14C	R134a	DCP02050	
2.0 TFSI	BWA	For hot climate zones	10/06-05/09	7SEU17C	R134a	DCP32045	
2.0 TFSI 4x4	BWA		06/07-05/09	7SEU17C	R134a	DCP32045	
2.0 TFSI 4x4	CCZB	For cold climates	05/09-	6SEU14C	R134a	DCP02050	
2.0 TFSI 4x4	CCZB	For hot climate zones	05/09-	7SEU17C	R134a	DCP32045	
<b>ARONA (KJ7) (17-)</b>							
1.0 TSI	CHZJ;CHZL;DKJA;DKLA;DKRF		07/17-	6SES14C	R134a; R1234yf	DCP32080	
1.5 TSI	DADA; DPCA		07/17-	6SES14C	R134a; R1234yf	DCP32080	
1.6 TDI	DGTA;DGTD		07/17-	6SES14C	R134a; R1234yf	DCP32080	
<b>ATECA (KH7) (16-)</b>							
1.0 TSI	CHZJ; DKRF		05/16-	6SES14C	R134a; R1234yf	DCP32080	
1.4 TSI	CZEA		06/16-	6SES14C	R134a; R1234yf	DCP32080	
1.4 TSI 4Drive	CZEA		06/16-	6SES14C	R134a; R1234yf	DCP32080	
1.6 TDI	DDYA; DGTE		04/16-	6SES14C	R134a; R1234yf	DCP32080	
2.0 TDI	CRVA;CRVC;DFFA		04/16-	6SES14C	R134a; R1234yf	DCP32080	
2.0 TDI 4Drive	DFFA;DFHA		04/16-	6SES14C	R134a; R1234yf	DCP32080	





				TYPE	GAS	DENSO PN	OE
<b>SEAT</b> <i>Continued</i>							
<b>ATECA (KH7) (16-) Continued</b>							
2.0 TSI 4Drive	CZPB; DKZA		05/17-	6SES14C	R134a; R1234yf	DCP32080	
<b>CORDOBA (6K2) (99-02)</b>							
1.4 16V	APE; AUA		05/00-10/02	6SEU12C	R134a	DCP27001	
1.9 SDI	AGP; AQM		06/99-10/02	6SEU12C	R134a	DCP27001	
<b>CORDOBA (6L) (02-09)</b>							
1.2	AZQ		10/02-04/04	6SEU12C	R134a	DCP27002	6Q0820803G
1.2	AZQ		10/02-04/04	6SEU14C	R134a	DCP32005	6Q0820803K
1.2	AZQ		10/02-04/04	6SEU14C	R134a	DCP32020	6Q0820803J
1.2 12V	BXV		05/06-11/09	6SEU14C	R134a	DCP32020	
1.4 16V	BBY;BBZ		09/02-11/09	6SEU12C	R134a	DCP27001	6Q0820803D
1.4 16V	BBZ;BKY;BXW		10/02-11/09	6SEU14C	R134a	DCP32020	6Q0820803J
1.4 16V	BKY		05/04-12/07	6SEU12C	R134a	DCP27002	6Q0820803G
1.4 16V	BKY		05/04-12/07	6SEU14C	R134a	DCP32005	6Q0820803K
1.4 TDI	AMF		10/02-12/05	6SEU12C	R134a	DCP27001	6Q0820803D
1.4 TDI	AMF;BMS;BNM;BNV		07/04-11/09	6SEU14C	R134a	DCP32020	6Q0820803J
1.6	BAH		04/03-07/04	6SEU12C	R134a	DCP27001	6Q0820803D
1.6	BAH		05/04-11/09	6SEU14C	R134a	DCP32020	6Q0820803J
1.6 16V	BTS		11/06-11/09	6SEU14C	R134a	DCP32020	
1.9 SDI	ASY		09/02-12/05	6SEU12C	R134a	DCP27001	6Q0820803D
1.9 SDI	ASY		07/04-12/05	6SEU14C	R134a	DCP32020	6Q0820803J
1.9 TDI	ASZ;ATD		09/02-09/05	6SEU12C	R134a	DCP27001	6Q0820803D
1.9 TDI	ASZ;ATD;AXR;BLT;BMT		07/04-11/09	6SEU14C	R134a	DCP32020	6Q0820803J
2.0	AZL; BBX		09/02-11/06	6SEU12C	R134a	DCP27001	6Q0820803D
2.0	AZL; BBX		09/02-11/09	6SEU14C	R134a	DCP32020	6Q0820803J
<b>EXEO (3R) (08-)</b>							
1.6	ALZ		03/09-09/10	6SEU14C	R134a	DCP02041	
1.8 T	CFMA		12/08-05/10	6SEU14C	R134a	DCP02041	
1.8 TSI	CDHA;CDHB		05/10-05/13	6SEU14C	R134a	DCP02041	
2.0 TDI	CAGA;CAGC;CAHA;CGLB;CJCA;CJCC		12/08-05/13	6SEU14C	R134a	DCP02042	
2.0 TFSI	BWE;CDND		03/09-05/13	6SEU14C	R134a	DCP02041	
<b>IBIZA II (6K1) (93-99)</b>							
1.4 i 16V	AFH; AQQ; AUB		06/97-02/02	6SEU12C	R134a	DCP27001	
<b>IBIZA II (6K2) (99-02)</b>							
1.4 16V	APE; AUA		05/00-02/02	6SEU12C	R134a	DCP27001	
1.9 SDI	AGP; AQM		08/99-02/02	6SEU12C	R134a	DCP27001	
<b>IBIZA III (6L) (02-09)</b>							
1.2	AZQ; BME		02/02-06/06	6SEU12C	R134a	DCP27002	6Q0820803G
1.2	AZQ; BME		02/02-06/06	6SEU14C	R134a	DCP32020	6Q0820803J
1.2	AZQ;BBM;BME		02/02-05/08	6SEU14C	R134a	DCP32005	6Q0820803K
1.2 12V	BXV		07/07-11/09	6SEU14C	R134a	DCP32005	
1.4 16V	AUB;BBY;BBZ		02/02-11/09	6SEU12C	R134a	DCP27001	6Q0820803D
1.4 16V	AUB;BBY;BBZ;BKY;BXW		02/02-11/09	6SEU14C	R134a	DCP32020	6Q0820803J
1.4 16V	BKY		05/04-03/05	6SEU12C	R134a	DCP27002	6Q0820803G
1.4 16V	BKY		05/04-03/05	6SEU14C	R134a	DCP32005	6Q0820803K
1.4 TDI	AMF		05/02-12/05	6SEU12C	R134a	DCP27001	6Q0820803D
1.4 TDI	AMF;BNM;BNV		05/02-11/09	6SEU14C	R134a	DCP32020	6Q0820803J
1.4 TDI	BMS		06/06-11/09	6SEU14C	R134a	DCP32005	6Q0820803K
1.6	BAH		02/03-04/04	6SEU12C	R134a	DCP27001	6Q0820803D
1.6	BAH		02/03-11/09	6SEU14C	R134a	DCP32020	6Q0820803J
1.6 16V	BTS		11/06-11/09	6SEU14C	R134a	DCP32020	
1.8 T Cupra R	BBU		05/04-02/08	6SEU12C	R134a	DCP27001	6Q0820803D
1.8 T Cupra R	BBU		05/04-02/08	6SEU14C	R134a	DCP32020	6Q0820803J
1.8 T FR	BJX		12/03-05/08	6SEU12C	R134a	DCP27001	6Q0820803D
1.8 T FR	BJX; BKV		12/03-05/08	6SEU14C	R134a	DCP32020	6Q0820803J
1.9 SDI	ASY		02/02-12/05	6SEU12C	R134a	DCP27001	6Q0820803D
1.9 SDI	ASY		02/02-12/05	6SEU14C	R134a	DCP32020	6Q0820803J
1.9 TDI	ASZ;ATD		02/02-09/05	6SEU12C	R134a	DCP27001	6Q0820803D
1.9 TDI	ASZ;ATD;AXR;BLT;BMT		02/02-11/09	6SEU14C	R134a	DCP32020	6Q0820803J
1.9 TDI Cupra R	BPX		03/04-11/05	6SEU12C	R134a	DCP27001	6Q0820803D
1.9 TDI Cupra R	BPX;BUK		03/04-02/08	6SEU14C	R134a	DCP32020	6Q0820803J
2.0	AZL		04/02-06/05	6SEU12C	R134a	DCP27001	6Q0820803D
2.0	AZL		04/02-06/05	6SEU14C	R134a	DCP32020	6Q0820803J
<b>IBIZA IV (6J, 6P) (08-)</b>							
1.0	CHYB		05/15-	6SES14C	R134a	DCP32060	
1.0 TSI	CHZB;CHZC		05/15-	6SES14C	R134a	DCP32060	
1.2	BZG;CGPA;CGPB;CJLB		03/08-	6SEU14C	R134a	DCP32005	6Q0820803K
1.2 TDI	CFWA		04/10-	6SEU14C	R134a	DCP02050	

				TYPE	GAS	DENSO PN	OE
<b>SEAT</b> <i>Continued</i>							
<b>IBIZA IV (6J, 6P) (08-)</b> <i>Continued</i>							
1.2 TSI	CBZA;CBZB		09/10-	6SEU14C	R134a	DCP02050	
1.2 TSI 16V	CJZC;CJZD		05/15-	6SES14C	R134a	DCP32060	
1.4	BXW;CGGB		03/08-	6SEU14C	R134a	DCP32020	6Q0820803J
1.4 TDI	BMS		07/08-06/10	6SEU14C	R134a	DCP32005	6Q0820803K
1.4 TDI	CUSA;CUSB;CUTA;CYZA		05/15-	6SES14C	R134a	DCP32060	
1.4 TSI	CAVF		06/09-03/12	6SEU14C	R134a	DCP02050	1K0820808A
1.4 TSI	CAVF;CNUB;CTHF;CTJB		02/12-	6SEU14C	R134a	DCP02030	
1.4 TSI	CPTA		10/13-	6SEU14C	R134a	DCP02030	
1.4 TSI	CZEA		11/15-	6SES14C	R134a	DCP32060	
1.4 TSI Cupra	CAVE; CTHE; CTJC		06/09-03/12	6SEU14C	R134a	DCP02050	1K0820808A
1.4 TSI Cupra	CAVE; CTHE; CTJC		06/09-	6SEU14C	R134a	DCP02030	
1.6	BTS		05/08-	6SEU14C	R134a	DCP32020	
1.6 LPG	CNKA		05/11-	6SEU12C	R134a	DCP27001	
1.6 TDI	CAYB;CAYC;CLNA		05/09-03/12	6SEU14C	R134a	DCP32020	
1.6 TDI	CAYC; CLNA		03/10-	6SEU14C	R134a	DCP02050	
1.8 TSI Cupra	DAJA		11/15-	6SES14C	R134a	DCP32060	
1.9 TDI	BLS		03/08-06/10	6SEU14C	R134a	DCP32020	
1.9 TDI	BXJ		07/08-06/10	6SEU14C	R134a	DCP32005	
2.0	CEKA		10/08-	6SEU12C	R134a	DCP27001	
2.0 TDI	CFHD		01/10-	6SEU14C	R134a	DCP02050	
<b>IBIZA V (KJ1) (17-)</b>							
1.0	CHYB;CHYC;DFNB		01/17-	6SES14C	R134a; R1234yf	DCP32080	
1.0 TGI	DBYA		11/17-	6SES14C	R134a; R1234yf	DCP32080	
1.0 TSI	CHZJ;CHZL;DKJA;DKLA;DKRF		01/17-	6SES14C	R134a; R1234yf	DCP32080	
1.5 TSI	DADA		07/17-	6SES14C	R134a; R1234yf	DCP32080	
1.6 TDI	DGTC;DGLD		09/17-	6SES14C	R134a; R1234yf	DCP32080	
<b>LEON (1M) (99-06)</b>							
1.6	BFQ; BGU		10/05-06/06	6SEU14C	R134a	DCP02030	
<b>LEON (1P) (05-12)</b>							
1.2 TSI	CBZB		02/10-12/12	6SEU14C	R134a	DCP02050	
1.4 16V	BXW		06/06-11/06	7SEU17C	R134a	DCP32045	
1.4 TSI	CAXC		11/07-09/08	7SEU17C	R134a	DCP32045	
1.6	BSE; BSF		07/05-05/10	7SEU17C	R134a	DCP32045	
1.6 LPG	CHGA		12/09-12/12	6SEU14C	R134a	DCP02030	
1.6 MultiFuel	BSE; CMXA		11/10-12/12	6SEU14C	R134a	DCP02030	
1.6 TDI	CAYB;CAYC	For cold climates;For mild climate zones	02/10-12/12	6SEU14C	R134a	DCP02050	
1.6 TDI	CAYB;CAYC	For hot climate zones	02/10-12/12	7SEU17C	R134a	DCP32045	
1.8 TSI	BZB; CDA A	For cold climates;For mild climate zones	06/07-12/12	6SEU14C	R134a	DCP02050	
1.8 TSI	BZB; CDA A	For hot climate zones	06/07-12/12	7SEU17C	R134a	DCP32045	
1.9 TDI	BKC;BLS;BXE;BXF	For cold climates	07/05-12/10	6SEU14C	R134a	DCP02050	
1.9 TDI	BKC;BLS;BXE;BXF	For mild climate zones; For hot climates	07/05-12/10	7SEU17C	R134a	DCP32045	
2.0 Cupra R	CDLA		09/09-12/12	7SEU17C	R134a	DCP32045	
2.0 FSI	BLR; BLY; BVY; BVZ		07/05-09/08	7SEU17C	R134a	DCP32045	
2.0 TDI	AZV;BKD;BMN;CEGA;CFJA		07/05-05/10	7SEU17C	R134a	DCP32045	
2.0 TDI	BMN; CEGA; CFJA	For cold climates	04/09-12/12	6SEU14C	R134a	DCP02050	
2.0 TDI	BMN; CEGA; CFJA	For mild climate zones; For hot climates	04/09-12/12	7SEU17C	R134a	DCP32045	
2.0 TDI 8V	BMM		10/05-05/10	7SEU17C	R134a	DCP32045	
2.0 TDI 8V	BMM	For cold climates	05/10-10/10	6SEU14C	R134a	DCP02050	
2.0 TDI 8V	BMM	For mild climate zones; For hot climates	05/10-10/10	7SEU17C	R134a	DCP32045	
2.0 TFSI	BWA1		05/05-09/08	7SEU17C	R134a	DCP32045	

				TYPE	GAS	DENSO PN	OE
<b>SEAT</b> <i>Continued</i>							
<b>LEON (1P) (05-12)</b> <i>Continued</i>							
2.0 TFSI	BWJ	For cold climates;For mild climate zones	11/06-05/11	6SEU14C	R134a	DCP02030	
2.0 TFSI	BWJ;CCZB;CDLD	For hot climate zones	11/06-12/12	7SEU17C	R134a	DCP32045	
2.0 TFSI	CCZB;CDLD	For cold climates;For mild climate zones	11/06-12/12	6SEU14C	R134a	DCP02050	
<b>LEON (5F) (12-)</b>							
1.0 TSI	CHZD;DKRF		05/15-	6SES14C	R134a	DCP32060	
1.2 TSI 16V	CJZA;CJZB;CYVA;CYVB		12/12-	6SES14C	R134a	DCP32060	
1.4 TGI	CPWA		02/13-	6SES14C	R134a	DCP32060	
1.4 TSI	CHPA;CMBA;CPTA;CXSA;CZCA;CZDA;CZEA		09/12-	6SES14C	R134a	DCP32060	
1.6 TDI	CLHA;CLHB;CRKB;CXXA;CXXB;DBKA;DDYA;DDYB;DGTE		11/12-	6SES14C	R134a	DCP32060	
1.6 TDI 4Drive	CLHA;CXXB		04/14-	6SES14C	R134a	DCP32060	
1.8 TSI	CJSA		02/13-	6SES14C	R134a	DCP32060	
1.8 TSI 4Drive	CJSB		11/14-	6SES14C	R134a	DCP32060	
2.0 Cupra	CJXA;CJXE;CJXH;DNUC		10/13-	6SES14C	R134a	DCP32060	
2.0 Cupra	CJXC		11/16-	6SES14C	R134a;R1234yf	DCP32080	
2.0 Cupra 4Drive	CJXC; DNUC		11/16-	6SES14C	R134a;R1234yf	DCP32080	
2.0 Cupra R	CJXG		11/17-	6SES14C	R134a;R1234yf	DCP32080	
2.0 TDI	CKFC;CRBC;CRLB;CRMB;CRVA;CRVC;CUNA;CUPA;DFFA;DFGA;DJGA		09/12-	6SES14C	R134a	DCP32060	
2.0 TDI 4Drive	CRBC;CRLB;CRMB;CUNA;DCYA;DFGA;DJGA		04/14-	6SES14C	R134a	DCP32060	
<b>TOLEDO III (5P) (04-09)</b>							
1.4 16V	BXW		05/06-05/09	7SEU17C	R134a	DCP32045	1K0820859S
1.4 16V	BXW	Ch No: 5P-7-063 001>5P-8-023 328	05/06-05/09	6SEU14C	R134a	DCP02030	
1.6	BGU; BSE; BSF; CCSA	For cold climates;For mild climate zones	03/07-09/07	6SEU14C	R134a	DCP02030	
1.6	BGU; BSE; BSF; CCSA	For hot climate zones	10/04-05/09	7SEU17C	R134a	DCP32045	
1.8 TFSI	BYT; BZB; CDAA	For cold climates;For mild climate zones	09/07-12/07	6SEU14C	R134a	DCP02050	
1.8 TFSI	BYT; BZB; CDAA	For hot climate zones	01/07-05/09	7SEU17C	R134a	DCP32045	
1.9 TDI	BJB; BKC; BLS; BXE		06/07-05/09	7SEU17C	R134a	DCP32045	
2.0 FSI	BLR; BLY; BVY; BVZ		06/07-05/09	7SEU17C	R134a	DCP32045	
2.0 TDI	AZV;BKD;BMN		06/07-05/09	7SEU17C	R134a	DCP32045	
2.0 TDI 8V	BMM		06/07-05/09	7SEU17C	R134a	DCP32045	
2.0 TFSI	BWA		06/07-05/09	7SEU17C	R134a	DCP32045	
<b>TOLEDO IV (KG3) (12-)</b>							
1.2 TSI	CBZA;CBZB		07/12-06/15	6SES14C	R134a	DCP32060	
1.2 TSI 16V	CJZC;CJZD		05/15-05/17	6SES14C	R134a	DCP32060	
1.4 TDI	CUSB		05/15-04/19	6SES14C	R134a	DCP32060	
1.4 TSI	CAXA		07/12-06/15	6SES14C	R134a	DCP32060	
1.4 TSI	CZCA		05/15-04/19	6SES14C	R134a	DCP32060	
1.6 TDI	CAYB;CAYC;CLNA;CXMA		07/12-04/19	6SES14C	R134a	DCP32060	
<b>SKODA</b>							
<b>FABIA I (6Y) (99-08)</b>							
1.0	AQV; ARV		10/00-08/02	6SEU14C	R134a	DCP32020	6Q0820803J
1.2	AWY;AZQ;BMD;BME		07/01-12/07	6SEU12C	R134a	DCP27002	6Q0820803G
1.2	AWY;AZQ;BMD;BME		07/01-12/07	6SEU14C	R134a	DCP32005	6Q0820803K
1.2	AWY;AZQ;BMD;BME		07/01-12/07	6SEU14C	R134a	DCP32020	6Q0820803J
1.4	AME;AQW;ATZ;AZE;AZF		08/99-05/03	6SEU14C	R134a	DCP32020	
1.4 16V	AUA;AUB;BBY;BBZ;BKY;BUD		10/99-12/07	6SEU14C	R134a	DCP32020	
1.4 TDI	AMF		04/03-07/04	6SEU12C	R134a	DCP27002	6Q0820803G
1.4 TDI	AMF		04/03-07/04	6SEU14C	R134a	DCP32005	6Q0820803K
1.4 TDI	AMF;BNM;BNV		04/03-12/07	6SEU14C	R134a	DCP32020	6Q0820803J
1.9 SDI	ASY		11/99-12/07	6SEU14C	R134a	DCP32020	











				TYPE	GAS	DENSO PN	OE
<b>SKODA</b> <i>Continued</i>							
<b>FABIA I (6Y) (99-08)</b> <i>Continued</i>							
1.9 TDI	ATD;AXR		01/00-12/07	6SEU14C	R134a	DCP32020	6Q0820803J
1.9 TDI RS	ASZ		06/03-07/04	6SEU14C	R134a	DCP32020	6Q0820803J
2.0	AZL		12/99-12/07	6SEU14C	R134a	DCP32020	
<b>FABIA II (06-14)</b>							
1.2	BBM;CHFA		12/06-12/14	6SEU14C	R134a	DCP32005	
1.2	BZG		01/07-12/14	6SEU14C	R134a	DCP32020	6Q0820803J
1.2 12V	CGPB		11/11-12/14	6SEU14C	R134a	DCP32005	
1.2 TDI	CFWA		05/10-12/14	6SEU14C	R134a	DCP02030	
1.2 TSI	CBZA;CBZB		03/10-12/14	6SEU14C	R134a	DCP02030	
1.4	BXW		01/07-12/14	6SEU14C	R134a	DCP32020	6Q0820803J
1.4 TDI	BMS;BNM;BNV		01/07-03/10	6SEU14C	R134a	DCP32020	
1.4 TSI RS	CAVE;CTHE		05/10-05/12	6SEU14C	R134a	DCP32020	
1.6	BTS		04/07-12/14	6SEU14C	R134a	DCP32020	6Q0820803J
1.6 TDI	CAYA;CAYB;CAYC		03/10-12/14	6SEU14C	R134a	DCP02030	
1.9 TDI	BLS;BSW		04/07-03/10	6SEU14C	R134a	DCP32020	
<b>FABIA III (NJ) (14-)</b>							
1.0	CHYA;CHYB		08/14-	6SES14C	R134a	DCP32060	
1.2 TSI 16V	CJZC;CJZD		08/14-	6SES14C	R134a	DCP32060	
1.4 TDI	CUSA;CUSB;CUTA		08/14-	6SES14C	R134a	DCP32060	
1.6	CWWA		01/15-	6SES14C	R134a	DCP32060	
<b>KAROQ (NU7) (17-)</b>							
1.0 TSI	CHZJ		07/17-	6SES14C	R134a; R1234yf	DCP32080	
1.5 TSI	DADA; DPCA		07/17-	6SES14C	R134a; R1234yf	DCP32080	
1.6 TDI	DDYA; DGTE		07/17-	6SES14C	R134a; R1234yf	DCP32080	
2.0 TDI 4x4	DFFA;DFHA		07/17-	6SES14C	R134a; R1234yf	DCP32080	
<b>KODIAQ (NS7) (17-)</b>							
1.4 TSI	CZCA;CZDA;CZEA		10/16-	6SES14C	R134a; R1234yf	DCP32080	
1.4 TSI 4x4	CZDA; CZEA		10/16-	6SES14C	R134a; R1234yf	DCP32080	
2.0 TDI	DBGA; DBGC; DFGA		10/16-	6SES14C	R134a; R1234yf	DCP32080	
2.0 TDI 4x4	DBGC;DFGA;DFHA		10/16-	6SES14C	R134a; R1234yf	DCP32080	
2.0 TSI 4x4	CZPA		10/16-	6SES14C	R134a; R1234yf	DCP32080	
<b>OCTAVIA I (1U) (96-10)</b>							
1.9 TDI	ASZ		09/02-09/04	7SEU16C	R134a	DCP32003	
1.9 TDI	ASZ	All Climate zones	09/02-09/04	7SEU17C	R134a	DCP32002	
<b>OCTAVIA II (1Z) (04-13)</b>							
1.2 TSI	CBZB	For cold climates;For mild climate zones	02/10-04/13	6SEU14C	R134a	DCP02050	
1.2 TSI	CBZB	For hot climate zones	02/10-04/13	7SEU17C	R134a	DCP32045	
1.4	BCA		05/04-05/06	7SEU17C	R134a	DCP32045	
1.4	BUD; CGGA	For cold climates	06/04-11/10	6SEU14C	R134a	DCP02030	
1.4	BUD; CGGA	For cold climates;For mild climate zones	05/06-11/10	6SEU14C	R134a	DCP02030	
1.4	BUD; CGGA	For hot climate zones	05/06-11/10	7SEU17C	R134a	DCP32045	
1.4	BUD; CGGA	For mild climate zones; For hot climates	06/04-11/10	7SEU17C	R134a	DCP32045	
1.4 TSI	CAXA	For cold climates;For mild climate zones	11/08-06/13	6SEU14C	R134a	DCP02030	
1.4 TSI	CAXA	For hot climate zones	11/08-06/13	7SEU17C	R134a	DCP32045	
1.6	BGU	For hot climate zones	06/04-05/05	7SEU17C	R134a	DCP32045	
1.6	BGU;BSE;BSF;CCSA;CMXA	For cold climates	05/05-10/08	6SEU14C	R134a	DCP02030	
1.6 FSI	BLF		02/04-10/08	7SEU17C	R134a	DCP32045	
1.6 LPG	CHGA	For cold climates	08/09-11/12	6SEU14C	R134a	DCP02030	





				TYPE	GAS	DENSO PN	OE
<b>SKODA</b> <i>Continued</i>							
<b>OCTAVIA II (1Z) (04-13)</b> <i>Continued</i>							
1.6 LPG	CHGA	For mild climate zones; For hot climates	08/09-11/12	7SEU17C	R134a	DCP32045	
1.6 TDI	CAYC	For cold climates	06/09-04/13	6SEU14C	R134a	DCP02050	
1.6 TDI	CAYC	For mild climate zones; For hot climates	06/09-04/13	7SEU17C	R134a	DCP32045	
1.6 TDI 4x4	CAYC	For cold climates	06/09-02/13	6SEU14C	R134a	DCP02050	
1.6 TDI 4x4	CAYC	For mild climate zones; For hot climates	06/09-02/13	7SEU17C	R134a	DCP32045	
1.8	CDA A	For cold climates	11/08-04/13	6SEU14C	R134a	DCP02030	
1.8	CDA A	For mild climate zones; For hot climates	11/08-04/13	7SEU17C	R134a	DCP32045	
1.8 TSI	CDA A	For cold climates	11/08-04/13	6SEU14C	R134a	DCP02030	
1.8 TSI	CDA A;CDAB	For mild climate zones; For hot climates	11/08-06/13	7SEU17C	R134a	DCP32045	
1.8 TSI	CDAB	For cold climates	03/09-06/13	6SEU14C	R134a	DCP02050	
1.8 TSI 4x4	CDA A	For cold climates;For mild climate zones	11/08-02/13	6SEU14C	R134a	DCP02030	
1.8 TSI 4x4	CDA A	For hot climate zones	11/08-02/13	7SEU17C	R134a	DCP32045	
1.8 TSI 4x4	CDAB	For cold climates	03/09-02/13	6SEU14C	R134a	DCP02050	
1.8 TSI 4x4	CDAB	For mild climate zones; For hot climates	03/09-02/13	7SEU17C	R134a	DCP32045	
1.9 TDI	BJB; BKC; BLS; BXE		06/04-12/10	7SEU17C	R134a	DCP32045	
1.9 TDI	BJB; BKC; BLS; BXE		09/04-12/10	7SEU16C	R134a	DCP32003	
1.9 TDI	BJB; BKC; BLS; BXE	All Climate zones	09/04-12/10	7SEU17C	R134a	DCP32002	
1.9 TDI 4x4	BKC; BLS; BXE		11/04-12/10	7SEU16C	R134a	DCP32003	
1.9 TDI 4x4	BKC; BLS; BXE	All Climate zones	11/04-12/10	7SEU17C	R134a	DCP32002	
2.0 FSI	BLR;BLY;BVY;BVZ		11/04-10/08	7SEU17C	R134a	DCP32045	
2.0 FSI 4x4	BLX; BVX		11/04-10/08	7SEU17C	R134a	DCP32045	
2.0 RS	BWA;CCZA		10/05-02/13	7SEU17C	R134a	DCP32045	
2.0 TDI	AZV;BKD;CFHC;CLCB		02/04-04/13	7SEU17C	R134a	DCP32045	
2.0 TDI	BKD;CFHC;CFHF;CLCA;CLCB	For cold climates;For mild climate zones	02/04-06/13	6SEU14C	R134a	DCP02050	
2.0 TDI	BKD;CFHC;CFHF;CLCA;CLCB	For hot climate zones	02/04-06/13	7SEU17C	R134a	DCP32045	
2.0 TDI 4x4	CFHC;CFHF	For cold climates;For mild climate zones	05/10-02/13	6SEU14C	R134a	DCP02050	
2.0 TDI 4x4	CFHC;CFHF	For hot climate zones	05/10-02/13	7SEU17C	R134a	DCP32045	
2.0 TDI 8V	BMM		11/05-05/10	7SEU17C	R134a	DCP32045	
2.0 TDI 8V 4x4	BMM		07/06-05/10	7SEU17C	R134a	DCP32045	
2.0 TDI RS	BMN	For cold climates	04/06-10/08	6SEU14C	R134a	DCP02030	
<b>OCTAVIA III (5E) (12-)</b>							
1.0 TSI	CHZD;DKRA		05/16-	6SES14C	R134a; R1234yf	DCP32080	
1.2 TSI 16V	CJZA;CJZB;CYVA;CYVB		11/12-	6SES14C	R134a	DCP32060	
1.4 TSI	CHPA;CHPB;CZDA		11/12-	6SES14C	R134a	DCP32060	
1.4 TSI G-TEC	CPWA		11/13-	6SES14C	R134a	DCP32060	
1.5 TSI	DADA;DPCA		02/17-	6SES14C	R134a; R1234yf	DCP32080	
1.6	CWVA		01/14-	6SES14C	R134a	DCP32060	
1.6 TDI	CLHA;CLHB;CRKB;CXXA;CXXB;DBKA;DDY B		11/12-	6SES14C	R134a	DCP32060	





				TYPE	GAS	DENSO PN	OE
<b>SKODA</b> <i>Continued</i>							
<b>OCTAVIA III (5E) (12-)</b> <i>Continued</i>							
1.6 TDI	DDYA;DGTE		02/17-	6SES14C	R134a; R1234yf	DCP32080	
1.6 TDI 4x4	CLHA;CXXB		11/12-	6SES14C	R134a	DCP32060	
1.8 TSI	CJSA		11/12-	6SES14C	R134a	DCP32060	
1.8 TSI 4x4	CJSB		11/12-	6SES14C	R134a	DCP32060	
2.0 TDI	CKFB;CKFC;CRMB;CRVC;CYKA;DCYA;DFF A		11/12-	6SES14C	R134a	DCP32060	
2.0 TDI / TDI RS 4x4	CUNA;CUPA;DJGA		09/14-	6SES14C	R134a	DCP32060	
2.0 TDI 4x4	CKFC;CRMB;DCYA;DFFA		11/12-	6SES14C	R134a	DCP32060	
2.0 TDI RS	CUNA;CUPA;DJGA		05/13-	6SES14C	R134a	DCP32060	
2.0 TSI RS	CHHA;CHHB		11/12-	6SES14C	R134a	DCP32060	
2.0 TSI RS	DHGA;DKTB;DLBA		02/17-	6SES14C	R134a; R1234yf	DCP32080	
<b>RAPID (HN) (12-)</b>							
1.0 TSI	CHZB;CHZC;DKLD;DKRC		06/17-	6SES14C	R134a	DCP32060	
1.2	CGPC		07/12-	6SES14C	R134a	DCP32060	
1.2 TSI	CBZA;CBZB		07/12-	6SES14C	R134a	DCP32060	
1.2 TSI 16V	CJZC;CJZD		05/15-	6SES14C	R134a	DCP32060	
1.4 TDI	CUSB		05/15-	6SES14C	R134a	DCP32060	
1.4 TSI	CAXA		07/12-	6SES14C	R134a	DCP32060	
1.4 TSI	CZCA		05/15-	6SES14C	R134a	DCP32060	
1.6	CWVA		05/15-	6SES14C	R134a	DCP32060	
1.6 TDI	CAYB;CAYC;CLNA;CXMA		07/12-	6SES14C	R134a	DCP32060	
<b>ROOMSTER (5J) (06-15)</b>							
1.2	BME;BZG;CGPA		05/06-03/09	6SEU14C	R134a	DCP32005	
1.2 TDI	CFWA		03/10-05/15	6SEU14C	R134a	DCP02050	
1.2 TSI	CBZA;CBZB		03/10-05/15	6SEU14C	R134a	DCP02050	
1.4	BXW		09/06-03/10	6SEU14C	R134a	DCP32020	6Q0820803J
1.4 TDI	BMS		09/06-03/10	6SEU14C	R134a	DCP32005	
1.4 TDI	BNM;BNV		07/06-03/10	6SEU14C	R134a	DCP32020	
1.6	BTS		09/06-03/10	6SEU14C	R134a	DCP32020	6Q0820803J
1.6 TDI	CAYB;CAYC		03/10-05/15	6SEU14C	R134a	DCP02050	
1.9 TDI	AXR;BLS;BSW		03/06-03/10	6SEU14C	R134a	DCP32020	
<b>SUPERB I (3U) (01-08)</b>							
1.8 T	AWT		12/01-03/08	7SBU16C	R134a	DCP02006	
1.9 TDI	AVB;AVF;AWX;BPZ;BSV		12/01-03/08	7SBU16C	R134a	DCP02006	
2.0	AZM		12/01-03/08	7SBU16C	R134a	DCP02006	
2.0 TDI 8V	BSS		10/05-03/08	7SBU16C	R134a	DCP02006	
2.5 TDI	AYM;BDG		12/01-03/08	7SBU16C	R134a	DCP02004	
2.8 V6	AMX		12/01-03/08	7SBU16C	R134a	DCP02005	4B0260805B
2.8 V6	BBG		12/01-03/08	7SBU16C	R134a	DCP02004	4B0260805C
<b>SUPERB II (3T) (08-15)</b>							
1.4 TSI	CAXC		07/08-05/15	7SEU17C	R134a	DCP32045	
1.6 TDI	CAYC	For cold climates	09/10-05/15	6SEU14C	R134a	DCP02050	
1.6 TDI	CAYC	For mild climate zones; For hot climates	09/10-05/15	7SEU17C	R134a	DCP32045	
1.8 TSI	BZB;CDAA;CDAB		03/08-05/13	7SEU17C	R134a	DCP32045	
1.8 TSI	CDAA;CDAB		05/13-05/15	6SES14C	R134a	DCP32060	
1.8 TSI 4x4	CDAA;CDAB		11/08-05/13	7SEU17C	R134a	DCP32045	
1.8 TSI 4x4	CDAA;CDAB		05/13-05/15	6SES14C	R134a	DCP32060	
1.9 TDI	BLS;BXE		03/08-11/10	7SEU17C	R134a	DCP32045	
2.0 TDI	BKD;CBBB		07/08-05/10	7SEU17C	R134a	DCP32045	
2.0 TDI 4x4	CBBB;CFFB		09/08-05/15	7SEU17C	R134a	DCP32045	
2.0 TDI 8V	BMP		03/08-03/10	7SEU17C	R134a	DCP32045	
2.0 TSI	CCZA		05/10-05/15	7SEU17C	R134a	DCP32045	
3.6 FSI 4x4	CDVA		11/08-05/15	7SEU17C	R134a	DCP32045	
3.6 V6 4x4	CDVA		10/09-05/15	7SEU17C	R134a	DCP32045	
<b>SUPERB III (3V) (15-)</b>							
1.4 TSI	CZCA;CZDA;CZEA		03/15-12/16	6SES14C	R134a	DCP32060	
1.4 TSI 4x4	CZEA		03/15-12/16	6SES14C	R134a	DCP32060	
1.6 TDI	DCXA;DCZA		03/15-12/16	6SES14C	R134a	DCP32060	
1.8 TSI	CJSA;CJSC		03/15-12/16	6SES14C	R134a	DCP32060	
2.0 TDI	CRLB;DDAA;DFCA;DFEA;DFGA;DFHA;DSR A; DSRB		03/15-12/16	6SES14C	R134a	DCP32060	
2.0 TDI 4x4	CRLB;DDAA;DFCA;DFEA;DFGA;DFHA		03/15-12/16	6SES14C	R134a	DCP32060	
2.0 TSI	CHHB		03/15-12/16	6SES14C	R134a	DCP32060	

				TYPE	GAS	DENSO PN	OE
<b>SKODA</b> <i>Continued</i>							
<b>SUPERB III (3V) (15-) Continued</b>							
2.0 TSI 4x4	CJXA		03/15-12/16	6SES14C	R134a	DCP32060	
<b>YETI (5L) (09-)</b>							
1.2 TSI	CBZB	For cold climates; For mild climate zones	09/09-05/15	6SEU14C	R134a	DCP02050	
1.2 TSI	CBZB	For hot climate zones	09/09-05/15	7SEU17C	R134a	DCP32045	
1.2 TSI 16V	CYVB	For cold climates; For mild climate zones	05/15-12/17	6SEU14C	R134a	DCP02050	
1.2 TSI 16V	CYVB	For hot climate zones	05/15-12/17	7SEU17C	R134a	DCP32045	
1.4 TSI	CAXA	For cold climates; For mild climate zones	06/10-05/15	6SEU14C	R134a	DCP02030	
1.4 TSI	CAXA	For hot climate zones	06/10-05/15	7SEU17C	R134a	DCP32045	
1.4 TSI	CZCA	For cold climates; For mild climate zones	05/15-12/17	6SEU14C	R134a	DCP02050	
1.4 TSI	CZCA	For hot climate zones	05/15-12/17	7SEU17C	R134a	DCP32045	
1.4 TSI 4x4	CZDA	For cold climates; For mild climate zones	05/15-12/17	6SEU14C	R134a	DCP02050	
1.4 TSI 4x4	CZDA	For hot climate zones	05/15-12/17	7SEU17C	R134a	DCP32045	
1.6	CWVA		04/14-12/17	7SEU17C	R134a	DCP32045	
1.6 TDI	CAYC	For cold climates	11/10-05/15	6SEU14C	R134a	DCP02050	
1.6 TDI	CAYC	For mild climate zones; For hot climates	11/10-05/15	7SEU17C	R134a	DCP32045	
1.8 TSI 4x4	CDA; CDAB	For cold climates; For mild climate zones	05/09-12/17	6SEU14C	R134a	DCP02050	
1.8 TSI 4x4	CDA; CDAB	For hot climate zones	05/09-12/17	7SEU17C	R134a	DCP32045	
2.0 TDI	CFHA; CFHC; CLCA; CUUA; DFSA	For cold climates	11/09-12/17	6SEU14C	R134a	DCP02050	
2.0 TDI	CFHA; CFHC; CLCA; CUUA; DFSA	For mild climate zones; For hot climates	11/09-12/17	7SEU17C	R134a	DCP32045	
2.0 TDI	CUUB; DFSB	For cold climates; For mild climate zones	05/15-12/17	6SEU14C	R134a	DCP02050	
2.0 TDI	CUUB; DFSB	For hot climate zones	05/15-12/17	7SEU17C	R134a	DCP32045	
2.0 TDI 4x4	CBDB; CEGA; CFHC; CFHF; CFJA; CLCB; CUUA; DFSA	For cold climates	05/09-12/17	6SEU14C	R134a	DCP02050	
2.0 TDI 4x4	CBDB; CEGA; CFHC; CFHF; CFJA; CLCB; CUUA; DFSA	For mild climate zones; For hot climates	05/09-12/17	7SEU17C	R134a	DCP32045	
2.0 TDI 4x4	CUUB; DFSB	For cold climates; For mild climate zones	05/15-12/17	6SEU14C	R134a	DCP02050	
2.0 TDI 4x4	CUUB; DFSB	For hot climate zones	05/15-12/17	7SEU17C	R134a	DCP32045	
<b>SMART</b>							
<b>FORFOUR I (454) (04-06)</b>							
1.1	M 134.910; M 134.911		04/04-06/06	5SE09C	R134a	DCP17054	A4542300111
1.3	M 135.930		04/04-06/06	5SE09C	R134a	DCP17054	A4542300111
1.5	M 135.950		04/04-06/06	5SE09C	R134a	DCP17054	A4542300111
1.5 BRABUS	M 122.950		05/05-06/06	5SE09C	R134a	DCP17056	A1222300011
1.5 CDI	OM 639.939		09/04-06/06	5SE09C	R134a	DCP17054	
<b>ROADSTER (452) (03-05)</b>							
0.7	M 160.921; M 160.922		04/03-11/05	5SE09C	R134a	DCP17054	A4542300111
0.7 Brabus	M 160.923		12/03-11/05	5SE09C	R134a	DCP17054	A4542300111
<b>SUBARU</b>							
<b>BRZ (12-)</b>							
2.0	FA20D		06/12-	SCSA08H	R134a; R1234yf	DCP50315	





				TYPE	GAS	DENSO PN	OE
<b>SUBARU</b> <i>Continued</i>							
<b>LEGACY III (98-03)</b>							
2.0 AWD	EJ201		12/98-04/03	TV12C	R134a	DCP36006	73111-AE080
2.5 AWD	EJ25		10/98-08/03	TV12C	R134a	DCP36006	73111-AE080
<b>LEGACY IV (03-09)</b>							
2.0 AWD	EJ20X;EJ204		06/05-04/09	SCSA08C	R134a	DCP36001	73111-AG030
2.0 AWD	EJ202		09/03-10/05	SCSA08C	R134a	DCP36002	
2.0 R AWD	EJ204		09/07-12/09	SCSA08C	R134a	DCP36001	73111-AG030
2.5 AWD	EJ25		09/03-06/06	SCSA08C	R134a	DCP36002	73111-AG00*
2.5 AWD	EJ25		04/06-04/09	SCSA08C	R134a	DCP36001	73111-AG030
2.5 i AWD	EJ25		09/07-12/09	SCSA08C	R134a	DCP36001	73111-AG030
3.0 R AWD	EZ30		09/03-05/09	SCSA08C	R134a	DCP36003	73111-AG01*
<b>LEGACY V (09-14)</b>							
2.0 D AWD	EE20;EE20Z		09/09-12/14	10S15L	R134a	DCP36004	
2.0 i AWD	EJ204		09/09-12/14	SCSA08C	R134a	DCP36001	
2.0 i LPG AWD	EJ204		09/09-12/11	SCSA08C	R134a	DCP36001	
2.5 GT AWD	EJ255		07/10-12/14	SCSA08C	R134a	DCP36001	
2.5 i AWD	EJ253		09/09-12/14	SCSA08C	R134a	DCP36001	
<b>OUTBACK (00-03)</b>							
2.5 AWD	EJ25		10/00-08/03	TV12C	R134a	DCP36006	73111-AE080
3.0 H6 AWD	EZ30		10/00-08/03	TV14C	R134a	DCP36005	73111-AE030
3.0 H6 AWD	EZ30		10/00-08/03	TV12C	R134a	DCP36006	73111-AE080
<b>OUTBACK (03-09)</b>							
2.5 AWD	EJ25D		11/03-06/06	SCSA08C	R134a	DCP36002	73111-AG00*
2.5 AWD	EJ25D;EJ251		04/06-09/09	SCSA08C	R134a	DCP36001	73111-AG030
3.0 AWD	EZ30		11/03-09/09	SCSA08C	R134a	DCP36003	73111-AG01*
<b>OUTBACK (09-)</b>							
2.0 D AWD	EE20Z		09/09-	10S15L	R134a	DCP36004	
2.5 i AWD	EJ253		09/09-	SCSA08C	R134a	DCP36001	
2.5 i AWD	FB25B		01/13-	SCSA08C	R134a	DCP36001	
3.6 AWD	EZ36D		06/11-12/14	SCSA08C	R134a	DCP36002	
3.6 R AWD	EZ36D		09/09-	SCSA08C	R134a	DCP36002	
<b>OUTBACK (15-)</b>							
2.0 D AWD	EE20Z		03/15-	SCSA08H	R134a; R1234yf	DCP50315	
2.5 AWD	FB25		03/15-	SCSA08H	R134a; R1234yf	DCP50315	
<b>TRIBECA (05-)</b>							
3.0	EZ30		10/06-09/07	10SR17C	R134a	DCP36007	
3.6	EZ36D		09/07-10/09	10SR17C	R134a	DCP36007	
<b>SUZUKI</b>							
<b>ALTO III (93-02)</b>							
1.0	G10BB		09/94-06/02	10P08E	R134a	DCP47008	
<b>ALTO IV (02-08)</b>							
1.1	F10D		09/04-03/06	10S11C	R134a	DCP47006	
<b>BALENO (95-02)</b>							
1.3	G13BA		09/96-05/02	SS10	R134a	DCP47007	
1.3 16V	G13BB		03/97-05/02	SS10	R134a	DCP47007	
1.3 i 16V	G13BB		07/95-05/02	SS10	R134a	DCP47007	
1.6 i 16V	G16B		07/95-05/02	SS10	R134a	DCP47007	
1.6 i 16V 4x4	G16B		07/95-05/02	SS10	R134a	DCP47007	
<b>Grand VITARA I (98-06)</b>							
2.0 4x4	J20A		01/01-07/03	10S11C	R134a	DCP47001	95200-67D01
2.0 HDI 110 16V 4x4	RHW		07/01-09/05	10S13C	R134a	DCP47004	95200-65DJ0
2.7 4x4	H 27 A	For vehicles with front and rear air conditioning	09/01-07/03	10S13C	R134a	DCP47003	
<b>LIANA (01-07)</b>							
1.3	M13A		07/01-12/07	10S13C	R134a	DCP47003	
1.6	M16A		07/01-12/07	10S13C	R134a	DCP47003	
1.6 4WD	M16A		04/02-12/07	10S13C	R134a	DCP47003	
1.6 i	M16A		04/02-04/04	10S13C	R134a	DCP47003	
<b>SWIFT III (05-)</b>							
1.6	M16A		05/06-09/11	10S13C	R134a	DCP47003	95200-65DA0
<b>SX4 (06-)</b>							
1.5	M15A		06/06-06/09	5SL12C	R134a	DCP09017	95200-79JA0
1.6	M16A		10/07-06/09	5SL12C	R134a	DCP09017	95200-79JA0
1.6 DDIS	9HX		07/07-06/09	5SL12C	R134a	DCP09017	95200-79JA0
1.6 VVT	M16A		06/06-06/09	5SL12C	R134a	DCP09017	95200-79JA0





				TYPE	GAS	DENSO PN	OE
<b>SUZUKI</b> <i>Continued</i>							
<b>SX4 (06-)</b> <i>Continued</i>							
1.6 VVT 4x4	M16A			06/06-06/09	5SL12C	R134a	DCP09017 95200-79JA0
1.9 DDiS	D19AA			06/06-06/09	5SL12C	R134a	DCP09017 95200-79JA0
1.9 DDiS 4x4	D19AA			06/06-06/09	5SL12C	R134a	DCP09017 95200-79JA0
2.0 DDiS	D20AA			07/09-	5SL12C	R134a	DCP09017 95200-79JA0
2.0 DDiS 4x4	D20AA			07/09-	5SL12C	R134a	DCP09017 95200-79JA0
<b>SX4 S-Cross (13-)</b>							
1.0	K10C			08/16-	10SRE13C	R134a; R1234yf	DCP47012
1.0 AWD	K10C			08/16-	10SRE13C	R134a; R1234yf	DCP47012
1.4 T	K14C			08/16-	10SRE13C	R134a; R1234yf	DCP47013
1.4 T AWD	K14C			08/16-	10SRE13C	R134a; R1234yf	DCP47013
1.6	M16A			08/13-	10SRE13C	R134a; R1234yf	DCP47011
1.6 AWD	M16A			08/13-	10SRE13C	R134a; R1234yf	DCP47011
1.6 DDiS	D16AA			08/13-	5SL12C	R134a; R1234yf	DCP47009
1.6 DDiS	D16AA			08/13-	5SL12C	R134a; R1234yf	DCP47010
1.6 DDiS AWD	D16AA			08/13-	5SL12C	R134a; R1234yf	DCP47009
1.6 DDiS AWD	D16AA			08/13-	5SL12C	R134a; R1234yf	DCP47010
<b>VITARA (15-)</b>							
1.0	K10C			10/18-	10SRE13C	R134a; R1234yf	DCP47012
1.0 AWD	K10C			10/18-	10SRE13C	R134a; R1234yf	DCP47012
1.4 T	K14C			09/15-	10SRE13C	R134a; R1234yf	DCP47013
1.4 T AWD	K14C			09/15-	10SRE13C	R134a; R1234yf	DCP47013
1.6	M16A			02/15-	10SRE13C	R134a; R1234yf	DCP47011
1.6 AWD	M16A			02/15-	10SRE13C	R134a; R1234yf	DCP47011
1.6 DDiS	D16AA			02/15-	5SL12C	R134a; R1234yf	DCP47010
1.6 DDiS AWD	D16AA			02/15-	5SL12C	R134a; R1234yf	DCP47010
1.6 VVT AllGrip	M16A			08/16-	10SRE13C	R134a; R1234yf	DCP47011
<b>TOYOTA</b>							
<b>4 RUNNER (N10) (89-96)</b>							
3.0	3VZ-E			01/90-10/95	10PA15C	R134a	DCP50021
3.0 Turbo-D	1KZ-T			10/93-03/96	10PA15C	R134a	DCP50021
<b>4 RUNNER (N18) (95-02)</b>							
3.0 Turbo-D	1KZ-T			11/95-06/98	10PA17C	R134a	DCP50078
<b>ALLION II (07-)</b>							
1.8	2ZR-FAE			07/07-02/13	6SEU14C	R134a	DCP50228
1.8 4WD	2ZR-FAE			07/07-02/13	6SEU14C	R134a	DCP50228
<b>ALTEZZA (99-05)</b>							
2.0 VVTi	1G-FE			01/99-05/05	10S15C	R134a	DCP51000 88320-53020; 88410-53010
<b>AURIS (E15) (06-12)</b>							
1.33 Dual-VVTi	1NR-FE			05/09-09/12	5SER09C	R134a	DCP50304 88310-1A800; 88310-0D320
1.4	4ZZ-FE			03/07-12/08	5SE12C	R134a	DCP50306 88310-02540
1.4 D-4D	1ND-TV			03/07-01/10	5SER09C	R134a	DCP50300 88310-02390
1.4 D-4D	1ND-TV			12/08-09/12	5SER09C	R134a	DCP50305 88310-1A820
1.4 D-4D	1ND-TV			02/09-09/12	5SER09C	R134a	DCP50304 88310-0D320
1.5	1NZ-FE			09/09-09/12	5SER09C	R134a	DCP50249
1.5 4WD	1NZ-FE			09/09-09/12	5SER09C	R134a	DCP50249
1.6	1ZR-FAE;1ZR-FE			03/07-09/12	6SEU14C	R134a	DCP50302
1.8	2ZR-FAE			02/09-09/12	6SEU14C	R134a	DCP50302
1.8	2ZR-FAE; 2ZR-FE			10/06-09/12	6SEU14C	R134a	DCP50228
1.8 4WD	2ZR-FAE			02/09-09/12	6SEU14C	R134a	DCP50302
1.8 Hybrid	2ZR-FXE			09/10-09/12	ES14	R134a	DCP50502
2.0 D-4D	1AD-FTV			10/06-10/09	5SE12C	R134a	DCP50301
2.2 D	2AD-FHV			11/06-09/12	5SE12C	R134a	DCP50301





				TYPE	GAS	DENSO PN	OE
<b>TOYOTA</b> <i>Continued</i>							
<b>AURIS (E18) (12-)</b>							
1.2	8NR-FTS		03/15-12/18	6SES12C	R134a; R1234yf	DCP50316	
1.3	1NR-FE		10/12-12/18	5TSE10C	R134a	DCP50308	88310-02830
1.3	1NR-FE		10/12-12/18	5TSE10C	R134a	DCP50319	
1.4 D-4D	1ND-TV		10/12-12/18	5TSE10C	R134a	DCP50309	
1.6	1ZR-FAE		10/12-05/15	6SES14C	R134a	DCP50312	
1.6	1ZR-FAE		10/12-12/18	6SES14C	R134a	DCP50310	
1.6 D4-D	1WW		04/15-12/18	5SE12C	R134a	DCP50314	
1.8 Hybrid	2ZR-FXE		10/12-12/18	ES14	R134a	DCP50502	
2.0 D-4D	1AD-FTV		10/12-05/15	5SE12C	R134a	DCP50301	
<b>AVENSIS (97-03)</b>							
1.6	4A-FE		09/97-06/00	10PA15C	R134a	DCP50021	88310-2B590
1.6	3ZZ-FE		07/00-02/03	10S15L	R134a	DCP50020	88310-05040
1.8	7AFE;7A-FE		09/97-06/00	10PA15C	R134a	DCP50021	88310-2B590
1.8	1ZZ-FE		10/00-02/03	10S15L	R134a	DCP50020	88310-05040
2.0	1AZ-FSE		10/00-02/03	10S15C	R134a	DCP50022	88310-05050
2.0	3S-FE		09/97-10/00	10PA15L	R134a	DCP50023	88310-2B550
2.0 D	2C-T		10/97-05/98	10PA15L	R134a	DCP50024	
2.0 D	1CD-FTV		09/02-02/03	10S15L	R134a	DCP50026	88320-2B410
2.0 D-4D	1CD-FTV		10/99-02/03	10S15L	R134a	DCP50026	64526935613
2.0 TD	2C-TE		09/97-06/00	10PA15L	R134a	DCP50024	88310-2B560
2.0 VVT-i	1AZ-FSE		10/00-02/03	10S15C	R134a	DCP50022	88310-05050
<b>AVENSIS (03-09)</b>							
1.6 VVT-i	3ZZ-FE		04/03-11/08	5SE12C	R134a	DCP50120	88310-05080
1.8	1ZZ-FE		03/03-11/08	5SE12C	R134a	DCP50120	88310-05080
2.0	1AZ-FSE		03/03-11/08	5SE12C	R134a	DCP50121	88310-05090
2.0 D-4D	1CD-FTV		04/03-04/06	5SE12C	R134a	DCP50122	88310-05100
2.0 D-4D	1CD-FTV		04/03-04/06	5SE12C	R134a	DCP50123	88310-05110
2.0 D-4D	1AD-FTV		03/06-11/08	5SE12C	R134a	DCP50124	88310-05120
2.0 VVTi	1AZ-FE		04/03-11/08	5SE12C	R134a	DCP50121	88310-05090
2.2 D-4D	2AD-FTV		10/05-11/08	5SE12C	R134a	DCP50124	88310-05120
2.2 D-CAT	2AD-FHV		07/05-11/08	5SE12C	R134a	DCP50124	88310-05120
2.4	2AZ-FSE		09/03-11/08	5SE12C	R134a	DCP50121	88310-05090
2.4	2AZ-FSE		04/06-10/08	5SE12C	R134a	DCP50124	88310-05120
<b>AVENSIS (08-)</b>							
1.6	1ZR-FAE		11/08-10/18	6SEU14C	R134a	DCP50302	
1.6 D4-D	1WW		04/15-10/18	5SE12C	R134a	DCP50314	
1.8	2ZR-FAE		11/08-10/18	6SEU14C	R134a	DCP50302	
1.8	2ZR-FAE		01/11-10/18	6SEU14C	R134a	DCP50228	88310-05140
2.0	3ZR-FAE;3ZR-FE		11/08-10/18	6SEU14C	R134a	DCP50228	88310-05140
2.0	3ZR-FAE;3ZR-FE		11/08-10/18	6SEU14C	R134a	DCP50302	
2.0 D-4D	2WW		04/15-10/18	6SEU14C	R134a	DCP50302	
2.0 D-4D	1AD-FTV		11/08-10/18	5SE12C	R134a	DCP50301	
2.2 D-4D	2AD-FHV;2AD-FTV		11/08-10/18	5SE12C	R134a	DCP50301	
<b>AVENSIS Verso (01-09)</b>							
2.0	1AZ-FE		10/03-07/05	10S17C	R134a	DCP50224	88310-44200
2.0	1AZ-FE	For vehicles with air conditioning front and rear	08/01-10/03	10S15C	R134a	DCP50220	88310-44150
2.0	1AZ-FE	For vehicles with sun roof	08/01-09/03	10S17C	R134a	DCP50221	88310-44160
2.0 D	1CD-FTV	For vehicles with sun roof	08/01-09/03	10S15L	R134a	DCP50222	88310-44170
2.0 D	1CD-FTV	For vehicles with sun roof	08/01-09/03	10S17C	R134a	DCP50223	88310-44180
2.0 D	1CD-FTV	For vehicles with sun roof	10/03-08/05	10S17C	R134a	DCP50083	88310-44220
2.0 D	1CD-FTV	For vehicles with sun roof	10/03-08/05	10S15L	R134a	DCP50225	88310-44210
<b>CAMRY (V3) (01-06)</b>							
2.0 VVTi	1AZ-FE		08/01-05/04	10S17C	R134a	DCP50040	88310-06130
2.0 VVTi	1AZ-FE		06/04-02/06	10S17C	R134a	DCP50041	88310-33220
2.4	2AZ-FE		11/01-05/04	10S17C	R134a	DCP50040	
2.4	2AZ-FE		06/04-02/06	10S17C	R134a	DCP50041	
<b>CAMRY (V4) (06-11)</b>							
2.4	2AZ-FE		01/06-09/11	6SEU16C	R134a	DCP50042	88310-33250
2.4 Hybrid	2AZ-FXE		01/06-07/11	Old ES27	R134a	DCP51005	
2.4 VVTi	2AZ-FE		01/06-01/09	6SEU16C	R134a	DCP50042	88310-33250
<b>CAMRY (V5) (11-)</b>							
2.5	2AR-FE		09/11-	TSE17C	R134a	DCP50101	





				TYPE	GAS	DENSO PN	OE
<b>TOYOTA</b> <i>Continued</i>							
<b>CARINA E (92-97)</b>							
1.6	4A-FE			10PA15C	R134a	DCP50050	88310-2B301
1.6	4A-FE	Great Britain	05/94-09/94	10PA15C	R134a	DCP50050	88310-2B301
1.6	4A-FE	Japan	12/93-09/97	10PA15C	R134a	DCP50050	88310-2B301
1.6 16V	4A-FE	Great Britain	10/95-09/97	10PA15C	R134a	DCP50050	88310-2B301
1.6 16V	4A-FE	Japan	12/94-09/97	10PA15C	R134a	DCP50050	88310-2B301
1.6 GLI	4A-FE	Great Britain	01/93-12/95	10PA15C	R134a	DCP50050	88310-2B301
1.8	7A-FE		01/95-09/97	10PA15C	R134a	DCP50050	
1.8 i	7A-FE		02/95-09/97	10PA15C	R134a	DCP50050	
1.8 i 16V	7AFE		01/95-09/97	10PA15C	R134a	DCP50050	88310-2B301
2.0 D	2C		08/92-01/96	10PA15L	R134a	DCP50024	
2.0 TD	2C-T		01/96-09/97	10PA15L	R134a	DCP50024	
<b>CELICA (93-99)</b>							
1.8 i 16V	7A-FE		11/93-11/99	10PA15C	R134a	DCP50021	
<b>CELICA (99-05)</b>							
1.8 16V TS	2ZZ-GE		08/99-08/02	10S15L	R134a	DCP50060	88310-2B680
1.8 16V VT-i	1ZZ-FE		08/99-08/02	10S15L	R134a	DCP50060	88310-2B680
<b>CELSIOR (00-06)</b>							
4.3 VTI	3UZ-FE		09/00-08/06	6SEU16C	R134a	DCP51003	
<b>COROLLA (E11) (97-02)</b>							
1.4	4ZZ-FE	Great Britain, Japan	10/99-01/02	SCSA06C	R134a	DCP50011	
1.4 16V	4ZZ-FE		02/00-11/01	SCS06C	R134a	DCP50014	
1.6	3ZZ-FE		10/99-01/02	SCS06C	R134a	DCP50014	
1.6 16V	3ZZ-FE		10/99-10/01	SCS06C	R134a	DCP50014	
1.9 D	1WZ		02/00-01/02	SCS06C	R134a	DCP50014	
<b>COROLLA (E12) (01-07)</b>							
1.4 D	1ND-TV		07/04-02/07	SCSA06C	R134a	DCP50010	88320-52420; 88410-1A330
1.4 D-4D	1ND-TV		06/04-10/06	SCSA06C	R134a	DCP50010	88320-52420; 88410-1A330
1.4 D4-D	1ND-TV		06/04-10/07	SCSA06C	R134a	DCP50010	88320-52420; 88410-1A330
1.4 VVT-i	4ZZ-FE		10/01-10/06	SCSA06C	R134a	DCP50013	88310-02192
1.4 VVT-i	4ZZ-FE		11/01-02/07	SCSA06C	R134a	DCP50011	88320-1A481
1.4 VVT-i	4ZZ-FE		11/01-02/07	SCSA06C	R134a	DCP50015	88320-1A550
1.4 VVT-i	4ZZ-FE	Great Britain	09/03-10/06	SCSA06C	R134a	DCP50011	88310-02182
1.4 VVT-i	4ZZ-FE	Japan	08/03-10/06	SCSA06C	R134a	DCP50013	88310-02192
1.6 VVT-i	3ZZ-FE		01/02-12/06	SCSA06C	R134a	DCP50011	88320-1A481
1.6 VVT-i	3ZZ-FE		01/02-12/06	SCSA06C	R134a	DCP50015	88320-1A550
1.6 VVT-i	3ZZ-FE	Great Britain	09/03-03/08	SCSA06C	R134a	DCP50011	88310-02182
1.6 VVT-i	3ZZ-FE	Japan	01/02-03/08	SCSA06C	R134a	DCP50013	88310-02192
1.8 VVTL-i TS	2ZZ-GE		01/02-02/07	SCSA06C	R134a	DCP50011	88320-1A481
2.0 D-4D	1CD-FTV		01/02-02/07	SCSA06C	R134a	DCP50011	88320-1A481
2.0 D-4D	1CD-FTV		09/02-02/07	SCSA06C	R134a	DCP50015	88320-1A550
<b>COROLLA (E14, E15) (06-)</b>							
1.33	1NR-FE		12/08-04/10	5SER09C	R134a	DCP50304	88310-1A800
1.4 D-4D	1ND-TV		10/06-07/14	5SER09C	R134a	DCP50305	
1.4 VVT-i	4ZZ-FE		11/06-11/13	6SEU14C	R134a	DCP50302	
1.6	1ZR-FAE		11/06-10/09	6SEU14C	R134a	DCP50302	
1.6 Dual VVTi	1ZR-FE		01/07-10/09	6SEU14C	R134a	DCP50302	
1.6 VVTi	1ZR-FE		07/10-05/14	6SEU14C	R134a	DCP50302	
1.8	2ZR-FE		10/06-07/14	6SEU14C	R134a	DCP50302	
2.0 D-4D	1AD-FTV		11/06-07/14	5SE12C	R134a	DCP50301	88310-42250
<b>COROLLA (E18) (13-)</b>							
1.3	1NR-FE		06/13-12/18	5TSE10C	R134a	DCP50308	
1.4 D-4D	1ND-TV		06/13-12/18	5TSE10C	R134a	DCP50309	
1.6	1ZR-FAE		06/13-12/18	6SES14C	R134a	DCP50312	
<b>COROLLA Verso (01-09)</b>							
1.6	3ZZ-FE		08/01-12/03	SCSA06C	R134a	DCP50012	88320-1A491
1.6	3ZZ-FE		04/04-03/09	5SE12C	R134a	DCP50114	88310-0F010
1.8	1ZZ-FE		04/04-03/09	5SE12C	R134a	DCP50114	88310-0F010
1.8 VVT-i	1ZZ-FE		12/01-12/03	SCSA06C	R134a	DCP50012	88320-1A491
2.0 D-4D	1CD-FTV		01/02-07/02	SCSA06C	R134a	DCP50011	88320-1A481
2.0 D-4D	1CD-FTV		04/04-08/05	5SE12C	R134a	DCP50122	88310-0F021
2.2 D-4D	2AD-FHV;2AD-FTV		10/05-03/09	5SE12C	R134a	DCP50124	88310-05120
<b>CROWN (03-08)</b>							
3.0	3GR-FE		09/04-02/08	6SBU16C	R134a	DCP51002	
3.0 4WD	3GR-FSE		09/03-02/08	6SBU16C	R134a	DCP51002	
<b>DYNA 100 (95-01)</b>							
2.4 D	2L		05/95-07/01	10PA15C	R134a	DCP50021	











				TYPE	GAS	DENSO PN	OE
<b>TOYOTA</b> <i>Continued</i>							
<b>DYNA 150 (95-01)</b>							
2.8 D	3L		05/95-08/98	10PA15C	R134a	DCP50021	
<b>DYNA 200 (95-01)</b>							
3.4 D	3B		06/95-05/99	10P30C	R134a	DCP50100	
3.7 D	14B		06/95-07/01	10P30C	R134a	DCP50100	
<b>DYNA 300 (95-02)</b>							
3.4 D	3B		06/95-05/99	10P30C	R134a	DCP50100	
3.7 D	14B		06/95-06/99	10P30C	R134a	DCP50100	
<b>DYNA (01-)</b>							
2.5 D4d	2KD-FTV		07/01-	10S15C	R134a	DCP50095	88320-25110; 88410-28200
3.0 D4d	1KD-FTV		09/06-	10S15C	R134a	DCP50095	88320-25110; 88410-28200
<b>ECHO (99-05)</b>							
1.3	2NZ-FE	Japan	04/03-08/03	SCSA06C	R134a	DCP50116	88320-52120
1.3	2NZ-FE	Japan	04/03-08/05	SCSA06C	R134a	DCP50006	88320-52090
1.3	2NZ-FE	Japan	04/03-08/05	SCSA06C	R134a	DCP50007	88320-52400
1.5	1NZ-FE	Japan	08/99-12/02	SCS06C	R134a	DCP50115	88320-52010
1.5	1NZ-FE	Japan	08/99-12/05	SCSA06C	R134a	DCP50006	88320-52090
1.5	1NZ-FE	Japan	08/99-12/05	SCSA06C	R134a	DCP50007	88320-52400
1.5	1NZ-FE	Japan	04/03-08/03	SCSA06C	R134a	DCP50116	88320-52120
1.5 VVTi	1NZ-FE	Japan	04/99-12/02	SCS06C	R134a	DCP50115	88320-52010
1.5 VVTi	1NZ-FE	Japan	04/99-08/05	SCSA06C	R134a	DCP50006	88320-52090
1.5 VVTi	1NZ-FE	Japan	04/99-08/05	SCSA06C	R134a	DCP50007	88320-52400
1.5 VVTi	1NZ-FE	Japan	04/03-08/03	SCSA06C	R134a	DCP50116	88320-52120
<b>GAIA (98-03)</b>							
2.0 VVTi	1AZ-FSE		05/98-10/03	10S17C	R134a	DCP50221	88320-44130; 88410-28200
2.0 VVTi 4WD	1AZ-FSE		05/98-10/03	10S17C	R134a	DCP50221	88320-44130; 88410-28200
<b>GT 86 (12-)</b>							
2.0	4U-GSE; FA20D		03/12-	SCSA08H	R134a; R1234yf	DCP50315	
<b>HIACE IV (95-)</b>							
2.5 D-4D	2KD-FTV		11/01-07/08	10S15C	R134a	DCP50095	88320-25110; 88410-28200
2.5 D-4D 4WD	2KD-FTV		08/01-07/08	10S15C	R134a	DCP50095	88320-25110; 88410-28200
<b>HIACE V (05-)</b>							
2.5 D-4D	2KD-FTV		06/04-07/08	10S15C	R134a	DCP50095	88320-25110; 88410-28200
2.5 D-4D 4WD	2KD-FTV		08/04-07/08	10S15C	R134a	DCP50095	88320-25110; 88410-28200
<b>HILUX II (83-05)</b>							
1.8	2Y		09/88-06/98	10PA15C	R134a	DCP50021	
2.2 4WD	4Y		11/85-12/89	10PA15C	R134a	DCP50021	
2.4 D	2L		09/88-04/05	10PA15C	R134a	DCP50021	
2.4 D 4WD	2L		09/88-12/97	10PA15C	R134a	DCP50021	
2.4 i 4WD	22RE		01/89-07/97	10PA15C	R134a	DCP50021	
2.4 i 4WD	2RZ-FE		08/97-08/01	10PA15C	R134a	DCP50021	
2.4 TD 4WD	2L-T		08/98-08/01	10PA15C	R134a	DCP50021	
2.7	3RZ-FE		11/02-08/05	10S17C	R134a	DCP50097	
<b>HILUX III (05-)</b>							
2.5 D 4WD	2KD-FTV		03/05-11/07	10S11C	R134a	DCP50092	88310-0K112
2.5 D-4D	2KD-FTV		03/05-05/15	10S11C	R134a	DCP50092	88310-0K111; 88320-0K080
2.5 D-4D 4WD	2KD-FTV		11/04-12/05	10S15C	R134a	DCP50095	88320-25110; 88410-28200
2.5 D-4D 4WD	2KD-FTV		06/06-05/15	10S11C	R134a	DCP50092	88320-0K080
3.0 D 4WD	1KD-FTV		02/05-	10S11C	R134a	DCP50092	
3.0 D-4D 4WD	1KD-FTV		08/05-12/12	10S11C	R134a	DCP50092	
<b>IQ (09-)</b>							
1.0	1KR-FE		01/09-12/15	TSB10C	R134a	DCP50125	
1.33	1NR-FE		01/09-12/15	TSB10C	R134a	DCP50126	
1.4 D-4D	1ND-TV		01/09-12/15	TSB10C	R134a	DCP50126	
<b>ISIS (04-)</b>							
1.8 VVTi	1ZZ-FE		07/04-08/14	5SE12C	R134a	DCP50120	
1.8 VVTi	2ZR-FAE		04/07-08/14	5SE12C	R134a	DCP50120	





				TYPE	GAS	DENSO PN	OE
<b>TOYOTA</b> <i>Continued</i>							
<b>LAND CRUISER (J80) (90-98)</b>							
4.2 D	1H-Z			01/90-05/93	10PA15C	R12 (Retrofit to R134a necessarily)	DCP50070 88310-60460
4.2 D	1H-Z			01/90-12/97	10PA15L	R134a	DCP50071 88310-60770
4.2 TD	1HD-T			01/90-12/97	10PA15L	R134a	DCP50071 88310-60770
4.2 TD 24V	1HD-FT			01/95-12/97	10PA15L	R134a	DCP50071 88310-60770
<b>LAND CRUISER (J100) (98-08)</b>							
4.2 TD	1HD-FTE			01/98-08/07	10PA15L	R134a	DCP50073 88310-6A010
4.2 TD	1HD-FTE	For vehicles with front and rear A/C		01/98-08/07	10PA17C	R134a	DCP50074 88310-6A100
4.7	2UZ-FE	For vehicles with A/C		01/98-08/07	10PA20C	R134a	DCP50087 88320-6068*
4.7	2UZ-FE	For vehicles with automatic climate control		02/02-08/07	10PA20C	R134a	DCP50087 88320-6068*
<b>LAND CRUISER (J200) (07-)</b>							
4.5 D V8	1VD-FTV			01/08-	10SR19C	R134a	DCP50088 88310-6A350
4.5 D-4D	1VD-FTV			09/07-	10SR19C	R134a	DCP50088 88310-6A350
4.5 D4-D	1VD-FTV			08/07-	10SR19C	R134a	DCP50088 88310-6A350
<b>LAND CRUISER / PRADO (J70) (84-06)</b>							
2.4 TD	2L-T			10/85-05/96	10PA15C	R134a	DCP50021
3.0 TD	1KZ-T			05/93-05/96	10PA15C	R134a	DCP50021
4.2 D	1H-Z			04/96-	10PA15C	R12 (Retrofit to R134a necessarily)	DCP50070 88310-60460
<b>LAND CRUISER / PRADO (J120) (02-10)</b>							
3.0 D	5L-E			09/02-02/10	10S17C	R134a	DCP50086
3.0 D-4D	1KD-FTV			09/02-08/09	10S17C	R134a	DCP50130 88320-35730; 88410-35400
3.0 D-4D	1KD-FTV	For vehicles with air conditioning front and rear		09/02-12/10	10S17C	R134a	DCP50076 88320-6A081; 88410-35400
3.0 D-4D	1KD-FTV	For vehicles with air conditioning front and rear		09/02-12/10	10S17C	R134a	DCP50085 88320-6A080; 88410-35400
3.0 D-4D	1KZ-TE			09/02-07/09	10S17C	R134a	DCP50102
4.0	1GR-FE			12/02-12/10	10S17C	R134a	DCP50103
<b>LAND CRUISER / PRADO (J150) (10-)</b>							
3.0 D-4D	1KD-FTV			08/09-	10S17C	R134a	DCP50131 88310-6A390; 88320-6A460
3.0 D-4D	1KD-FTV	For vehicles with air conditioning front and rear		08/09-	10S17C	R134a	DCP50132 88320-6A470
4.0 V6 VVTi	1GR-FE	For vehicles with automatic climate control		11/12-10/11	10S17C	R134a	DCP50132
<b>LAND CRUISER / PRADO / COLORADO (J90) (95-)</b>							
3.0 TD	1KZ-TE			04/96-12/02	10PA17C	R134a	DCP50078
<b>MARK X I (04-09)</b>							
3.0 VVTi	3GR-FSE			12/05-09/06	6SBU16C	R134a	DCP51002
<b>PICNIC (96-01)</b>							
2.0 16V	3S-FE			08/96-04/98	10PA15L	R134a	DCP50023
2.0 16V	3S-FE			08/98-09/00	10S15L	R134a	DCP50090
2.2 D	3C-TE			08/98-04/01	10S15L	R134a	DCP50090 88310-44140
<b>PLATZ (99-05)</b>							
1.0	1SZ-FE			04/99-08/05	5SE09C	R134a	DCP50001
<b>PREMIO (07-)</b>							
1.5	1NZ-FE			07/07-11/12	5SER09C	R134a	DCP50242
<b>PREVIA / ESTIMA II (00-06)</b>							
2.0 D-4D	1CD-FTV			04/03-01/06	10S17C	R134a	DCP50226 88310-28540
2.4	2AZ-FE			02/00-07/03	10S17C	R134a	DCP50081 88310-28450
2.4	2AZ-FE			08/03-02/06	10S17C	R134a	DCP50080 88310-28550
<b>PRIUS (W2) (03-09)</b>							
1.5	1NZ-FXE			09/03-12/09	ES18	R134a	DCP50503 88370-47010
<b>PRIUS (W3) (09-)</b>							
1.8 Hybrid	2ZR-FXE			06/08-12/12	ES14	R134a	DCP50502
<b>PRIUS Plus (W4) (11-)</b>							
1.8 Hybrid	2ZR-FXE			05/11-	ES27	R134a	DCP51011





				TYPE	GAS	DENSO PN	OE
<b>TOYOTA</b> <i>Continued</i>							
<b>RACTIS (05-10)</b>							
1.5 VVTi	1NZ-FE		09/05-08/10	5SER09C	R134a	DCP50249	
1.5 VVTi 4WD	1NZ-FE		09/05-08/10	5SER09C	R134a	DCP50249	
<b>RAV 4 I / FUNCRAISER (94-00)</b>							
2.0 4WD	3S-FE		09/97-06/00	10PA15L	R134a	DCP50031	88320-42050; 88410-44010
<b>RAV 4 II (00-05)</b>							
1.8	1ZZ-FE		08/00-11/05	10S15L	R134a	DCP50030	88310-42200
2.0 4WD	1AZ-FE		05/00-07/03	10S15C	R134a	DCP50033	88310-42180
2.0 D 4WD	1CD-FTV		05/01-11/05	10S15L	R134a	DCP50032	88310-42210
<b>RAV 4 III (05-)</b>							
2.0	3ZR-FAE		12/08-02/10	6SEU14C	R134a	DCP50037	88310-42310
2.0	3ZR-FAE		02/10-12/12	6SEU14C	R134a	DCP50036	88310-42320
2.0 4WD	3ZR-FAE		12/08-02/10	6SEU14C	R134a	DCP50037	88310-42310
2.0 4WD	3ZR-FAE		02/10-12/12	6SEU14C	R134a	DCP50036	88310-42320
2.0 4WD	1AZ-FE		02/06-12/08	5SE12C	R134a	DCP50035	88310-42260
2.2 D	2AD-FTV		12/08-02/10	5SE12C	R134a	DCP50301	88310-42250
2.2 D 4WD	2AD-FHV;2AD-FTV		02/06-02/10	5SE12C	R134a	DCP50301	88310-42250
2.4	2AZ-FE		11/05-12/13	6SEU16C	R134a	DCP50039	
<b>RAV 4 IV (12-)</b>							
2.0 4WD	3ZR-FAE		12/12-	6SES14C	R134a	DCP50313	
2.0 D	2WW		10/15-11/18	6SES14C	R134a	DCP50311	
2.0 D	1AD-FTV		12/12-11/18	6SES14C	R134a	DCP50311	
2.0 D 4WD	1AD-FTV		01/13-11/18	6SES14C	R134a	DCP50311	
2.0 VVT-i	3ZR-FAE		12/12-	6SES14C	R134a	DCP50313	
2.2 D 4WD	2AD-FHV; 2AD-FTV		12/12-	6SES14C	R134a	DCP50311	
<b>URBAN CRUISER (07-)</b>							
1.33	1NR-FE		01/09-03/16	5SER09C	R134a	DCP50304	
1.4 D-4D	1ND-TV		01/09-04/14	5SER09C	R134a	DCP50305	
1.4 D-4D 4WD	1ND-TV		01/09-04/14	5SER09C	R134a	DCP50305	
<b>VERSO (09-)</b>							
1.6	1ZR-FAE		04/09-11/12	6SEU14C	R134a	DCP50302	
1.6 D4-D	1WW		11/13-08/18	5SE12C	R134a	DCP50314	
1.8	2ZR-FAE		04/09-11/12	6SEU14C	R134a	DCP50228	88310-05140
2.0 D-4D	1AD-FTV		04/09-08/18	5SE12C	R134a	DCP50301	
2.2 D-4D	2AD-FHV		04/09-10/12	5SE12C	R134a	DCP50301	
2.2 D-CAT	2AD-FHV		04/09-10/12	5SE12C	R134a	DCP50301	
<b>VERSO S (10-16)</b>							
1.33	1NR-FE	For vehicles with automatic climate control	11/10-10/16	5TSE10C	R134a	DCP50252	
1.33	1NR-FE	For vehicles without automatic climate control	11/10-10/16	5TSE10C	R134a	DCP50251	
1.4 D4-D	1ND-TV		11/10-10/16	5TSE10C	R134a	DCP50251	
<b>VIOS / YARIS (07-)</b>							
1.0	1KR-FE		09/05-10/13	5SER09C	R134a	DCP50240	88310-0D23*
1.3	2NZ-FE		09/05-10/13	5SER09C	R134a	DCP50242	
1.3	2SZ-FE		09/05-10/13	5SER09C	R134a	DCP50246	
1.3 4WD	2NZ-FE		08/07-04/13	5SER09C	R134a	DCP50242	
<b>WILL Vi (00-01)</b>							
1.3	2NZ-FE		01/00-12/01	SCS06C	R134a	DCP50115	
<b>WISH (03-09)</b>							
1.8 Hi	1ZZ-FE		04/03-03/09	5SE12C	R134a	DCP50120	
<b>YARIS (99-05)</b>							
1.0	1SZ-FE	Japan	04/99-12/02	SCS06C	R134a	DCP50115	88320-52010
1.0	1SZFE;2SZFE	France	03/03-09/05	5SE09C	R134a	DCP50001	88310-0D140
1.0	2SZFE	France	03/03-09/05	5SE09C	R134a	DCP50009	88310-0D070
1.3	2SZ-FE	Japan	04/02-12/02	SCS06C	R134a	DCP50115	88320-52010
1.3	2SZ-FE	Japan	04/02-08/05	SCSA06C	R134a	DCP50006	88320-52090
1.3	2SZ-FE	Japan	04/02-08/05	SCSA06C	R134a	DCP50007	88320-52400
1.3	2NZ-FE	Japan	11/99-12/02	SCS06C	R134a	DCP50115	88320-52010
1.3	2NZ-FE	Japan	11/99-08/05	SCSA06C	R134a	DCP50006	88320-52090
1.3	2NZ-FE	Japan	11/99-08/05	SCSA06C	R134a	DCP50007	88320-52400
1.4 D-4D	1ND-TV	France	10/01-08/05	SCSA06C	R134a	DCP50004	88310-0D091
1.5	1NZ-FE	Japan	03/00-12/02	SCS06C	R134a	DCP50115	88320-52010
1.5	1NZ-FE	Japan	03/00-08/05	SCSA06C	R134a	DCP50006	88320-52090
1.5	1NZ-FE	Japan	03/00-08/05	SCSA06C	R134a	DCP50007	88320-52400
1.5	1NZ-FE	Japan	04/03-08/03	SCSA06C	R134a	DCP50116	88320-52120

				TYPE	GAS	DENSO PN	OE
<b>TOYOTA</b> <i>Continued</i>							
<b>YARIS (05-11)</b>							
1.0 GPL	1KR-FE		01/06-12/11	5SER09C	R134a	DCP50240	88310-0D23*
1.0 VVT-i	1KR-FE		08/05-12/11	5SER09C	R134a	DCP50240	88310-0D23*
1.3 4WD	2NZ-FE		08/07-11/10	5SER09C	R134a	DCP50242	
1.3 4WD	2SZ-FE		08/07-11/10	5SER09C	R134a	DCP50246	
1.3 VVT-i	2NZ-FE		08/05-11/10	5SER09C	R134a	DCP50242	
1.3 VVT-i	2SZ-FE		08/05-11/10	5SER09C	R134a	DCP50246	
1.3 VVT-i	2NZ-FE		11/05-12/12	5SER09C	R134a	DCP50242	
1.3 VVT-i	2SZ-FE		11/05-12/12	5SER09C	R134a	DCP50246	
1.33 VVT-i	1NR-FE		11/08-07/11	5SER09C	R134a	DCP50304	88310-0D320
1.33 VVT-i	1NR-FE	For cold climates	07/11-05/11	5TSE10C	R134a	DCP50250	88310-0D420
1.4 D-4D	1ND-TV		08/05-11/08	5SER09C	R134a	DCP50248	88310-0D210
1.4 D-4D	1ND-TV		11/08-07/11	5SER09C	R134a	DCP50305	88310-0D330
1.8 VVTi	2ZR-FE		01/07-06/10	5SER09C	R134a	DCP50243	88310-52601
<b>YARIS (10-)</b>							
1.0	1KR-FE		12/10-	5TSE10C	R134a	DCP50251	88310-0D380
1.0	1KR-FE	For vehicles with start-stop function	12/10-	5TSE10C	R134a; R1234yf	DCP50317	
1.0	1KR-FE	For vehicles without start-stop function	12/10-	5TSE10C	R134a; R1234yf	DCP50318	
1.3	1NR-FE; 1NR-FKE		09/11-	5TSE10C	R134a	DCP50252	88310-0D400
1.3 4WD	1NR-FE		12/10-	5TSE10C	R134a	DCP50252	88310-0D400
1.4 D	1ND-TV		09/11-	5TSE10C	R134a	DCP50251	88310-0D380
1.4 D	1ND-TV		07/14-	5TSE10C	R134a	DCP50253	88310-0D410
1.4 D	1ND-TV	For vehicles with start-stop function	09/11-	5TSE10C	R134a; R1234yf	DCP50317	
1.5 Hybrid	1NZ-FXE		03/12-	ES14	R134a	DCP50504	
<b>YARIS VERSO (99-05)</b>							
1.3	2NZ-FE		08/99-10/02	SCS06C	R134a	DCP50115	
1.3	2NZ-FE		08/03-09/05	SCSA06C	R134a	DCP50007	88310-52351
1.4 D-4D	1ND-TV		09/03-09/05	SCSA06C	R134a	DCP50005	88310-52421
1.5	1NZ-FE		03/00-09/05	SCSA06C	R134a	DCP50007	88310-52351
1.5	1NZ-FE		03/00-09/05	SCS06C	R134a	DCP50115	
1.5 4WD	1NZ-FE		03/00-09/05	SCS06C	R134a	DCP50115	
<b>VAUXHALL</b>							
<b>COMBO III (D) (11-)</b>							
1.4	A 14 FP		11/11-	5SL12C	R134a	DCP09016	
<b>CORSA II (C) (00-06)</b>							
1.2 Twinport	Z 12 XEP		07/06-10/06	5SL12C	R134a	DCP20021	
1.2 Twinport	Z 12 XEP		07/06-10/06	5SL12C	R134a	DCP20021K	
<b>CORSA III (D) (06-)</b>							
1.0	A 10 XEP; Z 10 XEP		08/06-08/14	5SL12C	R134a	DCP20021	
1.0	A 10 XEP; Z 10 XEP		08/06-08/14	5SL12C	R134a	DCP20021K	
1.0 i 12V	A 10 XEP		01/10-08/14	5SL12C	R134a	DCP20021	
1.0 i 12V	A 10 XEP		01/10-08/14	5SL12C	R134a	DCP20021K	
1.2	A 12 XEL; Z 12 XEP		08/06-	5SL12C	R134a	DCP20021	
1.2	A 12 XEL; Z 12 XEP		08/06-	5SL12C	R134a	DCP20021K	
1.2 i 16V	A 12 XER		01/10-08/14	5SL12C	R134a	DCP20021	
1.2 i 16V	A 12 XER		01/10-08/14	5SL12C	R134a	DCP20021K	
1.2 LPG	A 12 XER; Z 12 XEP		09/09-08/14	5SL12C	R134a	DCP20021	
1.2 LPG	A 12 XER; Z 12 XEP		09/09-08/14	5SL12C	R134a	DCP20021K	
1.3 CDTI	A 13 DTC; A 13 DTE; A 13 DTR; Z 13 DTE; Z 13 DTH; Z 13 DTJ		07/06-	5SL12C	R134a	DCP20022	
1.4	A 14 NEL		08/12-08/14	5SL12C	R134a	DCP20022	
1.4	Z 14 XEP		08/06-08/14	5SL12C	R134a	DCP20021	
1.4	Z 14 XEP		08/06-08/14	5SL12C	R134a	DCP20021K	
1.4	A 14 XER		01/10-08/14	5SL12C	R134a	DCP20021	
1.4	A 14 XER		01/10-08/14	5SL12C	R134a	DCP20021K	
1.4 LPG	Z 14 XEP		07/06-08/14	5SL12C	R134a	DCP20021	
1.4 LPG	Z 14 XEP		07/06-08/14	5SL12C	R134a	DCP20021K	
1.6 SRI	A 16 LEL		05/07-08/14	5SL12C	R134a	DCP20023	
1.6 VXR	A 16 LER; B 16 LER; Z 16 LER		11/06-08/14	5SL12C	R134a	DCP20023	
1.7 CDTI	A 17 DTS; Z 17 DTR		11/06-08/14	5SL12C	R134a	DCP20022	
<b>CORSA IV (E) (14-)</b>							
1.2	B 12 XEL; B 12 XER		08/14-	5SL12C	R134a	DCP20021	
1.2	B 12 XEL; B 12 XER		08/14-	5SL12C	R134a	DCP20021K	
1.4	B 14 XEJ; B 14 XEL; B 14 XER		08/14-	5SL12C	R134a	DCP20021	





				TYPE	GAS	DENSO PN	OE
<b>VAUXHALL</b> <i>Continued</i>							
<b>CORSA IV (E) (14-)</b> <i>Continued</i>							
1.4	B 14 XEJ; B 14 XEL; B 14 XER		08/14-	5SL12C	R134a	DCP20021K	
1.6 VXR	B 16 LER; B 16 LES		04/15-	5SL12C	R134a	DCP20023	
<b>OMEGA (B) (94-03)</b>							
2.5 TD	U 25 DT; U 25 TD; X 25 DT; X 25 TD		04/94-07/01	6CA17C	R134a	DCP20001	90457635
2.5 TD	U 25 DT; U 25 TD; X 25 DT; X 25 TD		04/94-07/01	7SBU16C	R134a	DCP20006	90564976
<b>VECTRA I (B) (95-03)</b>							
2.5 i GSi	X 25 XE		03/98-07/00	7SBU16C	R134a	DCP20003	24428118
2.5 i V6	X 25 XE		09/95-08/00	7SBU16C	R134a	DCP20003	24428118
2.6 i V6	Y 26 SE		09/00-03/02	7SBU16C	R134a	DCP20003	24428118
<b>ZAFIRA I (A) (98-05)</b>							
1.6 16V	X 16 XEL; Z 16 XE		04/99-08/05	7SBU16C	R134a	DCP20004	24416177
1.6 CNG	Z 16 YNG		07/03-06/05	7SBU16C	R134a	DCP20004	24416177
1.8 16V	X 18 XE1; Z 18 XE		05/99-08/05	7SBU16C	R134a	DCP20004	24416177
1.8 Dualfuel	Z 18 XE		09/00-08/05	7SBU16C	R134a	DCP20004	24430230
2.0 DI 16V	X 20 DTL		01/02-06/03	7SBU16C	R134a	DCP20005	24430319
<b>VW</b>							
<b>AMAROK (2H, S1) (10-)</b>							
2.0 BiTDI	CDCA;CNEA		03/12-	6SES14C	R134a	DCP32065	
2.0 BiTDI 4motion	CDCA;CNEA		03/12-	6SES14C	R134a	DCP32065	
2.0 TDI	CDBA;CNFA;CNFB		03/12-10/16	6SES14C	R134a	DCP32065	
2.0 TDI 4motion	CDBA;CNFA;CNFB		03/12-10/16	6SES14C	R134a	DCP32065	
2.0 TSI	CFPA		12/10-10/16	6SES14C	R134a	DCP32074	
<b>BEETLE (5C) (11-)</b>							
1.2 TSI	CBZB	For cold climates; For mild climate zones	07/11-07/19	6SEU14C	R134a	DCP02030	
1.2 TSI	CBZB	For hot climate zones	07/11-07/19	7SEU17C	R134a	DCP32045	
1.2 TSI 16V	CYVD	For cold climates; For mild climate zones	12/14-07/19	6SEU14C	R134a	DCP02050	
1.2 TSI 16V	CYVD	For hot climate zones	12/14-07/19	7SEU17C	R134a	DCP32045	
1.4 TSI	CAVD;CNWA;CTHD;CTKA	For cold climates; For mild climate zones	10/11-07/16	6SEU14C	R134a	DCP02030	
1.4 TSI	CAVD;CNWA;CTHD;CTKA	For hot climate zones	10/11-07/16	7SEU17C	R134a	DCP32045	
1.4 TSI	CZDA	For cold climates	12/14-07/19	6SEU14C	R134a	DCP02050	
1.4 TSI	CZDA	For mild climate zones; For hot climates	12/14-07/19	7SEU17C	R134a	DCP32045	
1.6 TDI	CAYC		10/11-07/16	6SEU14C	R134a	DCP32056	
1.6 TDI	CAYC	For cold climates; For mild climate zones	12/11-07/16	6SEU14C	R134a	DCP02050	
1.6 TDI	CAYC	For hot climate zones	12/11-07/16	7SEU17C	R134a	DCP32045	
2.0 TDI	CFFB;CJAA;CUUA;CUUB;CVCA;DELA	For cold climates	04/11-09/18	6SEU14C	R134a	DCP02050	
2.0 TDI	CFFB;CJAA;CUUA;CUUB;CVCA;DELA	For mild climate zones; For hot climates	04/11-09/18	7SEU17C	R134a	DCP32045	
2.0 TSI	CBFA;CCTA;CCZA;CPLA;CPPA	For cold climates; For mild climate zones	04/11-07/19	6SEU14C	R134a	DCP02050	
2.0 TSI	CBFA;CCTA;CCZA;CPLA;CPPA	For hot climate zones	04/11-07/19	7SEU17C	R134a	DCP32045	
2.0 TSI	CULC	For cold climates	12/14-09/18	6SEU14C	R134a	DCP02050	
2.0 TSI	CULC	For mild climate zones; For hot climates	12/14-09/18	7SEU17C	R134a	DCP32045	
<b>BORA (1J) (98-05)</b>							
1.6 FSI	BAD		01/02-05/05	6SEU12C	R134a	DCP27001	
<b>CADDY III (2K, 2C) (04-15)</b>							
1.2 TSI	CBZA;CBZB		09/10-05/15	6SEU14C	R134a	DCP02050	
1.2 TSI	CBZA;CBZB		09/10-05/15	7SEU17C	R134a	DCP32045	





				TYPE	GAS	DENSO PN	OE
<b>VW</b> <i>Continued</i>							
<b>CADDY III (2K, 2C) (04-15)</b> <i>Continued</i>							
1.4	BCA;BUD			03/04-08/10	7SEU17C	R134a	DCP32045
1.6	BGU; BSE; BSF			10/10-05/15	6SEU14C	R134a	DCP02030
1.6	BGU;BSE;BSF			04/04-05/15	7SEU17C	R134a	DCP32045
1.6 BiFuel	CHGA			05/11-05/15	6SEU14C	R134a	DCP02030
1.6 BiFuel	CHGA			05/11-05/15	7SEU17C	R134a	DCP32045
1.6 TDI	CAYD;CAYE			08/10-05/15	6SEU14C	R134a	DCP02050
1.6 TDI	CAYD;CAYE			08/10-05/15	7SEU17C	R134a	DCP32045
1.6 TDI	CAYD;CAYE	Isotherm vehicle		08/10-05/15	7SEU17C	R134a	DCP32045
1.9 TDI	BJB; BLS			04/04-08/10	7SEU17C	R134a	DCP32045
1.9 TDI	BJB; BLS	For cold climates;For mild climate zones		04/04-08/10	6SEU14C	R134a	DCP02030
1.9 TDI	BSU	Ch No: >2K-7-150 000, For cold climates;For mild climate zones		09/05-05/07	6SEU14C	R134a	DCP02030
1.9 TDI 4motion	BLS	For cold climates;For mild climate zones		05/08-08/10	6SEU14C	R134a	DCP02030
2.0 EcoFuel	BSX	For hot climate zones		04/06-08/10	7SEU17C	R134a	DCP32045
2.0 SDI	BDJ;BST	Ch No: >2K-8-090 000, For cold climates;For mild climate zones		03/04-01/08	6SEU14C	R134a	DCP02030
2.0 TDI	CFHC;CFHE;CFJA;CLCA;CLCB			08/10-05/15	6SEU14C	R134a	DCP02050
2.0 TDI	CFHC;CFHE;CFJA;CLCA;CLCB	Isotherm vehicle		08/10-05/15	7SEU17C	R134a	DCP32045
2.0 TDI 4motion	CFHC;CFHE;CFHF			08/10-05/15	6SEU14C	R134a	DCP02050
2.0 TDI 4motion	CFHC;CFHE;CFHF	Isotherm vehicle		08/10-05/15	7SEU17C	R134a	DCP32045
2.0 TDI 8V	BMM			09/07-08/10	6SEU14C	R134a	DCP02050
2.0 TDI 8V	BMM	Isotherm vehicle		09/07-08/10	7SEU17C	R134a	DCP32045
<b>CADDY IV (SA) (15-)</b>							
1.0 TSI	CHZG;DKRE			11/15-	6SES14C	R134a	DCP32060
1.2 TSI 16V	CYVC			06/15-	6SES14C	R134a	DCP32060
1.4 TGI CNG	CPWA			06/15-	6SES14C	R134a	DCP32060
1.4 TSI	CZCB			05/15-	6SES14C	R134a	DCP32060
1.6	CWVA			11/15-	6SES14C	R134a	DCP32060
1.6 TDI	CAYD;CAYE			05/15-	7SEU17C	R134a	DCP32045
2.0 TDI	CFHC;CLCB			05/15-	6SES14C	R134a	DCP32060
2.0 TDI	CUUB;CUUD;CUUF;DFSB;DFSC;DFSD;DFS F			05/15-	7SEU17C	R134a	DCP32045
2.0 TDI 4motion	CFHC;CFHF			05/15-	6SES14C	R134a	DCP32060
2.0 TDI 4motion	CUUE;DFSB;DFSC;DFSE			05/15-	7SEU17C	R134a	DCP32045
<b>CC (358) (11-)</b>							
1.4 TSI	CTHD	For cold climates		11/11-12/16	6SEU14C	R134a	DCP02030
1.4 TSI	CTHD	For mild climate zones; For hot climates		11/11-12/16	7SEU17C	R134a	DCP32045
1.4 TSI MultiFuel	CKMA	For cold climates		11/11-12/16	6SEU14C	R134a	DCP02030
1.4 TSI MultiFuel	CKMA	For mild climate zones; For hot climates		11/11-12/16	7SEU17C	R134a	DCP32045
1.8 TSI	CDA;CDAB	For cold climates		11/11-12/16	6SEU14C	R134a	DCP02050
1.8 TSI	CDA;CDAB	For mild climate zones; For hot climates		11/11-12/16	7SEU17C	R134a	DCP32045
2.0 TDI	CFFA;CFFB;CFGB;CFGC;CLLA	For cold climates		11/11-12/16	6SEU14C	R134a	DCP02050
2.0 TDI	CFFA;CFFB;CFGB;CFGC;CLLA	For mild climate zones; For hot climates		11/11-12/16	7SEU17C	R134a	DCP32045





				TYPE	GAS	DENSO PN	OE
<b>VW Continued</b>							
<b>CC (358) (11-) Continued</b>							
2.0 TDI 4motion	CFFB;CFGB;CFGC	For cold climates	11/11-12/16	6SEU14C	R134a	DCP02050	
2.0 TDI 4motion	CFFB;CFGB;CFGC	For mild climate zones; For hot climates	11/11-12/16	7SEU17C	R134a	DCP32045	
2.0 TSI	CBFA;CCTA;CCZB	For cold climates	11/11-12/16	6SEU14C	R134a	DCP02050	
2.0 TSI	CBFA;CCTA;CCZB	For mild climate zones; For hot climates	11/11-12/16	7SEU17C	R134a	DCP32045	
3.6 FSI 4motion	BWS	For mild climate zones; For hot climates	11/11-12/16	7SEU17C	R134a	DCP32045	
<b>CRAFTER 30-50 (2E, 2F) (06-16)</b>							
2.0 TDI	CKTB;CKTC;CKUB;CKUC;CSLA;CSLB;CSNA		05/11-12/16	7SEU17C	R134a	DCP32068	
2.0 TDI 4motion	CKUB;CSNA		11/11-12/16	7SEU17C	R134a	DCP32068	
2.5 TDI	BJJ;BJK;BJM		04/06-05/13	7SEU17C	R134a	DCP17073	HVW0002300011
2.5 TDI	BJL		04/06-05/13	10S17C	R134a	DCP32067	2E0820805
2.5 TDI	BJL;CECA	For vehicles with automatic climate control	04/06-05/13	7SEU17C	R134a	DCP17073	
<b>EOS (1F) (06-15)</b>							
1.4 TSI	CAVD;CAXA;CTHD	Ch No: 1FB006377>	11/07-08/15	7SEU17C	R134a	DCP32045	
1.6 FSI	BLF		06/06-05/08	7SEU17C	R134a	DCP32045	
2.0 FSI	BVY;BVZ		03/06-05/08	7SEU17C	R134a	DCP32045	
2.0 TDI	CFFA;CFFB	Ch No: 1FB006377>	05/08-08/15	7SEU17C	R134a	DCP32045	
2.0 TDI 8V	BMM	For cold climates;For mild climate zones	06/06-05/08	6SEU14C	R134a	DCP02030	
2.0 TFSI	CCZA	Ch No: 1FB006377>	03/06-08/15	7SEU17C	R134a	DCP32045	
2.0 TSI	CCZB	Ch No: 1FB006377>	11/09-08/15	7SEU17C	R134a	DCP32045	
3.2 V6	BUB		06/06-05/09	7SEU17C	R134a	DCP32045	
3.6 V6	CDVA		05/09-11/10	7SEU17C	R134a	DCP32045	
<b>FOX (5Z) (03-)</b>							
1.2	BMD;CHFA		04/05-12/11	6SEU14C	R134a	DCP32005	6Q0820803K
1.4	BKR		04/05-12/09	6SEU14C	R134a	DCP32020	
1.4 TDI	BNM		04/05-12/09	6SEU14C	R134a	DCP32020	
<b>GOLF IV (1J, 1E) (97-06)</b>							
1.6 FSI	BAD		01/02-06/06	6SEU12C	R134a	DCP27001	
1.9 TDI	ARL;ASZ;ATD;AXR		02/02-06/06	7SEU16C	R134a	DCP32003	
1.9 TDI	ARL;ASZ;ATD;AXR	All Climate zones	05/00-06/06	7SEU17C	R134a	DCP32002	
1.9 TDI 4motion	ARL;ASZ;ATD		02/02-06/05	7SEU16C	R134a	DCP32003	
1.9 TDI 4motion	ARL;ASZ;ATD	All Climate zones	02/00-06/06	7SEU17C	R134a	DCP32002	
<b>GOLF Plus (5M, 521) (05-14)</b>							
1.2 TSI	CBZA;CBZB		11/09-12/13	7SEU17C	R134a	DCP32045	
1.4 16V	BCA		01/05-05/06	7SEU16C	R134a	DCP32003	1K0820803A
1.4 16V	BCA	All Climate zones	01/05-11/06	7SEU17C	R134a	DCP32002	
1.4 16V	BCA	For hot climate zones	01/05-05/06	7SEU17C	R134a	DCP32045	
1.4 16V	BUD		05/06-12/13	7SEU17C	R134a	DCP32045	
1.4 FSI	BLN		07/05-05/06	7SEU16C	R134a	DCP32003	1K0820803A
1.4 FSI	BLN	All Climate zones	07/05-11/06	7SEU17C	R134a	DCP32002	
1.4 FSI	BLN	For hot climate zones	07/05-05/06	7SEU17C	R134a	DCP32045	
1.4 TSI	BLG;BMY;CAVD;CAXA		05/06-12/13	7SEU17C	R134a	DCP32045	
1.6	BSE; BSF; CCSA; CMXA		05/05-12/13	7SEU17C	R134a	DCP32045	
1.6 BiFuel	CHGA		05/09-12/13	6SEU14C	R134a	DCP02030	
1.6 FSI	BLF		12/04-05/08	7SEU16C	R134a	DCP32003	1K0820803A
1.6 FSI	BLF	All Climate zones	12/04-05/08	7SEU17C	R134a	DCP32002	
1.6 FSI	BLF	For hot climate zones	12/04-05/08	7SEU17C	R134a	DCP32045	





				TYPE	GAS	DENSO PN	OE
<b>VW Continued</b>							
<b>GOLF Plus (5M, 521) (05-14) Continued</b>							
1.6 MultiFuel	CHGA	For cold climates;For mild climate zones	05/09-12/13	6SEU14C	R134a	DCP02030	
1.6 MultiFuel	CHGA	For hot climate zones	05/09-12/13	7SEU17C	R134a	DCP32045	
1.6 TDI	CAYB;CAYC	For cold climates;For mild climate zones	02/09-12/13	6SEU14C	R134a	DCP02050	
1.6 TDI	CAYB;CAYC	For hot climate zones	02/09-12/13	7SEU17C	R134a	DCP32045	
1.9 TDI	BKC;BLS;BXE;BXF		05/07-01/09	7SEU17C	R134a	DCP32045	
2.0 FSI	BLR; BLY; BVY; BVZ		05/05-06/08	7SEU17C	R134a	DCP32045	
2.0 TDI	AZV		05/07-05/09	7SEU17C	R134a	DCP32045	
2.0 TDI	BEE	Ch No: 1K-8-500001>	05/06-05/07	7SEU17C	R134a	DCP32045	
2.0 TDI	BKD; CBDB; CFHC	For cold climates;For mild climate zones	01/05-12/13	6SEU14C	R134a	DCP02050	
2.0 TDI	BKD; CBDB; CFHC	For hot climate zones	01/05-12/13	7SEU17C	R134a	DCP32045	
2.0 TDI	CBDC; CLCA	For cold climates	01/09-12/13	6SEU14C	R134a	DCP02050	
2.0 TDI	CBDC; CLCA	For mild climate zones; For hot climates	01/09-12/13	7SEU17C	R134a	DCP32045	
2.0 TDI 8V	BMM		12/05-05/11	7SEU17C	R134a	DCP32045	
<b>GOLF Sportsvan (AM1) (14-)</b>							
1.0 TSI	CHZD; DKRF		05/15-	6SES14C	R134a	DCP32060	
1.2 TSI 16V	CYVA;CYVB		04/14-	6SES14C	R134a	DCP32060	
1.4 TSI	CPVB;CZCA;CZDA		02/14-	6SES14C	R134a	DCP32060	
1.4 TSI MultiFuel	CPVB		04/14-	6SES14C	R134a	DCP32060	
1.6	CWVA		05/14-	6SES14C	R134a	DCP32060	
1.6 TDI	CRKA;CRKB;CXXA;CXXB;DBKA;DDYA;DDYB; DGTE		02/14-	6SES14C	R134a	DCP32060	
2.0 TDI	CRLB;CRLD;CRVA;DCYA;DCYB;DFGA		02/14-	6SES14C	R134a	DCP32060	
<b>GOLF V (1K) (03-09)</b>							
1.4	BUD		06/07-07/09	7SEU17C	R134a	DCP32045	
1.4 16V	BCA;BUD		10/03-11/08	7SEU17C	R134a	DCP32045	
1.4 FSI	BKG; BLN		10/03-07/06	7SEU17C	R134a	DCP32045	1K0820859E;1K0820859M;1K0820859S
1.4 TSI	BLG;BMY;CAVD;CAXA		11/05-07/09	7SEU17C	R134a	DCP32045	1K0820859E;1K0820859M;1K0820859S
1.6	BGU;BSE;BSF;CCSA		01/04-11/08	7SEU17C	R134a	DCP32045	
1.6 FSI	BAG; BLF; BLP		10/03-07/08	7SEU17C	R134a	DCP32045	
1.6 MultiFuel	CCSA		10/07-11/08	6SEU14C	R134a	DCP02030	
1.9 TDI	BKC;BLS;BRU;BXE;BXF		10/03-11/08	7SEU17C	R134a	DCP32045	
1.9 TDI	BLS; BXE	For cold climates;For mild climate zones	06/07-11/08	6SEU14C	R134a	DCP02030	
1.9 TDI 4motion	BKC; BLS; BXE		08/04-11/08	7SEU17C	R134a	DCP32045	
1.9 TDI 4motion	BLS	For cold climates;For mild climate zones	01/08-07/09	6SEU14C	R134a	DCP02030	
2.0	BWA	For cold climates;For mild climate zones	06/07-03/09	6SEU14C	R134a	DCP02030	
2.0 FSI	AXW; BLR; BLX; BLY; BVX; BVY; BVZ		01/04-11/08	7SEU17C	R134a	DCP32045	
2.0 FSI 4motion	BLX; BVX		06/05-05/07	7SEU17C	R134a	DCP32045	
2.0 GTI	AXX; BPY; BWA; CAWB; CBFA; CCTA	Ch No: 1K-4-000 001>	10/04-02/09	7SEU17C	R134a	DCP32045	
2.0 GTI	BYD		09/06-12/08	7SEU17C	R134a	DCP32045	
2.0 SDI	BDK		06/05-11/08	7SEU17C	R134a	DCP32045	
2.0 TDI	AZV	For cold climates;For mild climate zones	06/07-05/08	6SEU14C	R134a	DCP02030	
2.0 TDI	AZV;BKD;BMN;CBDB		10/03-07/09	7SEU17C	R134a	DCP32045	
2.0 TDI 4motion	BKD		06/05-11/08	7SEU17C	R134a	DCP32045	
2.0 TDI 8V	BMM		12/04-11/08	7SEU17C	R134a	DCP32045	











				TYPE	GAS	DENSO PN	OE
<b>VW</b> <i>Continued</i>							
<b>GOLF V (1K) (03-09)</b> <i>Continued</i>							
2.0 TDI 8V	BMM	For cold climates;For mild climate zones	06/07-05/08	6SEU14C	R134a	DCP02030	
2.0 TDI 8V 4motion	BMM		08/04-11/08	7SEU17C	R134a	DCP32045	
3.2 R32 4motion	BUB	For cold climates;For mild climate zones	11/05-11/08	6SEU14C	R134a	DCP02030	
<b>GOLF VI (5K, AJ5) (08-14)</b>							
1.2 TSI	CBZA	For mild climate zones;For hot climates	07/10-07/13	7SEU17C	R134a	DCP32045	
1.2 TSI	CBZA;CBZB	For cold climates;For mild climate zones	11/08-07/13	6SEU14C	R134a	DCP02030	
1.2 TSI	CBZA;CBZB	For hot climate zones	11/08-07/13	7SEU17C	R134a	DCP32045	
1.4	BUD;CGGA	For cold climates;For mild climate zones	10/08-07/13	6SEU14C	R134a	DCP02030	
1.4	BUD;CGGA	For hot climate zones	10/08-07/13	7SEU17C	R134a	DCP32045	
1.4 TSI	CAVD;CAXA;CNWA;CTHD	For cold climates;For mild climate zones	10/08-07/13	6SEU14C	R134a	DCP02030	
1.4 TSI	CAVD;CAXA;CNWA;CTHD	For hot climate zones	10/08-07/13	7SEU17C	R134a	DCP32045	
1.6	BSE;BSF;CCSA;CMXA	For cold climates;For mild climate zones	10/08-07/13	6SEU14C	R134a	DCP02030	
1.6	BSE;BSF;CCSA;CMXA	For hot climate zones	10/08-07/13	7SEU17C	R134a	DCP32045	
1.6 BiFuel	CHGA	For cold climates;For mild climate zones	03/09-11/12	6SEU14C	R134a	DCP02030	
1.6 BiFuel	CHGA	For hot climate zones	03/09-11/12	7SEU17C	R134a	DCP32045	
1.6 MultiFuel	CCSA;CMXA	For cold climates;For mild climate zones	10/08-07/13	6SEU14C	R134a	DCP02030	
1.6 MultiFuel	CCSA;CMXA	For hot climate zones	10/08-07/13	7SEU17C	R134a	DCP32045	
1.6 TDI	CAYB;CAYC		02/09-07/13	6SEU14C	R134a	DCP02050	
1.6 TDI 4motion	CAYC	For cold climates;For mild climate zones	07/09-07/13	6SEU14C	R134a	DCP02050	
1.6 TDI 4motion	CAYC	For hot climate zones	07/09-07/13	7SEU17C	R134a	DCP32045	
1.8 TSI	CDA A	For cold climates;For mild climate zones	06/09-01/11	6SEU14C	R134a	DCP02030	
1.8 TSI	CDA A	For hot climate zones	06/09-01/11	7SEU17C	R134a	DCP32045	
2.0 GTi	CBFA; CCTA; CCZA		06/09-11/13	7SEU17C	R134a	DCP32045	
2.0 GTi	CCZB	For cold climates;For mild climate zones	04/09-11/12	6SEU14C	R134a	DCP02050	
2.0 GTi	CCZB;CDLG	For hot climate zones	04/09-11/12	7SEU17C	R134a	DCP32045	
2.0 GTi	CDLG	For cold climates	05/11-11/12	6SEU14C	R134a	DCP02030	
2.0 GTi	CDLG	For mild climatic zones	05/11-11/12	6SEU14C	R134a	DCP02050	
2.0 R 4motion	CDLA		11/09-05/11	7SEU17C	R134a	DCP32045	
2.0 R 4motion	CDLC;CDLF;CRZA	For cold climates	11/09-11/13	6SEU14C	R134a	DCP02030	
2.0 R 4motion	CDLC;CDLF;CRZA	For hot climate zones	11/09-11/13	7SEU17C	R134a	DCP32045	
2.0 R 4motion	CDLC;CDLF;CRZA	For mild climatic zones	11/09-11/13	6SEU14C	R134a	DCP02050	
2.0 TDI	CBAA;CBAB;CBBB;CBDA;CBDB;CBDC;CFFA;CFFB;CFGB;CFHB;CFHC;CJAA;CLCA;CLCB		10/08-07/13	6SEU14C	R134a	DCP02050	





				TYPE	GAS	DENSO PN	OE
<b>VW</b> <i>Continued</i>							
<b>GOLF VI (5K, AJ5) (08-14)</b> <i>Continued</i>							
2.0 TDI 4motion	CBAB; CFFB		05/09-11/12	6SEU14C	R134a	DCP02050	
2.0 TSI	CCZA	For cold climates	07/09-07/13	6SEU14C	R134a	DCP02030	
2.0 TSI	CCZA	For hot climate zones	07/09-07/13	7SEU17C	R134a	DCP32045	
2.0 TSI	CCZA	For mild climatic zones	07/09-07/13	6SEU14C	R134a	DCP02050	
<b>GOLF VI Convertible (517) (11-16)</b>							
1.2 TSI	CBZB	For cold climates; For mild climate zones	03/11-05/16	6SEU14C	R134a	DCP02030	
1.2 TSI	CBZB	For hot climate zones	03/11-05/16	7SEU17C	R134a	DCP32045	
1.2 TSI 16V	CJZA; CYVD	For cold climates; For mild climate zones	11/13-05/16	6SEU14C	R134a	DCP02030	
1.2 TSI 16V	CJZA; CYVD	For hot climate zones	11/13-05/16	7SEU17C	R134a	DCP32045	
1.4 TSI	CAVD; CAXA; CNWA; CTHD; CTKA		03/11-05/16	6SEU14C	R134a	DCP02030	
1.4 TSI	CHPB; CXSB; CZCA; CZDA	For cold climates; For mild climate zones	11/13-05/16	6SEU14C	R134a	DCP02030	
1.4 TSI	CHPB; CXSB; CZCA; CZDA	For hot climate zones	11/13-05/16	7SEU17C	R134a	DCP32045	
1.6 TDI	CAYC	For cold climates; For mild climate zones	03/11-05/16	6SEU14C	R134a	DCP02050	
1.6 TDI	CAYC	For hot climate zones	03/11-05/16	7SEU17C	R134a	DCP32045	
2.0 GTI	CCZB	For cold climates	05/12-05/16	6SEU14C	R134a	DCP02050	
2.0 GTI	CCZB	For mild climate zones; For hot climates	05/12-05/16	7SEU17C	R134a	DCP32045	
2.0 R	CDLA	For cold climates	01/13-05/16	6SEU14C	R134a	DCP02050	
2.0 R	CDLA	For mild climate zones; For hot climates	01/13-05/16	7SEU17C	R134a	DCP32045	
2.0 TDI	CFHC		11/11-05/16	6SEU14C	R134a	DCP02050	
2.0 TDI	CUUA; CUUB	For cold climates; For mild climate zones	11/13-05/16	6SEU14C	R134a	DCP02030	
2.0 TDI	CUUA; CUUB	For hot climate zones	11/13-05/16	7SEU17C	R134a	DCP32045	
2.0 TSI	CULC	For cold climates; For mild climate zones	11/13-05/16	6SEU14C	R134a	DCP02050	
2.0 TSI	CULC	For hot climate zones	11/13-05/16	7SEU17C	R134a	DCP32045	
<b>GOLF VII (5G, BA5) (12-)</b>							
1.0 TSI	CHZC; CHZK; DKLB		11/16-	6SES14C	R134a; R1234yf	DCP32080	
1.0 TSI	CHZD; DKRF		05/15-	6SES14C	R134a	DCP32060	
1.2 TSI 16V	CJZA; CJZB; CYVA; CYVB		08/12-	6SES14C	R134a	DCP32060	
1.4 TGI CNG	CPWA		06/13-	6SES14C	R134a	DCP32060	
1.4 TSI	CHPA; CHPB; CMBA; CPTA; CPVA; CPVB; CXSA; CZCA; CZDA; CZDD; CZEA; DGXA		08/12-	6SES14C	R134a	DCP32060	
1.4 TSI MultiFuel	CPVA; CPVB		04/13-	6SES14C	R134a	DCP32060	
1.5 TSI	DACA; DADA; DPBA; DPCA		04/17-	6SES14C	R134a; R1234yf	DCP32080	
1.6	CWVA		05/14-	6SES14C	R134a	DCP32060	
1.6 TDI	CLHA; CLHB; CRKA; CRKB; CXXA; CXXB; DBKA; DDYB		08/12-	6SES14C	R134a	DCP32060	
1.6 TDI	DDYA; DGTE		11/16-	6SES14C	R134a; R1234yf	DCP32080	
1.6 TDI 4motion	CLHA; CRKB; CXXB		11/12-	6SES14C	R134a	DCP32060	
1.8 TSI 4motion	CJSB		12/14-	6SES14C	R134a	DCP32060	
1.8 TSI 4motion	CJSB		11/16-	6SES14C	R134a; R1234yf	DCP32080	
2.0 GTD	CUNA; DGCA; DJGA		04/13-	6SES14C	R134a	DCP32060	





				TYPE	GAS	DENSO PN	OE
<b>VW Continued</b>							
<b>GOLF VII (5G, BA5) (12-) Continued</b>							
2.0 GTI	CHHA;CHHB;CNTA;CNTC;CXCA;CXCB;CXDA;CXDB		04/13-	6SES14C	R134a	DCP32060	
2.0 GTI	DKTB; DLBA		03/17-	6SES14C	R134a; R1234yf	DCP32080	
2.0 GTI Clubsport	CJXE		02/16-	6SES14C	R134a; R1234yf	DCP32080	
2.0 GTI Clubsport S	CJXG		09/16-	6SES14C	R134a	DCP32060	
2.0 R 360S 4motion			09/16-	6SES14C	R134a; R1234yf	DCP32080	
2.0 R 4motion	CJXB;CJXC;CJXD;DJHB;DNUC;DNUJ		11/13-	6SES14C	R134a	DCP32060	
2.0 R 4motion	CJXD;CJXG;DJHA;DJHB		12/16-	6SES14C	R134a; R1234yf	DCP32080	
2.0 TDI	CKFC;CRBB;CRBC;CRLB;CRLD;CRMB;CRUA;CRVA;CRVC;CYKB;DCYA;DCYB;DEJA;DEJB;DFGA		08/12-	6SES14C	R134a	DCP32060	
2.0 TDI 4motion	CKFC;CRBC;CRLB;CRMB;CUNA;DCYA;DGCA;DJGA		11/12-	6SES14C	R134a	DCP32060	
<b>JETTA III (1K2) (05-10)</b>							
1.4 TSI	BLG;BMY		07/06-06/08	7SEU17C	R134a	DCP32045	
1.4 TSI	CAVD;CAXA	For cold climates;For mild climate zones	05/07-10/10	6SEU14C	R134a	DCP02030	
1.4 TSI	CAVD;CAXA	For hot climate zones	05/07-10/10	7SEU17C	R134a	DCP32045	
1.6	BGU; BSE; BSF; CCSA	For cold climates;For mild climate zones	10/05-10/10	6SEU14C	R134a	DCP02030	
1.6	BGU; BSE; BSF; CCSA	For hot climate zones	10/05-10/10	7SEU17C	R134a	DCP32045	
1.6 FSI	BLF		09/05-06/08	7SEU17C	R134a	DCP32045	
1.6 MultiFuel	CCSA	For cold climates;For mild climate zones	01/08-10/10	6SEU14C	R134a	DCP02030	
1.6 MultiFuel	CCSA	For hot climate zones	01/08-10/10	7SEU17C	R134a	DCP32045	
1.6 TDI	CAYB;CAYC		06/09-10/10	7SEU17C	R134a	DCP32045	
1.9 TDI	BKC; BLS; BXE	For cold climates;For mild climate zones	08/05-10/10	6SEU14C	R134a	DCP02030	
1.9 TDI	BKC; BLS; BXE	For hot climate zones	08/05-10/10	7SEU17C	R134a	DCP32045	
2.0 FSI	BLR; BLX; BLY; BVY; BVZ		08/05-06/08	7SEU17C	R134a	DCP32045	
2.0 TDI	AZV;BKD;CBDB;CBEA;CJAA	For cold climates;For mild climate zones	08/05-10/10	6SEU14C	R134a	DCP02030	
2.0 TDI	BMN; CEGA		10/06-10/10	7SEU17C	R134a	DCP32045	
2.0 TDI 8V	BMM		06/06-06/08	7SEU17C	R134a	DCP32045	
2.0 TFSI	AXX; BPY; BWA; CAWB; CBFA; CCTA; CCZA	For cold climates;For mild climate zones	10/05-10/10	6SEU14C	R134a	DCP02030	
2.0 TFSI	AXX; BPY; BWA; CAWB; CBFA; CCTA; CCZA	For hot climate zones	10/05-10/10	7SEU17C	R134a	DCP32045	
<b>JETTA IV (162) (10-)</b>							
1.2 TSI	CBZB		10/10-	6SEU14C	R134a	DCP02030	
1.4 TSI	CAVA;CAVD;CTHA;CTHD	For cold climates;For mild climate zones	04/11-	6SEU14C	R134a	DCP02030	
1.4 TSI	CAVA;CAVD;CTHA;CTHD	For hot climate zones	04/11-	7SEU17C	R134a	DCP32045	
1.4 TSI	CAXA		05/11-	6SEU14C	R134a	DCP02030	
1.4 TSI	CZCA;CZDA;CZTA	For cold climates;For mild climate zones	08/14-	6SEU14C	R134a	DCP02050	
1.4 TSI	CZCA;CZDA;CZTA	For hot climate zones	08/14-	7SEU17C	R134a	DCP32045	
1.6	CFNA; CLRA	For cold climates;For mild climate zones	12/11-	6SEU14C	R134a	DCP02050	

				TYPE	GAS	DENSO PN	OE
<b>VW Continued</b>							
<b>JETTA IV (162) (10-) Continued</b>							
1.6	CFNA; CLRA	For hot climate zones	12/11-	7SEU17C	R134a	DCP32045	
1.6	CFNB		03/13-	6SEU14C	R134a	DCP02050	
1.6 TDI	CAYC		04/10-07/14	7SEU17C	R134a	DCP32045	
1.8 TSI	CPKA; CPRA	For cold climates; For mild climate zones	07/14-	6SEU14C	R134a	DCP02050	
1.8 TSI	CPKA; CPRA	For hot climate zones	07/14-	7SEU17C	R134a	DCP32045	
2.0 TDI	CFFB; CFHC; CJAA; CLCA; CLCB; CUUA		10/10-	7SEU17C	R134a	DCP32045	
2.0 TDI	CUUB; DELA; DGMA		08/14-	6SEU14C	R134a	DCP02050	
2.0 TSI	CBFA; CCTA; CCZA		12/10-	6SEU14C	R134a	DCP02050	
2.0 TSI	CPLA; CPPA	For cold climates; For mild climate zones	12/12-12/17	6SEU14C	R134a	DCP02050	
2.0 TSI	CPLA; CPPA	For hot climate zones	12/12-12/17	7SEU17C	R134a	DCP32045	
<b>LUPU (6X, 6E) (98-05)</b>							
1.4 FSI	ARR		02/01-11/03	6SEU12C	R134a	DCP27001	
<b>MULTIVAN V (7H, 7E) (03-)</b>							
2.0	AXA		11/03-08/15	6SES14C	R134a	DCP32065	
2.0	AXA		11/03-08/15	7SEU17C	R134a	DCP32070	
2.0 BiTDI	CFCA	Ch No: 7HZ*-000001; 7JZ*-000001>, For vehicles with A/C	01/12-08/15	6SEU14C	R134a	DCP32066	
2.0 BiTDI	CFCA	Ch No: 7HZA-200001; 7HZ*-000001; 7JZ*-000001>, For vehicles with A/C	09/09-12/11	6SEU14C	R134a	DCP32069	
2.0 BiTDI	CFCA	For vehicles with front and rear A/C	09/09-08/15	7SEU17C	R134a	DCP32050	
2.0 BiTDI 4motion	CFCA	Ch No: 7HZ*-000001; 7JZ*-000001>, For vehicles with A/C	01/12-08/15	6SEU14C	R134a	DCP32066	
2.0 BiTDI 4motion	CFCA	Ch No: 7HZA-200001; 7HZ*-000001; 7JZ*-000001>, For vehicles with A/C	09/09-12/11	6SEU14C	R134a	DCP32069	
2.0 BiTDI 4motion	CFCA	For vehicles with front and rear A/C	09/09-08/15	7SEU17C	R134a	DCP32050	
2.0 TDI	CAAA; CAAB; CAAC; CAAD; CAAE; CCHA; CCHB	Ch No: 7HZ*-000001; 7JZ*-000001>, For vehicles with A/C	01/12-08/15	6SEU14C	R134a	DCP32066	
2.0 TDI	CAAA; CAAB; CAAC; CAAD; CAAE; CCHA; CCHB	Ch No: 7HZA-200001; 7HZ*-000001; 7JZ*-000001>, For vehicles with A/C	09/09-12/11	6SEU14C	R134a	DCP32069	
2.0 TDI	CAAA; CAAB; CAAC; CAAD; CAAE; CCHA; CCHB	For vehicles with front and rear A/C	09/09-08/15	7SEU17C	R134a	DCP32050	
2.0 TDI 4motion	CAAC; CAAE; CCHA; CCHB	Ch No: 7HZ*-000001; 7JZ*-000001>, For vehicles with A/C	01/12-08/15	6SEU14C	R134a	DCP32066	
2.0 TDI 4motion	CAAC; CAAE; CCHA; CCHB	Ch No: 7HZA-200001; 7HZ*-000001; 7JZ*-000001>, For vehicles with A/C	09/09-12/11	6SEU14C	R134a	DCP32069	
2.0 TDI 4motion	CAAC; CAAE; CCHA; CCHB	For vehicles with front and rear A/C	09/09-08/15	7SEU17C	R134a	DCP32050	
2.0 TSI	CJKA; CJKB	For vehicles with A/C	01/12-08/15	6SES14C	R134a	DCP32065	
2.0 TSI	CJKA; CJKB	For vehicles with front and rear A/C	01/12-08/15	7SEU17C	R134a	DCP32072	





				TYPE	GAS	DENSO PN	OE
<b>VW Continued</b>							
<b>MULTIVAN V (7H, 7E) (03-) Continued</b>							
2.0 TSI 4motion	CJKA	For vehicles with A/C	01/12-08/15	6SES14C	R134a	DCP32065	
2.0 TSI 4motion	CJKA	For vehicles with front and rear A/C	01/12-08/15	7SEU17C	R134a	DCP32072	
2.5 TDI	AXD;AXE;BLJ;BNZ;BPC		04/03-11/09	7SEU17C	R134a	DCP32006	
2.5 TDI	AXD;AXE;BLJ;BNZ;BPC	With freewheel pulley & rubber coupling kit	04/03-11/09	7SEU17C	R134a	DCP32006K	
2.5 TDI 4motion	AXD;AXE;BNZ;BPC		07/04-11/09	7SEU17C	R134a	DCP32006	
2.5 TDI 4motion	AXD;AXE;BNZ;BPC	With freewheel pulley & rubber coupling kit	07/04-11/09	7SEU17C	R134a	DCP32006K	
<b>MULTIVAN VI (SG) (15-)</b>							
2.0 TDI	CAAB;CAAC;CFCA;CXEB;CXFA;CXGA;CXG B; CXHA		04/15-	7SEU17C	R134a	DCP32073	
2.0 TDI 4motion	CAAC;CFCA;CXEB;CXFA;CXHA		06/15-	7SEU17C	R134a	DCP32073	
2.0 TSI	CJKA;CJKB		04/15-	7SEU17C	R134a; R1234yf	DCP32076	
2.0 TSI 4motion	CJKA		06/15-	7SEU17C	R134a; R1234yf	DCP32076	
<b>NEW BEETLE (9C, 1C, 1Y) (98-10)</b>							
2.5	BPR;BPS		07/05-09/10	7SEU17C	R134a	DCP32045	
<b>PASSAT (3B2, 3B5) (96-01)</b>							
1.6	AHL;ANA;ARM		10/96-11/00	7SBU16C	R134a	DCP02006	8D0260805B
1.8 T	AEB;ANB;APU		09/00-11/00	7SBU16C	R134a	DCP02006	
1.9 TDI	AJM;ATJ;AVB		01/99-11/00	7SBU16C	R134a	DCP02006	
1.9 TDI 4motion	ATJ		08/99-11/00	7SBU16C	R134a	DCP02006	8D0260805B
1.9 TDI Syncro/4motion	AVG		08/99-11/00	7SBU16C	R134a	DCP02006	8D0260805B
2.3 VR5	AGZ		06/97-11/00	7SBU16C	R134a	DCP32001	
2.3 VR5 Syncro/4motion	AGZ		10/97-11/00	7SBU16C	R134a	DCP32001	
2.5 TDI	AFB;AKN		07/98-11/00	7SBU16C	R134a	DCP02004	
2.5 TDI	AKN		05/99-11/00	7SBU16C	R134a	DCP02005	4B0260805B
2.5 TDI Syncro/4motion	AFB		09/99-11/00	7SBU16C	R134a	DCP02006	8D0260805B
2.5 TDI Syncro/4motion	AFB;AKN		12/98-11/00	7SBU16C	R134a	DCP02004	4B0260805C
2.8 Syncro	AGE		05/97-09/99	7SBU16C	R134a	DCP02005	
2.8 V6	ACK;AGE;AHA;APR;AQD;ATX		05/97-11/00	7SBU16C	R134a	DCP02005	
2.8 V6 4motion	ATX		09/99-11/00	7SBU16C	R134a	DCP02005	
2.8 V6 Syncro/4motion	ACK;AHA;ALG;APR;AQD		05/97-11/00	7SBU16C	R134a	DCP02005	
<b>PASSAT (3B3, 3B6) (00-05)</b>							
1.6	ALZ		11/00-05/05	7SBU16C	R134a	DCP02006	
1.8 T	AWM		02/01-08/05	7SBU16C	R134a	DCP02006	
1.8 T 20V	AWL;AWT		11/00-05/05	7SBU16C	R134a	DCP02006	
1.8 T 4motion	AWM		03/01-05/05	7SBU16C	R134a	DCP02006	
1.9 TDI	AVB;AVF;AWX		11/00-05/05	7SBU16C	R134a	DCP02006	
1.9 TDI 4motion	AVF		11/00-05/05	7SBU16C	R134a	DCP02006	
2.0	ALT;AZM		11/00-05/05	7SBU16C	R134a	DCP02006	
2.0 4motion	AZM		11/00-05/05	7SBU16C	R134a	DCP02006	
2.0 TDI 8V	BGW		12/03-05/05	7SBU16C	R134a	DCP02006	8D0260805B
2.3 V5	AZX		11/00-05/05	7SBU16C	R134a	DCP32001	
2.3 V5 4motion	AZX		11/00-05/05	7SBU16C	R134a	DCP32001	
2.3 VR5	AZX		11/00-05/05	7SBU16C	R134a	DCP32001	
2.3 VR5 4motion	AZX		11/00-05/05	7SBU16C	R134a	DCP32001	
2.5 TDI	AKN;BDG		11/00-05/05	7SBU16C	R134a	DCP02004	
2.5 TDI 4motion	AKN;BAU;BDH		11/00-05/05	7SBU16C	R134a	DCP02004	
2.8	AMX; ATQ		05/02-05/03	7SBU16C	R134a	DCP02005	
2.8 4motion	AMX;ATQ		11/00-05/05	7SBU16C	R134a	DCP02005	
4.0 W8 4motion	BDN;BDP		09/01-09/04	7SEU16C	R134a	DCP32052	
<b>PASSAT (3C) (05-11)</b>							
1.4 TSI	CAXA		05/07-11/10	7SEU17C	R134a	DCP32045	
1.4 TSI EcoFuel	CDGA		01/09-11/10	7SEU17C	R134a	DCP32045	
1.6	BSE;BSF		05/05-11/10	7SEU17C	R134a	DCP32045	
1.6 FSI	BLF		03/05-06/08	7SEU17C	R134a	DCP32045	
1.6 TDI	CAYC	For cold climates	08/09-11/10	6SEU14C	R134a	DCP02050	
1.6 TDI	CAYC	For mild climate zones; For hot climates	08/09-11/10	7SEU17C	R134a	DCP32045	
1.8 TSI	BZB;CDAA;CDAB;CGYA		05/07-10/11	7SEU17C	R134a	DCP32045	
1.9 TDI	BKC;BLS;BXE	For cold climates	03/05-11/10	6SEU14C	R134a	DCP02050	





				TYPE	GAS	DENSO PN	OE
<b>VW</b> <i>Continued</i>							
<b>PASSAT (3C) (05-11)</b> <i>Continued</i>							
1.9 TDI	BKC;BLS;BXE	For mild climate zones; For hot climates	03/05-11/10	7SEU17C	R134a	DCP32045	
2.0 BlueTDI	CBAC		01/09-11/10	7SEU17C	R134a	DCP32045	
2.0 FSI	AXX;BLR;BLY;BPY;BVY;BVZ;BWA;CAWB;C BFA; CCTA;CCTB;CCZA		03/05-11/10	7SEU17C	R134a	DCP32045	
2.0 FSI 4motion	BLX;BLY;BVX		09/05-11/10	7SEU17C	R134a	DCP32045	
2.0 TDI	BKP;BWV;CBAB	For cold climates	03/05-11/10	6SEU14C	R134a	DCP02050	
2.0 TDI	BKP;BWV;CBAB	For mild climate zones; For hot climates	03/05-11/10	7SEU17C	R134a	DCP32045	
2.0 TDI	BMA;BMR;BUZ;BVE;BWV;CBAA;CBBB;CBD C		03/05-11/10	7SEU17C	R134a	DCP32045	
2.0 TDI 4motion	BKP;CBAB		03/05-11/10	7SEU17C	R134a	DCP32045	
2.0 TDI 4motion	CBBB	For cold climates	05/09-11/10	6SEU14C	R134a	DCP02050	
2.0 TDI 4motion	CBBB	For mild climate zones; For hot climates	05/09-11/10	7SEU17C	R134a	DCP32045	
2.0 TDI 8V	BMP		03/05-05/09	7SEU17C	R134a	DCP32045	
2.0 TDI 8V 4motion	BMP		03/05-05/09	7SEU17C	R134a	DCP32045	
3.2 FSI	AXZ	For cold climates	11/05-12/11	6SEU14C	R134a	DCP02030	
3.2 FSI	AXZ	For mild climate zones; For hot climates	11/05-12/11	7SEU17C	R134a	DCP32045	
3.2 FSI 4motion	AXZ	For cold climates	11/05-11/10	6SEU14C	R134a	DCP02030	
3.2 FSI 4motion	AXZ	For mild climate zones; For hot climates	11/05-11/10	7SEU17C	R134a	DCP32045	
3.6 R36 4motion	BWS		04/07-11/10	7SEU17C	R134a	DCP32045	
<b>PASSAT (3G) (14-)</b>							
1.4 TSI	CZCA;CZDA;CZEA		11/14-	6SES14C	R134a	DCP32060	
1.4 TSI	CZCA;CZDA;CZEA		11/14-	6SES14C	R134a; R1234yf	DCP32080	
1.4 TSI 4motion	CZEA		02/15-	6SES14C	R134a	DCP32060	
1.4 TSI 4motion	CZEA		02/15-	6SES14C	R134a; R1234yf	DCP32080	
1.6 TDI	DCXA;DCZA		08/14-	6SES14C	R134a	DCP32060	
1.6 TDI	DCXA;DCZA		08/14-	6SES14C	R134a; R1234yf	DCP32080	
1.8 TSI	CJSA;CJSC		02/15-	6SES14C	R134a	DCP32060	
1.8 TSI	CJSA;CJSC		02/15-	6SES14C	R134a; R1234yf	DCP32080	
2.0 TDI	CRLB;DBG A;DDAA;DFCA;DFGA;DFHA;DSR A; DSRB		11/14-	6SES14C	R134a	DCP32060	
2.0 TDI	CRLB;DBG A;DDAA;DFCA;DFGA;DFHA;DSR A; DSRB		11/14-	6SES14C	R134a; R1234yf	DCP32080	
2.0 TDI 4motion	CRLB;CUAA;DDAA;DFCA;DFEA;DFGA;DFH A		08/14-	6SES14C	R134a	DCP32060	
2.0 TDI 4motion	CRLB;CUAA;DDAA;DFCA;DFEA;DFGA;DFH A		08/14-	6SES14C	R134a; R1234yf	DCP32080	
2.0 TSI	CHHB;CXDA		02/15-	6SES14C	R134a	DCP32060	
2.0 TSI	CHHB;CXDA		02/15-	6SES14C	R134a; R1234yf	DCP32080	
2.0 TSI 4motion	CHHB;CJXA		05/15-	6SES14C	R134a	DCP32060	
2.0 TSI 4motion	CHHB;CJXA		05/15-	6SES14C	R134a; R1234yf	DCP32080	
<b>PASSAT (362, 365) (10-14)</b>							
1.4 TSI	CAXA;CTHD	For cold climates	08/10-12/14	6SEU14C	R134a	DCP02030	
1.4 TSI	CAXA;CTHD	For mild climate zones; For hot climates	08/10-12/14	7SEU17C	R134a	DCP32045	
1.4 TSI EcoFuel	CDGA	For cold climates;For mild climate zones	08/10-12/14	6SEU14C	R134a	DCP02030	
1.4 TSI EcoFuel	CDGA	For hot climate zones	08/10-12/14	7SEU17C	R134a	DCP32045	





				TYPE	GAS	DENSO PN	OE
<b>VW</b> <i>Continued</i>							
<b>PASSAT (362, 365) (10-14)</b> <i>Continued</i>							
1.4 TSI MultiFuel	CKMA			11/10-12/14	6SEU14C	R134a	DCP02030
1.4 TSI MultiFuel	CKMA			11/10-12/14	7SEU17C	R134a	DCP32045
1.6 TDI	CAYC	For cold climates		08/10-12/14	6SEU14C	R134a	DCP02050
1.6 TDI	CAYC	For mild climate zones; For hot climates		08/10-12/14	7SEU17C	R134a	DCP32045
1.8 TSI	CDAА;CDAB	For cold climates		08/10-12/14	6SEU14C	R134a	DCP02050
1.8 TSI	CDAА;CDAB	For mild climate zones; For hot climates		08/10-12/14	7SEU17C	R134a	DCP32045
1.8 TSI	CDAB			02/11-12/14	7SEU17C	R134a	DCP32045
2.0 TDI	CFFA;CFFB;CFGB;CFGC;CLLA	For cold climates		08/10-12/14	6SEU14C	R134a	DCP02050
2.0 TDI	CFFA;CFFB;CFGB;CFGC;CLLA	For mild climate zones; For hot climates		08/10-12/14	7SEU17C	R134a	DCP32045
2.0 TDI 4motion	CFFB;CFGB;CFGC	For cold climates		08/10-12/14	6SEU14C	R134a	DCP02050
2.0 TDI 4motion	CFFB;CFGB;CFGC	For mild climate zones; For hot climates		08/10-12/14	7SEU17C	R134a	DCP32045
2.0 TSI	CCZB	For cold climates		11/10-12/15	6SEU14C	R134a	DCP02050
2.0 TSI	CCZB	For cold climates;For mild climate zones		11/10-12/14	6SEU14C	R134a	DCP02050
2.0 TSI	CCZB	For hot climate zones		11/10-12/14	7SEU17C	R134a	DCP32045
2.0 TSI	CCZB	For mild climate zones; For hot climates		11/10-12/15	7SEU17C	R134a	DCP32045
2.0 TSI 4motion	CCZB	For cold climates;For mild climate zones		01/12-12/14	6SEU14C	R134a	DCP02050
2.0 TSI 4motion	CCZB	For hot climate zones		01/12-12/14	7SEU17C	R134a	DCP32045
3.6 FSI 4motion	BWS	For hot climate zones		01/11-12/14	7SEU17C	R134a	DCP32045
<b>PASSAT CC (357) (08-12)</b>							
1.4 TSI MultiFuel	CKMA	For cold climates		01/11-01/12	6SEU14C	R134a	DCP02050
1.4 TSI MultiFuel	CKMA	For mild climate zones; For hot climates		01/11-01/12	7SEU17C	R134a	DCP32045
1.8 TSI	BZB;CDAА;CDAB;CGYA	For cold climates		06/08-01/12	6SEU14C	R134a	DCP02050
1.8 TSI	BZB;CDAА;CDAB;CGYA	For mild climate zones; For hot climates		06/08-01/12	7SEU17C	R134a	DCP32045
2.0 BlueTDI	CBAC	For cold climates		05/09-11/10	6SEU14C	R134a	DCP02050
2.0 BlueTDI	CBAC	For mild climate zones; For hot climates		05/09-11/10	7SEU17C	R134a	DCP32045
2.0 TDI	CBAA;CBAB;CBBA;CBBB;CFFA;CFFB;CFG B; CLLA	For cold climates		05/08-01/12	6SEU14C	R134a	DCP02050
2.0 TDI	CBAA;CBAB;CBBA;CBBB;CFFA;CFFB;CFG B; CLLA	For mild climate zones; For hot climates		05/08-01/12	7SEU17C	R134a	DCP32045
2.0 TDI 4motion	CBAB;CBBB;CFFB;CFGB	For cold climates		08/09-01/12	6SEU14C	R134a	DCP02050
2.0 TDI 4motion	CBAB;CBBB;CFFB;CFGB	For mild climate zones; For hot climates		08/09-01/12	7SEU17C	R134a	DCP32045
2.0 TSI	CAWB;CBFA;CCTA;CCZA;CCZB	For cold climates		06/08-01/12	6SEU14C	R134a	DCP02050
2.0 TSI	CAWB;CBFA;CCTA;CCZA;CCZB	For mild climate zones; For hot climates		06/08-01/12	7SEU17C	R134a	DCP32045





				TYPE	GAS	DENSO PN	OE
<b>VW Continued</b>							
<b>PASSAT CC (357) (08-12) Continued</b>							
3.6 FSI 4motion	BLV; CNNA		06/08-01/12	7SEU17C	R134a	DCP32045	
3.6 FSI 4motion	BWS		02/08-12/11	7SEU17C	R134a	DCP32045	
<b>PHAETON (3D) (02-16)</b>							
3.0 V6 TDI 4motion	BMK;CARA;CARB;CEXA;CEXB		09/04-03/16	7SEU17C	R134a	DCP32021	
3.2 V6	AYT; BKL		04/02-05/05	7SEU16C	R134a	DCP32052	
3.2 V6 4motion	BKL; BRK		02/04-05/07	7SEU16C	R134a	DCP32052	
3.6 V6 4motion	CHNA; CMVA		11/08-03/16	7SEU17C	R134a	DCP32021	
4.2 V8 4motion	BGH; BGJ		05/03-05/07	7SEU16C	R134a	DCP02009	4E0260805F
5.0 V10 TDI 4motion	AJS	With freewheel pulley & rubber coupling kit	11/02-05/06	7SEU17C	R134a	DCP32006K	
5.0 V10 TDI 4motion	AJS	Without freewheel pulley & rubber coupling kit	11/02-05/06	7SEU17C	R134a	DCP32006	
6.0 W12 4motion	BAN; BAP		04/02-12/05	7SEU16C	R134a	DCP32052	3B0820803C
6.0 W12 4motion	BRN; BTT		05/05-03/16	7SEU17C	R134a	DCP32021	3D0820803M
<b>POLO (6R, 6C) (09-)</b>							
1.0	CHYA;CHYB		01/14-	6SES14C	R134a	DCP32060	
1.0 TSI	CHZB;CHZC		11/14-	6SES14C	R134a	DCP32060	
1.2	CGPA;CGPB		06/09-	6SEU14C	R134a	DCP32005	
1.2 TDI	CFWA		10/09-	6SEU14C	R134a	DCP02050	
1.2 TSI	CBZB;CBZC		11/09-	6SEU14C	R134a	DCP02050	
1.2 TSI 16V	CJZC;CJZD		01/14-	6SES14C	R134a	DCP32060	
1.4	CDDA; CGGB; CLPA		03/09-05/14	6SEU14C	R134a	DCP02030	
1.4 BiFuel	CMAA		03/10-01/11	6SEU14C	R134a	DCP02030	
1.4 GTI	CAVE		05/10-	6SEU14C	R134a	DCP02030	
1.4 TDI	CUSA;CUSB;CUTA;CYZA;CYZB		02/14-	6SES14C	R134a	DCP32060	
1.4 TSI	CPTA		10/12-	6SEU14C	R134a	DCP02050	
1.4 TSI	CZEA		05/14-	6SES14C	R134a	DCP32060	
1.6	CFNA; CLSA		01/10-	6SEU14C	R134a	DCP32020	
1.6	CFNA;CFNB;CLSA		05/10-	7SEU17C	R134a	DCP32045	
1.6	CWWA;CWVB		07/14-	6SES14C	R134a	DCP32060	
1.6 BiFuel	CNKA		01/11-	7SEU17C	R134a	DCP32045	
1.6 TDI	CAYA;CAYB;CAYC;CLNA		06/09-	6SEU14C	R134a	DCP02050	
1.8 GTI	DAJA; DAJB		11/14-	6SES14C	R134a	DCP32060	
2.0 R WRC	CDLJ		08/13-05/14	6SEU14C	R134a	DCP02030	
<b>POLO (9N) (01-09)</b>							
1.2	AWY; BMD		01/02-05/07	6SEU12C	R134a	DCP27002	6Q0820803G
1.2	AWY; BMD		01/02-05/07	6SEU14C	R134a	DCP32020	6Q0820803J
1.2	AWY;BBM;BMD		01/02-04/09	6SEU14C	R134a	DCP32005	6Q0820803K
1.2 12V	AZQ; BME		10/01-07/07	6SEU12C	R134a	DCP27002	6Q0820803G
1.2 12V	AZQ; BME		10/01-07/07	6SEU14C	R134a	DCP32020	6Q0820803J
1.2 12V	AZQ;BME;BZG		10/01-04/09	6SEU14C	R134a	DCP32005	6Q0820803K
1.4 16V	AUA;AUB;BBY;BBZ;BKY		10/01-07/07	6SEU12C	R134a	DCP27001	6Q0820803D
1.4 16V	BBZ;BKY		04/05-05/05	6SEU12C	R134a	DCP27002	6Q0820803G
1.4 16V	BBZ;BKY		04/05-05/05	6SEU14C	R134a	DCP32005	6Q0820803K
1.4 16V	BBZ;BKY;BUD		04/05-11/09	6SEU14C	R134a	DCP32020	6Q0820803J
1.4 FSI	AXU		02/02-05/05	6SEU12C	R134a	DCP27001	6Q0820803D
1.4 FSI	AXU		04/05-05/05	6SEU12C	R134a	DCP27002	6Q0820803G
1.4 FSI	AXU		04/05-07/06	6SEU14C	R134a	DCP32005	6Q0820803K
1.4 FSI	AXU		04/05-07/06	6SEU14C	R134a	DCP32020	6Q0820803J
1.4 TDI	AMF;BAY;BNM;BNV;BWB		10/01-06/05	6SEU12C	R134a	DCP27001	
1.4 TDI	BMS;BNM;BNV;BWB		04/05-11/09	6SEU12C	R134a	DCP27002	6Q0820803G
1.4 TDI	BMS;BNM;BNV;BWB		04/05-11/09	6SEU14C	R134a	DCP32005	6Q0820803K
1.4 TDI	BMS;BNM;BNV;BWB		04/05-11/09	6SEU14C	R134a	DCP32020	6Q0820803J
1.6 16V	BTS		05/06-11/09	6SEU14C	R134a	DCP32020	
1.8 GTI	BJX		09/05-11/09	6SEU12C	R134a	DCP27001	6Q0820803D
1.8 GTI	BJX		09/05-11/09	6SEU14C	R134a	DCP32020	6Q0820803J
1.8 GTi Cup Edition	BBU		05/06-11/09	6SEU14C	R134a	DCP32020	
1.9 SDI	ASY		10/01-05/05	6SEU12C	R134a	DCP27001	6Q0820803D
1.9 SDI	ASY		04/05-05/05	6SEU12C	R134a	DCP27002	6Q0820803G
1.9 SDI	ASY		04/05-05/05	6SEU14C	R134a	DCP32005	6Q0820803K
1.9 SDI	ASY		04/05-05/05	6SEU14C	R134a	DCP32020	6Q0820803J
1.9 TDI	ASZ;ATD;AXR;BLT		10/01-05/05	6SEU12C	R134a	DCP27001	6Q0820803D
1.9 TDI	ASZ;ATD;AXR;BLT		04/05-05/05	6SEU12C	R134a	DCP27002	6Q0820803G
1.9 TDI	ASZ;ATD;AXR;BLT		04/05-05/05	6SEU14C	R134a	DCP32005	6Q0820803K
1.9 TDI	ASZ;ATD;AXR;BLT;BMT		04/05-11/09	6SEU14C	R134a	DCP32020	6Q0820803J
<b>POLO (AW, BZ) (17-)</b>							
1.0	CHYB;CHYC;DFNB		06/17-	6SES14C	R134a; R1234yf	DCP32080	







				TYPE	GAS	DENSO PN	OE
<b>VW Continued</b>							
<b>POLO (AW, BZ) (17-) Continued</b>							
1.0 TGI	DBYA		09/17-	6SES14C	R134a; R1234yf	DCP32080	
1.0 TSI	CHZJ;CHZL;DKJA;DKLA;DKRF		06/17-	6SES14C	R134a; R1234yf	DCP32080	
1.6 TDI	DGTC;DGTD		11/17-	6SES14C	R134a; R1234yf	DCP32080	
2.0 GTI	CZPC; DKZC		11/17-	6SES14C	R134a; R1234yf	DCP32080	
<b>POLO Saloon (9A4) (02-)</b>							
1.4	BBY;BBZ		11/02-	6SEU12C	R134a	DCP27001	6Q0820803D
1.6	BAH		09/02-06/05	6SEU12C	R134a	DCP27001	6Q0820803D
1.9 TDi	ATD		09/02-05/05	6SEU12C	R134a	DCP27001	
<b>SCIROCCO (137, 138) (08-17)</b>							
1.4 TSI	CAVD;CAXA;CMSB;CNWA;CTHD;CTKA	For cold climates;For mild climate zones	05/08-11/17	6SEU14C	R134a	DCP02030	
1.4 TSI	CAVD;CAXA;CMSB;CNWA;CTHD;CTKA	For hot climate zones	05/08-11/17	7SEU17C	R134a	DCP32045	
1.4 TSI	CXSB; CZCA	For cold climates;For mild climate zones	11/13-11/17	6SEU14C	R134a	DCP02030	
1.4 TSI	CXSB; CZCA	For hot climate zones	11/13-11/17	7SEU17C	R134a	DCP32045	
2.0 R	CDLA;CDLC	For cold climates;For mild climate zones	11/09-11/17	6SEU14C	R134a	DCP02050	
2.0 R	CDLA;CDLC	For hot climate zones	11/09-11/17	7SEU17C	R134a	DCP32045	
2.0 R	CDLK		05/14-11/17	7SEU17C	R134a	DCP32045	
2.0 TDI	CBBB;CBDB;CFGB;CFHB;CFHC	For cold climates	08/08-11/17	6SEU14C	R134a	DCP02050	
2.0 TDI	CBBB;CBDB;CFGB;CFHB;CFHC	For mild climate zones; For hot climates	08/08-11/17	7SEU17C	R134a	DCP32045	
2.0 TDI	CFGC;CUUB;CUWA;CUXA	For cold climates;For mild climate zones	01/13-11/17	6SEU14C	R134a	DCP02050	
2.0 TDI	CFGC;CUUB;CUWA;CUXA	For hot climate zones	01/13-11/17	7SEU17C	R134a	DCP32045	
2.0 TSI	CAWB;CCZB	For cold climates;For mild climate zones	05/08-11/17	6SEU14C	R134a	DCP02050	
2.0 TSI	CAWB;CCZB	For hot climate zones	05/08-11/17	7SEU17C	R134a	DCP32045	
2.0 TSI	CULA;CULC		11/13-11/17	7SEU17C	R134a	DCP32045	
<b>SHARAN (7N) (10-)</b>							
1.4 TSI	CAVA; CNWB; CTHA		05/10-	7SEU17C	R134a	DCP32045	
1.4 TSI	CZDA; DJKA		05/15-	7SEU17C	R134a	DCP32045	
2.0 TDI	CFFA;CFFB;CFFE;CFGB;CFGC;CUVA;CUV C; CUWA;DFLA;DFLD;DFMA;DLUB		05/10-	7SEU17C	R134a	DCP32045	
2.0 TDI 4motion	CFFB;CUVC;DFLA;DLTA		05/11-	7SEU17C	R134a	DCP32045	
2.0 TDI 4motion	DFMA		05/16-08/16	6SES14C	R134a	DCP32060	
2.0 TSI	CGZA;DEDA		12/10-	7SEU17C	R134a	DCP32045	
<b>TIGUAN (5N) (07-)</b>							
1.4 TSI	CAVA;CAXA	For cold climates;For mild climate zones	05/08-05/11	6SEU14C	R134a	DCP02050	
1.4 TSI	CAVA;CAXA	For cold climates;For mild climate zones	05/11-07/18	6SEU14C	R134a	DCP02030	
1.4 TSI	CAVA;CAXA	For hot climate zones	05/08-07/18	7SEU17C	R134a	DCP32045	
1.4 TSI	CAVD; CTHD	For cold climates;For mild climate zones	05/11-07/18	6SEU14C	R134a	DCP02030	
1.4 TSI	CAVD; CTHD	For hot climate zones	05/11-07/18	7SEU17C	R134a	DCP32045	
1.4 TSI	CZDA	For cold climates;For mild climate zones	05/15-07/18	6SEU14C	R134a	DCP02030	

				TYPE	GAS	DENSO PN	OE
<b>VW Continued</b>							
<b>TIGUAN (5N) (07-) Continued</b>							
1.4 TSI	CZDA;CZDB	For hot climate zones	05/15-07/18	7SEU17C	R134a	DCP32045	
1.4 TSI	CZDB	For cold climates;For mild climate zones	05/15-07/18	6SEU14C	R134a	DCP02050	
1.4 TSI 4motion	BWK;CAVD;CTHD	For cold climates;For mild climate zones	09/07-07/18	6SEU14C	R134a	DCP02030	
1.4 TSI 4motion	BWK;CAVD;CTHD	For hot climate zones	09/07-07/18	7SEU17C	R134a	DCP32045	
2.0 TDI	CBAB;CFFB;CFFD;CUVE	For cold climates	03/08-07/18	6SEU14C	R134a	DCP02050	
2.0 TDI	CBAB;CFFB;CFFD;CUVE	For mild climate zones; For hot climates	03/08-07/18	7SEU17C	R134a	DCP32045	
2.0 TDI	CUVC	For cold climates;For mild climate zones	05/15-07/18	6SEU14C	R134a	DCP02050	
2.0 TDI	CUVC	For hot climate zones	05/15-07/18	7SEU17C	R134a	DCP32045	
2.0 TDI 4motion	CBAA;CBAB;CBBA;CBBB;CFFA;CFFB;CFG B; CFGC;CLJA	For cold climates	09/07-07/18	6SEU14C	R134a	DCP02050	
2.0 TDI 4motion	CBAA;CBAB;CBBA;CBBB;CFFA;CFFB;CFG B; CFGC;CLJA	For mild climate zones; For hot climates	09/07-07/18	7SEU17C	R134a	DCP32045	
2.0 TDI 4motion	CUVC;CUWA	For cold climates;For mild climate zones	05/15-07/18	6SEU14C	R134a	DCP02050	
2.0 TDI 4motion	CUVC;CUWA	For hot climate zones	05/15-07/18	7SEU17C	R134a	DCP32045	
2.0 TFSI 4motion	CAWA;CAWB		09/07-07/18	7SEU17C	R134a	DCP32045	
2.0 TSI 4motion	CCZB;CCZD	For cold climates;For mild climate zones	05/11-07/18	6SEU14C	R134a	DCP02050	
2.0 TSI 4motion	CCZB;CCZD	For hot climate zones	05/11-07/18	7SEU17C	R134a	DCP32045	
<b>TIGUAN (AD) (16-)</b>							
1.4 TSI	CZCA;CZDA;CZEA;DJVA		01/16-	6SES14C	R134a; R1234yf	DCP32080	
1.4 TSI 4motion	CZDA; CZEA		05/16-	6SES14C	R134a; R1234yf	DCP32080	
1.6 TDI	DGDB		05/16-	6SES14C	R134a; R1234yf	DCP32080	
2.0 TDI	CYKC;DFGA;DFGC		01/16-	6SES14C	R134a; R1234yf	DCP32080	
2.0 TDI 4motion	CUAA;DBGC;DFGA;DFHA		01/16-	6SES14C	R134a; R1234yf	DCP32080	
2.0 TSI 4motion	CHHB;CZPA		01/16-	6SES14C	R134a; R1234yf	DCP32080	
<b>TIGUAN Allspace (BW2) (17-)</b>							
1.4 TSI	CZDA; CZEA		06/17-	6SES14C	R134a; R1234yf	DCP32080	
2.0 TDI	DFGA		06/17-	6SES14C	R134a; R1234yf	DCP32080	
2.0 TDI 4motion	CUAA;DBGC;DFGA;DFHA		06/17-	6SES14C	R134a; R1234yf	DCP32080	
2.0 TSI	DGUA		04/17-	6SES14C	R134a; R1234yf	DCP32080	
2.0 TSI 4motion	CXDA;DGUA;DGVA		03/17-	6SES14C	R134a; R1234yf	DCP32080	
<b>TOUAREG (7L) (02-10)</b>							
2.5 R5 TDI	BAC;BLK;BPD;BPE	With freewheel pulley & rubber coupling kit	01/03-05/10	7SEU17C	R134a	DCP32006K	
2.5 R5 TDI	BAC;BLK;BPD;BPE	Without freewheel pulley & rubber coupling kit	01/03-05/10	7SEU17C	R134a	DCP32006	
3.0 TDI	BUN; CASB		04/06-05/10	7SEU17C	R134a	DCP32022	
3.0 V6 TDI	BKS;CASA;CASC;CATA		11/04-05/10	7SEU17C	R134a	DCP32022	
3.2 V6	AZZ;BAA;BKJ;BMV;BMX;BRJ		10/02-11/06	7SEU17C	R134a	DCP32055	7P0820803E
3.2 V6	AZZ;BAA;BKJ;BMV;BMX;BRJ	Ch No: >7L-5-060 000	10/02-11/06	7SEU16C	R134a	DCP32052	3B0820803C

				TYPE	GAS	DENSO PN	OE
<b>VW Continued</b>							
<b>TOUAREG (7L) (02-10) Continued</b>							
3.2 V6	AZZ;BAA;BKJ;BMV;BMX;BRJ	Ch No: 7L-5-060 001>	10/02-11/06	7SEU17C	R134a	DCP32031	7P0820803E
3.6 V6 FSI	BHK; BHL		10/05-05/10	7SEU17C	R134a	DCP32031	
3.6 V6 FSI	BHK; BHL		10/05-05/10	7SEU17C	R134a	DCP32055	7P0820803E
4.2 V8	AXQ; BHX		12/02-11/06	7SEU16C	R134a	DCP32023	
4.2 V8 FSI	BAR		06/06-05/10	7SEU16C	R134a	DCP32023	7L6820803A
4.2 V8 FSI	BAR		12/06-05/10	7SEU17C	R134a	DCP32051	7L6820803H
5.0 R50 TDI	CBWA	With freewheel pulley & rubber coupling kit	08/07-05/10	7SEU17C	R134a	DCP32006K	
5.0 R50 TDI	CBWA	Without freewheel pulley & rubber coupling kit	08/07-05/10	7SEU17C	R134a	DCP32006	
5.0 V10 TDI	AYH; BLE	With freewheel pulley & rubber coupling kit	10/02-05/10	7SEU17C	R134a	DCP32006K	
5.0 V10 TDI	AYH; BLE	Without freewheel pulley & rubber coupling kit	10/02-05/10	7SEU17C	R134a	DCP32006	
6.0 W12	BJN		08/04-11/05	7SEU16C	R134a	DCP32052	3B0820803C
6.0 W12	BJN		12/05-05/10	7SEU17C	R134a	DCP32031	7L6820803S
6.0 W12	BJN; CFRA		08/04-05/10	7SEU17C	R134a	DCP32055	7P0820803E
<b>TOUAREG (7P) (10-18)</b>							
3.0 V6 TDI	CASA;CASD;CATA;CJGD;CJMA;CNRB;CRC A; CRCD;CVWA;CVWA		01/10-03/18	7SEU17C	R134a	DCP32022	
3.0 V6 TSI	CJTA		08/10-03/18	7SEU17C	R134a	DCP32064	7P0820803F
3.6 V6 FSI	CGRA;CMTA		04/10-03/18	7SEU17C	R134a	DCP32031	
3.6 V6 FSI	CGRA;CMTA		04/10-03/18	7SEU17C	R134a	DCP32055	7P0820803E
4.2 V8 FSI	CGNA		01/11-12/14	6SEU14C	R134a	DCP32071	7P6820803B
4.2 V8 TDI	CKDA		01/10-05/11	7SEU17C	R134a	DCP02015	4E0260805AS
4.2 V8 TDI	CKDA		01/10-03/18	7SEU17C	R134a	DCP02064	8K0260805H
4.2 V8 TDI	CKDA		06/11-03/18	6SEU14C	R134a	DCP32071	4H0260805F
<b>TOURAN (1T1, 1T2) (03-10)</b>							
1.4 FSI	BLG; CAVB		11/06-05/09	7SEU17C	R134a	DCP32045	
1.4 TSI	BMV		02/06-12/08	7SEU17C	R134a	DCP32045	
1.4 TSI EcoFuel	CDGA		05/09-05/10	7SEU17C	R134a	DCP32045	
1.6	BGU; BSE; BSF		07/03-05/10	7SEU17C	R134a	DCP32045	
1.6 FSI	BAG; BLF; BLP		02/03-01/07	7SEU17C	R134a	DCP32045	
1.9 TDI	AVQ;BRU;BXF;BXJ		02/03-05/10	7SEU16C	R134a	DCP32003	
1.9 TDI	AVQ;BRU;BXF;BXJ	All Climate zones	02/03-05/10	7SEU17C	R134a	DCP32002	
1.9 TDI	BKC; BLS; BXE		08/03-05/10	7SEU17C	R134a	DCP32045	
2.0 EcoFuel	BSX		02/06-05/09	7SEU17C	R134a	DCP32045	
2.0 FSI	AXW; BLR; BLX; BLY; BVY; BVZ		10/03-01/07	7SEU17C	R134a	DCP32045	
2.0 TDI	AZV;BKD		02/03-05/10	7SEU16C	R134a	DCP32003	
2.0 TDI	AZV;BKD	All Climate zones	02/03-05/10	7SEU17C	R134a	DCP32002	
2.0 TDI	BMN	For cold climates	12/05-11/06	6SEU14C	R134a	DCP02030	
2.0 TDI 8V	BMM	For cold climates	12/05-05/10	6SEU14C	R134a	DCP02030	
2.0 TDI 8V	BMM	For mild climate zones; For hot climates	12/05-05/10	7SEU17C	R134a	DCP32045	
<b>TOURAN (1T3) (10-15)</b>							
1.2 TSI	CBZB		05/10-05/15	7SEU17C	R134a	DCP32045	
1.4 TSI	CAVB;CAVC;CTHC		05/10-05/15	7SEU17C	R134a	DCP32045	
1.4 TSI EcoFuel	CDGA		05/10-05/15	7SEU17C	R134a	DCP32045	
1.6 TDI	CAYB;CAYC		05/10-05/15	7SEU17C	R134a	DCP32045	
2.0 TDI	CFHC;CFHF;CFJA;CFJB;CLCA		05/10-05/15	7SEU17C	R134a	DCP32045	
<b>TOURAN (5T) (15-)</b>							
1.2 TSI 16V	CYVB		05/15-	6SES14C	R134a	DCP32060	
1.4 TSI	CZDA		05/15-	6SES14C	R134a	DCP32060	
1.6 TDI	CRKB;DGDA		05/15-	6SES14C	R134a	DCP32060	
1.8 TSI	CJSA		11/15-	6SES14C	R134a	DCP32060	
2.0 TDI	CRVA;CYKB;DFEA;DFEB;DFGA;DFGB;DFH A		05/15-	6SES14C	R134a	DCP32060	
<b>TRANSPORTER V (7H, 7E, 7J) (03-15)</b>							
2.0	AXA		11/03-08/15	6SES14C	R134a	DCP32065	7E0820803J
2.0	AXA		11/03-08/15	7SEU17C	R134a	DCP32070	7E0820803F

				TYPE	GAS	DENSO PN	OE
VW <i>Continued</i>							
TRANSPORTER V (7H, 7E, 7J) (03-15) <i>Continued</i>							
2.0 BiTDI	CFCA	Ch No: 7HZ*-000001;7 JZ*-000001>, For vehicles with A/C	01/12-08/15	6SEU14C	R134a	DCP32066	
2.0 BiTDI	CFCA	Ch No: 7HZ*-000001;7 JZ*-000001>, For vehicles with front and rear A/C	01/12-08/15	7SEU17C	R134a	DCP32070	
2.0 BiTDI	CFCA	Ch No: 7HZA-200001; 7HZ*-000001;7 JZ*-000001>, For vehicles with A/C	09/09-12/11	6SEU14C	R134a	DCP32069	
2.0 BiTDI	CFCA	Ch No: 7HZA-200001; 7HZ*-000001;7 JZ*-000001>, For vehicles with front and rear A/C	09/09-12/11	7SEU17C	R134a	DCP32050	
2.0 BiTDI 4motion	CFCA	Ch No: 7HZ*-000001;7 JZ*-000001>, For vehicles with A/C	01/12-08/15	6SEU14C	R134a	DCP32066	
2.0 BiTDI 4motion	CFCA	Ch No: 7HZ*-000001;7 JZ*-000001>, For vehicles with front and rear A/C	01/12-08/15	7SEU17C	R134a	DCP32070	
2.0 BiTDI 4motion	CFCA	Ch No: 7HZA-200001; 7HZ*-000001;7 JZ*-000001>, For vehicles with A/C	09/09-12/11	6SEU14C	R134a	DCP32069	
2.0 BiTDI 4motion	CFCA	Ch No: 7HZA-200001; 7HZ*-000001;7 JZ*-000001>, For vehicles with front and rear A/C	09/09-12/11	7SEU17C	R134a	DCP32050	
2.0 TDI	CAAA;CAAB;CAAC;CAAD;CAAE;CCHA;CCH B	Ch No: 7HZ*-000001;7 JZ*-000001>, For vehicles with A/C	01/12-08/15	6SEU14C	R134a	DCP32066	
2.0 TDI	CAAA;CAAB;CAAC;CAAD;CAAE;CCHA;CCH B	Ch No: 7HZ*-000001;7 JZ*-000001>, For vehicles with front and rear A/C	01/12-08/15	7SEU17C	R134a	DCP32070	
2.0 TDI	CAAA;CAAB;CAAC;CAAD;CAAE;CCHA;CCH B	Ch No: 7HZA-200001; 7HZ*-000001;7 JZ*-000001>, For vehicles with A/C	09/09-12/11	6SEU14C	R134a	DCP32069	
2.0 TDI	CAAA;CAAB;CAAC;CAAD;CAAE;CCHA;CCH B	Ch No: 7HZA-200001; 7HZ*-000001;7 JZ*-000001>, For vehicles with front and rear A/C	09/09-12/11	7SEU17C	R134a	DCP32050	
2.0 TDI 4motion	CAAC;CAAE;CCHA;CCHB	Ch No: 7HZ*-000001;7 JZ*-000001>, For vehicles with A/C	01/12-08/15	6SEU14C	R134a	DCP32066	
2.0 TDI 4motion	CAAC;CAAE;CCHA;CCHB	Ch No: 7HZ*-000001;7 JZ*-000001>, For vehicles with front and rear A/C	01/12-08/15	7SEU17C	R134a	DCP32070	
2.0 TDI 4motion	CAAC;CAAE;CCHA;CCHB	Ch No: 7HZA-200001; 7HZ*-000001;7 JZ*-000001>, For vehicles with A/C	09/09-12/11	6SEU14C	R134a	DCP32069	

				TYPE	GAS	DENSO PN	OE
<b>VW Continued</b>							
<b>TRANSPORTER V (7H, 7E, 7J) (03-15) Continued</b>							
2.0 TDI 4motion	CAAC;CAAE;CCHA;CCHB	Ch No: 7HZ*-200001; 7HZ*-000001;7 JZ*-000001>. For vehicles with front and rear A/C	09/09-12/11	7SEU17C	R134a	DCP32050	
2.0 TSI	CJKA;CJKB	For vehicles with A/C	01/12-08/15	6SES14C	R134a	DCP32065	
2.0 TSI	CJKA;CJKB	For vehicles with front and rear A/C	01/12-08/15	7SEU17C	R134a	DCP32072	
2.0 TSI 4motion	CJKA	For vehicles with A/C	01/12-08/15	6SES14C	R134a	DCP32065	
2.0 TSI 4motion	CJKA	For vehicles with front and rear A/C	01/12-08/15	7SEU17C	R134a	DCP32072	
2.5 TDI	AXD;AXE;BLJ;BNZ;BPC	With freewheel pulley & rubber coupling kit	04/03-11/09	7SEU17C	R134a	DCP32006K	
2.5 TDI	AXD;AXE;BLJ;BNZ;BPC	Without freewheel pulley & rubber coupling kit	04/03-11/09	7SEU17C	R134a	DCP32006	
2.5 TDI 4motion	AXD;AXE;BNZ;BPC	With freewheel pulley & rubber coupling kit	04/04-11/09	7SEU17C	R134a	DCP32006K	
2.5 TDI 4motion	AXD;AXE;BNZ;BPC	Without freewheel pulley & rubber coupling kit	04/04-11/09	7SEU17C	R134a	DCP32006	
<b>TRANSPORTER VI (SF, SG) (15-)</b>							
2.0 TDI	CAAA;CAAB;CAAC;CFCA;CXEB;CXFA;CXG A; CXGB;CXHA		04/15-	7SEU17C	R134a	DCP32073	
2.0 TDI	CAAA;CAAB;CAAC;CFCA;CXEB;CXFA;CXG A; CXGB;CXHA;CXHB		04/15-	6SEU14C	R134a	DCP32077	7E0820803P
2.0 TDI	CXHB		05/16-	6SES14C	R134a	DCP32060	5Q0820803F
2.0 TDI 4motion	CAAC;CFCA;CXEB;CXFA;CXHA		06/15-	7SEU17C	R134a	DCP32073	
2.0 TDI 4motion	CAAC;CFCA;CXEB;CXFA;CXHA		06/15-	6SEU14C	R134a	DCP32077	7E0820803P
2.0 TSI	CJKA;CJKB		04/15-	7SEU17C	R134a; R1234yf	DCP32076	7E0820803Q; 7E0816803D
2.0 TSI	CJKA;CJKB	For vehicles with air conditioning front and rear	04/15-	7SEU17C	R134a; R1234yf	DCP32075	7E0820803R; 7E0816803C
2.0 TSI 4motion	CJKA		06/15-	7SEU17C	R134a; R1234yf	DCP32076	7E0820803Q; 7E0816803D
2.0 TSI 4motion	CJKA	For vehicles with air conditioning front and rear	06/15-	7SEU17C	R134a; R1234yf	DCP32075	7E0820803R; 7E0816803C
<b>T-ROC (A11) (17-)</b>							
1.0 TSI	CHZJ; DKRF		07/17-	6SES14C	R134a; R1234yf	DCP32080	
1.5 TSI	DADA; DPCA		11/17-	6SES14C	R134a; R1234yf	DCP32080	
2.0 TDI 4motion	DFFA		09/17-	6SES14C	R134a; R1234yf	DCP32080	
2.0 TSI 4motion	CZPB		07/17-	6SES14C	R134a; R1234yf	DCP32080	



# DENSO Photo Guide – Compressors

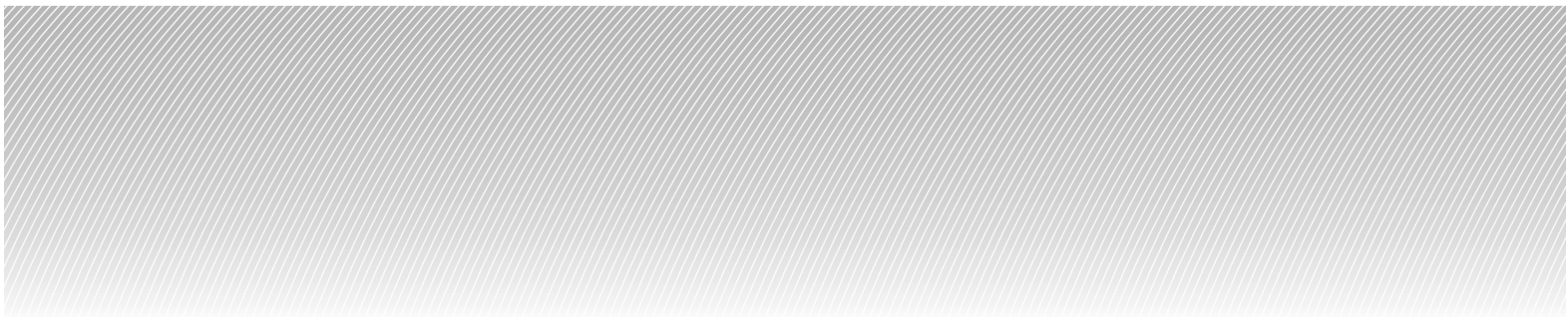

# A/C Components | Photo Guide - Compressors

FIAT-GROUP		DCP09K22	
Compressor Type	-	Clutch Type	
Refrigerant Type	R134a	Voltage	
Oil Type	ND-oil 8	Pulley Type	
Oil Quantity		Diameter	



MERCEDES-BENZ		DCP17C33	
Compressor Type	-	Clutch Type	
Refrigerant Type	R134a	Voltage	
Oil Type	ND-oil 8	Pulley Type	
Oil Quantity		Diameter	



MERCEDES-BENZ		DCP17B29	
Compressor Type	BODY 7SBU	Clutch Type	
Refrigerant Type	R134a	Voltage	
Oil Type	ND-oil 8	Pulley Type	
Oil Quantity	175	Diameter	



MERCEDES-BENZ		DCP17C36	
Compressor Type	-	Clutch Type	
Refrigerant Type	R134a	Voltage	
Oil Type	ND-oil 8	Pulley Type	
Oil Quantity		Diameter	



MERCEDES-BENZ		DCP17B35	
Compressor Type	BODY 7SBU	Clutch Type	
Refrigerant Type	R134a	Voltage	
Oil Type	ND-oil 8	Pulley Type	
Oil Quantity	175	Diameter	



CLAAS		DCP17K37	
Compressor Type	7SBU16C	Clutch Type	L50S
Refrigerant Type	R134a	Voltage	12
Oil Type	ND-oil 8	Pulley Type	Magnetic Clutch
Oil Quantity	245	Diameter	130





# A/C Components | Photo Guide - Compressors

FENDT		DCP99B03	
Compressor Type	10PA	Clutch Type	
Refrigerant Type	R134a	Voltage	
Oil Type	ND-oil 8	Pulley Type	DL-Pulley
Oil Quantity		Diameter	



FIAT-GROUP		DCP01004	
Compressor Type	TV14SC	Clutch Type	L50
Refrigerant Type	R134a	Voltage	12
Oil Type	ND-oil 9	Pulley Type	Magnetic Clutch
Oil Quantity	150	Diameter	130



-		DCP99C00	
Compressor Type	-	Clutch Type	
Refrigerant Type	R134a	Voltage	
Oil Type	ND-oil 8	Pulley Type	DL-Pulley
Oil Quantity		Diameter	



FIAT-GROUP		DCP01015	
Compressor Type	5SL12C	Clutch Type	LC35
Refrigerant Type	R134a	Voltage	12
Oil Type	ND-oil 8	Pulley Type	Magnetic Clutch
Oil Quantity	80	Diameter	130



FIAT-GROUP		DCP01001	
Compressor Type	7SBU16C	Clutch Type	L50S
Refrigerant Type	R134a	Voltage	12
Oil Type	ND-oil 8	Pulley Type	Magnetic Clutch
Oil Quantity	140	Diameter	130



VW-Group		DCP02001	
Compressor Type	10P17C	Clutch Type	
Refrigerant Type	R12 (Retrof)	Voltage	12
Oil Type	ND-oil 6	Pulley Type	Magnetic Clutch
Oil Quantity	100	Diameter	130



# A/C Components | Photo Guide - Compressors

VW-Group		DCP02002	
Compressor Type	10P17C	Clutch Type	
Refrigerant Type	R12 (Retrof)	Voltage	12
Oil Type	ND-oil 6	Pulley Type	Magnetic Clutch
Oil Quantity	100	Diameter	130



VW-Group		DCP02005	
Compressor Type	7SBU16C	Clutch Type	L50S
Refrigerant Type	R134a	Voltage	12
Oil Type	ND-oil 8	Pulley Type	Magnetic Clutch
Oil Quantity	245	Diameter	120



VW-Group		DCP02003	
Compressor Type	10P17C	Clutch Type	
Refrigerant Type	R12 (Retrof)	Voltage	12
Oil Type	ND-oil 6	Pulley Type	Magnetic Clutch
Oil Quantity	100	Diameter	120



VW-Group		DCP02006	
Compressor Type	7SBU16C	Clutch Type	L50S
Refrigerant Type	R134a	Voltage	12
Oil Type	ND-oil 8	Pulley Type	Magnetic Clutch
Oil Quantity	245	Diameter	120



VW-Group		DCP02004	
Compressor Type	7SBU16C	Clutch Type	L50S
Refrigerant Type	R134a	Voltage	12
Oil Type	ND-oil 8	Pulley Type	Magnetic Clutch
Oil Quantity	245	Diameter	120



VW-Group		DCP02007	
Compressor Type	6SEU12C	Clutch Type	DL / R-SC
Refrigerant Type	R134a	Voltage	
Oil Type	ND-oil 8	Pulley Type	DL-Pulley
Oil Quantity	180	Diameter	110



# A/C Components

## Photo Guide - Compressors

VW-Group		DCP02008	
Compressor Type	6SEU12C	Clutch Type	DL / R-SC
Refrigerant Type	R134a	Voltage	
Oil Type	ND-oil 8	Pulley Type	DL-Pulley
Oil Quantity	180	Diameter	110



VW-Group		DCP02011	
Compressor Type	7SEU16C	Clutch Type	DL / R-SC
Refrigerant Type	R134a	Voltage	
Oil Type	ND-oil 8	Pulley Type	DL-Pulley
Oil Quantity	245	Diameter	110



VW-Group		DCP02009	
Compressor Type	7SEU16C	Clutch Type	DL / R-SC
Refrigerant Type	R134a	Voltage	
Oil Type	ND-oil 8	Pulley Type	DL-Pulley
Oil Quantity	200	Diameter	115



VW-Group		DCP02012	
Compressor Type	6SEU12C	Clutch Type	DL / R-SC
Refrigerant Type	R134a	Voltage	
Oil Type	ND-oil 8	Pulley Type	DL-Pulley
Oil Quantity	180	Diameter	110



VW-Group		DCP02010	
Compressor Type	7SEU16C	Clutch Type	DL / R-SC
Refrigerant Type	R134a	Voltage	
Oil Type	ND-oil 8	Pulley Type	DL-Pulley
Oil Quantity	180	Diameter	110



VW-Group		DCP02013	
Compressor Type	6SEU12C	Clutch Type	DL / R-SC
Refrigerant Type	R134a	Voltage	
Oil Type	ND-oil 8	Pulley Type	DL-Pulley
Oil Quantity	245	Diameter	110



VW-Group		DCP02014	
Compressor Type	6SEU14C	Clutch Type	DL / B-PC
Refrigerant Type	R134a	Voltage	
Oil Type	ND-oil 8	Pulley Type	DL-Pulley
Oil Quantity	130	Diameter	100



VW-Group		DCP02022	
Compressor Type	7SEU16C	Clutch Type	DL / R-SC
Refrigerant Type	R134a	Voltage	
Oil Type	ND-oil 8	Pulley Type	DL-Pulley
Oil Quantity	200	Diameter	110



VW-Group		DCP02015	
Compressor Type	7SEU17C	Clutch Type	Direct-Drive
Refrigerant Type	R134a	Voltage	
Oil Type	ND-oil 8	Pulley Type	DL-Pulley
Oil Quantity	130	Diameter	



VW-Group		DCP02023	
Compressor Type	6SEU12C	Clutch Type	DL / R-SC
Refrigerant Type	R134a	Voltage	
Oil Type	ND-oil 8	Pulley Type	DL-Pulley
Oil Quantity	180	Diameter	110



VW-Group		DCP02016	
Compressor Type	6SEU14C	Clutch Type	DL / B-PC
Refrigerant Type	R134a	Voltage	
Oil Type	ND-oil 8	Pulley Type	DL-Pulley
Oil Quantity	130	Diameter	115

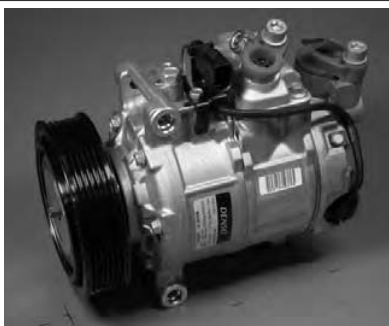

VW-Group		DCP02024	
Compressor Type	6SEU12C	Clutch Type	DL / R-SC
Refrigerant Type	R134a	Voltage	
Oil Type	ND-oil 8	Pulley Type	DL-Pulley
Oil Quantity	180	Diameter	110



VW-Group		DCP02025	
Compressor Type	7SEU16C	Clutch Type	DL / R-SC
Refrigerant Type	R134a	Voltage	
Oil Type	ND-oil 8	Pulley Type	DL-Pulley
Oil Quantity	180	Diameter	110



VW-Group		DCP02028	
Compressor Type	6SEU14C	Clutch Type	DL / B-PC
Refrigerant Type	R134a	Voltage	
Oil Type	ND-oil 8	Pulley Type	DL-Pulley
Oil Quantity	120	Diameter	100



VW-Group		DCP02026	
Compressor Type	7SEU16C	Clutch Type	DL / R-SC
Refrigerant Type	R134a	Voltage	
Oil Type	ND-oil 8	Pulley Type	DL-Pulley
Oil Quantity	180	Diameter	110



VW-Group		DCP02030	
Compressor Type	6SEU14C	Clutch Type	DL / B-PC
Refrigerant Type	R134a	Voltage	
Oil Type	ND-oil 8	Pulley Type	DL-Pulley
Oil Quantity	85	Diameter	110



VW-Group		DCP02027	
Compressor Type	7SEU17C	Clutch Type	DL / B-PC
Refrigerant Type	R134a	Voltage	
Oil Type	ND-oil 8	Pulley Type	DL-Pulley
Oil Quantity	120	Diameter	110



VW-Group		DCP02031	
Compressor Type	7SEU17C	Clutch Type	DL / B-PC
Refrigerant Type	R134a	Voltage	
Oil Type	ND-oil 8	Pulley Type	DL-Pulley
Oil Quantity	150	Diameter	125



VW-Group		DCP02032	
Compressor Type	7SEU17C	Clutch Type	DL / B-PC
Refrigerant Type	R134a	Voltage	
Oil Type	ND-oil 8	Pulley Type	DL-Pulley
Oil Quantity	150	Diameter	115



VW-Group		DCP02035	
Compressor Type	6SEU14C	Clutch Type	DL / B-PC
Refrigerant Type	R134a	Voltage	
Oil Type	ND-oil 8	Pulley Type	DL-Pulley
Oil Quantity	150	Diameter	100



VW-Group		DCP02033	
Compressor Type	7SEU17C	Clutch Type	DL / B-PC
Refrigerant Type	R134a	Voltage	
Oil Type	ND-oil 8	Pulley Type	DL-Pulley
Oil Quantity	120	Diameter	125



VW-Group		DCP02036	
Compressor Type	6SEU14C	Clutch Type	DL / B-PC
Refrigerant Type	R134a	Voltage	
Oil Type	ND-oil 8	Pulley Type	DL-Pulley
Oil Quantity	130	Diameter	125



VW-Group		DCP02034	
Compressor Type	7SEU17C	Clutch Type	DL / B-PC
Refrigerant Type	R134a	Voltage	
Oil Type	ND-oil 8	Pulley Type	DL-Pulley
Oil Quantity	120	Diameter	115



VW-Group		DCP02037	
Compressor Type	6SEU14C	Clutch Type	DL / B-PC
Refrigerant Type	R134a	Voltage	
Oil Type	ND-oil 8	Pulley Type	DL-Pulley
Oil Quantity	130	Diameter	100



VW-Group		DCP02038	
Compressor Type	6SEU14C	Clutch Type	DL / B-PC
Refrigerant Type	R134a	Voltage	
Oil Type	ND-oil 8	Pulley Type	DL-Pulley
Oil Quantity	120	Diameter	100



VW-Group		DCP02041	
Compressor Type	6SEU14C	Clutch Type	DL / B-PC
Refrigerant Type	R134a	Voltage	
Oil Type	ND-oil 8	Pulley Type	DL-Pulley
Oil Quantity	120	Diameter	100



VW-Group		DCP02039	
Compressor Type	6SEU14C	Clutch Type	DL / B-PC
Refrigerant Type	R134a	Voltage	
Oil Type	ND-oil 8	Pulley Type	DL-Pulley
Oil Quantity	120	Diameter	110



VW-Group		DCP02042	
Compressor Type	6SEU14C	Clutch Type	DL / A1-PD
Refrigerant Type	R134a	Voltage	
Oil Type	ND-oil 8	Pulley Type	DL-Pulley
Oil Quantity	150	Diameter	100



VW-Group		DCP02040	
Compressor Type	6SEU14C	Clutch Type	DL / B-PC
Refrigerant Type	R134a	Voltage	
Oil Type	ND-oil 8	Pulley Type	DL-Pulley
Oil Quantity	130	Diameter	100



VW-Group		DCP02043	
Compressor Type	6SEU14C	Clutch Type	DL / B-PC
Refrigerant Type	R134a	Voltage	
Oil Type	ND-oil 8	Pulley Type	DL-Pulley
Oil Quantity	150	Diameter	125



# A/C Components | Photo Guide - Compressors

VW-Group		DCP02044	
Compressor Type	6SEU14C	Clutch Type	DL / A0-PD
Refrigerant Type	R134a	Voltage	
Oil Type	ND-oil 8	Pulley Type	DL-Pulley
Oil Quantity	150	Diameter	100



VW-Group		DCP02047	
Compressor Type	7SBU16C	Clutch Type	L50S
Refrigerant Type	R134a	Voltage	12
Oil Type	ND-oil 8	Pulley Type	Magnetic Clutch
Oil Quantity	245	Diameter	120



VW-Group		DCP02045	
Compressor Type	7SEU14C	Clutch Type	DL / R-SC
Refrigerant Type	R134a	Voltage	
Oil Type	ND-oil 8	Pulley Type	DL-Pulley
Oil Quantity	180	Diameter	110



VW-Group		DCP02048	
Compressor Type	6SEU12C	Clutch Type	DL / R-SC
Refrigerant Type	R134a	Voltage	
Oil Type	ND-oil 8	Pulley Type	DL-Pulley
Oil Quantity	180	Diameter	110



VW-Group		DCP02046	
Compressor Type	7SEU16C	Clutch Type	DL / R-SC
Refrigerant Type	R134a	Voltage	
Oil Type	ND-oil 8	Pulley Type	DL-Pulley
Oil Quantity	220	Diameter	110



VW-Group		DCP02050	
Compressor Type	6SEU14C	Clutch Type	DL / B-PC
Refrigerant Type	R134a	Voltage	
Oil Type	ND-oil 8	Pulley Type	DL-Pulley
Oil Quantity	95	Diameter	110





VW-Group		DCP02052	
Compressor Type	6SEU14C	Clutch Type	DL / B-PC
Refrigerant Type	R134a	Voltage	
Oil Type	ND-oil 8	Pulley Type	DL-Pulley
Oil Quantity	120	Diameter	100



VW-Group		DCP02061	
Compressor Type	6SEU12C	Clutch Type	
Refrigerant Type	R134a	Voltage	
Oil Type	ND-oil 8	Pulley Type	DL-Pulley
Oil Quantity	180	Diameter	110



VW-Group		DCP02055	
Compressor Type	7SEU17C	Clutch Type	Shaft Drive
Refrigerant Type	R134a	Voltage	
Oil Type	ND-oil 8	Pulley Type	DL-Pulley
Oil Quantity	220	Diameter	



VW-Group		DCP02063	
Compressor Type	6SEU14C	Clutch Type	DL
Refrigerant Type	R134a	Voltage	
Oil Type	ND-oil 8	Pulley Type	DL-Pulley
Oil Quantity	150	Diameter	100



VW-Group		DCP02060	
Compressor Type	6SEU14C	Clutch Type	
Refrigerant Type	R134a	Voltage	
Oil Type	ND-oil 8	Pulley Type	DL-Pulley
Oil Quantity	150	Diameter	100



VW-Group		DCP02064	
Compressor Type	7SEU17C	Clutch Type	DL
Refrigerant Type	R134a	Voltage	
Oil Type	ND-oil 8	Pulley Type	DL-Pulley
Oil Quantity	150	Diameter	



# A/C Components | Photo Guide - Compressors

VW-Group		DCP02065	
Compressor Type	6SEU14C	Clutch Type	DL / B-PC
Refrigerant Type	R134a	Voltage	
Oil Type	ND-oil 8	Pulley Type	DL-Pulley
Oil Quantity	120	Diameter	100



VW-Group		DCP02092	
Compressor Type	6SEU14C	Clutch Type	
Refrigerant Type	R134a	Voltage	
Oil Type	ND-oil 8	Pulley Type	DL-Pulley
Oil Quantity	150	Diameter	110



VW-Group		DCP02090	
Compressor Type	6SEU14C	Clutch Type	DL / B-PC
Refrigerant Type	R134a	Voltage	
Oil Type	ND-oil 8	Pulley Type	DL-Pulley
Oil Quantity	130	Diameter	110



VW-Group		DCP02095	
Compressor Type	6SEU14C	Clutch Type	
Refrigerant Type	R134a	Voltage	
Oil Type	ND-oil 8	Pulley Type	DL-Pulley
Oil Quantity	130	Diameter	110



VW-Group		DCP02091	
Compressor Type	7SEU16C	Clutch Type	DL / R-SC
Refrigerant Type	R134a	Voltage	
Oil Type	ND-oil 8	Pulley Type	DL-Pulley
Oil Quantity	200	Diameter	110



VW-Group		DCP02096	
Compressor Type	7SEU17C	Clutch Type	
Refrigerant Type	R134a	Voltage	
Oil Type	ND-oil 8	Pulley Type	DL-Pulley
Oil Quantity	140	Diameter	110



# A/C Components | Photo Guide - Compressors

VW-Group		DCP02097	
Compressor Type	6SEU14C	Clutch Type	
Refrigerant Type	R134a	Voltage	
Oil Type	ND-oil 8	Pulley Type	DL-Pulley
Oil Quantity	110	Diameter	110



VW-Group		DCP02101	
Compressor Type	6SBU14C	Clutch Type	
Refrigerant Type	R134a	Voltage	12
Oil Type	ND-oil 8	Pulley Type	Magnetic Clutch
Oil Quantity	150	Diameter	110



VW-Group		DCP02098	
Compressor Type	6SAS14C	Clutch Type	
Refrigerant Type	R134a	Voltage	12
Oil Type	ND-oil 8	Pulley Type	Magnetic Clutch
Oil Quantity	110	Diameter	110



VW-Group		DCP02102	
Compressor Type	6SES14C	Clutch Type	
Refrigerant Type	R134a	Voltage	
Oil Type	ND-oil 8	Pulley Type	DL-Pulley
Oil Quantity	110	Diameter	110



VW-Group		DCP02099	
Compressor Type	6SEU14C	Clutch Type	
Refrigerant Type	R134a	Voltage	
Oil Type	ND-oil 8	Pulley Type	DL-Pulley
Oil Quantity	120	Diameter	110



AUDI		DCP02103	
Compressor Type	6SEU14C	Clutch Type	
Refrigerant Type	R134a	Voltage	
Oil Type	ND-Oil 8	Pulley Type	DL-Pulley
Oil Quantity	120	Diameter	125



AUDI		DCP02104	
Compressor Type	7SEU17C	Clutch Type	Direct-Drive
Refrigerant Type	R134a	Voltage	
Oil Type	ND-Oil 8	Pulley Type	DL-Pulley
Oil Quantity	200	Diameter	



VW-Group		DCP02107	
Compressor Type	6SEU14C	Clutch Type	
Refrigerant Type	R134a	Voltage	
Oil Type	ND-oil 8	Pulley Type	DL-Pulley
Oil Quantity	130	Diameter	



AUDI		DCP02105	
Compressor Type	6SES14C	Clutch Type	DL
Refrigerant Type	R134a	Voltage	
Oil Type	ND-Oil 8	Pulley Type	DL-Pulley
Oil Quantity	110	Diameter	125



VW-Group		DCP02108	
Compressor Type	6SEU14C	Clutch Type	
Refrigerant Type	R134a	Voltage	
Oil Type	ND-oil 8	Pulley Type	DL-Pulley
Oil Quantity	120	Diameter	



VW-Group		DCP02106	
Compressor Type	6SES14C	Clutch Type	
Refrigerant Type	R134a; R12	Voltage	
Oil Type	ND-oil 12	Pulley Type	DL-Pulley
Oil Quantity	110	Diameter	110



VW-Group		DCP02109	
Compressor Type	6SES14C	Clutch Type	
Refrigerant Type	R134a	Voltage	
Oil Type	ND-oil 8	Pulley Type	
Oil Quantity		Diameter	



# A/C Components

## Photo Guide - Compressors

VW-Group		DCP02110	
Compressor Type	6SBU14C	Clutch Type	
Refrigerant Type	R134a	Voltage	12
Oil Type	ND-oil 8	Pulley Type	
Oil Quantity	120	Diameter	110



BMW		DCP05004	
Compressor Type	10PA17C	Clutch Type	L50
Refrigerant Type	R134a	Voltage	12
Oil Type	ND-oil 8	Pulley Type	Magnetic Clutch
Oil Quantity	170	Diameter	120



BMW		DCP05001	
Compressor Type	10PA17C	Clutch Type	L50
Refrigerant Type	R134a	Voltage	12
Oil Type	ND-oil 8	Pulley Type	Magnetic Clutch
Oil Quantity	170	Diameter	110



BMW		DCP05006	
Compressor Type	10PA17C	Clutch Type	L50
Refrigerant Type	R134a	Voltage	12
Oil Type	ND-oil 8	Pulley Type	Magnetic Clutch
Oil Quantity	190	Diameter	120



BMW		DCP05003	
Compressor Type	10PA17C	Clutch Type	L50
Refrigerant Type	R134a	Voltage	12
Oil Type	ND-oil 8	Pulley Type	Magnetic Clutch
Oil Quantity	170	Diameter	110



BMW		DCP05007	
Compressor Type	10PA17C	Clutch Type	L50
Refrigerant Type	R134a	Voltage	12
Oil Type	ND-oil 8	Pulley Type	Magnetic Clutch
Oil Quantity	130	Diameter	120



# A/C Components | Photo Guide - Compressors

BMW		DCP05008	
Compressor Type	10PA17C	Clutch Type	L50
Refrigerant Type	R134a	Voltage	12
Oil Type	ND-oil 8	Pulley Type	Magnetic Clutch
Oil Quantity	170	Diameter	110



BMW		DCP05012	
Compressor Type	10PA17C	Clutch Type	L50
Refrigerant Type	R134a	Voltage	12
Oil Type	ND-oil 8	Pulley Type	Magnetic Clutch
Oil Quantity	170	Diameter	130



BMW		DCP05009	
Compressor Type	10PA17C	Clutch Type	L50
Refrigerant Type	R134a	Voltage	12
Oil Type	ND-oil 8	Pulley Type	Magnetic Clutch
Oil Quantity	170	Diameter	110



BMW		DCP05013	
Compressor Type	7SBU16C	Clutch Type	L50S
Refrigerant Type	R134a	Voltage	12
Oil Type	ND-oil 8	Pulley Type	Magnetic Clutch
Oil Quantity	160	Diameter	120



BMW		DCP05010	
Compressor Type	10PA17C	Clutch Type	L50
Refrigerant Type	R134a	Voltage	12
Oil Type	ND-oil 8	Pulley Type	Magnetic Clutch
Oil Quantity	130	Diameter	120



BMW		DCP05014	
Compressor Type	7SBU16C	Clutch Type	L50S
Refrigerant Type	R134a	Voltage	12
Oil Type	ND-oil 8	Pulley Type	Magnetic Clutch
Oil Quantity	160	Diameter	110



# A/C Components | Photo Guide - Compressors

BMW		DCP05015	
Compressor Type	7SBU16C	Clutch Type	L50S
Refrigerant Type	R134a	Voltage	12
Oil Type	ND-oil 8	Pulley Type	Magnetic Clutch
Oil Quantity	160	Diameter	110



BMW		DCP05018	
Compressor Type	7SBU16C	Clutch Type	L50S
Refrigerant Type	R134a	Voltage	12
Oil Type	ND-oil 8	Pulley Type	Magnetic Clutch
Oil Quantity	160	Diameter	110



BMW		DCP05016	
Compressor Type	7SBU16C	Clutch Type	L50S
Refrigerant Type	R134a	Voltage	12
Oil Type	ND-oil 8	Pulley Type	Magnetic Clutch
Oil Quantity	160	Diameter	110



BMW		DCP05019	
Compressor Type	7SBU16C	Clutch Type	L50S
Refrigerant Type	R134a	Voltage	12
Oil Type	ND-oil 8	Pulley Type	Magnetic Clutch
Oil Quantity	160	Diameter	110



BMW		DCP05017	
Compressor Type	7SBU16C	Clutch Type	L50S
Refrigerant Type	R134a	Voltage	12
Oil Type	ND-oil 8	Pulley Type	Magnetic Clutch
Oil Quantity	160	Diameter	120



BMW		DCP05020	
Compressor Type	7SEU17C	Clutch Type	DL / B-SC
Refrigerant Type	R134a	Voltage	
Oil Type	ND-oil 8	Pulley Type	DL-Pulley
Oil Quantity	180	Diameter	100



# A/C Components | Photo Guide - Compressors

BMW		DCP05021	
Compressor Type	7SEU17C	Clutch Type	DL / B-PC
Refrigerant Type	R134a	Voltage	
Oil Type	ND-oil 8	Pulley Type	DL-Pulley
Oil Quantity	180	Diameter	110



BMW		DCP05031	
Compressor Type	7SBU16C	Clutch Type	L50S
Refrigerant Type	R134a	Voltage	12
Oil Type	ND-oil 8	Pulley Type	Magnetic Clutch
Oil Quantity	160	Diameter	110



BMW		DCP05022	
Compressor Type	5SA09C	Clutch Type	CL / LC35S
Refrigerant Type	R134a	Voltage	12
Oil Type	ND-oil 8	Pulley Type	Magnetic Clutch
Oil Quantity	90	Diameter	105



BMW		DCP05032	
Compressor Type	7SEU17C	Clutch Type	DL / B-SC
Refrigerant Type	R134a	Voltage	
Oil Type	ND-oil 8	Pulley Type	DL-Pulley
Oil Quantity	180	Diameter	110



BMW		DCP05026	
Compressor Type	5SE12C	Clutch Type	DL / B-PC
Refrigerant Type	R134a	Voltage	
Oil Type	ND-oil 8	Pulley Type	DL-Pulley
Oil Quantity	150	Diameter	100



BMW		DCP05033	
Compressor Type	7SEU17C	Clutch Type	DL / B-SC
Refrigerant Type	R134a	Voltage	
Oil Type	ND-oil 8	Pulley Type	DL-Pulley
Oil Quantity	180	Diameter	110





# A/C Components

## Photo Guide - Compressors

BMW		DCP05034	
Compressor Type	7SBU17C	Clutch Type	CL / LC45S
Refrigerant Type	R134a	Voltage	12
Oil Type	ND-oil 8	Pulley Type	Magnetic Clutch
Oil Quantity	180	Diameter	110



BMW		DCP05037	
Compressor Type	7SEU17C	Clutch Type	DL / B-PC
Refrigerant Type	R134a	Voltage	
Oil Type	ND-oil 8	Pulley Type	DL-Pulley
Oil Quantity	180	Diameter	100



BMW		DCP05035	
Compressor Type	7SEU17C	Clutch Type	DL / B-SC
Refrigerant Type	R134a	Voltage	
Oil Type	ND-oil 8	Pulley Type	DL-Pulley
Oil Quantity	180	Diameter	100



BMW		DCP05038	
Compressor Type	7SEU17C	Clutch Type	DL / B-SC
Refrigerant Type	R134a	Voltage	
Oil Type	ND-oil 8	Pulley Type	DL-Pulley
Oil Quantity	180	Diameter	100



BMW		DCP05036	
Compressor Type	7SEU17C	Clutch Type	DL / B-SC
Refrigerant Type	R134a	Voltage	
Oil Type	ND-oil 8	Pulley Type	DL-Pulley
Oil Quantity	180	Diameter	110



BMW		DCP05039	
Compressor Type	7SBU16C	Clutch Type	L50S
Refrigerant Type	R134a	Voltage	12
Oil Type	ND-oil 8	Pulley Type	Magnetic Clutch
Oil Quantity	160	Diameter	110



# A/C Components | Photo Guide - Compressors

BMW		DCP05040	
Compressor Type	7SBU16C	Clutch Type	L50S
Refrigerant Type	R134a	Voltage	12
Oil Type	ND-oil 8	Pulley Type	Magnetic Clutch
Oil Quantity	160	Diameter	110



BMW		DCP05046	
Compressor Type	10S17C	Clutch Type	CL / L50T
Refrigerant Type	R134a	Voltage	12
Oil Type	ND-oil 8	Pulley Type	Magnetic Clutch
Oil Quantity	110	Diameter	120



BMW		DCP05042	
Compressor Type	7SEU17C	Clutch Type	DL / B-SC
Refrigerant Type	R134a	Voltage	
Oil Type	ND-oil 8	Pulley Type	DL-Pulley
Oil Quantity	180	Diameter	110



BMW		DCP05050	
Compressor Type	6SBU14C	Clutch Type	CL / LC45S
Refrigerant Type	R134a	Voltage	12
Oil Type	ND-oil 8	Pulley Type	Magnetic Clutch
Oil Quantity	180	Diameter	110



BMW		DCP05045	
Compressor Type	7SEU17C	Clutch Type	DL / B-SC
Refrigerant Type	R134a	Voltage	
Oil Type	ND-oil 8	Pulley Type	DL-Pulley
Oil Quantity	180	Diameter	110



BMW		DCP05052	
Compressor Type	7SEU17C	Clutch Type	DL / B-SC
Refrigerant Type	R134a	Voltage	
Oil Type	ND-oil 8	Pulley Type	DL-Pulley
Oil Quantity	180	Diameter	110



# A/C Components

## Photo Guide - Compressors

BMW		DCP05060	
Compressor Type	7SEU17C	Clutch Type	B-SC
Refrigerant Type	R134a	Voltage	
Oil Type	ND-oil 8	Pulley Type	DL-Pulley
Oil Quantity	180	Diameter	110



BMW		DCP05076	
Compressor Type	7SBU17C	Clutch Type	LC45S
Refrigerant Type	R134a	Voltage	12
Oil Type	ND-oil 8	Pulley Type	Magnetic Clutch
Oil Quantity	150	Diameter	110



BMW		DCP05061	
Compressor Type	6SEU14C	Clutch Type	DL
Refrigerant Type	R134a	Voltage	
Oil Type	ND-oil 8	Pulley Type	DL-Pulley
Oil Quantity	180	Diameter	110



BMW		DCP05077	
Compressor Type	7SBU17C	Clutch Type	LC45S
Refrigerant Type	R134a	Voltage	12
Oil Type	ND-oil 8	Pulley Type	Magnetic Clutch
Oil Quantity	150	Diameter	110



BMW		DCP05062	
Compressor Type	6SEU14C	Clutch Type	B-SC
Refrigerant Type	R134a	Voltage	
Oil Type	ND-oil 8	Pulley Type	DL-Pulley
Oil Quantity	180	Diameter	110



BMW		DCP05078	
Compressor Type	7SBU17C	Clutch Type	LC45S
Refrigerant Type	R134a	Voltage	12
Oil Type	ND-oil 8	Pulley Type	Magnetic Clutch
Oil Quantity	150	Diameter	110



BMW		DCP05079	
Compressor Type	7SEU17C	Clutch Type	B-PC
Refrigerant Type	R134a	Voltage	
Oil Type	ND-oil 8	Pulley Type	DL-Pulley
Oil Quantity	180	Diameter	110



BMW		DCP05082	
Compressor Type	7SBU17C	Clutch Type	LC45S
Refrigerant Type	R134a	Voltage	12
Oil Type	ND-oil 8	Pulley Type	Magnetic Clutch
Oil Quantity	180	Diameter	110



BMW		DCP05080	
Compressor Type	7SEU17C	Clutch Type	B-PC
Refrigerant Type	R134a	Voltage	
Oil Type	ND-oil 8	Pulley Type	DL-Pulley
Oil Quantity	150	Diameter	110



BMW		DCP05083	
Compressor Type	7SBU17C	Clutch Type	LC45S
Refrigerant Type	R134a	Voltage	12
Oil Type	ND-oil 8	Pulley Type	Magnetic Clutch
Oil Quantity	180	Diameter	110



BMW		DCP05081	
Compressor Type	7SBU17C	Clutch Type	LC45S
Refrigerant Type	R134a	Voltage	12
Oil Type	ND-oil 8	Pulley Type	Magnetic Clutch
Oil Quantity	150	Diameter	110



BMW		DCP05084	
Compressor Type	7SEU17C	Clutch Type	B-SC
Refrigerant Type	R134a	Voltage	
Oil Type	ND-oil 8	Pulley Type	DL-Pulley
Oil Quantity	180	Diameter	110



# A/C Components | Photo Guide - Compressors

BMW		DCP05088	
Compressor Type	7SBU17C	Clutch Type	
Refrigerant Type	R134a	Voltage	12
Oil Type	ND-oil 8	Pulley Type	Magnetic Clutch
Oil Quantity	140	Diameter	110



BMW		DCP05091	
Compressor Type	6SEU14A	Clutch Type	
Refrigerant Type	R134a	Voltage	
Oil Type	ND-oil 8	Pulley Type	DL-Pulley
Oil Quantity	150	Diameter	110



BMW		DCP05089	
Compressor Type	7SEU17C	Clutch Type	
Refrigerant Type	R134a	Voltage	
Oil Type	ND-oil 8	Pulley Type	DL-Pulley
Oil Quantity	150	Diameter	110



BMW		DCP05092	
Compressor Type	7SEU17C	Clutch Type	
Refrigerant Type	R134a	Voltage	
Oil Type	ND-oil 8	Pulley Type	DL-Pulley
Oil Quantity	180	Diameter	100



BMW		DCP05090	
Compressor Type	7SEU17C	Clutch Type	
Refrigerant Type	R134a	Voltage	
Oil Type	ND-oil 8	Pulley Type	DL-Pulley
Oil Quantity	150	Diameter	110



BMW		DCP05093	
Compressor Type	7SBU17C	Clutch Type	
Refrigerant Type	R134a	Voltage	12
Oil Type	ND-oil 8	Pulley Type	Magnetic Clutch
Oil Quantity	120	Diameter	100



# A/C Components | Photo Guide - Compressors

BMW		DCP05094	
Compressor Type	7SEU17C	Clutch Type	
Refrigerant Type	R134a	Voltage	
Oil Type	ND-oil 8	Pulley Type	DL-Pulley
Oil Quantity	180	Diameter	110



BMW		DCP05097	
Compressor Type	7SEU17A	Clutch Type	
Refrigerant Type	R134a	Voltage	
Oil Type	ND-oil 8	Pulley Type	DL-Pulley
Oil Quantity	150	Diameter	110



BMW		DCP05095	
Compressor Type	6SBU14A	Clutch Type	
Refrigerant Type	R134a	Voltage	12
Oil Type	ND-oil 8	Pulley Type	Magnetic Clutch
Oil Quantity	150	Diameter	110



BMW		DCP05098	
Compressor Type	6SEU14C	Clutch Type	
Refrigerant Type	R134a	Voltage	
Oil Type	ND-oil 8	Pulley Type	DL-Pulley
Oil Quantity	150	Diameter	110



BMW		DCP05096	
Compressor Type	7SBU17A	Clutch Type	
Refrigerant Type	R134a	Voltage	12
Oil Type	ND-oil 8	Pulley Type	Magnetic Clutch
Oil Quantity	150	Diameter	110



BMW		DCP05099	
Compressor Type	6SEU14A	Clutch Type	
Refrigerant Type	R134a	Voltage	
Oil Type	ND-oil 8	Pulley Type	DL-Pulley
Oil Quantity	150	Diameter	110



# A/C Components

## Photo Guide - Compressors

BMW		DCP05102	
Compressor Type	7SBU17C	Clutch Type	L50S
Refrigerant Type	R134a	Voltage	12
Oil Type	ND-oil 8	Pulley Type	Magnetic Clutch
Oil Quantity		Diameter	

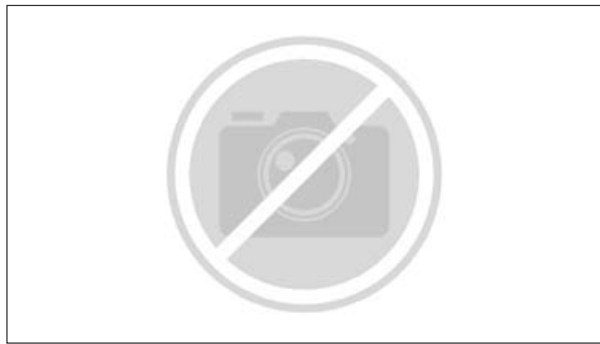

BMW		DCP05106	
Compressor Type	6SBU14A	Clutch Type	LC45S
Refrigerant Type	R134a	Voltage	12
Oil Type	ND-oil 8	Pulley Type	Magnetic Clutch
Oil Quantity	100	Diameter	110



BMW		DCP05104	
Compressor Type	6SBU14C	Clutch Type	LC45S
Refrigerant Type	R134a	Voltage	12
Oil Type	ND-oil 8	Pulley Type	Magnetic Clutch
Oil Quantity	150	Diameter	110



BMW		DCP05107	
Compressor Type	7SEU17C	Clutch Type	
Refrigerant Type	R134a	Voltage	12
Oil Type	ND-oil 8	Pulley Type	DL-Pulley
Oil Quantity	180	Diameter	110



BMW		DCP05105	
Compressor Type	6SEU14A	Clutch Type	DL
Refrigerant Type	R134a	Voltage	
Oil Type	ND-oil 8	Pulley Type	DL-Pulley
Oil Quantity	100	Diameter	110



BMW		DCP05108	
Compressor Type	6SBU14C	Clutch Type	LC45S
Refrigerant Type	R134a	Voltage	12
Oil Type	ND-oil 8	Pulley Type	Magnetic Clutch
Oil Quantity	180	Diameter	110



BMW		DCP05114	
Compressor Type	7SEU17A	Clutch Type	
Refrigerant Type	R134a	Voltage	
Oil Type	ND-oil 8	Pulley Type	DL-Pulley
Oil Quantity	100	Diameter	110



CHRYSLER		DCP06002	
Compressor Type	-	Clutch Type	
Refrigerant Type	R134a	Voltage	
Oil Type	ND-oil 8	Pulley Type	DL-Pulley
Oil Quantity		Diameter	



BMW		DCP05115	
Compressor Type	7SBU17A	Clutch Type	
Refrigerant Type	R134a	Voltage	12
Oil Type	ND-oil 8	Pulley Type	Magnetic Clutch
Oil Quantity	100	Diameter	110



CHRYSLER		DCP06003	
Compressor Type	10PA17C	Clutch Type	L50
Refrigerant Type	R134a	Voltage	12
Oil Type	ND-oil 8	Pulley Type	Magnetic Clutch
Oil Quantity	150	Diameter	135



CHRYSLER		DCP06001	
Compressor Type	-	Clutch Type	
Refrigerant Type	R134a	Voltage	
Oil Type	ND-oil 8	Pulley Type	DL-Pulley
Oil Quantity		Diameter	



CHRYSLER		DCP06005	
Compressor Type	10PA17J	Clutch Type	
Refrigerant Type	R134a	Voltage	
Oil Type	ND-oil 8	Pulley Type	DL-Pulley
Oil Quantity		Diameter	125





# A/C Components | Photo Guide - Compressors

CHRYSLER		DCP06006	
Compressor Type	10PA17J	Clutch Type	L50
Refrigerant Type	R134a	Voltage	12
Oil Type	ND-oil 8	Pulley Type	Magnetic Clutch
Oil Quantity	230	Diameter	125



CHRYSLER		DCP06016	
Compressor Type	10S20C	Clutch Type	L50T
Refrigerant Type	R134a	Voltage	12
Oil Type	ND-oil 8	Pulley Type	Magnetic Clutch
Oil Quantity	180	Diameter	120



CHRYSLER		DCP06009	
Compressor Type	10PA17C	Clutch Type	L50
Refrigerant Type	R134a	Voltage	12
Oil Type	ND-oil 8	Pulley Type	Magnetic Clutch
Oil Quantity	210	Diameter	143



CHRYSLER		DCP06017	
Compressor Type	10S20H	Clutch Type	L50T
Refrigerant Type	R134a	Voltage	12
Oil Type	ND-oil 8	Pulley Type	Magnetic Clutch
Oil Quantity	230	Diameter	130



CHRYSLER		DCP06012	
Compressor Type	10S17C	Clutch Type	CL / L50T
Refrigerant Type	R134a	Voltage	12
Oil Type	ND-oil 8	Pulley Type	Magnetic Clutch
Oil Quantity	160	Diameter	120



CHRYSLER		DCP06018	
Compressor Type	10S17C	Clutch Type	L50T
Refrigerant Type	R134a	Voltage	12
Oil Type	ND-oil 8	Pulley Type	Magnetic Clutch
Oil Quantity	160	Diameter	120



CHRYSLER		DCP06020	
Compressor Type	10S17C	Clutch Type	
Refrigerant Type	R134a	Voltage	12
Oil Type	ND-oil 8	Pulley Type	Magnetic Clutch
Oil Quantity	140	Diameter	120



CHRYSLER		DCP06025	
Compressor Type	10S17C	Clutch Type	
Refrigerant Type	R134a	Voltage	12
Oil Type	ND-oil 8	Pulley Type	Magnetic Clutch
Oil Quantity	180	Diameter	120

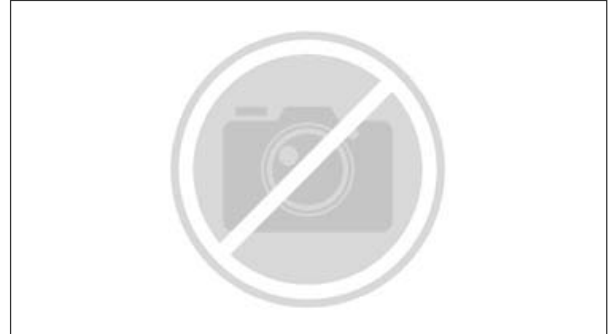

CHRYSLER		DCP06021	
Compressor Type	10S17C	Clutch Type	L50T
Refrigerant Type	R134a	Voltage	12
Oil Type	ND-oil 8	Pulley Type	Magnetic Clutch
Oil Quantity	140	Diameter	120



CHRYSLER		DCP06026	
Compressor Type	10S17E	Clutch Type	
Refrigerant Type	R134a	Voltage	12
Oil Type	ND-oil 8	Pulley Type	Magnetic Clutch
Oil Quantity	170	Diameter	130

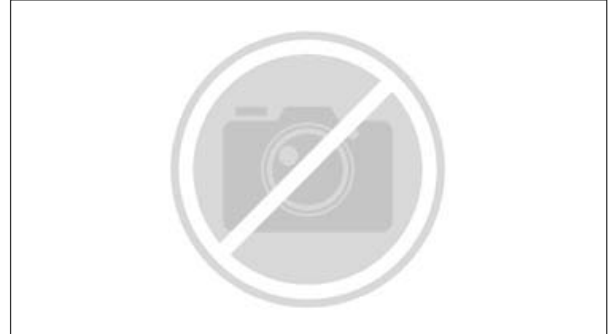

CHRYSLER		DCP06022	
Compressor Type	5SE12C	Clutch Type	
Refrigerant Type	R134a	Voltage	
Oil Type	ND-oil 8	Pulley Type	DL-Pulley
Oil Quantity	120	Diameter	100

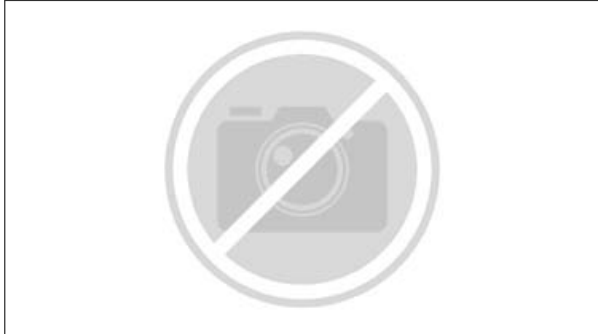

CHRYSLER		DCP06027	
Compressor Type	10S17C	Clutch Type	
Refrigerant Type	R134a	Voltage	12
Oil Type	ND-oil 8	Pulley Type	Magnetic Clutch
Oil Quantity	120	Diameter	125

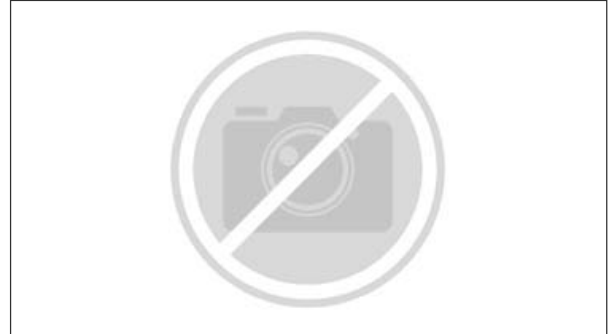

CHRYSLER		DCP06029	
Compressor Type	10SR17C	Clutch Type	
Refrigerant Type	R134a	Voltage	12
Oil Type	ND-oil 8	Pulley Type	Magnetic Clutch
Oil Quantity	170	Diameter	120



FIAT-GROUP		DCP09002	
Compressor Type	5SL12C-T	Clutch Type	CL / LC35S
Refrigerant Type	R134a	Voltage	12
Oil Type	ND-oil 8	Pulley Type	Magnetic Clutch
Oil Quantity	90	Diameter	115



CITROEN-PEUGEOT		DCP07010	
Compressor Type	6SEL16C	Clutch Type	DL / B-PC
Refrigerant Type	R134a	Voltage	
Oil Type	ND-oil 8	Pulley Type	DL-Pulley
Oil Quantity	180	Diameter	118.6



FIAT-GROUP		DCP09003	
Compressor Type	SCSC06	Clutch Type	LC20
Refrigerant Type	R134a	Voltage	12
Oil Type	ND-oil 8	Pulley Type	Magnetic Clutch
Oil Quantity	65	Diameter	100



FIAT-GROUP		DCP09001	
Compressor Type	SCS08C	Clutch Type	CL / LC35S
Refrigerant Type	R134a	Voltage	12
Oil Type	ND-oil 8	Pulley Type	Magnetic Clutch
Oil Quantity	80	Diameter	115



FIAT-GROUP		DCP09004	
Compressor Type	SCSB06C	Clutch Type	CL / LC20B
Refrigerant Type	R134a	Voltage	12
Oil Type	ND-oil 8	Pulley Type	Magnetic Clutch
Oil Quantity	50	Diameter	100



FIAT-GROUP		DCP09005	
Compressor Type	SC08C	Clutch Type	CL / LC35S
Refrigerant Type	R134a	Voltage	12
Oil Type	ND-oil 8	Pulley Type	Magnetic Clutch
Oil Quantity	80	Diameter	115



FIAT-GROUP		DCP09008	
Compressor Type	5SL12C-J	Clutch Type	CL / LC35S
Refrigerant Type	R134a	Voltage	12
Oil Type	ND-oil 8	Pulley Type	Magnetic Clutch
Oil Quantity	90	Diameter	130



FIAT-GROUP		DCP09006	
Compressor Type	TV12SC	Clutch Type	L50
Refrigerant Type	R134a	Voltage	12
Oil Type	ND-oil 9	Pulley Type	Magnetic Clutch
Oil Quantity	150	Diameter	120



FIAT-GROUP		DCP09009	
Compressor Type	TV12SC	Clutch Type	L50
Refrigerant Type	R134a	Voltage	12
Oil Type	ND-oil 9	Pulley Type	Magnetic Clutch
Oil Quantity	150	Diameter	130



FIAT-GROUP		DCP09007	
Compressor Type	SC08C	Clutch Type	CL / LC35S
Refrigerant Type	R134a	Voltage	12
Oil Type	ND-oil 8	Pulley Type	Magnetic Clutch
Oil Quantity	80	Diameter	



FIAT-GROUP		DCP09010	
Compressor Type	TV12EC	Clutch Type	L50
Refrigerant Type	R134a	Voltage	12
Oil Type	ND-oil 9	Pulley Type	Magnetic Clutch
Oil Quantity	150	Diameter	



FIAT-GROUP		DCP09011	
Compressor Type	-	Clutch Type	
Refrigerant Type	R134a	Voltage	
Oil Type	ND-oil 9	Pulley Type	DL-Pulley
Oil Quantity		Diameter	



FIAT-GROUP		DCP09014	
Compressor Type	TV14EC	Clutch Type	L50
Refrigerant Type	R134a	Voltage	12
Oil Type	ND-oil 9	Pulley Type	Magnetic Clutch
Oil Quantity	150	Diameter	120



FIAT-GROUP		DCP09012	
Compressor Type	TV14EC	Clutch Type	L50
Refrigerant Type	R134a	Voltage	12
Oil Type	ND-oil 9	Pulley Type	Magnetic Clutch
Oil Quantity	150	Diameter	120



FIAT-GROUP		DCP09015	
Compressor Type	TV14EC	Clutch Type	L50
Refrigerant Type	R134a	Voltage	12
Oil Type	ND-oil 9	Pulley Type	Magnetic Clutch
Oil Quantity	150	Diameter	120



FIAT-GROUP		DCP09013	
Compressor Type	TV12SC	Clutch Type	
Refrigerant Type	R134a	Voltage	
Oil Type	ND-oil 8	Pulley Type	DL-Pulley
Oil Quantity	150	Diameter	126



FIAT-GROUP		DCP09016	
Compressor Type	5SL12C	Clutch Type	DL / B-PCW
Refrigerant Type	R134a	Voltage	
Oil Type	ND-oil 8	Pulley Type	DL-Pulley
Oil Quantity	90	Diameter	110



FIAT-GROUP		DCP09017	
Compressor Type	5SL12C	Clutch Type	DL / B-PC
Refrigerant Type	R134a	Voltage	
Oil Type	ND-oil 8	Pulley Type	DL-Pulley
Oil Quantity	90	Diameter	110



FIAT-GROUP		DCP09034	
Compressor Type	5SEL12	Clutch Type	
Refrigerant Type	R134a	Voltage	
Oil Type	ND-oil 8	Pulley Type	DL-Pulley
Oil Quantity	80	Diameter	110



FIAT-GROUP		DCP09020	
Compressor Type	5SL12C	Clutch Type	DL / B-PCW
Refrigerant Type	R134a	Voltage	
Oil Type	ND-oil 8	Pulley Type	DL-Pulley
Oil Quantity	90	Diameter	110



FIAT-GROUP		DCP09060	
Compressor Type	SCSC06	Clutch Type	
Refrigerant Type	R134a; R12	Voltage	12
Oil Type	ND-Oil 12	Pulley Type	Magnetic Clutch
Oil Quantity	60	Diameter	100



FIAT-GROUP		DCP09032	
Compressor Type	5SL12C	Clutch Type	DL
Refrigerant Type	R134a	Voltage	
Oil Type	ND-oil 8	Pulley Type	DL-Pulley
Oil Quantity	80	Diameter	110



FIAT-GROUP		DCP09061	
Compressor Type	SCSB06C	Clutch Type	
Refrigerant Type	R134a; R12	Voltage	12
Oil Type	ND-Oil 12	Pulley Type	Magnetic Clutch
Oil Quantity	50	Diameter	100



FIAT-GROUP		DCP09062	
Compressor Type	5SL12	Clutch Type	
Refrigerant Type	R134a; R12	Voltage	
Oil Type	ND-Oil 12	Pulley Type	DL-Pulley
Oil Quantity	90	Diameter	110



JAGUAR		DCP11001	
Compressor Type	10PA17C	Clutch Type	L50
Refrigerant Type	R134a	Voltage	12
Oil Type	ND-oil 8	Pulley Type	Magnetic Clutch
Oil Quantity	190	Diameter	120



FIAT-GROUP		DCP09063	
Compressor Type	5SL12	Clutch Type	
Refrigerant Type	R134a; R12	Voltage	
Oil Type	ND-Oil 12	Pulley Type	DL-Pulley
Oil Quantity	90	Diameter	110



JAGUAR		DCP11002	
Compressor Type	10PA17C	Clutch Type	L50
Refrigerant Type	R134a	Voltage	12
Oil Type	ND-oil 8	Pulley Type	Magnetic Clutch
Oil Quantity	190	Diameter	120



FIAT-GROUP		DCP09064	
Compressor Type	5SL12	Clutch Type	
Refrigerant Type	R134a; R12	Voltage	
Oil Type	ND-Oil 12	Pulley Type	DL-Pulley
Oil Quantity	90	Diameter	110



JAGUAR		DCP11003	
Compressor Type	10PA17C	Clutch Type	L50
Refrigerant Type	R134a	Voltage	12
Oil Type	ND-oil 8	Pulley Type	Magnetic Clutch
Oil Quantity	190	Diameter	120



# A/C Components | Photo Guide - Compressors

JAGUAR		DCP11007	
Compressor Type	10PA17C	Clutch Type	L50
Refrigerant Type	R134a	Voltage	12
Oil Type	ND-oil 8	Pulley Type	Magnetic Clutch
Oil Quantity	190	Diameter	120



JAGUAR		DCP11011	
Compressor Type	7SEU16C	Clutch Type	
Refrigerant Type	R134a	Voltage	
Oil Type	ND-oil 8	Pulley Type	DL-Pulley
Oil Quantity	208	Diameter	110



JAGUAR		DCP11008	
Compressor Type	5SA12C	Clutch Type	CL / LC35S
Refrigerant Type	R134a	Voltage	12
Oil Type	ND-oil 8	Pulley Type	Magnetic Clutch
Oil Quantity	150	Diameter	115



JAGUAR		DCP11012	
Compressor Type	7SEU17C	Clutch Type	
Refrigerant Type	R134a	Voltage	
Oil Type	ND-oil 8	Pulley Type	DL-Pulley
Oil Quantity	130	Diameter	120



JAGUAR		DCP11010	
Compressor Type	7SEU16C	Clutch Type	
Refrigerant Type	R134a	Voltage	
Oil Type	ND-oil 8	Pulley Type	DL-Pulley
Oil Quantity	140	Diameter	120



JAGUAR		DCP11045	
Compressor Type	7SEU16C	Clutch Type	
Refrigerant Type	R134a	Voltage	
Oil Type	ND-oil 8	Pulley Type	DL-Pulley
Oil Quantity	140	Diameter	110





IVECO		DCP12001	
Compressor Type	SC08C	Clutch Type	CL / LS30
Refrigerant Type	R134a	Voltage	12
Oil Type	ND-oil 8	Pulley Type	Magnetic Clutch
Oil Quantity	80	Diameter	105



IVECO		DCP12005	
Compressor Type	10PA17C	Clutch Type	L50
Refrigerant Type	R134a	Voltage	12
Oil Type	ND-oil 8	Pulley Type	Magnetic Clutch
Oil Quantity	210	Diameter	120



IVECO		DCP12003	
Compressor Type	10PA17C	Clutch Type	L50
Refrigerant Type	R134a	Voltage	12
Oil Type	ND-oil 8	Pulley Type	Magnetic Clutch
Oil Quantity	210	Diameter	110



IVECO		DCP12008	
Compressor Type	10PA17C	Clutch Type	L50
Refrigerant Type	R134a	Voltage	24
Oil Type	ND-oil 8	Pulley Type	Magnetic Clutch
Oil Quantity	210	Diameter	120



IVECO		DCP12004	
Compressor Type	10PA17C	Clutch Type	L50
Refrigerant Type	R134a	Voltage	12
Oil Type	ND-oil 8	Pulley Type	Magnetic Clutch
Oil Quantity	210	Diameter	120



IVECO		DCP12009	
Compressor Type	10PA17C	Clutch Type	L50
Refrigerant Type	R134a	Voltage	24
Oil Type	ND-oil 8	Pulley Type	Magnetic Clutch
Oil Quantity	210	Diameter	110



IVECO		DCP12012	
Compressor Type	10S17C	Clutch Type	
Refrigerant Type	R134a	Voltage	12
Oil Type	ND-oil 8	Pulley Type	Magnetic Clutch
Oil Quantity	120	Diameter	110



FIAT-GROUP		DCP13010	
Compressor Type	5SL12C	Clutch Type	
Refrigerant Type	R134a	Voltage	12
Oil Type	ND-oil 8	Pulley Type	Magnetic Clutch
Oil Quantity	80	Diameter	110



FIAT-GROUP		DCP13001	
Compressor Type	6CA17A	Clutch Type	CL / L50CA
Refrigerant Type	R134a	Voltage	12
Oil Type	ND-oil 8	Pulley Type	Magnetic Clutch
Oil Quantity	155	Diameter	130



LAND ROVER		DCP14001	
Compressor Type	10PA17C	Clutch Type	L50
Refrigerant Type	R134a	Voltage	12
Oil Type	ND-oil 8	Pulley Type	Magnetic Clutch
Oil Quantity	190	Diameter	130



FIAT-GROUP		DCP13005	
Compressor Type	5SL12C	Clutch Type	
Refrigerant Type	R134a	Voltage	
Oil Type	ND-oil 8	Pulley Type	DL-Pulley
Oil Quantity	110	Diameter	110



LAND ROVER		DCP14002	
Compressor Type	10PA17C	Clutch Type	L50
Refrigerant Type	R134a	Voltage	12
Oil Type	ND-oil 8	Pulley Type	Magnetic Clutch
Oil Quantity	190	Diameter	110



# A/C Components | Photo Guide - Compressors

LAND ROVER		DCP14003	
Compressor Type	10PA17C	Clutch Type	L50
Refrigerant Type	R134a	Voltage	12
Oil Type	ND-oil 8	Pulley Type	Magnetic Clutch
Oil Quantity	190	Diameter	120



LAND ROVER		DCP14006	
Compressor Type	10PA17C	Clutch Type	L50
Refrigerant Type	R134a	Voltage	12
Oil Type	ND-oil 8	Pulley Type	Magnetic Clutch
Oil Quantity	190	Diameter	120



LAND ROVER		DCP14004	
Compressor Type	10PA17C	Clutch Type	L50
Refrigerant Type	R134a	Voltage	12
Oil Type	ND-oil 8	Pulley Type	Magnetic Clutch
Oil Quantity	150	Diameter	120



LAND ROVER		DCP14007	
Compressor Type	10S17C	Clutch Type	CL / L50T
Refrigerant Type	R134a	Voltage	12
Oil Type	ND-oil 8	Pulley Type	Magnetic Clutch
Oil Quantity	150	Diameter	120



LAND ROVER		DCP14005	
Compressor Type	10PA17C	Clutch Type	L50
Refrigerant Type	R134a	Voltage	12
Oil Type	ND-oil 8	Pulley Type	Magnetic Clutch
Oil Quantity	150	Diameter	120



LAND ROVER		DCP14008	
Compressor Type	10S17C	Clutch Type	CL / L50T
Refrigerant Type	R134a	Voltage	12
Oil Type	ND-oil 8	Pulley Type	Magnetic Clutch
Oil Quantity	150	Diameter	120



# A/C Components | Photo Guide - Compressors

LAND ROVER		DCP14012	
Compressor Type	7SEU17C	Clutch Type	DL / B-SC
Refrigerant Type	R134a	Voltage	
Oil Type	ND-oil 8	Pulley Type	DL-Pulley
Oil Quantity	130	Diameter	100



LAND ROVER		DCP14018	
Compressor Type	7SBU16C	Clutch Type	L50S
Refrigerant Type	R134a	Voltage	12
Oil Type	ND-oil 8	Pulley Type	Magnetic Clutch
Oil Quantity	120	Diameter	120



LAND ROVER		DCP14013	
Compressor Type	7SEU17C	Clutch Type	DL / B-SC
Refrigerant Type	R134a	Voltage	
Oil Type	ND-oil 8	Pulley Type	DL-Pulley
Oil Quantity	130	Diameter	110



LAND ROVER		DCP14019	
Compressor Type	7SEU17C	Clutch Type	
Refrigerant Type	R134a	Voltage	
Oil Type	ND-oil 8	Pulley Type	DL-Pulley
Oil Quantity	130	Diameter	110



LAND ROVER		DCP14014	
Compressor Type	7SEU17C	Clutch Type	DL / B-SC
Refrigerant Type	R134a	Voltage	
Oil Type	ND-oil 8	Pulley Type	DL-Pulley
Oil Quantity	130	Diameter	110



LAND ROVER		DCP14020	
Compressor Type	7SEU17C	Clutch Type	
Refrigerant Type	R134a	Voltage	
Oil Type	ND-oil 8	Pulley Type	DL-Pulley
Oil Quantity	130	Diameter	110



# A/C Components | Photo Guide - Compressors

GM		DCP15001	
Compressor Type	10S17F	Clutch Type	
Refrigerant Type	R134a	Voltage	12
Oil Type	ND-oil 8	Pulley Type	Magnetic Clutch
Oil Quantity	210	Diameter	110

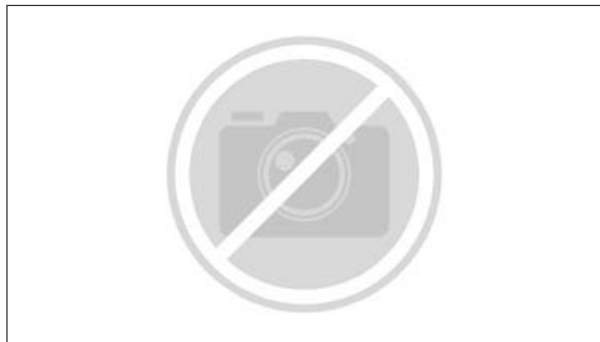

MERCEDES-BENZ		DCP17003	
Compressor Type	10P17C	Clutch Type	
Refrigerant Type	R134a	Voltage	12
Oil Type	ND-oil 8	Pulley Type	Magnetic Clutch
Oil Quantity	150	Diameter	128



MERCEDES-BENZ		DCP17001	
Compressor Type	10P15C	Clutch Type	
Refrigerant Type	R134a	Voltage	12
Oil Type	ND-oil 8	Pulley Type	Magnetic Clutch
Oil Quantity	150	Diameter	120



MERCEDES-BENZ		DCP17005	
Compressor Type	10PA20C	Clutch Type	L50
Refrigerant Type	R134a	Voltage	12
Oil Type	ND-oil 8	Pulley Type	Magnetic Clutch
Oil Quantity	170	Diameter	120



MERCEDES-BENZ		DCP17002	
Compressor Type	10P15C	Clutch Type	
Refrigerant Type	R134a	Voltage	12
Oil Type	ND-oil 8	Pulley Type	Magnetic Clutch
Oil Quantity	150	Diameter	122



MERCEDES-BENZ		DCP17006	
Compressor Type	10PA20C	Clutch Type	L50
Refrigerant Type	R134a	Voltage	12
Oil Type	ND-oil 8	Pulley Type	Magnetic Clutch
Oil Quantity	170	Diameter	120



MERCEDES-BENZ		DCP17007	
Compressor Type	10PA20C	Clutch Type	L50
Refrigerant Type	R134a	Voltage	12
Oil Type	ND-oil 8	Pulley Type	Magnetic Clutch
Oil Quantity	170	Diameter	120



MERCEDES-BENZ		DCP17011	
Compressor Type	10PA17C	Clutch Type	L50
Refrigerant Type	R134a	Voltage	12
Oil Type	ND-oil 8	Pulley Type	Magnetic Clutch
Oil Quantity	150	Diameter	120



MERCEDES-BENZ		DCP17008	
Compressor Type	10PA20C	Clutch Type	L50
Refrigerant Type	R134a	Voltage	12
Oil Type	ND-oil 8	Pulley Type	Magnetic Clutch
Oil Quantity	170	Diameter	130



MERCEDES-BENZ		DCP17012	
Compressor Type	10PA15C	Clutch Type	L50
Refrigerant Type	R134a	Voltage	12
Oil Type	ND-oil 8	Pulley Type	Magnetic Clutch
Oil Quantity	150	Diameter	120



MERCEDES-BENZ		DCP17010	
Compressor Type	10PA17C	Clutch Type	L50
Refrigerant Type	R134a	Voltage	12
Oil Type	ND-oil 8	Pulley Type	Magnetic Clutch
Oil Quantity	150	Diameter	120



MERCEDES-BENZ		DCP17013	
Compressor Type	10PA15C	Clutch Type	L50
Refrigerant Type	R134a	Voltage	12
Oil Type	ND-oil 8	Pulley Type	Magnetic Clutch
Oil Quantity	150	Diameter	130



MERCEDES-BENZ		DCP17014	
Compressor Type	6CA17C	Clutch Type	CL / L50CA
Refrigerant Type	R134a	Voltage	12
Oil Type	ND-oil 8	Pulley Type	Magnetic Clutch
Oil Quantity	145	Diameter	120



MERCEDES-BENZ		DCP17019	
Compressor Type	10PA17C	Clutch Type	L50
Refrigerant Type	R134a	Voltage	12
Oil Type	ND-oil 8	Pulley Type	Magnetic Clutch
Oil Quantity	150	Diameter	120



MERCEDES-BENZ		DCP17015	
Compressor Type	10PA20C	Clutch Type	L50
Refrigerant Type	R134a	Voltage	12
Oil Type	ND-oil 8	Pulley Type	Magnetic Clutch
Oil Quantity	170	Diameter	120



MERCEDES-BENZ		DCP17020	
Compressor Type	10PA17C	Clutch Type	L50
Refrigerant Type	R134a	Voltage	12
Oil Type	ND-oil 8	Pulley Type	Magnetic Clutch
Oil Quantity	145	Diameter	120



MERCEDES-BENZ		DCP17017	
Compressor Type	10PA20C	Clutch Type	L50
Refrigerant Type	R134a	Voltage	12
Oil Type	ND-oil 8	Pulley Type	Magnetic Clutch
Oil Quantity	165	Diameter	120



MERCEDES-BENZ		DCP17021	
Compressor Type	10P15C	Clutch Type	CL / P40
Refrigerant Type	R134a	Voltage	24
Oil Type	ND-oil 8	Pulley Type	Magnetic Clutch
Oil Quantity	160	Diameter	135



# A/C Components | Photo Guide - Compressors

MERCEDES-BENZ		DCP17023	
Compressor Type	7SBU16C	Clutch Type	L50S
Refrigerant Type	R134a	Voltage	12
Oil Type	ND-oil 8	Pulley Type	Magnetic Clutch
Oil Quantity	120	Diameter	120



MERCEDES-BENZ		DCP17026	
Compressor Type	7SEU17C	Clutch Type	DL / B-PC
Refrigerant Type	R134a	Voltage	
Oil Type	ND-oil 8	Pulley Type	DL-Pulley
Oil Quantity	120	Diameter	110



MERCEDES-BENZ		DCP17024	
Compressor Type	7SBU16C	Clutch Type	CL / LS45S
Refrigerant Type	R134a	Voltage	12
Oil Type	ND-oil 8	Pulley Type	Magnetic Clutch
Oil Quantity	175	Diameter	120



MERCEDES-BENZ		DCP17031	
Compressor Type	10PA15C	Clutch Type	L50
Refrigerant Type	R134a	Voltage	12
Oil Type	ND-oil 8	Pulley Type	Magnetic Clutch
Oil Quantity	160	Diameter	130



MERCEDES-BENZ		DCP17025	
Compressor Type	6SEU12C	Clutch Type	DL / R-SC
Refrigerant Type	R134a	Voltage	
Oil Type	ND-oil 8	Pulley Type	DL-Pulley
Oil Quantity	130	Diameter	110



MERCEDES-BENZ		DCP17033	
Compressor Type	10PA15C	Clutch Type	L50
Refrigerant Type	R134a	Voltage	24
Oil Type	ND-oil 8	Pulley Type	Magnetic Clutch
Oil Quantity	170	Diameter	128





MERCEDES-BENZ		DCP17034	
Compressor Type	10PA15C	Clutch Type	L50
Refrigerant Type	R134a	Voltage	24
Oil Type	ND-oil 8	Pulley Type	Magnetic Clutch
Oil Quantity	150	Diameter	130



MERCEDES-BENZ		DCP17038	
Compressor Type	7SEU17C	Clutch Type	DL / B-PC
Refrigerant Type	R134a	Voltage	
Oil Type	ND-oil 8	Pulley Type	DL-Pulley
Oil Quantity	150	Diameter	120



MERCEDES-BENZ		DCP17035	
Compressor Type	7SBU16C	Clutch Type	L50S
Refrigerant Type	R134a	Voltage	24
Oil Type	ND-oil 8	Pulley Type	Magnetic Clutch
Oil Quantity	175	Diameter	130



MERCEDES-BENZ		DCP17039	
Compressor Type	7SEU17C	Clutch Type	DL / B-PC
Refrigerant Type	R134a	Voltage	
Oil Type	ND-oil 8	Pulley Type	DL-Pulley
Oil Quantity	150	Diameter	100



MERCEDES-BENZ		DCP17036	
Compressor Type	7SBU16C	Clutch Type	L50S
Refrigerant Type	R134a	Voltage	24
Oil Type	ND-oil 8	Pulley Type	Magnetic Clutch
Oil Quantity	175	Diameter	130



MERCEDES-BENZ		DCP17040	
Compressor Type	7SEU17C	Clutch Type	DL / B-PC
Refrigerant Type	R134a	Voltage	
Oil Type	ND-oil 8	Pulley Type	DL-Pulley
Oil Quantity	150	Diameter	110



# A/C Components | Photo Guide - Compressors

MERCEDES-BENZ		DCP17041	
Compressor Type	7SEU17C	Clutch Type	DL / R-SC
Refrigerant Type	R134a	Voltage	
Oil Type	ND-oil 8	Pulley Type	DL-Pulley
Oil Quantity	120	Diameter	103



MERCEDES-BENZ		DCP17046	
Compressor Type	6SEU14C	Clutch Type	DL / B-PC
Refrigerant Type	R134a	Voltage	
Oil Type	ND-oil 8	Pulley Type	DL-Pulley
Oil Quantity	120	Diameter	110



MERCEDES-BENZ		DCP17043	
Compressor Type	7SEU17C	Clutch Type	DL / B-PC
Refrigerant Type	R134a	Voltage	
Oil Type	ND-oil 8	Pulley Type	DL-Pulley
Oil Quantity	120	Diameter	100



MERCEDES-BENZ		DCP17050	
Compressor Type	6SEU14C	Clutch Type	DL / B-SC
Refrigerant Type	R134a	Voltage	
Oil Type	ND-oil 8	Pulley Type	DL-Pulley
Oil Quantity	130	Diameter	110



MERCEDES-BENZ		DCP17045	
Compressor Type	7SEU17C	Clutch Type	DL / B-PC
Refrigerant Type	R134a	Voltage	
Oil Type	ND-oil 8	Pulley Type	DL-Pulley
Oil Quantity	150	Diameter	100



MERCEDES-BENZ		DCP17051	
Compressor Type	6SEU14C	Clutch Type	DL / B-PC
Refrigerant Type	R134a	Voltage	
Oil Type	ND-oil 8	Pulley Type	DL-Pulley
Oil Quantity	120	Diameter	120



MERCEDES-BENZ		DCP17053	
Compressor Type	7SEU17C	Clutch Type	DL / B-PC
Refrigerant Type	R134a	Voltage	
Oil Type	ND-oil 8	Pulley Type	DL-Pulley
Oil Quantity	150	Diameter	110



SMART		DCP17056	
Compressor Type	5SE09C	Clutch Type	DL
Refrigerant Type	R134a	Voltage	
Oil Type	ND-oil 8	Pulley Type	DL-Pulley
Oil Quantity	90	Diameter	100



SMART		DCP17054	
Compressor Type	5SE09C	Clutch Type	DL
Refrigerant Type	R134a	Voltage	
Oil Type	ND-oil 8	Pulley Type	DL-Pulley
Oil Quantity	90	Diameter	100



MERCEDES-BENZ		DCP17058	
Compressor Type	7SEU17C	Clutch Type	DL / B-PC
Refrigerant Type	R134a	Voltage	
Oil Type	ND-oil 8	Pulley Type	DL-Pulley
Oil Quantity	110	Diameter	110



MERCEDES-BENZ		DCP17055	
Compressor Type	7SEU17C	Clutch Type	DL / B-PC
Refrigerant Type	R134a	Voltage	
Oil Type	ND-oil 8	Pulley Type	DL-Pulley
Oil Quantity	140	Diameter	100



MERCEDES-BENZ		DCP17059	
Compressor Type	7SEU17C	Clutch Type	DL / B-PC
Refrigerant Type	R134a	Voltage	
Oil Type	ND-oil 8	Pulley Type	DL-Pulley
Oil Quantity	110	Diameter	100



# A/C Components | Photo Guide - Compressors

MERCEDES-BENZ		DCP17060	
Compressor Type	7SEU17C	Clutch Type	DL / B-PC
Refrigerant Type	R134a	Voltage	
Oil Type	ND-oil 8	Pulley Type	DL-Pulley
Oil Quantity	110	Diameter	100



MERCEDES-BENZ		DCP17064	
Compressor Type	7SEU17C	Clutch Type	DL / B-PC
Refrigerant Type	R134a	Voltage	
Oil Type	ND-oil 8	Pulley Type	DL-Pulley
Oil Quantity	170	Diameter	110



MERCEDES-BENZ		DCP17062	
Compressor Type	7SEU17C	Clutch Type	DL / B-PC
Refrigerant Type	R134a	Voltage	
Oil Type	ND-oil 8	Pulley Type	DL-Pulley
Oil Quantity	110	Diameter	100



MERCEDES-BENZ		DCP17065	
Compressor Type	7SEU17C	Clutch Type	DL / B-PC
Refrigerant Type	R134a	Voltage	
Oil Type	ND-oil 8	Pulley Type	DL-Pulley
Oil Quantity	110	Diameter	110



MERCEDES-BENZ		DCP17063	
Compressor Type	7SEU17C	Clutch Type	DL / B-PC
Refrigerant Type	R134a	Voltage	
Oil Type	ND-oil 8	Pulley Type	DL-Pulley
Oil Quantity	140	Diameter	100



MERCEDES-BENZ		DCP17067	
Compressor Type	6SEU16C	Clutch Type	DL / B-PC
Refrigerant Type	R134a	Voltage	
Oil Type	ND-oil 8	Pulley Type	DL-Pulley
Oil Quantity	120	Diameter	100



# A/C Components

## Photo Guide - Compressors

MERCEDES-BENZ		DCP17068	
Compressor Type	6SEU16C	Clutch Type	DL / B-PC
Refrigerant Type	R134a	Voltage	
Oil Type	ND-oil 8	Pulley Type	DL-Pulley
Oil Quantity	120	Diameter	110



MERCEDES-BENZ		DCP17072	
Compressor Type	7SEU17C	Clutch Type	DL / B-PC
Refrigerant Type	R134a	Voltage	
Oil Type	ND-oil 8	Pulley Type	DL-Pulley
Oil Quantity	190	Diameter	110



MERCEDES-BENZ		DCP17070	
Compressor Type	6SEU16C	Clutch Type	DL / B-PC
Refrigerant Type	R134a	Voltage	
Oil Type	ND-oil 8	Pulley Type	DL-Pulley
Oil Quantity	120	Diameter	110



VW-Group		DCP17073	
Compressor Type	7SEU17C	Clutch Type	DL / B-PC
Refrigerant Type	R134a	Voltage	
Oil Type	ND-oil 8	Pulley Type	DL-Pulley
Oil Quantity	190	Diameter	110



MERCEDES-BENZ		DCP17071	
Compressor Type	6SEU16C	Clutch Type	DL / B-PC
Refrigerant Type	R134a	Voltage	
Oil Type	ND-oil 8	Pulley Type	DL-Pulley
Oil Quantity	120	Diameter	100



MERCEDES-BENZ		DCP17080	
Compressor Type	7SBU16C	Clutch Type	CL / LS45S
Refrigerant Type	R134a	Voltage	12
Oil Type	ND-oil 8	Pulley Type	Magnetic Clutch
Oil Quantity	120	Diameter	110



# A/C Components | Photo Guide - Compressors

MERCEDES-BENZ		DCP17084	
Compressor Type	10PA15C	Clutch Type	L50
Refrigerant Type	R134a	Voltage	24
Oil Type	ND-oil 8	Pulley Type	Magnetic Clutch
Oil Quantity	170	Diameter	130



MERCEDES-BENZ		DCP17087	
Compressor Type	6SEU16C	Clutch Type	DL / A1-PD
Refrigerant Type	R134a	Voltage	
Oil Type	ND-oil 8	Pulley Type	DL-Pulley
Oil Quantity	120	Diameter	110



MERCEDES-BENZ		DCP17085	
Compressor Type	7SEU17C	Clutch Type	DL / R-SC
Refrigerant Type	R134a	Voltage	
Oil Type	ND-oil 8	Pulley Type	DL-Pulley
Oil Quantity	140	Diameter	103



MERCEDES-BENZ		DCP17090	
Compressor Type	7SEU17C	Clutch Type	DL / B-PC
Refrigerant Type	R134a	Voltage	
Oil Type	ND-oil 8	Pulley Type	DL-Pulley
Oil Quantity	150	Diameter	100



MERCEDES-BENZ		DCP17086	
Compressor Type	6SEU16C	Clutch Type	DL / B-PC
Refrigerant Type	R134a	Voltage	
Oil Type	ND-oil 8	Pulley Type	DL-Pulley
Oil Quantity	120	Diameter	100



MERCEDES-BENZ		DCP17092	
Compressor Type	10PA15C	Clutch Type	L50
Refrigerant Type	R134a	Voltage	24
Oil Type	ND-oil 8	Pulley Type	Magnetic Clutch
Oil Quantity	150	Diameter	130



# A/C Components

## Photo Guide - Compressors

MERCEDES-BENZ		DCP17095	
Compressor Type	10PA15C	Clutch Type	L50
Refrigerant Type	R134a	Voltage	12
Oil Type	ND-Oil 8	Pulley Type	Magnetic Clutch
Oil Quantity	140	Diameter	143



MERCEDES-BENZ		DCP17102	
Compressor Type	7SEU17C	Clutch Type	DL
Refrigerant Type	R134a	Voltage	
Oil Type	ND-oil 8	Pulley Type	DL-Pulley
Oil Quantity	150	Diameter	100



MERCEDES-BENZ		DCP17100	
Compressor Type	6SEU16C	Clutch Type	DL
Refrigerant Type	R134a	Voltage	
Oil Type	ND-oil 8	Pulley Type	DL-Pulley
Oil Quantity	120	Diameter	110



MERCEDES-BENZ		DCP17103	
Compressor Type	6SEU16C	Clutch Type	DL
Refrigerant Type	R134a	Voltage	
Oil Type	ND-oil 8	Pulley Type	DL-Pulley
Oil Quantity	120	Diameter	120



MERCEDES-BENZ		DCP17101	
Compressor Type	6SEU16C	Clutch Type	DL
Refrigerant Type	R134a	Voltage	
Oil Type	ND-oil 8	Pulley Type	DL-Pulley
Oil Quantity	120	Diameter	120



MERCEDES-BENZ		DCP17104	
Compressor Type	6SEU16C	Clutch Type	A01-PD
Refrigerant Type	R134a	Voltage	
Oil Type	ND-oil 8	Pulley Type	DL-Pulley
Oil Quantity	120	Diameter	100



# A/C Components | Photo Guide - Compressors

MERCEDES-BENZ		DCP17105	
Compressor Type	6SEU16C	Clutch Type	DL
Refrigerant Type	R134a	Voltage	
Oil Type	ND-oil 8	Pulley Type	DL-Pulley
Oil Quantity	120	Diameter	110



MERCEDES-BENZ		DCP17108	
Compressor Type	7SEU17C	Clutch Type	DL
Refrigerant Type	R134a	Voltage	
Oil Type	ND-oil 8	Pulley Type	DL-Pulley
Oil Quantity	150	Diameter	120



MERCEDES-BENZ		DCP17106	
Compressor Type	6SEU16C	Clutch Type	DL
Refrigerant Type	R134a	Voltage	
Oil Type	ND-oil 8	Pulley Type	DL-Pulley
Oil Quantity	120	Diameter	110



MERCEDES-BENZ		DCP17109	
Compressor Type	7SEU17C	Clutch Type	B-PC
Refrigerant Type	R134a	Voltage	
Oil Type	ND-oil 8	Pulley Type	DL-Pulley
Oil Quantity	170	Diameter	110



MERCEDES-BENZ		DCP17107	
Compressor Type	6SEU16C	Clutch Type	DL
Refrigerant Type	R134a	Voltage	
Oil Type	ND-oil 8	Pulley Type	DL-Pulley
Oil Quantity	120	Diameter	110



MERCEDES-BENZ		DCP17110	
Compressor Type	6SEU16C	Clutch Type	DL
Refrigerant Type	R134a	Voltage	
Oil Type	ND-oil 8	Pulley Type	DL-Pulley
Oil Quantity	100	Diameter	110







MERCEDES-BENZ		DCP17112	
Compressor Type	6SEU16C	Clutch Type	A01-PD
Refrigerant Type	R134a	Voltage	
Oil Type	ND-oil 8	Pulley Type	DL-Pulley
Oil Quantity	120	Diameter	110



MERCEDES-BENZ		DCP17115	
Compressor Type	6SEU16C	Clutch Type	A01-PD
Refrigerant Type	R134a	Voltage	
Oil Type	ND-oil 8	Pulley Type	DL-Pulley
Oil Quantity	120	Diameter	120



MERCEDES-BENZ		DCP17113	
Compressor Type	7SBU16C	Clutch Type	L50S
Refrigerant Type	R134a	Voltage	24
Oil Type	ND-oil 8	Pulley Type	Magnetic Clutch
Oil Quantity	175	Diameter	130



MERCEDES-BENZ		DCP17119	
Compressor Type	7SEU17C	Clutch Type	DL
Refrigerant Type	R134a	Voltage	
Oil Type	ND-oil 8	Pulley Type	DL-Pulley
Oil Quantity	160	Diameter	110



MERCEDES-BENZ		DCP17114	
Compressor Type	10S17C	Clutch Type	L50T
Refrigerant Type	R134a	Voltage	
Oil Type	ND-oil 8	Pulley Type	DL-Pulley
Oil Quantity	220	Diameter	120



MERCEDES-BENZ		DCP17120	
Compressor Type	6SEU16C	Clutch Type	A01-PD
Refrigerant Type	R134a	Voltage	
Oil Type	ND-oil 8	Pulley Type	DL-Pulley
Oil Quantity	120	Diameter	110



MERCEDES-BENZ		DCP17121	
Compressor Type	10S17C	Clutch Type	L50T
Refrigerant Type	R134a	Voltage	12
Oil Type	ND-oil 8	Pulley Type	Magnetic Clutch
Oil Quantity	160	Diameter	130



MERCEDES-BENZ		DCP17126	
Compressor Type	7SEU17C	Clutch Type	
Refrigerant Type	R134a	Voltage	12
Oil Type	ND-oil 8	Pulley Type	Magnetic Clutch
Oil Quantity	110	Diameter	110



MERCEDES-BENZ		DCP17122	
Compressor Type	10S17C	Clutch Type	L50T
Refrigerant Type	R134a	Voltage	
Oil Type	ND-oil 8	Pulley Type	DL-Pulley
Oil Quantity	160	Diameter	120



MERCEDES-BENZ		DCP17127	
Compressor Type	7SEU17C	Clutch Type	
Refrigerant Type	R134a	Voltage	
Oil Type	ND-oil 8	Pulley Type	DL-Pulley
Oil Quantity	110	Diameter	115



MERCEDES-BENZ		DCP17125	
Compressor Type	7SBU16C	Clutch Type	L50S
Refrigerant Type	R134a	Voltage	12
Oil Type	ND-oil 8	Pulley Type	Magnetic Clutch
Oil Quantity	175	Diameter	130



MERCEDES-BENZ		DCP17128	
Compressor Type	6SEU16C	Clutch Type	A01-PD
Refrigerant Type	R134a	Voltage	
Oil Type	ND-oil 8	Pulley Type	DL-Pulley
Oil Quantity	120	Diameter	100



MERCEDES-BENZ		DCP17129	
Compressor Type	7SEU17C	Clutch Type	B-PC
Refrigerant Type	R134a	Voltage	
Oil Type	ND-oil 8	Pulley Type	DL-Pulley
Oil Quantity	140	Diameter	110

MERCEDES-BENZ		DCP17132	
Compressor Type	7SEU17C	Clutch Type	B-PC
Refrigerant Type	R134a	Voltage	
Oil Type	ND-oil 8	Pulley Type	DL-Pulley
Oil Quantity	110	Diameter	110

MERCEDES-BENZ		DCP17130	
Compressor Type	7SEU17C	Clutch Type	B-PC
Refrigerant Type	R134a	Voltage	
Oil Type	ND-oil 8	Pulley Type	DL-Pulley
Oil Quantity	150	Diameter	110

MERCEDES-BENZ		DCP17133	
Compressor Type	7SEU17C	Clutch Type	B-PC
Refrigerant Type	R134a	Voltage	
Oil Type	ND-oil 8	Pulley Type	DL-Pulley
Oil Quantity	110	Diameter	110

MERCEDES-BENZ		DCP17131	
Compressor Type	7SEU17C	Clutch Type	B-PC
Refrigerant Type	R134a	Voltage	
Oil Type	ND-oil 8	Pulley Type	DL-Pulley
Oil Quantity	110	Diameter	100

MERCEDES-BENZ		DCP17135	
Compressor Type	7SEU17C	Clutch Type	B-PC
Refrigerant Type	R134a	Voltage	
Oil Type	ND-oil 8	Pulley Type	DL-Pulley
Oil Quantity	110	Diameter	110

# A/C Components | Photo Guide - Compressors

MERCEDES-BENZ		DCP17138	
Compressor Type	7SEU17C	Clutch Type	
Refrigerant Type	R134a	Voltage	
Oil Type	ND-oil 8	Pulley Type	DL-Pulley
Oil Quantity	110	Diameter	100



MERCEDES-BENZ		DCP17142	
Compressor Type	7SEU17C	Clutch Type	
Refrigerant Type	R134a	Voltage	
Oil Type	ND-oil 8	Pulley Type	DL-Pulley
Oil Quantity	150	Diameter	110



MERCEDES-BENZ		DCP17139	
Compressor Type	7SEU17C	Clutch Type	
Refrigerant Type	R134a	Voltage	
Oil Type	ND-oil 8	Pulley Type	DL-Pulley
Oil Quantity	110	Diameter	110



MERCEDES-BENZ		DCP17143	
Compressor Type	7SEU17C	Clutch Type	
Refrigerant Type	R134a	Voltage	
Oil Type	ND-oil 8	Pulley Type	DL-Pulley
Oil Quantity	110	Diameter	100



MERCEDES-BENZ		DCP17140	
Compressor Type	6SBU16C	Clutch Type	
Refrigerant Type	R134a	Voltage	12
Oil Type	ND-oil 8	Pulley Type	Magnetic Clutch
Oil Quantity	120	Diameter	110



MERCEDES-BENZ		DCP17144	
Compressor Type	7SEU16C	Clutch Type	
Refrigerant Type	R134a	Voltage	
Oil Type	ND-oil 8	Pulley Type	DL-Pulley
Oil Quantity	120	Diameter	110



MERCEDES-BENZ		DCP17146	
Compressor Type	7SEU17C	Clutch Type	DL
Refrigerant Type	R134a	Voltage	
Oil Type	ND-oil 8	Pulley Type	DL-Pulley
Oil Quantity	150	Diameter	100



MERCEDES-BENZ		DCP17150	
Compressor Type	10S17C	Clutch Type	L50T
Refrigerant Type	R134a	Voltage	12
Oil Type	ND-oil 8	Pulley Type	Magnetic Clutch
Oil Quantity	160	Diameter	130



MERCEDES-BENZ		DCP17147	
Compressor Type	10PA20C	Clutch Type	L50
Refrigerant Type	R134a	Voltage	12
Oil Type	ND-oil 8	Pulley Type	Magnetic Clutch
Oil Quantity	160	Diameter	120



MERCEDES-BENZ		DCP17151	
Compressor Type	7SBU17C	Clutch Type	LS45S
Refrigerant Type	R134a	Voltage	12
Oil Type	ND-oil 8	Pulley Type	Magnetic Clutch
Oil Quantity	190	Diameter	110



MERCEDES-BENZ		DCP17148	
Compressor Type	6SBU16C	Clutch Type	LS45S
Refrigerant Type	R134a	Voltage	12
Oil Type	ND-oil 8	Pulley Type	Magnetic Clutch
Oil Quantity	120	Diameter	110



MERCEDES-BENZ		DCP17152	
Compressor Type	7SEU17C	Clutch Type	
Refrigerant Type	R134a	Voltage	
Oil Type	ND-oil 8	Pulley Type	DL-Pulley
Oil Quantity	150	Diameter	120



# A/C Components | Photo Guide - Compressors

MERCEDES-BENZ		DCP17153	
Compressor Type	7SEU16C	Clutch Type	DL
Refrigerant Type	R134a	Voltage	
Oil Type	ND-Oil 8	Pulley Type	DL-Pulley
Oil Quantity	120	Diameter	110



MERCEDES-BENZ		DCP17156	
Compressor Type	6SEU16C	Clutch Type	
Refrigerant Type	R134a	Voltage	12
Oil Type	ND-oil 8	Pulley Type	Magnetic Clutch
Oil Quantity	120	Diameter	115



MERCEDES-BENZ		DCP17154	
Compressor Type	6SBU16C	Clutch Type	
Refrigerant Type	R134a	Voltage	12
Oil Type	ND-oil 8	Pulley Type	Magnetic Clutch
Oil Quantity	120	Diameter	110



MERCEDES-BENZ		DCP17157	
Compressor Type	6SBU16C	Clutch Type	
Refrigerant Type	R134a	Voltage	12
Oil Type	ND-oil 8	Pulley Type	Magnetic Clutch
Oil Quantity	120	Diameter	110



MERCEDES-BENZ		DCP17155	
Compressor Type	6SBU16C	Clutch Type	
Refrigerant Type	R134a	Voltage	12
Oil Type	ND-oil 8	Pulley Type	Magnetic Clutch
Oil Quantity	120	Diameter	110



MERCEDES-BENZ		DCP17158	
Compressor Type	6SEU16C	Clutch Type	
Refrigerant Type	R134a	Voltage	
Oil Type	ND-oil 8	Pulley Type	DL-Pulley
Oil Quantity	120	Diameter	115



MERCEDES-BENZ		DCP17159	
Compressor Type	6SEU16C	Clutch Type	DL
Refrigerant Type	R134a	Voltage	
Oil Type	ND-Oil 8	Pulley Type	DL-Pulley
Oil Quantity	120	Diameter	115



MERCEDES-BENZ		DCP17162	
Compressor Type	6SEU16C	Clutch Type	DL
Refrigerant Type	R134a	Voltage	
Oil Type	ND-Oil 8	Pulley Type	DL-Pulley
Oil Quantity	140	Diameter	110



MERCEDES-BENZ		DCP17160	
Compressor Type	7SEU17C	Clutch Type	DL
Refrigerant Type	R134a	Voltage	
Oil Type	ND-Oil 8	Pulley Type	DL-Pulley
Oil Quantity	140	Diameter	100



MERCEDES-BENZ		DCP17163	
Compressor Type	6SEU16C	Clutch Type	DL
Refrigerant Type	R134a	Voltage	
Oil Type	ND-Oil 8	Pulley Type	DL-Pulley
Oil Quantity	140	Diameter	110



MERCEDES-BENZ		DCP17161	
Compressor Type	6SEU16C	Clutch Type	DL
Refrigerant Type	R134a	Voltage	
Oil Type	ND-Oil 8	Pulley Type	DL-Pulley
Oil Quantity	120	Diameter	110



MERCEDES-BENZ		DCP17164	
Compressor Type	6SEU16C	Clutch Type	DL
Refrigerant Type	R134a	Voltage	
Oil Type	ND-Oil 8	Pulley Type	DL-Pulley
Oil Quantity	120	Diameter	115



# A/C Components | Photo Guide - Compressors

MERCEDES-BENZ		DCP17165	
Compressor Type	6SBU16C	Clutch Type	DL
Refrigerant Type	R134a	Voltage	12
Oil Type	ND-Oil 8	Pulley Type	DL-Pulley
Oil Quantity	120	Diameter	110



MERCEDES-BENZ		DCP17168	
Compressor Type	6SBU16C	Clutch Type	DL
Refrigerant Type	R134a	Voltage	12
Oil Type	ND-Oil 8	Pulley Type	Magnetic Clutch
Oil Quantity	120	Diameter	115



MERCEDES-BENZ		DCP17166	
Compressor Type	6SEU16C	Clutch Type	DL
Refrigerant Type	R134a	Voltage	
Oil Type	ND-Oil 8	Pulley Type	DL-Pulley
Oil Quantity	120	Diameter	115



MERCEDES-BENZ		DCP17169	
Compressor Type	6SBU16C	Clutch Type	
Refrigerant Type	R134a	Voltage	12
Oil Type	ND-Oil 8	Pulley Type	Magnetic Clutch
Oil Quantity	120	Diameter	115



MERCEDES-BENZ		DCP17167	
Compressor Type	6SEU16C	Clutch Type	DL
Refrigerant Type	R134a	Voltage	
Oil Type	ND-Oil 8	Pulley Type	DL-Pulley
Oil Quantity	120	Diameter	115



MERCEDES-BENZ		DCP17171	
Compressor Type	6SEL14C	Clutch Type	
Refrigerant Type	R134a	Voltage	
Oil Type	ND-oil 8	Pulley Type	DL-Pulley
Oil Quantity	110	Diameter	115





MERCEDES-BENZ		DCP17176	
Compressor Type	6SBU16C	Clutch Type	
Refrigerant Type	R134a	Voltage	12
Oil Type	ND-oil 8	Pulley Type	Magnetic Clutch
Oil Quantity	120	Diameter	115



MERCEDES-BENZ		DCP17179	
Compressor Type	6SBU16C	Clutch Type	
Refrigerant Type	R134a	Voltage	12
Oil Type	ND-oil 8	Pulley Type	Magnetic Clutch
Oil Quantity	120	Diameter	110



MERCEDES-BENZ		DCP17177	
Compressor Type	6SBU16C	Clutch Type	
Refrigerant Type	R134a	Voltage	12
Oil Type	ND-oil 8	Pulley Type	Magnetic Clutch
Oil Quantity	120	Diameter	115



MERCEDES-BENZ		DCP17180	
Compressor Type	7SEU16C	Clutch Type	
Refrigerant Type	R134a	Voltage	
Oil Type	ND-oil 8	Pulley Type	DL-Pulley
Oil Quantity	150	Diameter	120



MERCEDES-BENZ		DCP17178	
Compressor Type	6SBU16C	Clutch Type	
Refrigerant Type	R134a	Voltage	12
Oil Type	ND-oil 8	Pulley Type	Magnetic Clutch
Oil Quantity	120	Diameter	110



MERCEDES-BENZ		DCP17181	
Compressor Type	6SBU16C	Clutch Type	
Refrigerant Type	R134a	Voltage	12
Oil Type	ND-oil 8	Pulley Type	Magnetic Clutch
Oil Quantity	140	Diameter	110



# A/C Components | Photo Guide - Compressors

MERCEDES-BENZ		DCP17182	
Compressor Type	6SEU16C	Clutch Type	
Refrigerant Type	R134a	Voltage	
Oil Type	ND-oil 8	Pulley Type	DL-Pulley
Oil Quantity	120	Diameter	110



MERCEDES-BENZ		DCP17501	
Compressor Type	10PA15C	Clutch Type	L50
Refrigerant Type	R134a	Voltage	12
Oil Type	ND-oil 8	Pulley Type	Magnetic Clutch
Oil Quantity	245	Diameter	130



MERCEDES-BENZ		DCP17185	
Compressor Type	10S15C	Clutch Type	
Refrigerant Type	R134a	Voltage	24
Oil Type	ND-oil 8	Pulley Type	Magnetic Clutch
Oil Quantity	100	Diameter	130



MERCEDES-BENZ		DCP17505	
Compressor Type	10PA15C	Clutch Type	L50
Refrigerant Type	R134a	Voltage	12
Oil Type	ND-oil 8	Pulley Type	Magnetic Clutch
Oil Quantity	200	Diameter	130



MERCEDES-BENZ		DCP17186	
Compressor Type	10S15C	Clutch Type	
Refrigerant Type	R134a	Voltage	24
Oil Type	ND-oil 8	Pulley Type	Magnetic Clutch
Oil Quantity	100	Diameter	140



MERCEDES-BENZ		DCP17508	
Compressor Type	7SBU16C	Clutch Type	
Refrigerant Type	R134a	Voltage	12
Oil Type	ND-oil 8	Pulley Type	Magnetic Clutch
Oil Quantity	175	Diameter	130



# A/C Components

## Photo Guide - Compressors

GM		DCP20001	
Compressor Type	6CA17C	Clutch Type	CL / L50CA
Refrigerant Type	R134a	Voltage	12
Oil Type	ND-oil 8	Pulley Type	Magnetic Clutch
Oil Quantity	155	Diameter	120



GM		DCP20005	
Compressor Type	7SBU16C	Clutch Type	L50S
Refrigerant Type	R134a	Voltage	12
Oil Type	ND-oil 8	Pulley Type	Magnetic Clutch
Oil Quantity	120	Diameter	110



GM		DCP20003	
Compressor Type	7SBU16C	Clutch Type	L50S
Refrigerant Type	R134a	Voltage	12
Oil Type	ND-oil 8	Pulley Type	Magnetic Clutch
Oil Quantity	120	Diameter	120



GM		DCP20006	
Compressor Type	7SBU16C	Clutch Type	L50S
Refrigerant Type	R134a	Voltage	12
Oil Type	ND-oil 8	Pulley Type	Magnetic Clutch
Oil Quantity	145	Diameter	120



GM		DCP20004	
Compressor Type	7SBU16C	Clutch Type	L50S
Refrigerant Type	R134a	Voltage	12
Oil Type	ND-oil 8	Pulley Type	Magnetic Clutch
Oil Quantity	120	Diameter	110



GM		DCP20021	
Compressor Type	5SL12C	Clutch Type	DL / B-PCW
Refrigerant Type	R134a	Voltage	
Oil Type	ND-oil 8	Pulley Type	DL-Pulley
Oil Quantity	80	Diameter	110



# A/C Components | Photo Guide - Compressors

GM		DCP20021K	
Compressor Type	5SL12C	Clutch Type	DL / B-PCW
Refrigerant Type	R134a	Voltage	
Oil Type	ND-oil 8	Pulley Type	DL-Pulley
Oil Quantity	40	Diameter	110



GM		DCP20030	
Compressor Type	7SBU16C	Clutch Type	L50S
Refrigerant Type	R134a	Voltage	12
Oil Type	ND-oil 8	Pulley Type	Magnetic Clutch
Oil Quantity	160	Diameter	110



GM		DCP20022	
Compressor Type	5SL12C	Clutch Type	DL / R-SC
Refrigerant Type	R134a	Voltage	
Oil Type	ND-oil 8	Pulley Type	DL-Pulley
Oil Quantity	80	Diameter	110



OPEL		DCP20120	
Compressor Type	5SL12C	Clutch Type	
Refrigerant Type	R134a; R12	Voltage	
Oil Type	ND-oil 12	Pulley Type	DL-Pulley
Oil Quantity	80	Diameter	110



GM		DCP20023	
Compressor Type	5SL12C	Clutch Type	DL / R-SC
Refrigerant Type	R134a	Voltage	
Oil Type	ND-oil 8	Pulley Type	DL-Pulley
Oil Quantity	80	Diameter	110



OPEL		DCP20121	
Compressor Type	5SL12C	Clutch Type	
Refrigerant Type	R134a; R12	Voltage	
Oil Type	ND-oil 12	Pulley Type	DL-Pulley
Oil Quantity	80	Diameter	110



OPEL		DCP20122	
Compressor Type	5SL12C	Clutch Type	
Refrigerant Type	R134a; R12	Voltage	
Oil Type	ND-oil 12	Pulley Type	DL-Pulley
Oil Quantity	80	Diameter	110

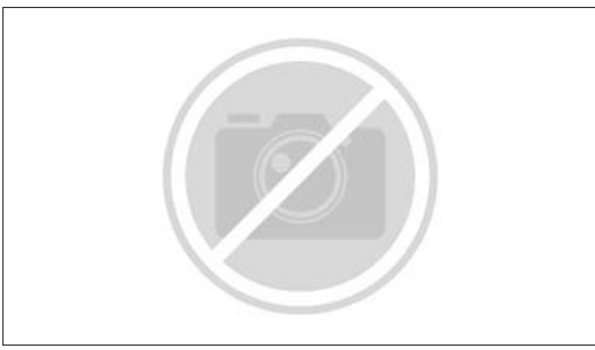

CITROEN-PEUGEOT		DCP21015	
Compressor Type	5SEL09C	Clutch Type	
Refrigerant Type	R134a	Voltage	
Oil Type	ND-oil 8	Pulley Type	DL-Pulley
Oil Quantity	80	Diameter	109



OPEL		DCP20123	
Compressor Type	5SL12C	Clutch Type	
Refrigerant Type	R134a; R12	Voltage	
Oil Type	ND-oil 12	Pulley Type	DL-Pulley
Oil Quantity	80	Diameter	110

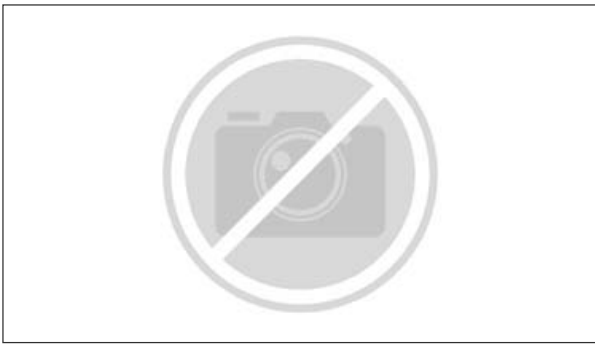

CITROEN-PEUGEOT		DCP21016	
Compressor Type	5SEL12C	Clutch Type	
Refrigerant Type	R1234yf	Voltage	
Oil Type	ND-Oil 12	Pulley Type	DL-Pulley
Oil Quantity	110	Diameter	108,6



CITROEN-PEUGEOT		DCP21014	
Compressor Type	6SEL16C	Clutch Type	DL / B-PC
Refrigerant Type	R134a	Voltage	
Oil Type	ND-oil 8	Pulley Type	DL-Pulley
Oil Quantity	110	Diameter	118.6



CITROEN-PEUGEOT		DCP21017	
Compressor Type	5SEL12C	Clutch Type	DL
Refrigerant Type	R1234yf	Voltage	
Oil Type	ND-Oil 12	Pulley Type	DL-Pulley
Oil Quantity	110	Diameter	118,6



CITROEN-PEUGEOT		DCP21021	
Compressor Type	5SEL12	Clutch Type	
Refrigerant Type	R134a; R12	Voltage	
Oil Type	ND-Oil 12	Pulley Type	DL-Pulley
Oil Quantity	110	Diameter	118,6



DENSO		DCP21024	
Compressor Type	5SEL12C	Clutch Type	
Refrigerant Type	R134a; R12	Voltage	
Oil Type	ND-oil 12	Pulley Type	DL-Pulley
Oil Quantity	110	Diameter	108,6



CITROEN-PEUGEOT		DCP21022	
Compressor Type	5SEL12	Clutch Type	
Refrigerant Type	R134a; R12	Voltage	
Oil Type	ND-Oil 12	Pulley Type	DL-Pulley
Oil Quantity	110	Diameter	108,6



PSA		DCP21025	
Compressor Type	5SEL09	Clutch Type	
Refrigerant Type	R134a; R12	Voltage	
Oil Type	ND-oil 12	Pulley Type	
Oil Quantity		Diameter	



DENSO		DCP21023	
Compressor Type	5SEL12C	Clutch Type	
Refrigerant Type	R134a; R12	Voltage	
Oil Type	ND-oil 12	Pulley Type	DL-Pulley
Oil Quantity	110	Diameter	118,6



RENAULT AGRICULTURE		DCP23002	
Compressor Type	SC08C	Clutch Type	CL / LS30
Refrigerant Type	R134a	Voltage	12
Oil Type	ND-oil 8	Pulley Type	Magnetic Clutch
Oil Quantity	80	Diameter	105



RENAULT		DCP23025	
Compressor Type	6SBU16C	Clutch Type	
Refrigerant Type	R134a	Voltage	12
Oil Type	ND-oil 8	Pulley Type	Magnetic Clutch
Oil Quantity	245	Diameter	120



RENAULT		DCP23032	
Compressor Type	6SEL14C	Clutch Type	B-PC
Refrigerant Type	R134a	Voltage	
Oil Type	ND-oil 8	Pulley Type	DL-Pulley
Oil Quantity	110	Diameter	115



RENAULT		DCP23030	
Compressor Type	6SEL14C	Clutch Type	B-PC
Refrigerant Type	R134a	Voltage	
Oil Type	ND-oil 8	Pulley Type	DL-Pulley
Oil Quantity	110	Diameter	125



RENAULT		DCP23034	
Compressor Type	6SBU16C	Clutch Type	LC45S
Refrigerant Type	R134a	Voltage	12
Oil Type	ND-oil 8	Pulley Type	Magnetic Clutch
Oil Quantity	110	Diameter	115



RENAULT		DCP23031	
Compressor Type	6SEL14C	Clutch Type	B-PC
Refrigerant Type	R134a	Voltage	
Oil Type	ND-oil 8	Pulley Type	DL-Pulley
Oil Quantity	110	Diameter	119



RENAULT		DCP23035	
Compressor Type	6SBL14C	Clutch Type	LC45S
Refrigerant Type	R134a	Voltage	12
Oil Type	ND-oil 8	Pulley Type	Magnetic Clutch
Oil Quantity	110	Diameter	125



RENAULT		DCP23530	
Compressor Type	10PA15C	Clutch Type	L50
Refrigerant Type	R134a	Voltage	12
Oil Type	ND-oil 8	Pulley Type	Magnetic Clutch
Oil Quantity	230	Diameter	119.6



RENAULT		DCP23537	
Compressor Type	10PA15C	Clutch Type	L50
Refrigerant Type	R134a	Voltage	12
Oil Type	ND-oil 8	Pulley Type	Magnetic Clutch
Oil Quantity	220	Diameter	119.6



RENAULT		DCP23531	
Compressor Type	10PA15C	Clutch Type	L50
Refrigerant Type	R134a	Voltage	12
Oil Type	ND-oil 8	Pulley Type	Magnetic Clutch
Oil Quantity	230	Diameter	119.6



RENAULT		DCP23538	
Compressor Type	10PA15C	Clutch Type	L50
Refrigerant Type	R134a	Voltage	12
Oil Type	ND-oil 8	Pulley Type	Magnetic Clutch
Oil Quantity	160	Diameter	130



RENAULT		DCP23535	
Compressor Type	10PA15C	Clutch Type	L50
Refrigerant Type	R134a	Voltage	12
Oil Type	ND-oil 8	Pulley Type	Magnetic Clutch
Oil Quantity	220	Diameter	130



CLAAS		DCP23539	
Compressor Type	10S15C	Clutch Type	
Refrigerant Type	R134a	Voltage	12
Oil Type	ND-oil 8	Pulley Type	Magnetic Clutch
Oil Quantity	200	Diameter	120





# A/C Components | Photo Guide - Compressors

CLAAS		DCP23540	
Compressor Type	10S15C	Clutch Type	
Refrigerant Type	R134a	Voltage	12
Oil Type	ND-oil 8	Pulley Type	Magnetic Clutch
Oil Quantity	200	Diameter	140



ROVER		DCP24004	
Compressor Type	7SBU16C	Clutch Type	L50S
Refrigerant Type	R134a	Voltage	12
Oil Type	ND-oil 8	Pulley Type	Magnetic Clutch
Oil Quantity	120	Diameter	120



CLAAS		DCP23541	
Compressor Type	10S15C	Clutch Type	
Refrigerant Type	R134a	Voltage	12
Oil Type	ND-oil 8	Pulley Type	Magnetic Clutch
Oil Quantity	200	Diameter	120



ROVER		DCP24005	
Compressor Type	7SBU16C	Clutch Type	L50S
Refrigerant Type	R134a	Voltage	12
Oil Type	ND-oil 8	Pulley Type	Magnetic Clutch
Oil Quantity	120	Diameter	120



ROVER		DCP24001	
Compressor Type	6CA17A	Clutch Type	CL / L50CA
Refrigerant Type	R134a	Voltage	12
Oil Type	ND-oil 8	Pulley Type	Magnetic Clutch
Oil Quantity	155	Diameter	125



SAAB		DCP25001	
Compressor Type	7SBU16C	Clutch Type	L50S
Refrigerant Type	R134a	Voltage	12
Oil Type	ND-oil 8	Pulley Type	Magnetic Clutch
Oil Quantity	145	Diameter	120



VW-Group		DCP27001	
Compressor Type	6SEU12C	Clutch Type	DL / R-SC
Refrigerant Type	R134a	Voltage	
Oil Type	ND-oil 8	Pulley Type	DL-Pulley
Oil Quantity	140	Diameter	110



PORSCHE		DCP28003	
Compressor Type	10PA15C	Clutch Type	L
Refrigerant Type	R12 (Retrof)	Voltage	12
Oil Type	ND-oil 6	Pulley Type	Magnetic Clutch
Oil Quantity	100	Diameter	121.5



VW-Group		DCP27002	
Compressor Type	6SEU12C	Clutch Type	DL / R-SC
Refrigerant Type	R134a	Voltage	
Oil Type	ND-oil 8	Pulley Type	DL-Pulley
Oil Quantity	140	Diameter	110



PORSCHE		DCP28004	
Compressor Type	10PA15C	Clutch Type	L50
Refrigerant Type	R134a	Voltage	12
Oil Type	ND-oil 8	Pulley Type	Magnetic Clutch
Oil Quantity	135	Diameter	125



PORSCHE		DCP28001	
Compressor Type	10P15E	Clutch Type	P
Refrigerant Type	R12 (Retrof)	Voltage	12
Oil Type	ND-oil 6	Pulley Type	Magnetic Clutch
Oil Quantity	80	Diameter	124.8



PORSCHE		DCP28006	
Compressor Type	10PA20C	Clutch Type	L50
Refrigerant Type	R134a	Voltage	12
Oil Type	ND-oil 8	Pulley Type	Magnetic Clutch
Oil Quantity	165	Diameter	130



# A/C Components

## Photo Guide - Compressors

PORSCHE		DCP28008	
Compressor Type	7SBU16C	Clutch Type	L50S
Refrigerant Type	R134a	Voltage	12
Oil Type	ND-oil 8	Pulley Type	Magnetic Clutch
Oil Quantity	195	Diameter	120



PORSCHE		DCP28014	
Compressor Type	7SEU17C	Clutch Type	
Refrigerant Type	R134a	Voltage	
Oil Type	ND-oil 8	Pulley Type	DL-Pulley
Oil Quantity	110	Diameter	120



PORSCHE		DCP28010	
Compressor Type	7SEU17C	Clutch Type	DL / R-SC
Refrigerant Type	R134a	Voltage	
Oil Type	ND-oil 8	Pulley Type	DL-Pulley
Oil Quantity	140	Diameter	120



PORSCHE		DCP28016	
Compressor Type	7SEU17C	Clutch Type	
Refrigerant Type	R134a	Voltage	
Oil Type	ND-oil 8	Pulley Type	DL-Pulley
Oil Quantity	150	Diameter	120



PORSCHE		DCP28012	
Compressor Type	7SEU17C	Clutch Type	B-PC
Refrigerant Type	R134a	Voltage	
Oil Type	ND-oil 8	Pulley Type	DL-Pulley
Oil Quantity	150	Diameter	120



PORSCHE		DCP28017	
Compressor Type	7SEU17C	Clutch Type	
Refrigerant Type	R134a	Voltage	
Oil Type	ND-oil 8	Pulley Type	DL-Pulley
Oil Quantity	110	Diameter	120



# A/C Components | Photo Guide - Compressors

PORSCHE		DCP28018	
Compressor Type	6SES14C	Clutch Type	DL
Refrigerant Type	R134a	Voltage	
Oil Type	ND-Oil 8	Pulley Type	DL-Pulley
Oil Quantity	110	Diameter	120



VW-Group		DCP32002	
Compressor Type	7SEU17C	Clutch Type	DL / R-SC
Refrigerant Type	R134a	Voltage	
Oil Type	ND-oil 8	Pulley Type	DL-Pulley
Oil Quantity	180	Diameter	110



PORSCHE		DCP28019	
Compressor Type	7SEU17C	Clutch Type	
Refrigerant Type	R134a; R12	Voltage	
Oil Type	ND-oil 12	Pulley Type	DL-Pulley
Oil Quantity	160	Diameter	120



VW-Group		DCP32003	
Compressor Type	7SEU16C	Clutch Type	DL / R-SC
Refrigerant Type	R134a	Voltage	
Oil Type	ND-oil 8	Pulley Type	DL-Pulley
Oil Quantity	180	Diameter	110



VW-Group		DCP32001	
Compressor Type	7SBU16C	Clutch Type	L50S
Refrigerant Type	R134a	Voltage	12
Oil Type	ND-oil 8	Pulley Type	Magnetic Clutch
Oil Quantity	245	Diameter	120



VW-Group		DCP32005	
Compressor Type	6SEU14C	Clutch Type	DL / B-PC
Refrigerant Type	R134a	Voltage	
Oil Type	ND-oil 8	Pulley Type	DL-Pulley
Oil Quantity	80	Diameter	110



# A/C Components

## Photo Guide - Compressors

VW-Group		DCP32006	
Compressor Type	7SEU17C	Clutch Type	Direct-Drive
Refrigerant Type	R134a	Voltage	
Oil Type	ND-oil 8	Pulley Type	DL-Pulley
Oil Quantity	140	Diameter	



VW-Group		DCP32021	
Compressor Type	7SEU17C	Clutch Type	DL / B-PC
Refrigerant Type	R134a	Voltage	
Oil Type	ND-oil 8	Pulley Type	DL-Pulley
Oil Quantity	180	Diameter	100



VW-Group		DCP32006K	
Compressor Type	7SEU17C	Clutch Type	Direct-Drive
Refrigerant Type	R134a	Voltage	
Oil Type	ND-oil 8	Pulley Type	DL-Pulley
Oil Quantity	140	Diameter	



VW-Group		DCP32022	
Compressor Type	7SEU17C	Clutch Type	DL / B-PC
Refrigerant Type	R134a	Voltage	
Oil Type	ND-oil 8	Pulley Type	DL-Pulley
Oil Quantity	140	Diameter	110



VW-Group		DCP32020	
Compressor Type	6SEU14C	Clutch Type	DL / B-PC
Refrigerant Type	R134a	Voltage	
Oil Type	ND-oil 8	Pulley Type	DL-Pulley
Oil Quantity	80	Diameter	110



VW-Group		DCP32023	
Compressor Type	7SEU16C	Clutch Type	DL / R-SC
Refrigerant Type	R134a	Voltage	
Oil Type	ND-oil 8	Pulley Type	DL-Pulley
Oil Quantity	200	Diameter	120



# A/C Components | Photo Guide - Compressors

VW-Group		DCP32031	
Compressor Type	7SEU17C	Clutch Type	DL / R-SC
Refrigerant Type	R134a	Voltage	
Oil Type	ND-oil 8	Pulley Type	DL-Pulley
Oil Quantity	140	Diameter	110



VW-Group		DCP32051	
Compressor Type	7SEU17C	Clutch Type	
Refrigerant Type	R134a	Voltage	
Oil Type	ND-oil 8	Pulley Type	DL-Pulley
Oil Quantity	140	Diameter	120



VW-Group		DCP32045	
Compressor Type	7SEU17C	Clutch Type	DL / B-PC
Refrigerant Type	R134a	Voltage	
Oil Type	ND-oil 8	Pulley Type	DL-Pulley
Oil Quantity	140	Diameter	110



VW-Group		DCP32052	
Compressor Type	7SEU16C	Clutch Type	DL
Refrigerant Type	R134a	Voltage	
Oil Type	ND-oil 8	Pulley Type	DL-Pulley
Oil Quantity	200	Diameter	110



VW-Group		DCP32050	
Compressor Type	7SEU17C	Clutch Type	
Refrigerant Type	R134a	Voltage	
Oil Type	ND-oil 8	Pulley Type	DL-Pulley
Oil Quantity	140	Diameter	100



VW-Group		DCP32055	
Compressor Type	7SEU17C	Clutch Type	
Refrigerant Type	R134a	Voltage	
Oil Type	ND-oil 8	Pulley Type	DL-Pulley
Oil Quantity	160	Diameter	110



# A/C Components

## Photo Guide - Compressors

VW-Group		DCP32056	
Compressor Type	6SEU14C	Clutch Type	DL / B-PC
Refrigerant Type	R134a	Voltage	
Oil Type	ND-oil 8	Pulley Type	DL-Pulley
Oil Quantity	90	Diameter	110



VW-Group		DCP32062	
Compressor Type	6SEU14C	Clutch Type	
Refrigerant Type	R134a	Voltage	
Oil Type	ND-oil 8	Pulley Type	DL-Pulley
Oil Quantity	130	Diameter	



VW-Group		DCP32060	
Compressor Type	6SES14C	Clutch Type	DL
Refrigerant Type	R134a	Voltage	
Oil Type	ND-oil 8	Pulley Type	DL-Pulley
Oil Quantity	110	Diameter	110



VW-Group		DCP32063	
Compressor Type	7SEU17C	Clutch Type	
Refrigerant Type	R134a	Voltage	
Oil Type	ND-oil 8	Pulley Type	DL-Pulley
Oil Quantity	140	Diameter	100



VW-Group		DCP32061	
Compressor Type	6SEU14C	Clutch Type	
Refrigerant Type	R134a	Voltage	
Oil Type	ND-oil 8	Pulley Type	DL-Pulley
Oil Quantity	150	Diameter	110



VW-Group		DCP32064	
Compressor Type	7SEU17C	Clutch Type	
Refrigerant Type	R134a	Voltage	
Oil Type	ND-oil 8	Pulley Type	DL-Pulley
Oil Quantity	160	Diameter	125



# A/C Components | Photo Guide - Compressors

VW-Group		DCP32065	
Compressor Type	6SES14C	Clutch Type	
Refrigerant Type	R134a	Voltage	
Oil Type	ND-oil 8	Pulley Type	DL-Pulley
Oil Quantity	140	Diameter	100



VW-Group		DCP32068	
Compressor Type	7SEU17C	Clutch Type	
Refrigerant Type	R134a	Voltage	
Oil Type	ND-oil 8	Pulley Type	DL-Pulley
Oil Quantity	150	Diameter	100



VW-Group		DCP32066	
Compressor Type	6SEU14C	Clutch Type	
Refrigerant Type	R134a	Voltage	
Oil Type	ND-oil 8	Pulley Type	DL-Pulley
Oil Quantity	140	Diameter	100



VW-Group		DCP32069	
Compressor Type	6SEU14C	Clutch Type	
Refrigerant Type	R134a	Voltage	
Oil Type	ND-oil 8	Pulley Type	DL-Pulley
Oil Quantity	140	Diameter	100



VW-Group		DCP32067	
Compressor Type	10S17C	Clutch Type	L50T
Refrigerant Type	R134a	Voltage	12
Oil Type	ND-oil 8	Pulley Type	Magnetic Clutch
Oil Quantity	160	Diameter	120



VW-Group		DCP32070	
Compressor Type	7SEU17C	Clutch Type	
Refrigerant Type	R134a	Voltage	
Oil Type	ND-oil 8	Pulley Type	DL-Pulley
Oil Quantity	140	Diameter	100







# A/C Components

## Photo Guide - Compressors

VW-Group		DCP32071	
Compressor Type	6SEU14C	Clutch Type	
Refrigerant Type	R134a	Voltage	
Oil Type	ND-oil 8	Pulley Type	DL-Pulley
Oil Quantity	130	Diameter	100



VW-Group		DCP32074	
Compressor Type	6SES14C	Clutch Type	
Refrigerant Type	R134a	Voltage	
Oil Type	ND-oil 8	Pulley Type	DL-Pulley
Oil Quantity	140	Diameter	110



VW-Group		DCP32072	
Compressor Type	7SEU17C	Clutch Type	
Refrigerant Type	R134a	Voltage	
Oil Type	ND-oil 8	Pulley Type	DL-Pulley
Oil Quantity	140	Diameter	100



VW-Group		DCP32075	
Compressor Type	7SEU17C	Clutch Type	
Refrigerant Type	R134a; R12	Voltage	
Oil Type	ND-oil 12	Pulley Type	DL-Pulley
Oil Quantity	170	Diameter	100



VW-Group		DCP32073	
Compressor Type	7SEU17C	Clutch Type	
Refrigerant Type	R134a	Voltage	
Oil Type	ND-oil 8	Pulley Type	DL-Pulley
Oil Quantity	170	Diameter	100



VW-Group		DCP32076	
Compressor Type	7SEU17C	Clutch Type	
Refrigerant Type	R134a; R12	Voltage	
Oil Type	ND-oil 12	Pulley Type	DL-Pulley
Oil Quantity	250	Diameter	100



# A/C Components | Photo Guide - Compressors

VW-Group		DCP32077	
Compressor Type	6SEU14C	Clutch Type	
Refrigerant Type	R134a	Voltage	
Oil Type	ND-oil 8	Pulley Type	DL-Pulley
Oil Quantity	170	Diameter	100



SUBARU		DCP36002	
Compressor Type	SCSA08C	Clutch Type	
Refrigerant Type	R134a	Voltage	12
Oil Type	ND-oil 8	Pulley Type	Magnetic Clutch
Oil Quantity	70	Diameter	93



VW-Group		DCP32080	
Compressor Type	6SES14C	Clutch Type	
Refrigerant Type	R134a; R12	Voltage	
Oil Type	ND-oil 12	Pulley Type	DL-Pulley
Oil Quantity	110	Diameter	110



SUBARU		DCP36003	
Compressor Type	SCSA08C	Clutch Type	
Refrigerant Type	R134a	Voltage	12
Oil Type	ND-oil 8	Pulley Type	Magnetic Clutch
Oil Quantity	70	Diameter	93



SUBARU		DCP36001	
Compressor Type	SCSA08C	Clutch Type	
Refrigerant Type	R134a	Voltage	12
Oil Type	ND-oil 8	Pulley Type	Magnetic Clutch
Oil Quantity	70	Diameter	93



SUBARU		DCP36004	
Compressor Type	10S15L	Clutch Type	
Refrigerant Type	R134a	Voltage	12
Oil Type	ND-oil 8	Pulley Type	Magnetic Clutch
Oil Quantity	120	Diameter	110



# A/C Components

## Photo Guide - Compressors

SUBARU		DCP36005	
Compressor Type	TV14C	Clutch Type	L50
Refrigerant Type	R134a	Voltage	12
Oil Type	ND-oil 8	Pulley Type	Magnetic Clutch
Oil Quantity	150	Diameter	120



HONDA		DCP40002	
Compressor Type	10S17C	Clutch Type	
Refrigerant Type	R134a	Voltage	
Oil Type	ND-oil 8	Pulley Type	DL-Pulley
Oil Quantity	160	Diameter	150

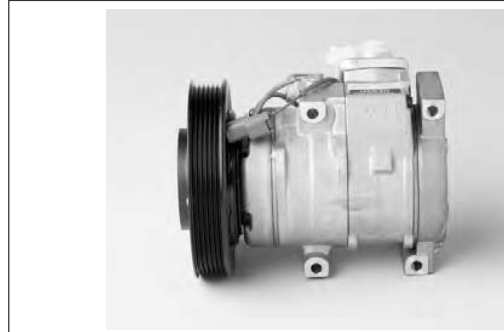

SUBARU		DCP36006	
Compressor Type	TV12C	Clutch Type	L50
Refrigerant Type	R134a	Voltage	12
Oil Type	ND-oil 8	Pulley Type	Magnetic Clutch
Oil Quantity	150	Diameter	120



HONDA		DCP40003	
Compressor Type	10S17C	Clutch Type	
Refrigerant Type	R134a	Voltage	12
Oil Type	ND-oil 8	Pulley Type	Magnetic Clutch
Oil Quantity	160	Diameter	115



SUBARU		DCP36007	
Compressor Type	10SR17C	Clutch Type	
Refrigerant Type	R134a	Voltage	
Oil Type	ND-oil 8	Pulley Type	DL-Pulley
Oil Quantity	145	Diameter	115



HONDA		DCP40004	
Compressor Type	10SR15C	Clutch Type	
Refrigerant Type	R134a	Voltage	12
Oil Type	ND-oil 8	Pulley Type	Magnetic Clutch
Oil Quantity	105	Diameter	115

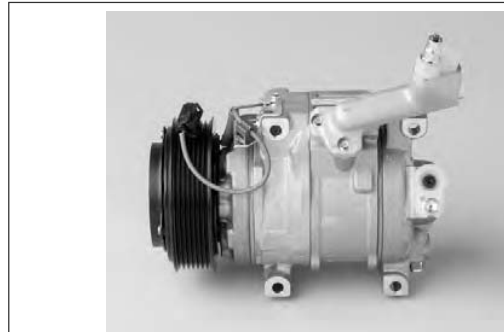

# A/C Components | Photo Guide - Compressors

HONDA		DCP40012	
Compressor Type	10S17C	Clutch Type	LC45
Refrigerant Type	R134a	Voltage	12
Oil Type	ND-oil 8	Pulley Type	Magnetic Clutch
Oil Quantity	160	Diameter	130



HONDA		DCP40018	
Compressor Type	10SR15C	Clutch Type	
Refrigerant Type	R134a	Voltage	
Oil Type	ND-oil 8	Pulley Type	
Oil Quantity		Diameter	



HONDA		DCP40015	
Compressor Type	10S17C	Clutch Type	
Refrigerant Type	R134a	Voltage	12
Oil Type	ND-oil 8	Pulley Type	Magnetic Clutch
Oil Quantity	100	Diameter	120



MAZDA		DCP44010	
Compressor Type	SCSA06C	Clutch Type	
Refrigerant Type	R134a	Voltage	12
Oil Type	ND-oil 8	Pulley Type	Magnetic Clutch
Oil Quantity	60	Diameter	93



HONDA		DCP40017	
Compressor Type	10SR15C	Clutch Type	
Refrigerant Type	R134a	Voltage	
Oil Type	ND-oil 8	Pulley Type	
Oil Quantity		Diameter	



MITSUBISHI		DCP45003	
Compressor Type	5SE09C	Clutch Type	DL
Refrigerant Type	R134a	Voltage	
Oil Type	ND-oil 8	Pulley Type	DL-Pulley
Oil Quantity	80	Diameter	100



# A/C Components | Photo Guide - Compressors

MITSUBISHI		DCP45004	
Compressor Type	10S17C	Clutch Type	LC45
Refrigerant Type	R134a	Voltage	12
Oil Type	ND-oil 8	Pulley Type	Magnetic Clutch
Oil Quantity	120	Diameter	130



MITSUBISHI		DCP45008	
Compressor Type	-	Clutch Type	
Refrigerant Type	R134a	Voltage	
Oil Type	ND-oil 8	Pulley Type	DL-Pulley
Oil Quantity	140	Diameter	



MITSUBISHI		DCP45005	
Compressor Type	10S17C	Clutch Type	LC45
Refrigerant Type	R134a	Voltage	12
Oil Type	ND-oil 8	Pulley Type	Magnetic Clutch
Oil Quantity	180	Diameter	130



MITSUBISHI		DCP45009	
Compressor Type	10S17C	Clutch Type	
Refrigerant Type	R134a	Voltage	12
Oil Type	ND-oil 8	Pulley Type	Magnetic Clutch
Oil Quantity	120	Diameter	130



MITSUBISHI		DCP45006	
Compressor Type	10S17C	Clutch Type	LC45
Refrigerant Type	R134a	Voltage	12
Oil Type	ND-oil 8	Pulley Type	Magnetic Clutch
Oil Quantity	120	Diameter	120



MITSUBISHI		DCP45010	
Compressor Type	10PA15VC	Clutch Type	L50
Refrigerant Type	R134a	Voltage	12
Oil Type	ND-oil 8	Pulley Type	Magnetic Clutch
Oil Quantity	120	Diameter	130



# A/C Components | Photo Guide - Compressors

MITSUBISHI		DCP45011	
Compressor Type	10S17C	Clutch Type	
Refrigerant Type	R134a	Voltage	12
Oil Type	ND-oil 8	Pulley Type	Magnetic Clutch
Oil Quantity	140	Diameter	120

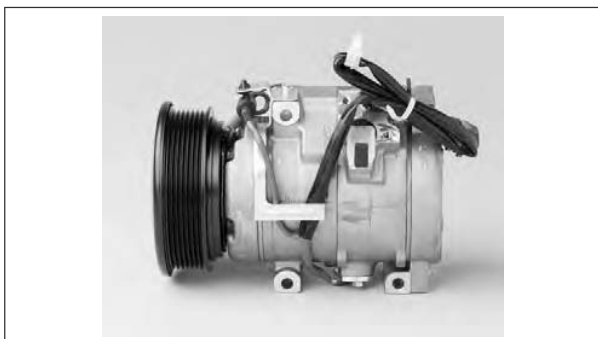

MITSUBISHI		DCP45014	
Compressor Type	10S17C	Clutch Type	L50T
Refrigerant Type	R134a	Voltage	12
Oil Type	ND-oil 8	Pulley Type	Magnetic Clutch
Oil Quantity	140	Diameter	140



MITSUBISHI		DCP45012	
Compressor Type	10S17C	Clutch Type	L50T
Refrigerant Type	R134a	Voltage	12
Oil Type	ND-oil 8	Pulley Type	Magnetic Clutch
Oil Quantity	120	Diameter	140



NISSAN		DCP46020	
Compressor Type	6SBH14C	Clutch Type	
Refrigerant Type	R1234yf	Voltage	12
Oil Type	ND-Oil 12	Pulley Type	Magnetic Clutch
Oil Quantity	110	Diameter	115



MITSUBISHI		DCP45013	
Compressor Type	10S17C	Clutch Type	
Refrigerant Type	R134a	Voltage	12
Oil Type	ND-oil 8	Pulley Type	Magnetic Clutch
Oil Quantity	180	Diameter	120



NISSAN		DCP46021	
Compressor Type	6SBH14C	Clutch Type	
Refrigerant Type	R1234yf	Voltage	12
Oil Type	ND-Oil 12	Pulley Type	Magnetic Clutch
Oil Quantity	110	Diameter	115



# A/C Components | Photo Guide - Compressors

NISSAN		DCP46022	
Compressor Type	6SBH14C	Clutch Type	
Refrigerant Type	R1234yf	Voltage	12
Oil Type	ND-Oil 12	Pulley Type	Magnetic Clutch
Oil Quantity	110	Diameter	125



SUZUKI		DCP47001	
Compressor Type	10S11C	Clutch Type	LS30S
Refrigerant Type	R134a	Voltage	12
Oil Type	ND-oil 8	Pulley Type	Magnetic Clutch
Oil Quantity	100	Diameter	115



NISSAN		DCP46024	
Compressor Type	6SBH14C	Clutch Type	
Refrigerant Type	R134a; R12	Voltage	12
Oil Type	ND-oil 12	Pulley Type	Magnetic Clutch
Oil Quantity	110	Diameter	115



SUZUKI		DCP47002	
Compressor Type	SV06E	Clutch Type	
Refrigerant Type	R134a	Voltage	12
Oil Type	ND-oil 8	Pulley Type	Magnetic Clutch
Oil Quantity	110	Diameter	93



NISSAN		DCP46025	
Compressor Type	6SBH14C	Clutch Type	
Refrigerant Type	R134a; R12	Voltage	12
Oil Type	ND-oil 12	Pulley Type	Magnetic Clutch
Oil Quantity	110	Diameter	115



SUZUKI		DCP47003	
Compressor Type	10S13C	Clutch Type	
Refrigerant Type	R134a	Voltage	12
Oil Type	ND-oil 8	Pulley Type	Magnetic Clutch
Oil Quantity	100	Diameter	110



# A/C Components | Photo Guide - Compressors

SUZUKI		DCP47004	
Compressor Type	10S13C	Clutch Type	
Refrigerant Type	R134a	Voltage	12
Oil Type	ND-oil 8	Pulley Type	Magnetic Clutch
Oil Quantity	140	Diameter	110



SUZUKI		DCP47008	
Compressor Type	10P08E	Clutch Type	
Refrigerant Type	R134a	Voltage	12
Oil Type	ND-oil 8	Pulley Type	Magnetic Clutch
Oil Quantity	100	Diameter	100



SUZUKI		DCP47006	
Compressor Type	10S11C	Clutch Type	
Refrigerant Type	R134a	Voltage	
Oil Type	ND-oil 8	Pulley Type	DL-Pulley
Oil Quantity	105	Diameter	105



SUZUKI		DCP47009	
Compressor Type	5SL12C	Clutch Type	
Refrigerant Type	R134a; R12	Voltage	
Oil Type	ND-oil 12	Pulley Type	
Oil Quantity	80	Diameter	



SUZUKI		DCP47007	
Compressor Type	SS10	Clutch Type	
Refrigerant Type	R134a	Voltage	12
Oil Type		Pulley Type	Magnetic Clutch
Oil Quantity		Diameter	



SUZUKI		DCP47010	
Compressor Type	5SL12C	Clutch Type	
Refrigerant Type	R134a; R12	Voltage	
Oil Type	ND-oil 12	Pulley Type	
Oil Quantity	80	Diameter	





# A/C Components

## Photo Guide - Compressors

SUZUKI		DCP47011	
Compressor Type	10SRE13C	Clutch Type	
Refrigerant Type	R134a; R12	Voltage	12
Oil Type	ND-oil 12	Pulley Type	Magnetic Clutch
Oil Quantity	70	Diameter	100

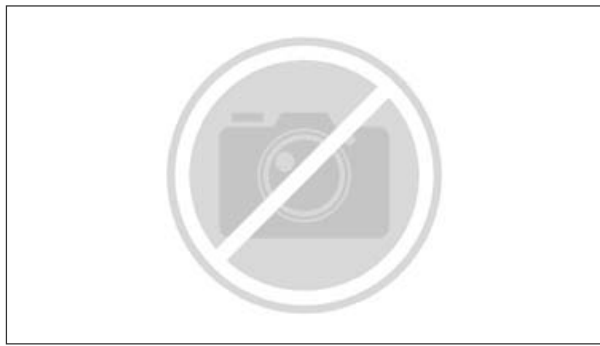

DAIHATSU		DCP49001	
Compressor Type	SV07C	Clutch Type	
Refrigerant Type	R134a	Voltage	12
Oil Type	ND-oil 8	Pulley Type	Magnetic Clutch
Oil Quantity	80	Diameter	93



SUZUKI		DCP47012	
Compressor Type	10SRE13C	Clutch Type	
Refrigerant Type	R134a; R12	Voltage	12
Oil Type	ND-oil 12	Pulley Type	Magnetic Clutch
Oil Quantity	70	Diameter	100



DAIHATSU		DCP49002	
Compressor Type	SCA06E	Clutch Type	K20S
Refrigerant Type	R134a	Voltage	12
Oil Type	ND-oil 8	Pulley Type	Magnetic Clutch
Oil Quantity	65	Diameter	105



SUZUKI		DCP47013	
Compressor Type	10SRE13C	Clutch Type	
Refrigerant Type	R134a; R12	Voltage	12
Oil Type	ND-oil 12	Pulley Type	Magnetic Clutch
Oil Quantity	70	Diameter	100

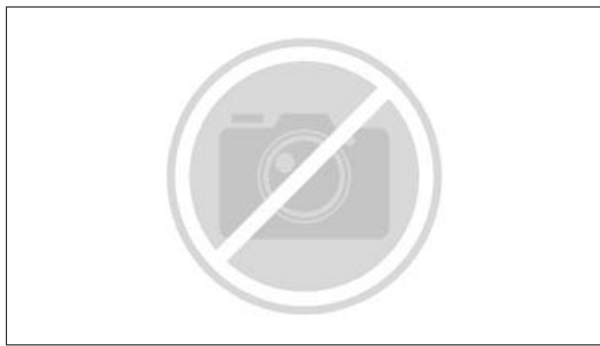

TOYOTA		DCP50001	
Compressor Type	5SE09C	Clutch Type	DL
Refrigerant Type	R134a	Voltage	
Oil Type	ND-oil 8	Pulley Type	DL-Pulley
Oil Quantity	60	Diameter	115



TOYOTA		DCP50002	
Compressor Type	SCSA06C	Clutch Type	LC20
Refrigerant Type	R134a	Voltage	12
Oil Type	ND-oil 8	Pulley Type	Magnetic Clutch
Oil Quantity	60	Diameter	105



TOYOTA		DCP50005	
Compressor Type	SCSA06C	Clutch Type	LS20
Refrigerant Type	R134a	Voltage	12
Oil Type	ND-oil 8	Pulley Type	Magnetic Clutch
Oil Quantity	60	Diameter	115



TOYOTA		DCP50003	
Compressor Type	SCSA06C	Clutch Type	LC20
Refrigerant Type	R134a	Voltage	12
Oil Type	ND-oil 8	Pulley Type	Magnetic Clutch
Oil Quantity	60	Diameter	105



TOYOTA		DCP50006	
Compressor Type	SCSA06C	Clutch Type	LC20
Refrigerant Type	R134a	Voltage	12
Oil Type	ND-oil 8	Pulley Type	Magnetic Clutch
Oil Quantity	60	Diameter	115



TOYOTA		DCP50004	
Compressor Type	SCSA06C	Clutch Type	LS20
Refrigerant Type	R134a	Voltage	12
Oil Type	ND-oil 8	Pulley Type	Magnetic Clutch
Oil Quantity	60	Diameter	120



TOYOTA		DCP50007	
Compressor Type	SCSA06C	Clutch Type	LC20
Refrigerant Type	R134a	Voltage	12
Oil Type	ND-oil 8	Pulley Type	Magnetic Clutch
Oil Quantity	60	Diameter	110



# A/C Components | Photo Guide - Compressors

TOYOTA		DCP50009	
Compressor Type	5SE09C	Clutch Type	DL
Refrigerant Type	R134a	Voltage	
Oil Type	ND-oil 8	Pulley Type	DL-Pulley
Oil Quantity	60	Diameter	115



TOYOTA		DCP50012	
Compressor Type	SCSA06C	Clutch Type	LC20
Refrigerant Type	R134a	Voltage	12
Oil Type	ND-oil 8	Pulley Type	Magnetic Clutch
Oil Quantity	60	Diameter	93



TOYOTA		DCP50010	
Compressor Type	SCSA06C	Clutch Type	LC20
Refrigerant Type	R134a	Voltage	12
Oil Type	ND-oil 8	Pulley Type	Magnetic Clutch
Oil Quantity	60	Diameter	120



TOYOTA		DCP50013	
Compressor Type	SCSA06C	Clutch Type	LC20
Refrigerant Type	R134a	Voltage	12
Oil Type	ND-oil 8	Pulley Type	Magnetic Clutch
Oil Quantity	60	Diameter	100



TOYOTA		DCP50011	
Compressor Type	SCSA06C	Clutch Type	LC20
Refrigerant Type	R134a	Voltage	12
Oil Type	ND-oil 8	Pulley Type	Magnetic Clutch
Oil Quantity	60	Diameter	93



TOYOTA		DCP50014	
Compressor Type	SCS06C	Clutch Type	
Refrigerant Type	R134a	Voltage	12
Oil Type	ND-oil 8	Pulley Type	Magnetic Clutch
Oil Quantity	80	Diameter	100



# A/C Components | Photo Guide - Compressors

TOYOTA		DCP50015	
Compressor Type	SCSA06C	Clutch Type	LS20
Refrigerant Type	R134a	Voltage	12
Oil Type	ND-oil 8	Pulley Type	Magnetic Clutch
Oil Quantity	60	Diameter	93



TOYOTA		DCP50022	
Compressor Type	10S15C	Clutch Type	LS45
Refrigerant Type	R134a	Voltage	12
Oil Type	ND-oil 8	Pulley Type	Magnetic Clutch
Oil Quantity	140	Diameter	150



TOYOTA		DCP50020	
Compressor Type	10S15L	Clutch Type	LS45
Refrigerant Type	R134a	Voltage	12
Oil Type	ND-oil 8	Pulley Type	Magnetic Clutch
Oil Quantity	140	Diameter	140



TOYOTA		DCP50023	
Compressor Type	10PA15L	Clutch Type	L50
Refrigerant Type	R134a	Voltage	12
Oil Type	ND-oil 8	Pulley Type	Magnetic Clutch
Oil Quantity	140	Diameter	150



TOYOTA		DCP50021	
Compressor Type	10PA15C	Clutch Type	L50
Refrigerant Type	R134a	Voltage	12
Oil Type	ND-oil 8	Pulley Type	Magnetic Clutch
Oil Quantity	140	Diameter	140



TOYOTA		DCP50024	
Compressor Type	10PA15L	Clutch Type	L50
Refrigerant Type	R134a	Voltage	12
Oil Type	ND-oil 8	Pulley Type	Magnetic Clutch
Oil Quantity	140	Diameter	135



# A/C Components | Photo Guide - Compressors

TOYOTA		DCP50025	
Compressor Type	10PA15L	Clutch Type	L50
Refrigerant Type	R134a	Voltage	12
Oil Type	ND-oil 8	Pulley Type	Magnetic Clutch
Oil Quantity	140	Diameter	120



TOYOTA		DCP50031	
Compressor Type	10PA15L	Clutch Type	L50
Refrigerant Type	R134a	Voltage	12
Oil Type	ND-oil 8	Pulley Type	Magnetic Clutch
Oil Quantity	120	Diameter	120



TOYOTA		DCP50026	
Compressor Type	10S15L	Clutch Type	L50
Refrigerant Type	R134a	Voltage	12
Oil Type	ND-oil 8	Pulley Type	Magnetic Clutch
Oil Quantity	140	Diameter	120



TOYOTA		DCP50032	
Compressor Type	10S15L	Clutch Type	LC45
Refrigerant Type	R134a	Voltage	12
Oil Type	ND-oil 8	Pulley Type	Magnetic Clutch
Oil Quantity	100	Diameter	120



TOYOTA		DCP50030	
Compressor Type	10S15L	Clutch Type	LC45
Refrigerant Type	R134a	Voltage	12
Oil Type	ND-oil 8	Pulley Type	Magnetic Clutch
Oil Quantity	100	Diameter	140



TOYOTA		DCP50033	
Compressor Type	10S15C	Clutch Type	LC45
Refrigerant Type	R134a	Voltage	12
Oil Type	ND-oil 8	Pulley Type	Magnetic Clutch
Oil Quantity	100	Diameter	130



# A/C Components | Photo Guide - Compressors

TOYOTA		DCP50035	
Compressor Type	5SE12C	Clutch Type	
Refrigerant Type	R134a	Voltage	
Oil Type	ND-oil 8	Pulley Type	DL-Pulley
Oil Quantity	90	Diameter	120



TOYOTA		DCP50039	
Compressor Type	6SEU16C	Clutch Type	
Refrigerant Type	R134a	Voltage	
Oil Type	ND-oil 8	Pulley Type	DL-Pulley
Oil Quantity	130	Diameter	110



TOYOTA		DCP50036	
Compressor Type	6SEU14C	Clutch Type	DL
Refrigerant Type	R134a	Voltage	
Oil Type	ND-Oil 8	Pulley Type	DL-Pulley
Oil Quantity	90	Diameter	120



TOYOTA		DCP50040	
Compressor Type	10S17C	Clutch Type	LS45
Refrigerant Type	R134a	Voltage	12
Oil Type	ND-oil 8	Pulley Type	Magnetic Clutch
Oil Quantity	120	Diameter	130



TOYOTA		DCP50037	
Compressor Type	6SEU14C	Clutch Type	DL
Refrigerant Type	R134a	Voltage	
Oil Type	ND-Oil 8	Pulley Type	DL-Pulley
Oil Quantity	90	Diameter	120



TOYOTA		DCP50041	
Compressor Type	10S17C	Clutch Type	LC45
Refrigerant Type	R134a	Voltage	12
Oil Type	ND-oil 8	Pulley Type	Magnetic Clutch
Oil Quantity	120	Diameter	130



# A/C Components | Photo Guide - Compressors

TOYOTA		DCP50042	
Compressor Type	6SEU16C	Clutch Type	B-SD
Refrigerant Type	R134a	Voltage	
Oil Type	ND-oil 8	Pulley Type	DL-Pulley
Oil Quantity	130	Diameter	110



TOYOTA		DCP50070	
Compressor Type	10PA15C	Clutch Type	L50
Refrigerant Type	R12 (Retrof)	Voltage	12
Oil Type	ND-oil 6	Pulley Type	Magnetic Clutch
Oil Quantity	100	Diameter	135



TOYOTA		DCP50050	
Compressor Type	10PA15C	Clutch Type	L50
Refrigerant Type	R134a	Voltage	12
Oil Type	ND-oil 8	Pulley Type	Magnetic Clutch
Oil Quantity	120	Diameter	135



TOYOTA		DCP50071	
Compressor Type	10PA15L	Clutch Type	
Refrigerant Type	R134a	Voltage	12
Oil Type	ND-oil 8	Pulley Type	Magnetic Clutch
Oil Quantity	120	Diameter	140



TOYOTA		DCP50060	
Compressor Type	10S15L	Clutch Type	LS45
Refrigerant Type	R134a	Voltage	12
Oil Type	ND-oil 8	Pulley Type	Magnetic Clutch
Oil Quantity	100	Diameter	140



TOYOTA		DCP50073	
Compressor Type	10PA15L	Clutch Type	L50
Refrigerant Type	R134a	Voltage	12
Oil Type	ND-oil 8	Pulley Type	Magnetic Clutch
Oil Quantity	140	Diameter	120



# A/C Components | Photo Guide - Compressors

TOYOTA		DCP50074	
Compressor Type	10PA17C	Clutch Type	L50
Refrigerant Type	R134a	Voltage	12
Oil Type	ND-oil 8	Pulley Type	Magnetic Clutch
Oil Quantity	220	Diameter	120



TOYOTA		DCP50080	
Compressor Type	10S17C	Clutch Type	LC45
Refrigerant Type	R134a	Voltage	12
Oil Type	ND-oil 8	Pulley Type	Magnetic Clutch
Oil Quantity	195	Diameter	120



TOYOTA		DCP50076	
Compressor Type	10S17C	Clutch Type	LC45
Refrigerant Type	R134a	Voltage	12
Oil Type	ND-oil 8	Pulley Type	Magnetic Clutch
Oil Quantity	180	Diameter	120



TOYOTA		DCP50081	
Compressor Type	10S17C	Clutch Type	LS45
Refrigerant Type	R134a	Voltage	12
Oil Type	ND-oil 8	Pulley Type	Magnetic Clutch
Oil Quantity	195	Diameter	120



TOYOTA		DCP50078	
Compressor Type	10PA17C	Clutch Type	L50
Refrigerant Type	R134a	Voltage	12
Oil Type	ND-oil 8	Pulley Type	Magnetic Clutch
Oil Quantity	160	Diameter	140



TOYOTA		DCP50082	
Compressor Type	10S17C	Clutch Type	LC45
Refrigerant Type	R134a	Voltage	12
Oil Type	ND-oil 8	Pulley Type	Magnetic Clutch
Oil Quantity	195	Diameter	120





# A/C Components | Photo Guide - Compressors

TOYOTA		DCP50083	
Compressor Type	10S17C	Clutch Type	LC45
Refrigerant Type	R134a	Voltage	12
Oil Type	ND-oil 8	Pulley Type	Magnetic Clutch
Oil Quantity	200	Diameter	115



TOYOTA		DCP50087	
Compressor Type	10PA20C	Clutch Type	
Refrigerant Type	R134a	Voltage	12
Oil Type	ND-oil 8	Pulley Type	Magnetic Clutch
Oil Quantity	220	Diameter	115



TOYOTA		DCP50085	
Compressor Type	10S17C	Clutch Type	LC45
Refrigerant Type	R134a	Voltage	12
Oil Type	ND-oil 8	Pulley Type	Magnetic Clutch
Oil Quantity	180	Diameter	120



TOYOTA		DCP50088	
Compressor Type	10SR19C	Clutch Type	L50T
Refrigerant Type	R134a	Voltage	12
Oil Type	ND-oil 8	Pulley Type	Magnetic Clutch
Oil Quantity	135	Diameter	120



TOYOTA		DCP50086	
Compressor Type	10S17C	Clutch Type	
Refrigerant Type	R134a	Voltage	12
Oil Type	ND-oil 8	Pulley Type	Magnetic Clutch
Oil Quantity	180	Diameter	130



TOYOTA		DCP50090	
Compressor Type	10S15L	Clutch Type	LS45
Refrigerant Type	R134a	Voltage	12
Oil Type	ND-oil 8	Pulley Type	Magnetic Clutch
Oil Quantity	120	Diameter	120



# A/C Components | Photo Guide - Compressors

TOYOTA		DCP50092	
Compressor Type	10S11C	Clutch Type	LC35
Refrigerant Type	R134a	Voltage	12
Oil Type	ND-oil 8	Pulley Type	Magnetic Clutch
Oil Quantity	80	Diameter	120



TOYOTA		DCP50097	
Compressor Type	10S17C	Clutch Type	
Refrigerant Type	R134a	Voltage	12
Oil Type	ND-oil 8	Pulley Type	Magnetic Clutch
Oil Quantity	120	Diameter	120



TOYOTA		DCP50093	
Compressor Type	10S11C	Clutch Type	LC35
Refrigerant Type	R134a	Voltage	12
Oil Type	ND-oil 8	Pulley Type	Magnetic Clutch
Oil Quantity	80	Diameter	130



TOYOTA		DCP50099	
Compressor Type	10P30C	Clutch Type	
Refrigerant Type	R134a	Voltage	24
Oil Type	ND-oil 8	Pulley Type	Magnetic Clutch
Oil Quantity	400	Diameter	155



TOYOTA		DCP50095	
Compressor Type	10S15C	Clutch Type	
Refrigerant Type	R134a	Voltage	12
Oil Type	ND-oil 8	Pulley Type	Magnetic Clutch
Oil Quantity	120	Diameter	120



TOYOTA		DCP50100	
Compressor Type	10P30C	Clutch Type	
Refrigerant Type	R134a	Voltage	12
Oil Type	ND-oil 8	Pulley Type	Magnetic Clutch
Oil Quantity	400	Diameter	155



# A/C Components

## Photo Guide - Compressors

TOYOTA		DCP50101	
Compressor Type	TSE17C	Clutch Type	
Refrigerant Type	R134a	Voltage	
Oil Type	ND-oil 8	Pulley Type	DL-Pulley
Oil Quantity	100	Diameter	120



TOYOTA		DCP50114	
Compressor Type	5SE12C	Clutch Type	DL
Refrigerant Type	R134a	Voltage	
Oil Type	ND-oil 8	Pulley Type	DL-Pulley
Oil Quantity	90	Diameter	120



TOYOTA		DCP50102	
Compressor Type	10S17C	Clutch Type	
Refrigerant Type	R134a	Voltage	12
Oil Type	ND-oil 8	Pulley Type	Magnetic Clutch
Oil Quantity	120	Diameter	130



TOYOTA		DCP50115	
Compressor Type	SCS06C	Clutch Type	LS20
Refrigerant Type	R134a	Voltage	12
Oil Type	ND-oil 8	Pulley Type	Magnetic Clutch
Oil Quantity	80	Diameter	115



TOYOTA		DCP50103	
Compressor Type	10S17C	Clutch Type	
Refrigerant Type	R134a	Voltage	12
Oil Type	ND-oil 8	Pulley Type	Magnetic Clutch
Oil Quantity	120	Diameter	120



TOYOTA		DCP50116	
Compressor Type	SCSA06C	Clutch Type	
Refrigerant Type	R134a	Voltage	12
Oil Type	ND-oil 8	Pulley Type	Magnetic Clutch
Oil Quantity	60	Diameter	110



# A/C Components | Photo Guide - Compressors

TOYOTA		DCP50120	
Compressor Type	5SE12C	Clutch Type	DL
Refrigerant Type	R134a	Voltage	
Oil Type	ND-oil 8	Pulley Type	DL-Pulley
Oil Quantity	90	Diameter	120



TOYOTA		DCP50123	
Compressor Type	5SE12C	Clutch Type	DL
Refrigerant Type	R134a	Voltage	
Oil Type	ND-oil 8	Pulley Type	DL-Pulley
Oil Quantity	90	Diameter	100



TOYOTA		DCP50121	
Compressor Type	5SE12C	Clutch Type	DL
Refrigerant Type	R134a	Voltage	
Oil Type	ND-oil 8	Pulley Type	DL-Pulley
Oil Quantity	90	Diameter	130



TOYOTA		DCP50124	
Compressor Type	5SE12C	Clutch Type	DL
Refrigerant Type	R134a	Voltage	
Oil Type	ND-oil 8	Pulley Type	DL-Pulley
Oil Quantity	90	Diameter	130



TOYOTA		DCP50122	
Compressor Type	5SE12C	Clutch Type	DL
Refrigerant Type	R134a	Voltage	
Oil Type	ND-oil 8	Pulley Type	DL-Pulley
Oil Quantity	90	Diameter	100



TOYOTA		DCP50125	
Compressor Type	TSB10C	Clutch Type	
Refrigerant Type	R134a	Voltage	12
Oil Type	ND-oil 8	Pulley Type	Magnetic Clutch
Oil Quantity	100	Diameter	105



# A/C Components | Photo Guide - Compressors

TOYOTA		DCP50126	
Compressor Type	TSB10C	Clutch Type	
Refrigerant Type	R134a	Voltage	12
Oil Type	ND-oil 8	Pulley Type	Magnetic Clutch
Oil Quantity	100	Diameter	105



TOYOTA		DCP50132	
Compressor Type	10S17C	Clutch Type	
Refrigerant Type	R134a	Voltage	12
Oil Type	ND-oil 8	Pulley Type	Magnetic Clutch
Oil Quantity	180	Diameter	110



TOYOTA		DCP50130	
Compressor Type	10S17C	Clutch Type	
Refrigerant Type	R134a	Voltage	12
Oil Type	ND-oil 8	Pulley Type	Magnetic Clutch
Oil Quantity	120	Diameter	120



TOYOTA		DCP50220	
Compressor Type	10S15C	Clutch Type	LS45
Refrigerant Type	R134a	Voltage	12
Oil Type	ND-oil 8	Pulley Type	Magnetic Clutch
Oil Quantity	120	Diameter	120



TOYOTA		DCP50131	
Compressor Type	10S17C	Clutch Type	
Refrigerant Type	R134a	Voltage	12
Oil Type	ND-oil 8	Pulley Type	Magnetic Clutch
Oil Quantity	120	Diameter	110



TOYOTA		DCP50221	
Compressor Type	10S17C	Clutch Type	LS45
Refrigerant Type	R134a	Voltage	12
Oil Type	ND-oil 8	Pulley Type	Magnetic Clutch
Oil Quantity	200	Diameter	120

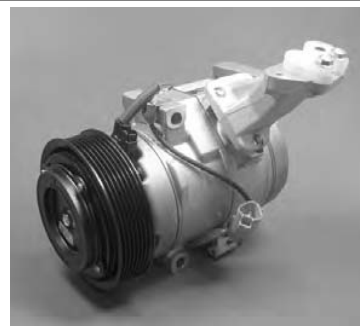

# A/C Components | Photo Guide - Compressors

TOYOTA		DCP50222	
Compressor Type	10S15L	Clutch Type	LS45
Refrigerant Type	R134a	Voltage	12
Oil Type	ND-oil 8	Pulley Type	Magnetic Clutch
Oil Quantity	120	Diameter	115



TOYOTA		DCP50225	
Compressor Type	10S15L	Clutch Type	LC45
Refrigerant Type	R134a	Voltage	12
Oil Type	ND-oil 8	Pulley Type	Magnetic Clutch
Oil Quantity	120	Diameter	115



TOYOTA		DCP50223	
Compressor Type	10S17C	Clutch Type	LS45
Refrigerant Type	R134a	Voltage	12
Oil Type	ND-oil 8	Pulley Type	Magnetic Clutch
Oil Quantity	200	Diameter	115



TOYOTA		DCP50226	
Compressor Type	10S17C	Clutch Type	LC45
Refrigerant Type	R134a	Voltage	12
Oil Type	ND-oil 8	Pulley Type	Magnetic Clutch
Oil Quantity	195	Diameter	115



TOYOTA		DCP50224	
Compressor Type	10S17C	Clutch Type	LC45
Refrigerant Type	R134a	Voltage	12
Oil Type	ND-oil 8	Pulley Type	Magnetic Clutch
Oil Quantity	200	Diameter	120



TOYOTA		DCP50228	
Compressor Type	6SEU14C	Clutch Type	DL
Refrigerant Type	R134a	Voltage	
Oil Type	ND-oil 8	Pulley Type	DL-Pulley
Oil Quantity	90	Diameter	120



# A/C Components

## Photo Guide - Compressors

TOYOTA		DCP50240	
Compressor Type	5SER09C	Clutch Type	B-PCW
Refrigerant Type	R134a	Voltage	
Oil Type	ND-oil 8	Pulley Type	DL-Pulley
Oil Quantity	60	Diameter	100



TOYOTA		DCP50243	
Compressor Type	5SER09C	Clutch Type	B-PCW
Refrigerant Type	R134a	Voltage	
Oil Type	ND-oil 8	Pulley Type	DL-Pulley
Oil Quantity	60	Diameter	110



TOYOTA		DCP50241	
Compressor Type	5SER09C	Clutch Type	B-PCW
Refrigerant Type	R134a	Voltage	
Oil Type	ND-oil 8	Pulley Type	DL-Pulley
Oil Quantity	60	Diameter	110

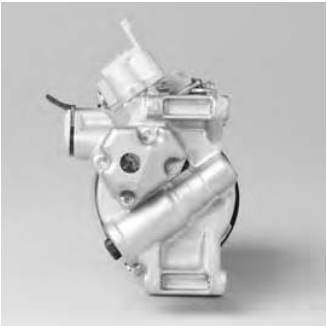

TOYOTA		DCP50245	
Compressor Type	5SE11C	Clutch Type	
Refrigerant Type	R134a	Voltage	
Oil Type	ND-oil 8	Pulley Type	DL-Pulley
Oil Quantity	90	Diameter	120



TOYOTA		DCP50242	
Compressor Type	5SER09C	Clutch Type	B-PCW
Refrigerant Type	R134a	Voltage	
Oil Type	ND-oil 8	Pulley Type	DL-Pulley
Oil Quantity	60	Diameter	110



TOYOTA		DCP50246	
Compressor Type	5SER09C	Clutch Type	
Refrigerant Type	R134a	Voltage	
Oil Type	ND-oil 8	Pulley Type	DL-Pulley
Oil Quantity	60	Diameter	100



# A/C Components | Photo Guide - Compressors

TOYOTA		DCP50248	
Compressor Type	5SER09C	Clutch Type	
Refrigerant Type	R134a	Voltage	
Oil Type	ND-oil 8	Pulley Type	DL-Pulley
Oil Quantity	60	Diameter	120



TOYOTA		DCP50251	
Compressor Type	5TSE10C	Clutch Type	DL
Refrigerant Type	R134a	Voltage	
Oil Type	ND-oil 8	Pulley Type	DL-Pulley
Oil Quantity	60	Diameter	110



TOYOTA		DCP50249	
Compressor Type	5SER09C	Clutch Type	DL
Refrigerant Type	R134a	Voltage	
Oil Type	ND-Oil 8	Pulley Type	DL-Pulley
Oil Quantity	60	Diameter	110



TOYOTA		DCP50252	
Compressor Type	5TSE10C	Clutch Type	DL
Refrigerant Type	R134a	Voltage	
Oil Type	ND-oil 8	Pulley Type	DL-Pulley
Oil Quantity	60	Diameter	110



TOYOTA		DCP50250	
Compressor Type	5TSE10C	Clutch Type	
Refrigerant Type	R134a	Voltage	
Oil Type	ND-oil 8	Pulley Type	DL-Pulley
Oil Quantity	60	Diameter	110



TOYOTA		DCP50253	
Compressor Type	5TSE10C	Clutch Type	
Refrigerant Type	R134a	Voltage	
Oil Type	ND-oil 8	Pulley Type	DL-Pulley
Oil Quantity	60	Diameter	110





# A/C Components

## Photo Guide - Compressors

TOYOTA		DCP50300	
Compressor Type	5SER09C	Clutch Type	B-PCW
Refrigerant Type	R134a	Voltage	
Oil Type	ND-oil 8	Pulley Type	DL-Pulley
Oil Quantity	60	Diameter	110



TOYOTA		DCP50304	
Compressor Type	5SER09C	Clutch Type	
Refrigerant Type	R134a	Voltage	
Oil Type	ND-oil 8	Pulley Type	DL-Pulley
Oil Quantity	60	Diameter	100



TOYOTA		DCP50301	
Compressor Type	5SE12C	Clutch Type	B-PCW
Refrigerant Type	R134a	Voltage	
Oil Type	ND-oil 8	Pulley Type	DL-Pulley
Oil Quantity	90	Diameter	110



TOYOTA		DCP50305	
Compressor Type	5SER09C	Clutch Type	
Refrigerant Type	R134a	Voltage	
Oil Type	ND-oil 8	Pulley Type	DL-Pulley
Oil Quantity	60	Diameter	100



TOYOTA		DCP50302	
Compressor Type	6SEU14C	Clutch Type	B-PCW
Refrigerant Type	R134a	Voltage	
Oil Type	ND-oil 8	Pulley Type	DL-Pulley
Oil Quantity	90	Diameter	120



TOYOTA		DCP50306	
Compressor Type	5SE12C	Clutch Type	
Refrigerant Type	R134a	Voltage	
Oil Type	ND-oil 8	Pulley Type	DL-Pulley
Oil Quantity	90	Diameter	120



# A/C Components | Photo Guide - Compressors

TOYOTA		DCP50308	
Compressor Type	5TSE10C	Clutch Type	DL
Refrigerant Type	R134a	Voltage	
Oil Type	ND-oil 8	Pulley Type	DL-Pulley
Oil Quantity	80	Diameter	110



TOYOTA		DCP50311	
Compressor Type	6SES14C	Clutch Type	DL
Refrigerant Type	R134a	Voltage	
Oil Type	ND-oil 8	Pulley Type	DL-Pulley
Oil Quantity	70	Diameter	120



TOYOTA		DCP50309	
Compressor Type	5TSE10C	Clutch Type	DL
Refrigerant Type	R134a	Voltage	
Oil Type	ND-oil 8	Pulley Type	DL-Pulley
Oil Quantity	80	Diameter	110



TOYOTA		DCP50312	
Compressor Type	6SES14C	Clutch Type	DL
Refrigerant Type	R134a	Voltage	
Oil Type	ND-Oil 8	Pulley Type	DL-Pulley
Oil Quantity	70	Diameter	120



TOYOTA		DCP50310	
Compressor Type	6SES14C	Clutch Type	DL
Refrigerant Type	R134a	Voltage	
Oil Type	ND-oil 8	Pulley Type	DL-Pulley
Oil Quantity	70	Diameter	110



TOYOTA		DCP50313	
Compressor Type	6SES14C	Clutch Type	DL
Refrigerant Type	R134a	Voltage	
Oil Type	ND-Oil 8	Pulley Type	DL-Pulley
Oil Quantity	70	Diameter	120



# A/C Components

## Photo Guide - Compressors

TOYOTA		DCP50314	
Compressor Type	5SE12C	Clutch Type	
Refrigerant Type	R134a	Voltage	
Oil Type	ND-oil 8	Pulley Type	DL-Pulley
Oil Quantity	90	Diameter	113



TOYOTA		DCP50317	
Compressor Type	5TSE10C	Clutch Type	
Refrigerant Type	R134a; R12	Voltage	
Oil Type	ND-oil 12	Pulley Type	DL-Pulley
Oil Quantity	60	Diameter	110



TOYOTA		DCP50315	
Compressor Type	SCSA08H	Clutch Type	
Refrigerant Type	R134a; R12	Voltage	12
Oil Type	ND-oil 12	Pulley Type	Magnetic Clutch
Oil Quantity	70	Diameter	100



TOYOTA		DCP50318	
Compressor Type	5TSE10C	Clutch Type	
Refrigerant Type	R134a; R12	Voltage	
Oil Type	ND-oil 12	Pulley Type	DL-Pulley
Oil Quantity	60	Diameter	110



TOYOTA		DCP50316	
Compressor Type	6SES12C	Clutch Type	
Refrigerant Type	R134a; R12	Voltage	
Oil Type	ND-oil 12	Pulley Type	
Oil Quantity		Diameter	110



TOYOTA		DCP50319	
Compressor Type	5TSE10C	Clutch Type	
Refrigerant Type	R134a	Voltage	
Oil Type	ND-oil 8	Pulley Type	DL-Pulley
Oil Quantity	80	Diameter	110



# A/C Components | Photo Guide - Compressors

TOYOTA		DCP50501	
Compressor Type	ES14	Clutch Type	
Refrigerant Type	R134a	Voltage	150,300
Oil Type	ND-oil 11	Pulley Type	DL-Pulley
Oil Quantity	130	Diameter	



TOYOTA		DCP50504	
Compressor Type	ES14	Clutch Type	
Refrigerant Type	R134a	Voltage	120,200
Oil Type	ND-oil 11	Pulley Type	DL-Pulley
Oil Quantity	115	Diameter	



TOYOTA		DCP50502	
Compressor Type	ES14	Clutch Type	
Refrigerant Type	R134a	Voltage	150,300
Oil Type	ND-oil 11	Pulley Type	DL-Pulley
Oil Quantity	130	Diameter	

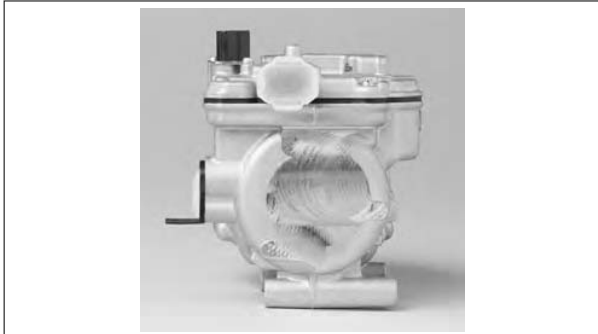

TOYOTA		DCP51000	
Compressor Type	10S15C	Clutch Type	LS45
Refrigerant Type	R134a	Voltage	12
Oil Type	ND-oil 8	Pulley Type	Magnetic Clutch
Oil Quantity	120	Diameter	140



TOYOTA		DCP50503	
Compressor Type	ES18	Clutch Type	
Refrigerant Type	R134a	Voltage	150,300
Oil Type	ND-oil 11	Pulley Type	DL-Pulley
Oil Quantity	130	Diameter	



TOYOTA		DCP51001	
Compressor Type	6SEU16C	Clutch Type	
Refrigerant Type	R134a	Voltage	
Oil Type	ND-oil 8	Pulley Type	DL-Pulley
Oil Quantity	130	Diameter	110



# A/C Components

## Photo Guide - Compressors

TOYOTA		DCP51002	
Compressor Type	6SBU16C	Clutch Type	L50S
Refrigerant Type	R134a	Voltage	12
Oil Type	ND-oil 8	Pulley Type	Magnetic Clutch
Oil Quantity	130	Diameter	115



TOYOTA		DCP51005	
Compressor Type	Old ES27	Clutch Type	
Refrigerant Type	R134a	Voltage	
Oil Type	ND-oil 11	Pulley Type	DL-Pulley
Oil Quantity	120	Diameter	



TOYOTA		DCP51003	
Compressor Type	6SEU16C	Clutch Type	
Refrigerant Type	R134a	Voltage	
Oil Type	ND-oil 8	Pulley Type	DL-Pulley
Oil Quantity	130	Diameter	115



TOYOTA		DCP51006	
Compressor Type	Old ES27	Clutch Type	
Refrigerant Type	R134a	Voltage	
Oil Type	ND-oil 11	Pulley Type	DL-Pulley
Oil Quantity	120	Diameter	



LEXUS		DCP51004	
Compressor Type	7SEH17C	Clutch Type	
Refrigerant Type	R134a	Voltage	
Oil Type	ND-oil 8	Pulley Type	DL-Pulley
Oil Quantity	130	Diameter	110



TOYOTA		DCP51007	
Compressor Type	ES27	Clutch Type	
Refrigerant Type	R134a	Voltage	
Oil Type	ND-oil 11	Pulley Type	DL-Pulley
Oil Quantity	120	Diameter	



# A/C Components | Photo Guide - Compressors

LEXUS		DCP51008	
Compressor Type	ES27	Clutch Type	
Refrigerant Type	R134a	Voltage	
Oil Type	ND-oil 11	Pulley Type	
Oil Quantity		Diameter	



TOYOTA		DCP51012	
Compressor Type	ES27	Clutch Type	
Refrigerant Type	R134a	Voltage	
Oil Type	ND-oil 11	Pulley Type	DL-Pulley
Oil Quantity	120	Diameter	



TOYOTA		DCP51010	
Compressor Type	ES27	Clutch Type	
Refrigerant Type	R134a	Voltage	
Oil Type	ND-oil 11	Pulley Type	DL-Pulley
Oil Quantity	120	Diameter	



LEXUS		DCP51015	
Compressor Type	10S17C	Clutch Type	
Refrigerant Type	R134a	Voltage	12
Oil Type	ND-oil 8	Pulley Type	Magnetic Clutch
Oil Quantity	120	Diameter	130



TOYOTA		DCP51011	
Compressor Type	ES27	Clutch Type	
Refrigerant Type	R134a	Voltage	
Oil Type	ND-oil 11	Pulley Type	DL-Pulley
Oil Quantity	120	Diameter	



LEXUS		DCP51016	
Compressor Type	6SBU16C	Clutch Type	
Refrigerant Type	R134a	Voltage	12
Oil Type	ND-oil 8	Pulley Type	Magnetic Clutch
Oil Quantity	130	Diameter	110



# A/C Components | Photo Guide - Compressors

JEEP		DCP99001	
Compressor Type	10PA17C	Clutch Type	
Refrigerant Type	R134a	Voltage	12
Oil Type	ND-oil 8	Pulley Type	Magnetic Clutch
Oil Quantity	220	Diameter	136.5



JEEP		DCP99004	
Compressor Type	10PA17C	Clutch Type	Direct-Drive
Refrigerant Type	R134a	Voltage	12
Oil Type	ND-oil 8	Pulley Type	Magnetic Clutch
Oil Quantity	150	Diameter	123.8



JEEP		DCP99002	
Compressor Type	10PA17J	Clutch Type	L50
Refrigerant Type	R134a	Voltage	12
Oil Type	ND-oil 8	Pulley Type	Magnetic Clutch
Oil Quantity	220	Diameter	136.5



JEEP		DCP99005	
Compressor Type	10PA17C	Clutch Type	L50
Refrigerant Type	R134a	Voltage	12
Oil Type	ND-oil 8	Pulley Type	Magnetic Clutch
Oil Quantity	240	Diameter	120



JEEP		DCP99003	
Compressor Type	10PA17C	Clutch Type	Direct-Drive
Refrigerant Type	R134a	Voltage	12
Oil Type	ND-oil 8	Pulley Type	Magnetic Clutch
Oil Quantity	230	Diameter	123.8



DAIHATSU		DCP99017	
Compressor Type	SV07C	Clutch Type	K20
Refrigerant Type	R134a	Voltage	12
Oil Type	ND-oil 8	Pulley Type	Magnetic Clutch
Oil Quantity	80	Diameter	108



HUMMER		DCP99020	
Compressor Type	10S17F	Clutch Type	
Refrigerant Type	R134a	Voltage	12
Oil Type	ND-oil 8	Pulley Type	Magnetic Clutch
Oil Quantity	210	Diameter	110



FENDT		DCP99502	
Compressor Type	10PA15C	Clutch Type	L50
Refrigerant Type	R134a	Voltage	12
Oil Type	ND-oil 8	Pulley Type	Magnetic Clutch
Oil Quantity	180	Diameter	130



VDL		DCP99022	
Compressor Type	10PA20C	Clutch Type	
Refrigerant Type	R134a	Voltage	24
Oil Type	ND-Oil 8	Pulley Type	Magnetic Clutch
Oil Quantity	140	Diameter	140



JOHN DEERE		DCP99504	
Compressor Type	10PA15C	Clutch Type	L50
Refrigerant Type	R134a	Voltage	12
Oil Type	ND-oil 8	Pulley Type	Magnetic Clutch
Oil Quantity	160	Diameter	130



VDL		DCP99023	
Compressor Type	10PA20C	Clutch Type	
Refrigerant Type	R134a	Voltage	24
Oil Type	ND-Oil 8	Pulley Type	Magnetic Clutch
Oil Quantity	140	Diameter	120



JOHN DEERE		DCP99505	
Compressor Type	10PA15C	Clutch Type	
Refrigerant Type	R134a	Voltage	12
Oil Type	ND-oil 8	Pulley Type	Magnetic Clutch
Oil Quantity	160	Diameter	119,6





# A/C Components

## Photo Guide - Compressors

JOHN DEERE		DCP99510	
Compressor Type	10PA17C	Clutch Type	L50
Refrigerant Type	R134a	Voltage	12
Oil Type	ND-oil 8	Pulley Type	Magnetic Clutch
Oil Quantity	240	Diameter	140



JOHN DEERE		DCP99513	
Compressor Type	10PA15C	Clutch Type	L50
Refrigerant Type	R134a	Voltage	12
Oil Type	ND-oil 8	Pulley Type	Magnetic Clutch
Oil Quantity	170	Diameter	119.6



JOHN DEERE		DCP99511	
Compressor Type	10PA17C	Clutch Type	L50
Refrigerant Type	R134a	Voltage	24
Oil Type	ND-oil 8	Pulley Type	Magnetic Clutch
Oil Quantity	240	Diameter	140



JOHN DEERE		DCP99515	
Compressor Type	6E171	Clutch Type	145P
Refrigerant Type	R12 (Retrof)	Voltage	12
Oil Type	ND-oil 6	Pulley Type	Magnetic Clutch
Oil Quantity	80	Diameter	145



JOHN DEERE		DCP99512	
Compressor Type	10PA15C	Clutch Type	L50
Refrigerant Type	R134a	Voltage	12
Oil Type	ND-oil 8	Pulley Type	Magnetic Clutch
Oil Quantity	170	Diameter	119.6



JOHN DEERE		DCP99517	
Compressor Type	10PA17C	Clutch Type	L50
Refrigerant Type	R134a	Voltage	12
Oil Type	ND-oil 8	Pulley Type	Magnetic Clutch
Oil Quantity	230	Diameter	140



# A/C Components | Photo Guide - Compressors

FENDT		DCP99518	
Compressor Type	10S15C	Clutch Type	
Refrigerant Type	R134a	Voltage	12
Oil Type	ND-oil 8	Pulley Type	Magnetic Clutch
Oil Quantity	180	Diameter	



JOHN DEERE		DCP99521	
Compressor Type	10PA17C	Clutch Type	L50
Refrigerant Type	R134a	Voltage	12
Oil Type	ND-oil 8	Pulley Type	Magnetic Clutch
Oil Quantity	220	Diameter	145



DEUTZ		DCP99519	
Compressor Type	10S17C	Clutch Type	
Refrigerant Type	R134a	Voltage	12
Oil Type	ND-oil 8	Pulley Type	Magnetic Clutch
Oil Quantity	220	Diameter	120



JOHN DEERE		DCP99522	
Compressor Type	10PA17C	Clutch Type	L50
Refrigerant Type	R134a	Voltage	24
Oil Type	ND-oil 8	Pulley Type	Magnetic Clutch
Oil Quantity	220	Diameter	145



JOHN DEERE		DCP99520	
Compressor Type	10SRE18C	Clutch Type	
Refrigerant Type	R134a	Voltage	12
Oil Type	ND-oil 8	Pulley Type	Magnetic Clutch
Oil Quantity	160	Diameter	120



JOHN DEERE		DCP99523	
Compressor Type	10PA17C	Clutch Type	L50
Refrigerant Type	R134a	Voltage	24
Oil Type	ND-oil 8	Pulley Type	Magnetic Clutch
Oil Quantity	220	Diameter	140



# A/C Components

## Photo Guide - Compressors

JOHN DEERE		DCP99524	
Compressor Type	SCSA06C	Clutch Type	LC20
Refrigerant Type	R134a	Voltage	12
Oil Type	ND-oil 8	Pulley Type	Magnetic Clutch
Oil Quantity	60	Diameter	105



JOHN DEERE		DCP99527	
Compressor Type	10PA17C	Clutch Type	
Refrigerant Type	R134a	Voltage	12
Oil Type	ND-oil 8	Pulley Type	Magnetic Clutch
Oil Quantity	220	Diameter	140



JOHN DEERE		DCP99525	
Compressor Type	10PA17C	Clutch Type	L50
Refrigerant Type	R134a	Voltage	12
Oil Type	ND-oil 8	Pulley Type	Magnetic Clutch
Oil Quantity	230	Diameter	140



JOHN DEERE		DCP99528	
Compressor Type	10PA17C	Clutch Type	
Refrigerant Type	R134a	Voltage	12
Oil Type	ND-oil 8	Pulley Type	Magnetic Clutch
Oil Quantity	230	Diameter	120



AGCO		DCP99526	
Compressor Type	10S17C	Clutch Type	
Refrigerant Type	R134a	Voltage	
Oil Type	ND-oil 8	Pulley Type	
Oil Quantity		Diameter	



JOHN DEERE		DCP99529	
Compressor Type	SCSA06C	Clutch Type	
Refrigerant Type	R134a	Voltage	12
Oil Type	ND-oil 8	Pulley Type	Magnetic Clutch
Oil Quantity	60	Diameter	120



# A/C Components | Photo Guide - Compressors

JOHN DEERE		DCP99530	
Compressor Type	10PA17C	Clutch Type	
Refrigerant Type	R134a	Voltage	12
Oil Type	ND-oil 8	Pulley Type	Magnetic Clutch
Oil Quantity	230	Diameter	145



CATERPILLAR		DCP99802	
Compressor Type	10S17C	Clutch Type	L50T
Refrigerant Type	R134a	Voltage	24
Oil Type	ND-oil 8	Pulley Type	Magnetic Clutch
Oil Quantity	180	Diameter	140



CATERPILLAR		DCP99800	
Compressor Type	10S17C	Clutch Type	L50T
Refrigerant Type	R134a	Voltage	24
Oil Type	ND-oil 8	Pulley Type	Magnetic Clutch
Oil Quantity	200	Diameter	140



CATERPILLAR		DCP99803	
Compressor Type	10S17C	Clutch Type	L50T
Refrigerant Type	R134a	Voltage	24
Oil Type	ND-oil 8	Pulley Type	Magnetic Clutch
Oil Quantity	180	Diameter	133



CATERPILLAR		DCP99801	
Compressor Type	10S17C	Clutch Type	L50T
Refrigerant Type	R134a	Voltage	24
Oil Type	ND-oil 8	Pulley Type	Magnetic Clutch
Oil Quantity	200	Diameter	140



CATERPILLAR		DCP99807	
Compressor Type	10S17C	Clutch Type	L50T
Refrigerant Type	R134a	Voltage	24
Oil Type	ND-oil 8	Pulley Type	Magnetic Clutch
Oil Quantity	160	Diameter	133



# A/C Components

## Photo Guide - Compressors

CATERPILLAR		DCP99809	
Compressor Type	10S17C	Clutch Type	L50T
Refrigerant Type	R134a	Voltage	24
Oil Type	ND-oil 8	Pulley Type	Magnetic Clutch
Oil Quantity	160	Diameter	133



CATERPILLAR		DCP99812	
Compressor Type	10S17C	Clutch Type	
Refrigerant Type	R134a	Voltage	24
Oil Type	ND-oil 8	Pulley Type	Magnetic Clutch
Oil Quantity	200	Diameter	140



CATERPILLAR		DCP99810	
Compressor Type	10PA15C	Clutch Type	
Refrigerant Type	R134a	Voltage	
Oil Type	ND-oil 8	Pulley Type	DL-Pulley
Oil Quantity	180	Diameter	133



KOMATSU		DCP99820	
Compressor Type	10PA15C	Clutch Type	L50
Refrigerant Type	R134a	Voltage	24
Oil Type	ND-oil 8	Pulley Type	Magnetic Clutch
Oil Quantity	180	Diameter	150



CATERPILLAR		DCP99811	
Compressor Type	10S17C	Clutch Type	
Refrigerant Type	R134a	Voltage	
Oil Type	ND-oil 8	Pulley Type	
Oil Quantity		Diameter	133



KOMATSU		DCP99821	
Compressor Type	10S15C	Clutch Type	L50T
Refrigerant Type	R134a	Voltage	24
Oil Type	ND-oil 8	Pulley Type	Magnetic Clutch
Oil Quantity	180	Diameter	150



# A/C Components | Photo Guide - Compressors

KOMATSU		DCP99822	
Compressor Type	10S15C	Clutch Type	L50T
Refrigerant Type	R134a	Voltage	24
Oil Type	ND-oil 8	Pulley Type	Magnetic Clutch
Oil Quantity	180	Diameter	150



KUBOTA		DCP99831	
Compressor Type	SCS06C	Clutch Type	
Refrigerant Type	R134a	Voltage	12
Oil Type	ND-oil 8	Pulley Type	Magnetic Clutch
Oil Quantity	80	Diameter	120



KOMATSU		DCP99823	
Compressor Type	10PA15C	Clutch Type	
Refrigerant Type	R134a	Voltage	
Oil Type	ND-oil 8	Pulley Type	
Oil Quantity		Diameter	



KUBOTA		DCP99832	
Compressor Type	SV06E	Clutch Type	
Refrigerant Type	R134a	Voltage	12
Oil Type	ND-oil 8	Pulley Type	Magnetic Clutch
Oil Quantity	110	Diameter	108



KUBOTA		DCP99830	
Compressor Type	SV07E	Clutch Type	
Refrigerant Type	R134a	Voltage	12
Oil Type	ND-oil 8	Pulley Type	Magnetic Clutch
Oil Quantity	110	Diameter	108

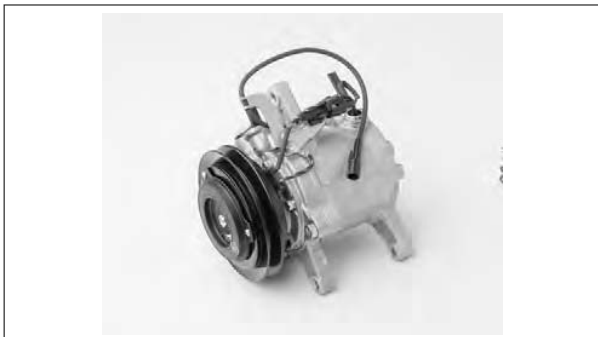

# DENSO Cross Reference Chart – Compressors

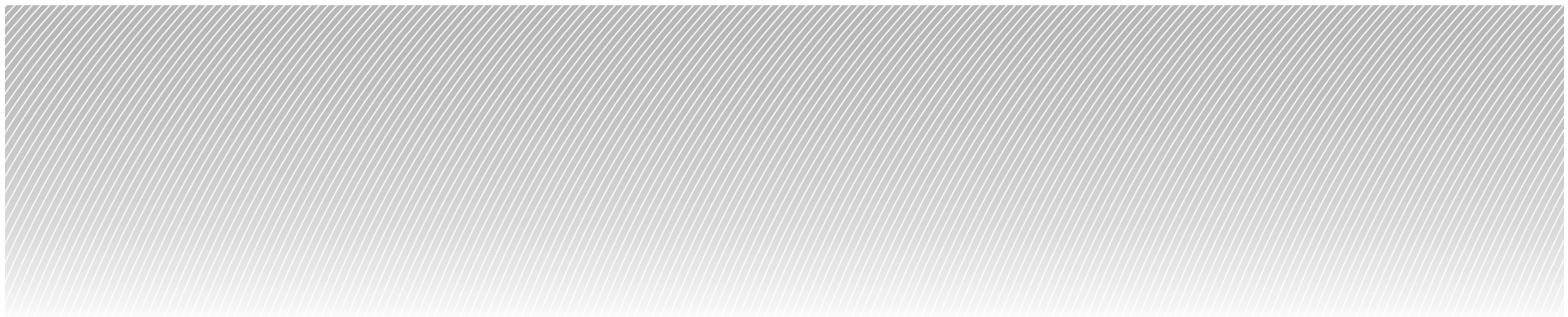

# A/C Components

## Cross Reference Chart - OE > Short Code

AGCO	DENSO
ACV0059750	DCP99526

ASTON MARTIN	DENSO
4G43-19D629-AA	DCP11008
6G33-19D629-AA	DCP11008
6G33-19D629-AB	DCP11008

AUDI	DENSO
034260805A	DCP02002
034260805B	DCP02001
034260805C	DCP02002
034260805D	DCP02001
034260808	DCP02001
034260808A	DCP02002
034260808B	DCP02001
034260808C	DCP02002
1K0820803A	DCP32003
1K0820803E	DCP32045
1K0820803F	DCP32003
1K0820803G	DCP32045
1K0820803J	DCP32003
1K0820803P	DCP32045
1K0820803Q	DCP32045
1K0820803S	DCP32045
1K0820808A	DCP02050
1K0820808AX	DCP02050
1K0820808B	DCP32045
1K0820808BX	DCP32045
1K0820808D	DCP32045
1K0820808DX	DCP32045
1K0820808F	DCP32045
1K0820859C	DCP32045
1K0820859E	DCP32045
1K0820859F	DCP32045
1K0820859H	DCP02050
1K0820859J	DCP02030
1K0820859M	DCP32045
1K0820859N	DCP02030
1K0820859P	DCP02050
1K0820859QX	DCP32045
1K0820859S	DCP32045
1K0820859SX	DCP32045
1K0820859T	DCP02030
1K0820859TX	DCP02030
400260805B	DCP02015
4B0260805B	DCP02005
4B0260805BX	DCP02005
4B0260805C	DCP02004
4B0260805G	DCP02011
4B0260805H	DCP02046
4B0260805J	DCP02013
4B0260805K	DCP02011
4B0260805M	DCP02011
4B0260805N	DCP02004
4B0260805P	DCP02004
4B0260805Q	DCP02005
4B0260805R	DCP02004
4B3260805	DCP02005
4D0260805B	DCP02005
4D0260805C	DCP02004
4D0260808	DCP02005
4E0260805AA	DCP02033
4E0260805AB	DCP02035
4E0260805AC	DCP02034
4E0260805AD	DCP02035
4E0260805AG	DCP02032
4E0260805AG	DCP02034
4E0260805AJ	DCP02035
4E0260805AK	DCP02063
4E0260805AL	DCP02033
4E0260805AM	DCP02015

AUDI	DENSO
4E0260805AP	DCP02035
4E0260805AQ	DCP02063
4E0260805AR	DCP02031
4E0260805AR	DCP02033
4E0260805AS	DCP02015
4E0260805BA	DCP02035
4E0260805BC	DCP02063
4E0260805C	DCP02091
4E0260805E	DCP02022
4E0260805E	DCP02025
4E0260805F	DCP02009
4E0260805G	DCP02034
4E0260805J	DCP02035
4E0260805N	DCP02035
4E0260805Q	DCP02015
4F0260805AA	DCP02040
4F0260805AB	DCP02036
4F0260805AC	DCP02037
4F0260805AD	DCP02015
4F0260805AE	DCP02040
4F0260805AF	DCP02036
4F0260805AG	DCP02037
4F0260805AH	DCP02015
4F0260805AJ	DCP02090
4F0260805AL	DCP02042
4F0260805AN	DCP02042
4F0260805AP	DCP02042
4F0260805AR	DCP02033
4F0260805D	DCP02016
4F0260805E	DCP02055
4F0260805F	DCP02016
4F0260805G	DCP02014
4F0260805H	DCP02036
4F0260805J	DCP02037
4F0260805K	DCP02016
4F0260805L	DCP02015
4F0260805M	DCP02014
4F0260805N	DCP02037
4F0260805P	DCP02014
4F0260805Q	DCP02016
4F0260805R	DCP02036
4F0260805S	DCP02037
4F0260805T	DCP02040
4G0260805B	DCP02099
4H0260805	DCP02034
4H0260805A	DCP02034
4H0260805G	DCP32062
4Z0260805	DCP02047
4Z7260805	DCP02055
4Z7260805E	DCP02015
4Z7260805F	DCP02055
5K0820803	DCP02050
5K0820803	DCP32060
5K0820803C	DCP02050
5K0820803C	DCP32060
5K0820803X	DCP02050
5K0820803X	DCP32060
5N0820803B	DCP02050
5N0820803B	DCP32060
5N0820803C	DCP02050
5N0820803C	DCP32060
5N0820803E	DCP02050
5N0820803G	DCP02050
5N0820803G	DCP32060
5N0820803H	DCP02050
5N0820803HX	DCP32060
5Q0820803	DCP32060
5Q0820803A	DCP32060
5Q0820803B	DCP32060
5Q0820803C	DCP32060

AUDI	DENSO
5Q0820803D	DCP32060
5Q0820803E	DCP32060
5Q0820803F	DCP32060
600820803G	DCP27002
600820803GX	DCP27002
77260803A	DCP02003
77260803C	DCP02003
7L6820803C	DCP32022
7L6820803F	DCP32022
7L6820803J	DCP32022
7L6820803K	DCP32022
7L6820803M	DCP32022
7L6820803Q	DCP32022
7L6820803T	DCP32022
7P0820803D	DCP32022
7P0820803E	DCP32031
7P0820803N	DCP32022
8D0260805B	DCP02006
8D0260805C	DCP32001
8D0260805J	DCP02006
8D0260805K	DCP32001
8D0260805P	DCP02006
8D0260805Q	DCP02006
8D0260805R	DCP02006
8D0260805RX	DCP02006
8D0260808	DCP02006
8E0260805	DCP02010
8E0260805AB	DCP02010
8E0260805AC	DCP02061
8E0260805AF	DCP02012
8E0260805AG	DCP02038
8E0260805AH	DCP02024
8E0260805AJ	DCP02027
8E0260805AK	DCP02039
8E0260805AS	DCP02028
8E0260805AT	DCP02038
8E0260805BA	DCP02038
8E0260805BC	DCP02043
8E0260805BD	DCP02033
8E0260805BE	DCP02038
8E0260805BF	DCP02038
8E0260805BG	DCP02033
8E0260805BH	DCP02039
8E0260805BJ	DCP02038
8E0260805BK	DCP02033
8E0260805BL	DCP02038
8E0260805BM	DCP02034
8E0260805BN	DCP02039
8E0260805BP	DCP02041
8E0260805BQ	DCP02052
8E0260805BR	DCP02052
8E0260805BS	DCP02041
8E0260805BT	DCP02033
8E0260805C	DCP02008
8E0260805CA	DCP02038
8E0260805CB	DCP02041
8E0260805CC	DCP02052
8E0260805CD	DCP02065
8E0260805CE	DCP02033
8E0260805CG	DCP02052
8E0260805F	DCP02045
8E0260805G	DCP02048
8E0260805M	DCP02010
8E0260805N	DCP02010
8E0260805R	DCP02023
8E0260805S	DCP02025
8E0260805T	DCP02026
8H0260805B	DCP02034
8J0260805	DCP02030
8K0260805	DCP02042
8K0260805A	DCP02043

AUDI	DENSO
8K0260805B	DCP02015
8K0260805C	DCP02044
8K0260805D	DCP02043
8K0260805E	DCP02042
8K0260805F	DCP02044
8K0260805G	DCP02043
8K0260805H	DCP02015
8K0260805H	DCP02064
8K0260805J	DCP02092
8K0260805K	DCP02043
8K0260805L	DCP02042
8K0260805N	DCP02101
8K0260805P	DCP02044
8K0260805Q	DCP02101
8KD260805	DCP02060
8T0260805E	DCP02097
8T0260805F	DCP02098
8T0260805H	DCP02102
8T0260805N	DCP02097
8T0260805P	DCP02098
8T0260805R	DCP02102
8T0260805S	DCP02098
8Z0260805	DCP02007
8Z0260805A	DCP02007

BMW	DENSO
63526946871	DCP05034
64506901781	DCP05082
64506901783	DCP05094
64506947132	DCP05102
64509118602	DCP05092
64509154071	DCP05080
64509154072	DCP05076
64509174802	DCP05020
64509174803	DCP05032
64509174805	DCP05052
64509174806	DCP05084
64509174807	DCP05102
64509175481	DCP05021
64509180547	DCP05082
64509180548	DCP05092
64509180549	DCP05093
64509180550	DCP05079
64509192317	DCP05080
64509196890	DCP05081
64521369418	DCP05012
64521385161	DCP05003
64526901781	DCP05021
64526901783	DCP05094
64526901784	DCP05107
64526904014	DCP05018
64526904015	DCP05016
64526904017	DCP05017
64526904018	DCP05014
64526909628	DCP05046
64526910458	DCP05014
64526910459	DCP05014
64526910460	DCP05016
64526911340	DCP05018
64526911341	DCP05014
64526911342	DCP05016
64526914369	DCP05017
64526914370	DCP05018
64526914371	DCP05019
64526915083	DCP05052
64526915388	DCP05039
64526915388	DCP05040
64526916232	DCP05039
64526917859	DCP05020
64526918749	DCP05031
64526918753	DCP05032



# A/C Components

## Cross Reference Chart - OE > Short Code

BMW	DENSO
64526921651	DCP05046
64526922397	DCP05022
64526924788	DCP05038
64526924792	DCP05037
64526925720	DCP05107
64526925721	DCP05021
64526933174	DCP05079
64526935613	DCP05026
64526936883	DCP05039
64526946871	DCP05034
64526950152	DCP05042
64526953474	DCP05052
64526956493	DCP05039
64526956715	DCP05032
64526956716	DCP05045
64526956719	DCP05033
64526961618	DCP05108
64526961621	DCP05083
64526980044	DCP05062
64526980085	DCP05060
64526983098	DCP05020
64526987766	DCP05026
64526987862	DCP05050
64526987863	DCP05061
64526987890	DCP05077
64528362414	DCP05018
64528363275	DCP05017
64528363485	DCP05019
64528363551	DCP05012
64528367983	DCP05009
64528371021	DCP05010
64528377241	DCP05014
64528377242	DCP05013
64528377244	DCP05016
64528379924	DCP05014
64528381233	DCP05016
64528385050	DCP05013
64528385161	DCP05003
64528385915	DCP05003
64528385917	DCP05008
64528385919	DCP05018
64528386451	DCP05014
64528390741	DCP05003
64528390743	DCP05001
64528390964	DCP05006
64528391135	DCP05004
64528391693	DCP05007
64528391694	DCP05003
64528391695	DCP05010
64528391880	DCP05008
64529118602	DCP05035
64529122618	DCP05036
64529122619	DCP05088
64529122705	DCP05084
64529154070	DCP05078
64529154072	DCP05076
64529160816	DCP05079
64529165808	DCP05081
64529174803	DCP05032
64529174804	DCP05060
64529174806	DCP05084
64529174807	DCP05102
64529175481	DCP05021
64529180547	DCP05082
64529188326	DCP05033
64529192317	DCP05080
64529195721	DCP05060
64529195977	DCP05080
64529195978	DCP05076
64529196889	DCP05077
64529211496	DCP05089

BMW	DENSO
64529216466	DCP05096
64529216467	DCP05097
64529217868	DCP05078
64529217869	DCP05090
64529222296	DCP05104
64529222308	DCP05098
64529223694	DCP05095
64529223695	DCP05099
64529225703	DCP05095
64529225704	DCP05091
64529330825	DCP05115
64529330827	DCP05114
64529330829	DCP05106
64529330831	DCP05105
65428377244	DCP05016
65526924788	DCP05038
65526924792	DCP05037
65526956719	DCP05033

CATERPILLAR	DENSO
15404-90	DCP99810
17855-45	DCP99802
231-6984	DCP99803
24577-79	DCP99800
24577-81	DCP99807
25972-44	DCP99809
30503-24	DCP99800
30503-25	DCP99801

CHEVROLET	DENSO
89024881	DCP15001

CHRYSLER	DENSO
04677040E	DCP06001
046771144	DCP06006
04677144AB	DCP06006
04677144ABE	DCP06005
04677156	DCP06006
04677156AB	DCP06006
04677205AB	DCP06003
04677205L	DCP06003
04677299C	DCP06002
04677445	DCP99003
04677445D	DCP99003
05005420AD	DCP06016
05005420AF	DCP06016
05005421AD	DCP06018
05005440AA	DCP06017
05005440AD	DCP06017
05005440AF	DCP06017
05005441AA	DCP06017
05005441AC	DCP06017
05005441AD	DCP06017
05005441AE	DCP06017
05005441AF	DCP06017
05005441AH	DCP06017
05005441AI	DCP06017
05005441AJ	DCP06017
05058228AI	DCP06022
05080494AA	DCP06012
05080494AB	DCP06012
05080494AC	DCP06012
05278462AA	DCP06009
055056336AC	DCP06026
4677040E	DCP06001
46771144	DCP06006
4677156	DCP06006
4677156AB	DCP06006
4677205	DCP06003

CHRYSLER	DENSO
4677205AB	DCP06003
4677205L	DCP06003
4677299C	DCP06002
4677445	DCP99003
4677445D	DCP99003
4746858	DCP99003
5005420AA	DCP06016
5005420AC	DCP06016
5005420AD	DCP06016
5005420AE	DCP06016
5005420AF	DCP06016
5005421AA	DCP06018
5005421AB	DCP06018
5005421AC	DCP06018
5005421AD	DCP06018
5005421AE	DCP06018
5005440AA	DCP06017
5005440AD	DCP06017
5005440AF	DCP06017
5005441AA	DCP06017
5005441AB	DCP06017
5005441AC	DCP06017
5005441AD	DCP06017
5005441AE	DCP06017
5005441AF	DCP06017
5005441AH	DCP06017
5005441AI	DCP06017
5005441AJ	DCP06017
5058228AG	DCP06022
5058228AH	DCP06022
5058228AI	DCP06022
5080494AA	DCP06012
5080494AB	DCP06012
5080494AC	DCP06012
5264732	DCP06009
5278462AA	DCP06009
5278462AD	DCP06009
55035993	DCP99003
55035993AB	DCP99003
55035993E	DCP99003
55036412	DCP99004
55036412B	DCP99004
55037467AA	DCP06025
55037467AB	DCP06025
55037467AD	DCP06025
55056336AC	DCP06026
55111035AA	DCP06027
55111035AB	DCP06027
55111035ABA	DCP06027
55111423AC	DCP06022
55111423AD	DCP06022
55111423AE	DCP06022
55111423AF	DCP06022
55111423AG	DCP06022
55111423AH	DCP06022
55111423AI	DCP06022
55111425AA	DCP06029
55111425AB	DCP06029
55111425AC	DCP06029
55116835AC	DCP06020
55116835AD	DCP06020
55116835AE	DCP06020
55116835AF	DCP06020
55116839AA	DCP06021
55116839AE	DCP06020
K55116839AA	DCP06021

CITROEN/PEUGEOT	DENSO
1606467480	DCP21021
1608325980	DCP21015
6453WF	DCP21021

CITROEN/PEUGEOT	DENSO
6453WH	DCP21014
6453YQ	DCP07010
6487.39	DCP21021
6487.41	DCP21014
648738	DCP21021
648739	DCP21021
648740	DCP21014
648741	DCP21014
648742	DCP07010
96 722 470 80	DCP21015
96 756 558 80	DCP21016
96 756 578 80	DCP21017
96 756 599 80	DCP21017
96 768 623 80	DCP21021
96 598 754 80	DCP21021
96 598 755 80	DCP21014
96 840 758 80	DCP07010
96 890 798 80	DCP21021
96 890 847 80	DCP21014
96 890 848 80	DCP07010
9659875480	DCP21021
9659875580	DCP21014
9672247080	DCP21015
9675655880	DCP21016
9675657880	DCP21017
9675659880	DCP21016
9675659980	DCP21017
9676443980	DCP21021
9676862380	DCP21021
9689079880	DCP21021
9689084780	DCP21014
9801764380	DCP21022
9802875780	DCP21022
9807722580	DCP21016
9809274280	DCP21016
9810347280	DCP21016
9819714880	DCP21022
9819714980	DCP21022
9822101380	DCP21021
9822101780	DCP21021

CLAAS	DENSO
1032752.1	DCP23531
21894090	DCP23540
21894130	DCP23541
21894190	DCP23539
4572300211	DCP17505
4572300411	DCP17125
4572300711	DCP17125
796999.1	DCP17501
7969991	DCP17501
9062302011	DCP17501
A4572300211	DCP17505
A4572300411	DCP17125
A4572300711	DCP17125
A9062302011	DCP17501

DAIHATSU	DENSO
8831097405	DCP49002
8831097405000	DCP49002
88310-97405-000	DCP49002
88310B1070	DCP49001
88310-B1070	DCP49001
88310B1070000	DCP49001
88310-B1070-000	DCP49001
88310BZ160	DCP49001
88310-BZ160	DCP49001
8832087401000	DCP49001
88320-87401-000	DCP49001
88320-97401	DCP49001
8832097401000	DCP49001

# A/C Components

## Cross Reference Chart - OE > Short Code

DAIHATSU	DENSO
88320-97401-000	DCP49001
88410-97212	DCP49002
88410-B1030	DCP49001

DEUTZ	DENSO
04293225	DCP99519
4293225	DCP99519

DODGE	DENSO
68012250	DCP17122

FENDT	DENSO
199551020010	DCP99B03
385551020010	DCP99B03
G117551020110	DCP99518
G199551020010	DCP99B03
G311 550 020 100	DCP99502
G311550020100	DCP99502
G385551020010	DCP99B03

FIAT	DENSO
46336396	DCP01001
46427592	DCP09011
46438366	DCP09009
46438576	DCP09006
46449285	DCP09011
46479556	DCP09011
46514137	DCP09011
46514443	DCP09007
46514636	DCP09013
46536396	DCP01001
46542341	DCP09014
46542431	DCP09014
46757168	DCP09005
46757377	DCP09007
46757907	DCP09001
46775094	DCP01001
46782669	DCP09004
46785772	DCP09005
46785773	DCP09007
46786262	DCP09001
46809223	DCP09002
46811244	DCP09008
46819144	DCP09003
48785772	DCP09005
50503374	DCP01001
50541342	DCP09062
50541343	DCP09063
50541346	DCP09064
5077705	DCP09012
50777050	DCP09012
5077706	DCP09015
50777060	DCP09015
51746931	DCP09003
51747318	DCP09004
51752531	DCP09008
51794515	DCP09020
51815102	DCP01015
51820449	DCP13010
51831803	DCP13005
51906240	DCP09032
51935564	DCP09032
51939001	DCP09032
51939001	DCP09034
52060460	DCP09060
52060461	DCP09061
5440709	DCP09009
54407090	DCP09009
5440710	DCP09006
54407100	DCP09006
55194880	DCP09016

FIAT	DENSO
55701201	DCP09017
55702161	DCP20022
55702661	DCP20023
55703917	DCP20022
55897000	DCP09014
5A79753	DCP09003
5D33751	DCP20022
5D337510	DCP20022
5D337520	DCP09016
60654446	DCP09001
60812516	DCP09009
60814101	DCP01001
60814720	DCP09001
60815788	DCP09001
60815796	DCP01001
60816191	DCP01001
71721731	DCP01001
71721733	DCP09004
71721735	DCP09005
71721737	DCP09001
71724083	DCP09020
71746716	DCP09017
71781765	DCP01001
71781767	DCP09004
71781767	DCP09061
71785265	DCP09003
71785268	DCP09004
71785269	DCP09004
71785269	DCP09061
71789105	DCP09016
71789108	DCP13005
71793072	DCP09020
71793959	DCP09020
7736928	DCP09015
77384720	DCP01004
7741901	DCP09012
7765865	DCP09010
7775422	DCP13001
88410-87106	DCP09006
88410-87106	DCP09014
88410-87106	DCP09015

FIAT GROUP	DENSO
51803075	DCP09K22
55703917	DCP09K22

FORD	DENSO
1535408	DCP09004
1537745	DCP09003
9S5119D623AA	DCP09004
9S51-19D623-AA	DCP09004
9S5119D623BA	DCP09003
9S51-19D623-BA	DCP09003

GM	DENSO
20931259	DCP15001
24416177	DCP20004
24416178	DCP20005
24428118	DCP20004
24430230	DCP20004
24430319	DCP20005
24443138	DCP20030
4541207	DCP25001
4869483	DCP25001
5048095	DCP25001
55352021	DCP20021K
55565236	DCP20021K
55701200	DCP20021
55701200	DCP20021K
55703721	DCP20022
5E527520	DCP20021

GM	DENSO
5E527520	DCP20021K
5E527540	DCP20022
90 457 635	DCP20001
90457635	DCP20001
90507617	DCP20003
90564976	DCP20006
9122119	DCP20004
9212120	DCP20005
93176862	DCP20005
93190812	DCP20021
93190812	DCP20021K
93190814	DCP20023
93190815	DCP20022
R1580029	DCP20005

HONDA	DENSO
38800PDAE01	DCP40002
38800-PDA-E01	DCP40002
38800R06G01	DCP40004
38800-R06-G01	DCP40004
38800RAAA01	DCP40012
38800-RAA-A01	DCP40012
38800RJJ0031	DCP40015
38800-RJJ-0031	DCP40015
38800-RMA-G021	DCP40003
38810PDAE01	DCP40002
38810-PDA-E01	DCP40002
38810R06G01	DCP40004
38810-R06-G01	DCP40004
38810R7CG02	DCP40017
38810RFWG01	DCP40018
38810-RMA-G01	DCP40003
38810-RMA-G02	DCP40003

HUMMER	DENSO
20931258	DCP99020
89024882	DCP99020

ISUZU	DENSO
8973557690	DCP23025
8-97355769-0	DCP23025

IVECO	DENSO
500313156	DCP12001
500341617	DCP12005
500381465	DCP12004
504014391	DCP12003
504228992	DCP12008
504277234	DCP12003
504384698	DCP12003
504385144	DCP12008
504385146	DCP12009
5801362246	DCP12012
98497470	DCP12008
99488569	DCP12009

JAGUAR	DENSO
2W93-19D629-AE	DCP11045
2W93-19D629-BC	DCP11010
2W93-19D629-BF	DCP11010
2W93-19D629-CD	DCP11011
3W83-19D629-AA	DCP11007
3W83-19D629-AB	DCP11007
6W93-19D629-AA	DCP11012
6W93-19D629-AB	DCP11012
C2C26770	DCP11011
CCC5992	DCP11001
MCA7300AD	DCP11002
MCA7300AE	DCP11003
MNA7300AA	DCP11001
MNA7300AB	DCP11001

JEEP	DENSO
35232010F	DCP99005
55036151	DCP99001
55036151G	DCP99001
56006551	DCP99002
56006551H	DCP99002

JOHN DEERE	DENSO
259-7243	DCP99812
AH169875	DCP99517
AL153386	DCP99505
AL154203	DCP99505
AL155836	DCP99512
AL174136	DCP99505
AL174137	DCP99505
AL176857	DCP99505
AL176858	DCP99513
AL78779	DCP99505
AN221429	DCP99525
AT 172975	DCP99511
AT163728	DCP99522
AT172975	DCP99511
AT226273	DCP99523
AZ44541	DCP99504
MIA10078	DCP99529
MIA10103	DCP99524
RE 46609	DCP99510
RE12514	DCP99515
RE196923	DCP99528
RE284680	DCP99520
RE46609	DCP99510
RE46609	DCP99525
RE46657	DCP99530
RE55422	DCP99521
RE55422A	DCP99521
RE69716	DCP99510
RE69716	DCP99525
RE70016	DCP99527

KOMATSU	DENSO
14XZ118580	DCP99823
14X-Z11-8580	DCP99823
20Y8101260	DCP99822
20Y81-01260	DCP99822
20Y9793110	DCP99820
20Y-979-3110	DCP99820
20Y9793111	DCP99820
20Y-979-3111	DCP99820
20Y9796121	DCP99820
20Y-979-6121	DCP99820
586303245171	DCP99820
X4436025	DCP99821

KUBOTA	DENSO
3C58150062	DCP99830
3C581-50062	DCP99830
T1065-72213	DCP99831
T2055-72253	DCP99832

LAND ROVER	DENSO
5H3219D623AB	DCP14012
7H3219D623AC	DCP14019
7H32-19D623-AC	DCP14019
8H22-19D623-AA	DCP14013
8H22-19D623-BA	DCP14012
8H2219D623CA	DCP14014
8H22-19D623-CA	DCP14014
AH22-19D629-AA	DCP14020
AWR1458	DCP14005
AWR1459	DCP14004
BTR4717	DCP14002
BTR4719	DCP14003

# A/C Components

## Cross Reference Chart - OE > Short Code

LAND ROVER	DENSO
BTR5750	DCP14001
ERR4375	DCP05010
JPB000020	DCP14007
JPB000030	DCP14008
JPB000040	DCP14018
JPB000040A	DCP14018
JPB000172	DCP14013
JPB000173	DCP14013
JPB000183	DCP14014
JPB010032	DCP24001
JPB10032	DCP24001
JPB101144	DCP24004
JPB101154	DCP14018
JPB101154L	DCP14018
JPB101161	DCP24005
JPB101330	DCP14006
JPB101430	DCP14018
JPB101430A	DCP14018
JPB101450	DCP24004
JPB101450A	DCP24004
JPB101460	DCP24005
JPB101460A	DCP24005
JPB101461	DCP24005
JPB101470	DCP14018
JPB500091	DCP14012
JPB500092	DCP14012
JPB500110	DCP24004
JPB500120	DCP24005
JPB500130	DCP14018
JPB500201	DCP14019
JPB500280	DCP14012
LR01205	DCP14006
LR012593	DCP14013
LR012794	DCP14013
LR012796	DCP14012
LR013841	DCP14020
LR014064	DCP14014
LR014536	DCP14019
LR015151	DCP14012
LR018426	DCP14019
LR018427	DCP14012
LR019134	DCP14012

LEXUS	DENSO
88310-50160	DCP51004
88370-33020	DCP51012
88370-48022	DCP51008

MAZDA	DENSO
F15161450A	DCP44010
F15161K00A	DCP44010

MERCEDES-BENZ	DENSO
0002300011	DCP17008
0002300311	DCP17006
0002300411	DCP17007
0002300511	DCP17010
0002300611	DCP17011
0002301111	DCP17012
0002301211	DCP17013
0002301311	DCP17014
0002301511	DCP17033
0002301611	DCP17015
0002301711	DCP17005
0002301811	DCP17095
0002302011	DCP17023
0002302211	DCP17017
0002302411	DCP17001
0002302511	DCP17003
0002302711	DCP17017
0002303611	DCP17019

MERCEDES-BENZ	DENSO
0002303711	DCP17020
0002303911	DCP17023
0002304211	DCP17021
0002305911	DCP17025
0002306211	DCP17038
0002306511	DCP17026
0002306811	DCP17024
0002307011	DCP17023
0002307611	DCP17080
0002307811	DCP17153
0002307911	DCP17025
000230791187	DCP17025
0002308011	DCP17114
0002308111	DCP17064
0002308511	DCP17026
0002308611	DCP17144
0002308811	DCP17063
0002309011	DCP17026
0002309111	DCP17043
0002309211	DCP17102
0002309311	DCP17051
0002309411	DCP17050
0002309711	DCP17038
0002340128	DCP17C33
0002341312	DCP17039
0002343111	DCP17B35
0002345203	DCP17014
0008302600	DCP17155
0008303100	DCP17156
0012300011	DCP17043
0012300111	DCP17041
0012300211	DCP17085
0012300711	DCP17046
0012300811	DCP17026
0012301011	DCP17039
0012301111	DCP17026
0012301211	DCP17039
0012301311	DCP17102
0012301411	DCP17026
0012301911	DCP17026
0012302011	DCP17059
0012302511	DCP17058
0012302611	DCP17038
0012302811	DCP17064
0012303211	DCP17102
0012303511	DCP17070
0012303611	DCP17071
0012303711	DCP06012
0012304111	DCP17133
0012304411	DCP17146
0012304511	DCP17038
0012304711	DCP17062
0012304811	DCP17058
0012304911	DCP17115
0012305011	DCP17087
0012305111	DCP17128
0012305211	DCP17059
0012305411	DCP17046
0012305411	DCP17068
0012305511	DCP17038
0012305611	DCP17053
0012305711	DCP17067
0012305811	DCP17045
0012306211	DCP17026
0012306911	DCP17121
0012307011	DCP17150
0012307111	DCP17122
0012307911	DCP17067
0012308011	DCP17103
0012308111	DCP17068
0012308211	DCP17059

MERCEDES-BENZ	DENSO
0012308311	DCP17062
0012308411	DCP17058
0012308611	DCP17067
0012308711	DCP17055
0012308811	DCP17063
0012309011	DCP17070
0012309111	DCP17071
0022300511	DCP17065
0022300711	DCP17142
0022301211	DCP17060
0022301311	DCP17070
0022301411	DCP17071
0022301811	DCP17152
0022301911	DCP17072
0022302111	DCP17063
0022302311	DCP17135
0022302911	DCP17158
0022303011	DCP17101
0022303111	DCP17100
0022303211	DCP17104
0022303311	DCP17115
0022303811	DCP17120
0022304411	DCP17112
0022304511	DCP17112
0022304711	DCP17070
0022304811	DCP17071
0022304911	DCP17101
0022305011	DCP17026
0022305111	DCP17105
0022305311	DCP17062
0022305411	DCP17058
0022305511	DCP17055
0022305611	DCP17063
0022305711	DCP17129
0022305811	DCP17138
0022306211	DCP17126
0022306511	DCP17107
0022306611	DCP17026
0022306611	DCP17130
0022306711	DCP17060
0022306811	DCP17106
0022307511	DCP17127
0022307711	DCP17132
0022308011	DCP17139
0022308111	DCP17131
0022308211	DCP17143
0022308411	DCP17112
0022309211	DCP17157
002302111	DCP17025
002302811	DCP17064
002305911	DCP17025
002307211	DCP17144
002308111	DCP17064
002308611	DCP17144
002309111	DCP17043
002341411	DCP17003
0031316801	DCP17013
0031319501	DCP17001
0032302311	DCP17109
0032302911	DCP17148
0032304811	DCP17112
0032308511	DCP17140
0032308711	DCP17154
0032309011	DCP17151
1021300115	DCP17012
1021310001	DCP17012
1101300115	DCP17002
1161300515	DCP17010
1161310001	DCP17003
1191300015	DCP17011
1191300115	DCP17007

MERCEDES-BENZ	DENSO
1192300011	DCP17147
1192300111	DCP17147
1201300215	DCP17006
12300011	DCP17043
12300111	DCP17041
12300211	DCP17085
12300711	DCP17046
12300811	DCP17026
12301011	DCP17039
12301111	DCP17026
12301211	DCP17039
12301311	DCP17102
12301411	DCP17026
12301911	DCP17026
12302011	DCP17059
12302511	DCP17058
12302611	DCP17038
12302811	DCP17064
12303211	DCP17102
12303511	DCP17070
12303611	DCP17071
12303711	DCP06012
12304111	DCP17133
12304411	DCP17146
12304511	DCP17038
12304711	DCP17062
12304811	DCP17058
12304911	DCP17115
12305011	DCP17087
12305111	DCP17128
12305211	DCP17059
12305411	DCP17068
12305511	DCP17038
12305611	DCP17053
12305711	DCP17067
12305811	DCP17045
12306211	DCP17026
12306911	DCP17121
12307011	DCP17150
12307111	DCP17122
12307311	DCP17055
12307411	DCP17063
12307911	DCP17067
12308011	DCP17103
12308111	DCP17068
12308211	DCP17059
12308311	DCP17062
12308311	DCP17146
12308411	DCP17058
12308611	DCP17067
12308711	DCP17055
12308811	DCP17063
12309011	DCP17070
12309111	DCP17071
22300511	DCP17065
22300711	DCP17142
22301211	DCP17060
22301311	DCP17070
22301411	DCP17071
22301811	DCP17152
22301911	DCP17026
22301911	DCP17072
22302111	DCP17063
22302311	DCP17135
22302911	DCP17158
22303011	DCP17101
22303111	DCP17100
22303211	DCP17104
22303311	DCP17115
22303811	DCP17120
22304411	DCP17112

MERCEDES-BENZ	DENSO
22304511	DCP17112
22304711	DCP17070
22304811	DCP17071
22304911	DCP17101
22305011	DCP17026
22305111	DCP17105
22305311	DCP17062
22305411	DCP17058
22305511	DCP17055
22305611	DCP17063
22305711	DCP17129
22305811	DCP17138
22306211	DCP17126
22306311	DCP17164
22306511	DCP17107
22306611	DCP17130
22306711	DCP17060
22306811	DCP17106
22307511	DCP17127
22307711	DCP17132
22308011	DCP17139
22308111	DCP17131
22308211	DCP17143
22308311	DCP17101
22308411	DCP17112
22309211	DCP17157
2300011	DCP17008
2300111	DCP17073
2300311	DCP17006
2300411	DCP17007
2300511	DCP17010
230051187	DCP17010
2300611	DCP17011
2301111	DCP17012
2301211	DCP17013
2301311	DCP17014
23013111	DCP17014
2301511	DCP17033
2301611	DCP17015
2301711	DCP17005
2301811	DCP17095
2302011	DCP17023
2302111	DCP17025
2302211	DCP17017
2302411	DCP17001
2302511	DCP17003
2302611	DCP17002
2302711	DCP17017
2302811	DCP17064
2303611	DCP17019
2303711	DCP17020
2303911	DCP17023
2304211	DCP17021
2305111	DCP17026
2305911	DCP17025
2306211	DCP17038
2306511	DCP17026
2306811	DCP17024
2307011	DCP17023
2307211	DCP17144
2307611	DCP17080
2307811	DCP17153
2307911	DCP17025
230791187	DCP17025
2308011	DCP17114
2308111	DCP17064
2308511	DCP17026
2308611	DCP17144
2308811	DCP17063
2309011	DCP17026
2309111	DCP17043

MERCEDES-BENZ	DENSO
2309211	DCP17102
2309311	DCP17051
2309411	DCP17050
2309711	DCP17038
2340128	DCP17C33
2340811	DCP17033
2340811	DCP17034
2340811	DCP17084
2340811	DCP17092
2340911	DCP17023
2341312	DCP17039
2341411	DCP17003
2343111	DCP17B35
2343711	DCP17B29
31316601	DCP17001
31316801	DCP17013
31318901	DCP17033
31319501	DCP17001
32302311	DCP17109
32302711	DCP17140
32302911	DCP17148
32304811	DCP17112
32307911	DCP17162
32308011	DCP17163
32308511	DCP17140
32308711	DCP17154
32309011	DCP17151
38304160	DCP17168
41311301	DCP17012
4572300111	DCP17113
5412300011	DCP17034
5412300028	DCP17C36
5412300111	DCP17034
5412300211	DCP17036
5412300411	DCP17035
5412300511	DCP17092
5412300611	DCP17036
5412300711	DCP17508
5412300928	DCP17C36
5412301011	DCP17034
5412301111	DCP17092
5412301211	DCP17036
5412301311	DCP17035
5412301411	DCP17K37
5412301511	DCP17K37
6031300215	DCP17013
6161301015	DCP17033
8302100	DCP17166
8302200	DCP17169
8302600	DCP17155
8303100	DCP17156
9062300111	DCP17084
9062300311	DCP17031
9068300260	DCP32068
A0002300011	DCP17008
A0002300311	DCP17006
A0002300411	DCP17007
A0002300511	DCP17010
A000230051187	DCP17010
A0002300611	DCP17011
A0002301111	DCP17012
A0002301211	DCP17013
A0002301311	DCP17014
A0002301511	DCP17033
A0002301611	DCP17015
A0002301711	DCP17005
A0002301811	DCP17095
A0002302011	DCP17023
A0002302111	DCP17025
A0002302211	DCP17017
A0002302411	DCP17001

MERCEDES-BENZ	DENSO
A0002302511	DCP17003
A0002302611	DCP17002
A0002302711	DCP17017
A0002302811	DCP17064
A0002303611	DCP17019
A0002303711	DCP17020
A0002303828	DCP17122
A0002303911	DCP17023
A0002304211	DCP17021
A0002305111	DCP17026
A0002305911	DCP17025
A0002306211	DCP17038
A0002306511	DCP17026
A0002306811	DCP17024
A0002307011	DCP17023
A0002307211	DCP17144
A0002307611	DCP17080
A0002307811	DCP17153
A0002307911	DCP17025
A000230791187	DCP17025
A0002308011	DCP17114
A0002308111	DCP17064
A0002308511	DCP17026
A0002308611	DCP17144
A0002308811	DCP17063
A0002309011	DCP17026
A0002309111	DCP17043
A0002309211	DCP17102
A0002309311	DCP17051
A0002309411	DCP17050
A0002309711	DCP17038
A0002340028	DCP17011
A0002340028	DCP17015
A0002340128	DCP17C33
A0002340811	DCP17033
A0002340811	DCP17034
A0002340811	DCP17084
A0002340811	DCP17092
A0002340911	DCP17023
A0002341312	DCP17039
A0002341312	DCP17102
A0002341411	DCP17003
A0002343111	DCP17B35
A0002343711	DCP17B29
A0002344011	DCP17122
A0002344603	DCP17005
A0002344603	DCP17010
A0002345003	DCP17006
A0002346303	DCP17023
A0002346503	DCP17017
A0008302100	DCP17166
A0008302200	DCP17169
A0008302300	DCP17177
A0008302500	DCP17165
A0008302600	DCP17155
A0008302700	DCP17179
A0008303100	DCP17156
A0008303600	DCP17182
A012300011	DCP17043
A012300111	DCP17041
A012300211	DCP17085
A012300711	DCP17046
A012300811	DCP17026
A012300911	DCP17180
A012301011	DCP17039
A012301111	DCP17026
A012301211	DCP17039
A012301311	DCP17090
A012301311	DCP17102
A012301411	DCP17026
A012301411	DCP17040

MERCEDES-BENZ	DENSO
A0012301611	DCP17160
A0012301911	DCP17026
A0012301911	DCP17119
A0012302011	DCP17059
A0012302511	DCP17058
A0012302611	DCP17038
A0012302611	DCP17108
A0012302811	DCP17064
A0012303211	DCP17102
A0012303511	DCP17070
A0012303611	DCP17071
A0012303711	DCP06012
A0012304111	DCP17133
A0012304411	DCP17146
A0012304511	DCP17038
A0012304711	DCP17062
A0012304811	DCP17058
A0012304911	DCP17115
A0012305011	DCP17087
A0012305111	DCP17128
A0012305211	DCP17059
A0012305411	DCP17068
A0012305511	DCP17038
A0012305611	DCP17053
A0012305711	DCP17067
A0012305811	DCP17045
A0012306211	DCP17026
A0012306911	DCP17121
A0012307011	DCP17150
A0012307111	DCP17122
A0012307311	DCP17055
A0012307411	DCP17063
A0012307911	DCP17067
A0012308011	DCP17103
A0012308111	DCP17068
A0012308211	DCP17059
A0012308311	DCP17062
A0012308411	DCP17058
A0012308611	DCP17067
A0012308711	DCP17055
A0012308811	DCP17063
A0012309011	DCP17070
A0012309111	DCP17071
A0022300511	DCP17065
A0022300711	DCP17142
A0022301111	DCP17143
A0022301211	DCP17060
A0022301311	DCP17070
A0022301411	DCP17071
A0022301811	DCP17152
A0022301911	DCP17072
A0022302111	DCP17063
A0022302311	DCP17135
A0022302911	DCP17158
A0022303011	DCP17101
A0022303111	DCP17100
A0022303211	DCP17104
A0022303311	DCP17115
A0022303811	DCP17120
A0022304411	DCP17112
A0022304511	DCP17112
A0022304711	DCP17070
A0022304811	DCP17071
A0022304911	DCP17101
A0022305011	DCP17026
A0022305111	DCP17105
A0022305311	DCP17062
A0022305411	DCP17058
A0022305511	DCP17055
A0022305611	DCP17063
A0022305711	DCP17129

# A/C Components

## Cross Reference Chart - OE > Short Code

MERCEDES-BENZ	DENSO
A0022305811	DCP17138
A0022306211	DCP17126
A0022306311	DCP17164
A0022306511	DCP17107
A0022306611	DCP17130
A0022306711	DCP17060
A0022306811	DCP17106
A0022307311	DCP17159
A0022307511	DCP17127
A0022307711	DCP17132
A0022308011	DCP17139
A0022308111	DCP17131
A0022308211	DCP17143
A0022308311	DCP17101
A0022308411	DCP17112
A0022309211	DCP17157
A0022309711	DCP17161
A0023013111	DCP17014
A0031316601	DCP17001
A0031316801	DCP17013
A0031318901	DCP17033
A0031319501	DCP17001
A0032302311	DCP17109
A0032302711	DCP17140
A0032302811	DCP17176
A0032302911	DCP17148
A0032304811	DCP17112
A0032306011	DCP17181
A0032307911	DCP17162
A0032308011	DCP17163
A0032308511	DCP17140
A0032308711	DCP17154
A0032308811	DCP17178
A0032309011	DCP17151
A0038304160	DCP17168
A0041311301	DCP17012
A0042300311	DCP17167
A1021300115	DCP17012
A1021310001	DCP17012
A1101300115	DCP17002
A1161300515	DCP17010
A1161310001	DCP17003
A1191300015	DCP17011
A1191300115	DCP17007
A1192300011	DCP17147
A1192300111	DCP17147
A1201300215	DCP17006
A4478307300	DCP17171
A4572300111	DCP17113
A4722300111	DCP17186
A5412300011	DCP17034
A5412300028	DCP17C36
A5412300111	DCP17034
A5412300211	DCP17036
A5412300228	DCP17036
A5412300228	DCP17113
A5412300411	DCP17035
A5412300511	DCP17092
A5412300611	DCP17036
A5412300711	DCP17508
A5412300928	DCP17C36
A5412301011	DCP17034
A5412301111	DCP17092
A5412301211	DCP17036
A5412301311	DCP17035
A5412301411	DCP17K37
A5412301511	DCP17K37
A6031300215	DCP17013
A6161301015	DCP17033
A9062300111	DCP17084
A9062300311	DCP17031

MERCEDES-BENZ	DENSO
A9362300111	DCP17185
HWV0002300111	DCP17073
HWV0002300311	DCP17073
HWV906830026	DCP32068
HWV9068300260	DCP32068
VW9062300111	DCP17084

MINI	DENSO
64536922397	DCP05022

MINI	DENSO
64536922397	DCP05022

MITSUBISHI	DENSO
7813A058	DCP17054
7813A059	DCP17056
7813A084	DCP45004
7813A085	DCP45005
7813A132	DCP45003
7813A162	DCP45006
7813A163	DCP45013
7813A183	DCP45006
7813A184	DCP45013
7813A185	DCP45004
7813A186	DCP45005
7813A190	DCP45006
7813A190	DCP45013
MB918534	DCP45010
MR149370	DCP45010
MR360816	DCP45008
MR360816	DCP45009
MR398533	DCP45012
MR398535	DCP45014
MR500876	DCP45009
MR500877	DCP45011
MR500958	DCP45009
MR513348	DCP45011
MR568289	DCP45009
MR568290	DCP45011
MR568990	DCP17054
S8833-01270	DCP45004
S8833-01270	DCP45005

NISSAN	DENSO
92600 4EA0A	DCP46022
92600 4EBOA	DCP46020
92600 4EFOA	DCP46021
92600-4BE0A	DCP46020
92600-4CA2A	DCP46025
926004PBOA	DCP46024

OPEL	DENSO
1340267	DCP20021K
1854066	DCP20003
1854084	DCP20006
1854096	DCP20004
1854097	DCP20005
1854120	DCP20004
1854121	DCP20005
1854148	DCP20003
5E52754	DCP20022
6340553	DCP20021K
6854000	DCP20004
6854001	DCP20005
6854031	DCP20005
6854091	DCP20021
6854091	DCP20021K
6854093	DCP20022
6854102	DCP20021
6854102	DCP20021K
6854103	DCP20023
6854104	DCP20022
9241681	DCP20006

OPEL-VAUXHALL	DENSO
13427705	DCP20121
13447213	DCP20122
13447214	DCP20120
39006350	DCP20121
39006351	DCP20120
39006352	DCP20122
39006353	DCP20123
39079896	DCP20121
39079897	DCP20120
39079898	DCP20122
39079899	DCP20123
9518237	DCP20122
95518238	DCP20120
95518239	DCP20121

PEUGEOT-CITROËN AUTOMOBILE	DENSO
9810347280	DCP21023
9815198580	DCP21024
9822184980	DCP21025

PORSCHE	DENSO
7P5816803A	DCP28019
7P5820803B	DCP28019
7P5820803D	DCP28019
8T0260805N	DCP02097
8T0260805R	DCP02102
928 126 113 01	DCP28006
944 126 008 00	DCP28001
948 126 011 00	DCP28010
948 126 011 01	DCP28010
948 126 011 02	DCP28014
948 126 011 03	DCP28014
955 126 011 00	DCP32052
955 126 011 12	DCP32022
95B260805B	DCP28018
964 126 121 01	DCP28003
964 126 121 02	DCP28004
970 126 011 02	DCP28017
970 126 011 05	DCP28017
996 126 011 51	DCP28008
996 126 011 52	DCP28008
996 573 926 00	DCP28008
997 126 011 90	DCP28016
9A1 126 011 02	DCP28012
9A1 126 011 05	DCP28012

RENAULT	DENSO
1028683.1	DCP23530
10286831	DCP23530
10327521	DCP23531
1043536.1	DCP23535
10435361	DCP23535
1101155.1	DCP23537
11011550	DCP23537
11011551	DCP23537
5010284917	DCP23002
7700038094	DCP23538
7700038545	DCP23530
7700042614	DCP23531
7700053414	DCP23535
7700053474	DCP23535
7701474008	DCP23025
7711497391	DCP23031
7711497392	DCP23030
7711497568	DCP23032
8200939386	DCP23030
8200956574	DCP23031
8200958328	DCP23032
926000994R	DCP46022
926003370R	DCP23025
926004PBOA	DCP46024

RENAULT	DENSO
926005211R	DCP23034
926008209R	DCP23035
926009944R	DCP23034

SAAB	DENSO
50 48 095	DCP25001
5046891	DCP25001

SEAT	DENSO
034260805B	DCP02001
034260805D	DCP02001
034260808	DCP02001
034260808B	DCP02001
1K0820803A	DCP32003
1K0820803E	DCP32045
1K0820803F	DCP32003
1K0820803G	DCP32045
1K0820803P	DCP32045
1K0820803Q	DCP32045
1K0820803S	DCP32045
1K0820808A	DCP02050
1K0820808AX	DCP02050
1K0820808D	DCP32045
1K0820808DX	DCP32045
1K0820808F	DCP32045
1K0820859C	DCP32045
1K0820859E	DCP32045
1K0820859F	DCP32045
1K0820859H	DCP02050
1K0820859J	DCP02030
1K0820859M	DCP32045
1K0820859N	DCP02030
1K0820859P	DCP02050
1K0820859QX	DCP32045
1K0820859S	DCP32045
1K0820859SX	DCP32045
1K0820859T	DCP02030
1K0820859TX	DCP02030
4E0260805AB	DCP02035
4E0260805AD	DCP02035
4E0260805AJ	DCP02035
4E0260805AP	DCP02035
4E0260805BA	DCP02035
4E0260805C	DCP02091
4E0260805F	DCP02009
4E0260805J	DCP02035
4E0260805N	DCP02035
4F0260805AJ	DCP02090
4F0260805AN	DCP02042
4F0260805AP	DCP02042
5K0820803	DCP02050
5K0820803	DCP32060
5K0820803C	DCP02050
5K0820803C	DCP32060
5K0820803X	DCP02050
5K0820803X	DCP32060
5N0820803C	DCP02050
5N0820803C	DCP32060
5N0820803E	DCP02050
5N0820803G	DCP02050
5N0820803H	DCP32060
5N0820803HX	DCP02050
5N0820803HX	DCP32060
5Q0820803	DCP32060
5Q0820803A	DCP32060
5Q0820803B	DCP32060
5Q0820803C	DCP32060
5Q0820803D	DCP32060
5Q0820803E	DCP32060
5Q0820803F	DCP32060
6Q0820803D	DCP27001

# A/C Components

## Cross Reference Chart - OE > Short Code

SEAT	DENSO
6Q0820803DX	DCP27001
6Q0820803G	DCP27002
6Q0820803GX	DCP27002
6Q0820803H	DCP27001
6Q0820803HX	DCP27001
6Q0820803J	DCP32020
6Q0820803K	DCP32005
6Q0820803P	DCP32020
6Q0820803Q	DCP32005
6Q0820803R	DCP32005
6Q0820808	DCP32020
6Q0820808A	DCP32005
6Q0820808B	DCP32020
6Q0820808C	DCP32005
6Q0820808D	DCP32020
6Q0820808E	DCP32005
6Q0820808F	DCP32020
6Q0820808FX	DCP32020
6Q0820808G	DCP32005
6Q0820808GX	DCP32005
8E0260805AC	DCP02061
8E0260805AK	DCP02039
8E0260805BH	DCP02039
8E0260805BN	DCP02039
8E0260805BP	DCP02041
8E0260805BS	DCP02041
8E0260805CB	DCP02041
8J0260805	DCP02030
8KD260805	DCP02060

SKODA	DENSO
034260805B	DCP02001
034260805D	DCP02001
034260808	DCP02001
034260808B	DCP02001
1K0820803A	DCP32003
1K0820803E	DCP32045
1K0820803F	DCP32003
1K0820803G	DCP32045
1K0820803J	DCP32003
1K0820803P	DCP32045
1K0820803Q	DCP32045
1K0820803S	DCP32045
1K0820808A	DCP02050
1K0820808AX	DCP02050
1K0820808D	DCP32045
1K0820808DX	DCP32045
1K0820808F	DCP32045
1K0820859C	DCP32045
1K0820859E	DCP32045
1K0820859F	DCP32045
1K0820859H	DCP02050
1K0820859J	DCP02030
1K0820859M	DCP32045
1K0820859N	DCP02030
1K0820859P	DCP02050
1K0820859QX	DCP32045
1K0820859S	DCP32045
1K0820859SX	DCP32045
1K0820859T	DCP02030
1K0820859TX	DCP02030
4B0260805B	DCP02005
4B0260805BX	DCP02005
4B0260805C	DCP02004
4B0260805J	DCP02013
4B0260805N	DCP02004
4B0260805P	DCP02004
4B0260805Q	DCP02005
4B0260805R	DCP02004
4B3260805	DCP02005
4D0260805B	DCP02005

SKODA	DENSO
4D0260805C	DCP02004
4D0260808	DCP02005
4E0260805AB	DCP02035
4E0260805AD	DCP02035
4E0260805AJ	DCP02035
4E0260805AP	DCP02035
4E0260805BA	DCP02035
4E0260805C	DCP02091
4E0260805F	DCP02009
4E0260805J	DCP02035
4E0260805N	DCP02035
4F0260805AJ	DCP02090
5K0820803	DCP02050
5K0820803	DCP32060
5K0820803C	DCP02050
5K0820803C	DCP32060
5K0820803X	DCP02050
5K0820803X	DCP32060
5N0820803C	DCP02050
5N0820803C	DCP32060
5N0820803E	DCP02050
5N0820803G	DCP02050
5N0820803G	DCP32060
5N0820803HX	DCP02050
5N0820803HX	DCP32060
5Q0820803	DCP32060
5Q0820803A	DCP32060
5Q0820803B	DCP32060
5Q0820803C	DCP32060
5Q0820803D	DCP32060
5Q0820803E	DCP32060
5Q0820803F	DCP32060
5Q0820803K	DCP32060
6Q0820803G	DCP27002
6Q0820803GX	DCP27002
6Q0820803J	DCP32020
6Q0820803K	DCP32005
6Q0820803P	DCP32020
6Q0820803Q	DCP32005
6Q0820803R	DCP32005
6Q0820808	DCP32020
6Q0820808A	DCP32005
6Q0820808B	DCP32020
6Q0820808C	DCP32005
6Q0820808D	DCP32020
6Q0820808E	DCP32005
6Q0820808F	DCP32020
6Q0820808FX	DCP32020
6Q0820808G	DCP32005
6Q0820808GX	DCP32005
8D0260805B	DCP02006
8D0260805J	DCP02006
8D0260805P	DCP02006
8D0260805Q	DCP02006
8D0260805R	DCP02006
8D0260805RX	DCP02006
8D0260808	DCP02006
8E0260805AC	DCP02061
8E0260805AK	DCP02039
8E0260805BH	DCP02039
8E0260805BN	DCP02039
8J0260805	DCP02030
8KD260805	DCP02060

SMART	DENSO
1222300011	DCP17056
4542300011	DCP17054
4542300111	DCP17054
A1222300011	DCP17056
A4542300011	DCP17054
A4542300111	DCP17054

SUBARU	DENSO
73111AE030	DCP36005
73111-AE030	DCP36005
73111AE080	DCP36006
73111-AE080	DCP36006
73111AG000	DCP36002
73111-AG000	DCP36002
73111AG001	DCP36002
73111-AG001	DCP36002
73111AG010	DCP36003
73111-AG010	DCP36003
73111AG011	DCP36003
73111-AG011	DCP36003
73111AG012	DCP36003
73111-AG012	DCP36003
73111AG020	DCP36004
73111-AG020	DCP36004
73111AG030	DCP36001
73111-AG030	DCP36001
73111AJ020	DCP36004
73111-AJ020	DCP36004
73111CA001	DCP50315
73111-CA011	DCP50315
73111XA010	DCP36007
73111-XA010	DCP36007

SUZUKI	DENSO
095200-65DA0	DCP47003
095200-65DA1	DCP47003
095200-65DC1	DCP47003
095200-65DF1	DCP47003
095200-65DJ0	DCP47004
095200-67D01	DCP47001
095200-67D30	DCP47003
095200-76G21	DCP47002
095200-79JA0	DCP09017
095200-M67D40	DCP47006
095200M-67D40	DCP47006
88320-25140	DCP47001
88320-25140	DCP47006
95200-54PA0	DCP47012
95200-54PA0000	DCP47012
95200-54PB0	DCP47013
95200-54PB0000	DCP47013
95200-55P10	DCP47010
95200-55P10000	DCP47010
95200-61M10	DCP47011
95200-61M10000	DCP47011
95200-62M11	DCP47009
95200-62M11000	DCP47009
95200-62M12	DCP47009
95200-62M12000	DCP47009
95200-65DJ0	DCP47004
95200-67D01	DCP47001
95200-70CJ0	DCP47007
95200-72F00	DCP47008
95200-76G21	DCP47002
95200-79JA0	DCP09017
95201-M79F00	DCP47006
95210-65DA0	DCP47003
95210-65DA0	DCP47004
95210-67D40	DCP47006
95210-76G13	DCP47002
S8832-01820	DCP47003

TOYOTA	DENSO
88310-02180	DCP50015
88310-02181	DCP50011
88310-02182	DCP50011
88310-02190	DCP50013
88310-02191	DCP50013
88310-02192	DCP50013

TOYOTA	DENSO
88310-02251	DCP50011
88310-02261	DCP50013
88310-02262	DCP50013
88310-02270	DCP50010
88310-02320	DCP50011
88310-02330	DCP50013
88310-02340	DCP50010
88310-02370	DCP50302
88310-02390	DCP50300
88310-02400	DCP50301
88310-02450	DCP50302
88310-02480	DCP50301
88310-02500	DCP50302
88310-02540	DCP50306
88310-02650	DCP50302
88310-02680	DCP50302
88310-02690	DCP50228
88310-02720	DCP50305
88310-02780	DCP50310
88310-02790	DCP50312
88310-02800	DCP50319
88310-02830	DCP50308
88310-02840	DCP50309
88310-02850	DCP50313
88310-02851	DCP50313
88310-02852	DCP50313
88310-02891	DCP50313
88310-02A10	DCP50313
88310-02A40	DCP50313
88310-02A60	DCP50313
88310-02A80	DCP50313
88310-05040	DCP50020
88310-05050	DCP50022
88310-05080	DCP50120
88310-05090	DCP50121
88310-05100	DCP50122
88310-05101	DCP50122
88310-05110	DCP50123
88310-05120	DCP50124
88310-05140	DCP50228
88310-06130	DCP50040
88310-06140	DCP50040
88310-06150	DCP50040
88310-06160	DCP50040
88310-06170	DCP50040
88310-06240	DCP50042
88310-06360	DCP50042
88310-06420	DCP50042
88310-0D010	DCP50001
88310-0D070	DCP50009
88310-0D071	DCP50009
88310-0D090	DCP50004
88310-0D091	DCP50004
88310-0D120	DCP50002
88310-0D140	DCP50001
88310-0D141	DCP50001
88310-0D180	DCP50004
88310-0D200	DCP50246
88310-0D201	DCP50246
88310-0D202	DCP50246
88310-0D210	DCP50248
88310-0D211	DCP50248
88310-0D212	DCP50248
88310-0D230	DCP50240
88310-0D231	DCP50240
88310-0D241	DCP50249
88310-0D280	DCP50249
88310-0D300	DCP50249
88310-0D320	DCP50304
88310-0D330	DCP50305

# A/C Components

## Cross Reference Chart - OE > Short Code

TOYOTA	DENSO
88310-0D380	DCP50251
88310-0D400	DCP50252
88310-0D410	DCP50253
88310-0D420	DCP50250
88310-0DA80	DCP50317
88310-0DA90	DCP50318
88310-0F010	DCP50114
88310-0F020	DCP50122
88310-0F021	DCP50122
88310-0F030	DCP50124
88310-0F050	DCP50314
88310-0G020	DCP50087
88310-0K110	DCP50092
88310-0K111	DCP50092
88310-0K112	DCP50092
88310-0K113	DCP50092
88310-0K130	DCP50093
88310-0K131	DCP50093
88310-0K132	DCP50093
88310-0K190	DCP50092
88310-0K191	DCP50092
88310-0K192	DCP50092
88310-0N010	DCP51002
88310-0R011	DCP50101
88310-0R012	DCP50101
88310-0R013	DCP50101
88310-0R014	DCP50101
88310-0R030	DCP50039
88310-13030	DCP50013
88310-13032	DCP50013
88310-1A523	DCP50012
88310-1A580	DCP50015
88310-1A582	DCP50011
88310-1A620	DCP50010
88310-1A660	DCP50302
88310-1A680	DCP50300
88310-1A760	DCP50306
88310-1A770	DCP50228
88310-1A800	DCP50304
88310-1A820	DCP50305
88310-1A840	DCP50312
88310-1A841	DCP50312
88310-25220	DCP50095
88310-28450	DCP50081
88310-28530	DCP50082
88310-28540	DCP50226
88310-28550	DCP50080
88310-2B301	DCP50050
88310-2B470	DCP50050
88310-2B550	DCP50023
88310-2B560	DCP50024
88310-2B590	DCP50021
88310-2B640	DCP50025
88310-2B660	DCP50026
88310-2B680	DCP50060
88310-2B720	DCP50242
88310-2B721	DCP50242
88310-33220	DCP50041
88310-33250	DCP50042
88310-35710	DCP50078
88310-35850	DCP50097
88310-36212	DCP50100
88310-36530	DCP50099
88310-36881	DCP50100
88310-3A430	DCP51002
88310-3A431	DCP51002
88310-3A433	DCP51002
88310-42070	DCP50031
88310-42180	DCP50033
88310-42200	DCP50030
88310-42210	DCP50032
88310-42250	DCP50301

TOYOTA	DENSO
88310-42260	DCP50035
88310-42270	DCP50039
88310-42310	DCP50037
88310-42320	DCP50036
88310-42331	DCP50101
88310-42332	DCP50101
88310-42333	DCP50101
88310-42334	DCP50101
88310-42370	DCP50311
88310-42510	DCP50313
88310-42511	DCP50313
88310-42520	DCP50311
88310-44140	DCP50090
88310-44150	DCP50220
88310-44160	DCP50221
88310-44170	DCP50222
88310-44180	DCP50223
88310-44200	DCP50224
88310-44210	DCP50225
88310-44220	DCP50083
88310-48040	DCP50040
88310-50150	DCP51003
88310-50151	DCP51003
88310-50152	DCP51003
88310-52020	DCP50115
88310-52070	DCP50115
88310-52141	DCP50005
88310-52220	DCP50006
88310-52340	DCP50002
88310-52341	DCP50002
88310-52350	DCP50116
88310-52351	DCP50007
88310-52371	DCP50003
88310-52380	DCP50006
88310-52381	DCP50006
88310-52400	DCP50004
88310-52401	DCP50004
88310-52421	DCP50005
88310-52481	DCP50245
88310-52492	DCP50241
88310-52550	DCP50249
88310-52551	DCP50249
88310-52590	DCP50240
88310-52591	DCP50240
88310-52592	DCP50240
88310-52600	DCP50243
88310-52601	DCP50243
88310-52710	DCP50251
88310-52730	DCP50252
88310-53040	DCP51000
88310-53060	DCP51001
88310-60460	DCP50070
88310-60770	DCP50071
88310-60850	DCP50087
88310-60851	DCP50087
88310-63020	DCP50020
88310-68010	DCP50120
88310-6A010	DCP50073
88310-6A060	DCP50086
88310-6A100	DCP50074
88310-6A140	DCP50085
88310-6A141	DCP50076
88310-6A350	DCP50088
88310-6A390	DCP50131
88310-71060	DCP50092
88310-71061	DCP50092
88310-71062	DCP50092
88310-74010	DCP50125
88310-74012	DCP50125
88310-74021	DCP50125
88310-74022	DCP50125

TOYOTA	DENSO
88310-74031	DCP50126
88310-74032	DCP50126
88310-97405	DCP49002
88310-B2220	DCP99017
88320-0K100	DCP50093
88320-0K460	DCP50092
88320-0K500	DCP50092
88320-1A470	DCP50014
88320-1A481	DCP50011
88320-1A481	DCP50013
88320-1A491	DCP50012
88320-1A550	DCP50013
88320-25110	DCP50095
88320-28350	DCP50081
88320-28370	DCP50226
88320-28371	DCP50226
88320-28410	DCP50080
88320-2B300	DCP50050
88320-2B350	DCP50023
88320-2B360	DCP50024
88320-2B400	DCP50021
88320-2B410	DCP50026
88320-2B420	DCP50060
88320-2BH90	DCP50024
88320-35470	DCP50078
88320-35720	DCP50097
88320-35730	DCP50130
88320-36560	DCP50100
88320-3A250	DCP51002
88320-3A300	DCP51002
88320-42050	DCP50031
88320-42080	DCP50033
88320-42100	DCP50030
88320-42110	DCP50032
88320-44100	DCP50090
88320-44120	DCP50220
88320-44130	DCP50221
88320-44130	DCP50224
88320-44140	DCP50222
88320-44140	DCP50225
88320-44150	DCP50083
88320-44150	DCP50223
88320-48080	DCP50040
88320-48080	DCP50041
88320-52010	DCP50115
88320-52080	DCP50004
88320-52080	DCP50005
88320-52090	DCP50006
88320-52120	DCP50116
88320-52130	DCP50002
88320-52370	DCP50004
88320-52400	DCP50007
88320-52420	DCP50010
88320-52430	DCP50002
88320-52430	DCP50003
88320-53020	DCP51000
88320-60630	DCP50071
88320-60680	DCP50087
88320-60681	DCP50087
88320-60700	DCP50073
88320-60720	DCP50074
88320-63010	DCP50020
88320-63020	DCP50022
88320-6A080	DCP50085
88320-6A081	DCP50076
88320-6A090	DCP50086
88320-6A320	DCP50088
88320-6A460	DCP50131
88320-6A470	DCP50132
88320-71110	DCP50092
88320-74010	DCP50125

TOYOTA	DENSO
88320-74030	DCP50126
88320-74050	DCP50125
88320-97209	DCP49002
88320-B2070	DCP99017
88370-30020	DCP51005
88370-30021	DCP51005
88370-30030	DCP51006
88370-33020	DCP51012
88370-47010	DCP50503
88370-47030	DCP50502
88370-47031	DCP50502
88370-47032	DCP50502
88370-47050	DCP51010
88370-47060	DCP50501
88370-48030	DCP51007
88370-52010	DCP50504
88370-52011	DCP50504
88370-52012	DCP50504
88370-76020	DCP51011
88410-05010	DCP50022
88410-0K210	DCP50093
88410-0K400	DCP50092
88410-0K450	DCP50093
88410-0K470	DCP50092
88410-0K520	DCP50093
88410-13010	DCP50013
88410-13020	DCP50013
88410-13030	DCP50013
88410-17110	DCP99524
88410-1A220	DCP50015
88410-1A260	DCP50011
88410-1A290	DCP50011
88410-1A320	DCP36003
88410-1A330	DCP50010
88410-21020	DCP50021
88410-22480	DCP50071
88410-28200	DCP50095
88410-28230	DCP50222
88410-28230	DCP50223
88410-28260	DCP50226
88410-2B060	DCP50024
88410-2B100	DCP50050
88410-2B240	DCP50023
88410-32200	DCP50060
88410-33090	DCP50025
88410-35250	DCP50078
88410-35390	DCP50097
88410-35400	DCP50076
88410-35400	DCP50080
88410-35400	DCP50085
88410-35400	DCP50130
88410-35410	DCP50086
88410-36520	DCP50100
88410-3A280	DCP51002
88410-3A290	DCP51002
88410-42040	DCP50040
88410-42060	DCP50032
88410-42070	DCP50030
88410-42080	DCP50033
88410-42080	DCP50041
88410-44010	DCP50031
88410-44050	DCP50026
88410-44060	DCP50090
88410-44080	DCP50083
88410-44080	DCP50225
88410-50040	DCP50087
88410-52030	DCP50115
88410-52080	DCP50006
88410-52150	DCP50002
88410-52230	DCP50007
88410-52240	DCP50006

# A/C Components

## Cross Reference Chart - OE > Short Code

TOYOTA	DENSO
88410-52250	DCP50004
88410-52260	DCP50002
88410-52290	DCP50005
88410-53010	DCP51000
88410-60410	DCP50087
88410-6A010	DCP50073
88410-6A010	DCP50074
88410-6A100	DCP50088
88410-6A180	DCP50131
88410-6A180	DCP50132
88410-71050	DCP50092
88410-74010	DCP50125
88410-74020	DCP50126
88410-74040	DCP50125
88410-97212	DCP49002
88410-B1010	DCP36001
88410-B1040	DCP99017

TOYOTA/LEXUS	DENSO
88310-02B00	DCP50316
88310-02B10	DCP50316
88310-35830	DCP50103
88310-35870	DCP50102
88310-48011	DCP51015
88310-48180	DCP51016
88320-35700	DCP50103
88410-35430	DCP50103
SU003-02115	DCP50315

VAG	DENSO
2H0820803A	DCP32074
4G0260805AB	DCP02110
4G0260805AD	DCP02110
4G0260805F	DCP02108
4G0260805M	DCP02110
4G0260805N	DCP02109
4H0260805H	DCP02107
4M0816803	DCP02106
4M0820803	DCP02106
5K0820803CX	DCP02050
5K0820803CX	DCP32060
5Q0816803	DCP32080
5Q0816803B	DCP32080
5Q0816803D	DCP32080
5Q0816803E	DCP32080
5Q0816803F	DCP32080
5Q0820803J	DCP32060
5Q0820803K	DCP32060
7E0816803C	DCP32075
7E0816803D	DCP32076
7E0820803P	DCP32077
8W5816803	DCP02106
8W5820803A	DCP02106

VALTRA	DENSO
ACV0059750	DCP99526

VDL	DENSO
30041819	DCP99023

VOLKSWAGEN	DENSO
034260805B	DCP02001
034260805D	DCP02001
034260808	DCP02001
034260808B	DCP02001
070903201E	DCP32006K
070903327D	DCP32006K
1K0820803A	DCP32003
1K0820803E	DCP32045
1K0820803F	DCP32002
1K0820803F	DCP32003

VOLKSWAGEN	DENSO
1K0820803G	DCP32045
1K0820803J	DCP32003
1K0820803N	DCP32045
1K0820803P	DCP32045
1K0820803Q	DCP32045
1K0820803S	DCP32045
1K0820808A	DCP02050
1K0820808AX	DCP02050
1K0820808D	DCP32045
1K0820808DX	DCP32045
1K0820808F	DCP32045
1K0820808FX	DCP32045
1K0820812B	DCP02030
1K0820812B	DCP32045
1K0820859C	DCP32045
1K0820859E	DCP32045
1K0820859F	DCP32045
1K0820859H	DCP02050
1K0820859J	DCP02030
1K0820859M	DCP32045
1K0820859N	DCP02030
1K0820859P	DCP02050
1K0820859Q	DCP32045
1K0820859QX	DCP32045
1K0820859S	DCP32045
1K0820859SX	DCP32045
1K0820859T	DCP02030
1K0820859TX	DCP02030
2E0820803B	DCP17073
2E0820803C	DCP17073
2E0820803D	DCP17073
2E0820803DH	DCP17084
2E0820803G	DCP17073
2E0820803H	DCP32068
2E0820803J	DCP32068
2E0820805	DCP32067
34260805A	DCP02002
34260805B	DCP02001
34260805C	DCP02002
34260805D	DCP02001
34260808	DCP02001
34260808A	DCP02002
34260808B	DCP02001
34260808C	DCP02002
3B0820803C	DCP32052
3B0820803CX	DCP32052
3D0820803A	DCP32021
3D0820803B	DCP32021
3D0820803G	DCP32021
3D0820803H	DCP32021
3D0820803J	DCP32021
3D0820803M	DCP32021
3D0820803P	DCP32021
3D0820803T	DCP32021
3D0820805B	DCP32006
3D0820805B	DCP32006K
3D0820805C	DCP32021
3D0820805Q	DCP32006
420260805A	DCP02104
4B0260805B	DCP02005
4B0260805BX	DCP02005
4B0260805C	DCP02004
4B0260805J	DCP02013
4B0260805N	DCP02004
4B0260805P	DCP02004
4B0260805PX	DCP02004
4B0260805Q	DCP02005
4B0260805R	DCP02004
4B3260805	DCP02005
4D0260805B	DCP02005
4D0260805C	DCP02004

VOLKSWAGEN	DENSO
4D0260808	DCP02005
4E0260805AB	DCP02035
4E0260805AD	DCP02035
4E0260805AJ	DCP02035
4E0260805AP	DCP02035
4E0260805BA	DCP02035
4E0260805C	DCP02091
4E0260805F	DCP02009
4E0260805J	DCP02035
4E0260805N	DCP02035
4F0260805AD	DCP02015
4F0260805AH	DCP02015
4F0260805AJ	DCP02090
4F0260805E	DCP02015
4F0260805L	DCP02015
4G0260805A	DCP02103
4G0260805D	DCP32061
4H0260805E	DCP02095
4H0260805F	DCP32071
4L0820803	DCP32063
5K0820803	DCP02050
5K0820803	DCP32060
5K0820803C	DCP02050
5K0820803C	DCP32060
5K0820803CX	DCP02050
5K0820803CX	DCP32060
5K0820803X	DCP02050
5K0820803X	DCP32060
5N0820803	DCP02050
5N0820803	DCP32060
5N0820803A	DCP02050
5N0820803A	DCP32060
5N0820803E	DCP02050
5N0820803F	DCP32056
5N0820803H	DCP32060
5Q0820803	DCP32060
5Q0820803A	DCP32060
5Q0820803B	DCP32060
5Q0820803C	DCP32060
5Q0820803D	DCP32060
5Q0820803E	DCP32060
5Q0820803F	DCP32060
5Q0820803G	DCP32060
5Q0820803H	DCP32060
5Q0820803I	DCP32060
5Q0820803J	DCP32060
5Q0820803K	DCP32060
5Q0820803L	DCP32060
5Q0820803M	DCP32060
5Q0820803N	DCP32060
5Q0820803P	DCP32060
5Q0820803Q	DCP32060
5Q0820803R	DCP32060
5Q0820803S	DCP32060
5Q0820803T	DCP32060
5Q0820803U	DCP32060
5Q0820803V	DCP32060
5Q0820803W	DCP32060
5Q0820803X	DCP32060
5Q0820803Y	DCP32060
5Q0820803Z	DCP32060
6Q0820803DX	DCP27001
6Q0820803G	DCP27002
6Q0820803GX	DCP27002
6Q0820803H	DCP27001
6Q0820803HX	DCP27001
6Q0820803J	DCP32020
6Q0820803K	DCP32005
6Q0820803P	DCP32020
6Q0820803Q	DCP32005
6Q0820803R	DCP32005
6Q0820808	DCP32020
6Q0820808A	DCP32005
6Q0820808B	DCP32020
6Q0820808C	DCP32005
6Q0820808D	DCP32020
6Q0820808E	DCP32005
6Q0820808F	DCP32020
6Q0820808FX	DCP32020
6Q0820808G	DCP32005
6Q0820808GX	DCP32005
7E0820803	DCP32050
7E0820803A	DCP32069
7E0820803D	DCP32070
7E0820803E	DCP32066
7E0820803F	DCP32070
7E0820803G	DCP32066
7E0820803H	DCP32072
7E0820803J	DCP32065

VOLKSWAGEN	DENSO
7E0820803N	DCP32073
7H0820805	DCP32006
7H0820805	DCP32006K
7H0820805A	DCP32006
7H0820805A	DCP32006K
7H0820805B	DCP32006
7H0820805B	DCP32006K
7H0820805C	DCP32006
7H0820805C	DCP32006K
7H0820805E	DCP32006
7H0820805E	DCP32006K
7H0820805F	DCP32006
7H0820805F	DCP32006K
7H0820805G	DCP32006
7H0820805G	DCP32006K
7H0820805H	DCP32006
7H0820805H	DCP32006K
7H0820805J	DCP32006
7H0820805J	DCP32006K
7L5820803	DCP28010
7L5820803A	DCP28010
7L6820803A	DCP32023
7L6820803B	DCP32023
7L6820803C	DCP32022
7L6820803D	DCP32031
7L6820803E	DCP32051
7L6820803F	DCP32022
7L6820803G	DCP32031
7L6820803H	DCP32051
7L6820803J	DCP32022
7L6820803K	DCP32022
7L6820803L	DCP32031
7L6820803M	DCP32022
7L6820803P	DCP32031
7L6820803Q	DCP32022
7L6820803R	DCP32051
7L6820803S	DCP32031
7L6820803T	DCP32022
7L6820808	DCP02096
7P0820803D	DCP32022
7P0820803E	DCP32031
7P0820803E	DCP32055
7P0820803F	DCP32064
7P0820803L	DCP32064
7P0820803M	DCP32031
7P0820803N	DCP32022
7P6820803B	DCP32071
8D0260805B	DCP02006
8D0260805C	DCP32001
8D0260805J	DCP02006
8D0260805K	DCP32001
8D0260805L	DCP32001
8D0260805P	DCP02006
8D0260805Q	DCP02006
8D0260805R	DCP02006
8D0260805RX	DCP02006
8D0260808	DCP02006
8E0260805AC	DCP02061
8E0260805AK	DCP02039
8E0260805BH	DCP02039
8E0260805BN	DCP02039
8E0260805CC	DCP02052
8E0260805CG	DCP02052
8J0260805	DCP02030
8J0260805A	DCP02030
8K0260805M	DCP32061
8K260805	DCP02060
8T0260805G	DCP02105
8T0260805Q	DCP02105
A0012307911	DCP17086



# A/C Components

Cross Reference Chart - Short Code > OE

DCP01001	OE
FIAT	46336396
FIAT	46536396
FIAT	46775094
FIAT	50503374
FIAT	60814101
FIAT	60815796
FIAT	60816191
FIAT	71721731
FIAT	71781765

DCP01004	OE
FIAT	77384720

DCP01015	OE
FIAT	51815102

DCP02001	OE
AUDI	034260805B
AUDI	034260805D
AUDI	034260808
AUDI	034260808B
SEAT	034260805B
SEAT	034260805D
SEAT	034260808
SEAT	034260808B
SKODA	034260805B
SKODA	034260805D
SKODA	034260808
SKODA	034260808B
VOLKSWAGEN	034260805B
VOLKSWAGEN	034260805D
VOLKSWAGEN	034260808
VOLKSWAGEN	034260808B
VOLKSWAGEN	34260805B
VOLKSWAGEN	34260805D
VOLKSWAGEN	34260808
VOLKSWAGEN	34260808B

DCP02002	OE
AUDI	034260805A
AUDI	034260805C
AUDI	034260808A
AUDI	034260808C
VOLKSWAGEN	34260805A
VOLKSWAGEN	34260805C
VOLKSWAGEN	34260808A
VOLKSWAGEN	34260808C

DCP02003	OE
AUDI	77260803A
AUDI	77260803C

DCP02004	OE
AUDI	4B0260805C
AUDI	4B0260805N
AUDI	4B0260805P
AUDI	4B0260805R
AUDI	4D0260805C
SKODA	4B0260805C
SKODA	4B0260805N
SKODA	4B0260805P
SKODA	4B0260805R
SKODA	4D0260805C
VOLKSWAGEN	4B0260805C
VOLKSWAGEN	4B0260805N
VOLKSWAGEN	4B0260805P
VOLKSWAGEN	4B0260805R
VOLKSWAGEN	4D0260805C

DCP02005	OE
AUDI	4B0260805B
AUDI	4B0260805BX
AUDI	4B0260805Q
AUDI	4B3260805
AUDI	4D0260805B
AUDI	4D0260808
SKODA	4B0260805B
SKODA	4B0260805BX
SKODA	4B0260805Q
SKODA	4B3260805
SKODA	4D0260805B
SKODA	4D0260808
VOLKSWAGEN	4B0260805B
VOLKSWAGEN	4B0260805BX
VOLKSWAGEN	4B0260805Q
VOLKSWAGEN	4B3260805
VOLKSWAGEN	4D0260805B
VOLKSWAGEN	4D0260808

DCP02006	OE
AUDI	8D0260805B
AUDI	8D0260805J
AUDI	8D0260805P
AUDI	8D0260805Q
AUDI	8D0260805R
AUDI	8D0260805RX
AUDI	8D0260808
SKODA	8D0260805B
SKODA	8D0260805J
SKODA	8D0260805P
SKODA	8D0260805Q
SKODA	8D0260805R
SKODA	8D0260805RX
SKODA	8D0260808
VOLKSWAGEN	8D0260805B
VOLKSWAGEN	8D0260805J
VOLKSWAGEN	8D0260805P
VOLKSWAGEN	8D0260805Q
VOLKSWAGEN	8D0260805R
VOLKSWAGEN	8D0260805RX
VOLKSWAGEN	8D0260808

DCP02007	OE
AUDI	8Z0260805
AUDI	8Z0260805A

DCP02008	OE
AUDI	8E0260805C

DCP02009	OE
AUDI	4E0260805F
SEAT	4E0260805F
SKODA	4E0260805F
VOLKSWAGEN	4E0260805F

DCP02010	OE
AUDI	8E0260805
AUDI	8E0260805AB
AUDI	8E0260805M
AUDI	8E0260805N

DCP02011	OE
AUDI	4B0260805G
AUDI	4B0260805K
AUDI	4B0260805M

DCP02012	OE
AUDI	8E0260805AF

DCP02013	OE
AUDI	4B0260805J

DCP02013	OE
SKODA	4B0260805J
VOLKSWAGEN	4B0260805J

DCP02014	OE
AUDI	4F0260805G
AUDI	4F0260805M
AUDI	4F0260805P

DCP02015	OE
AUDI	400260805B
AUDI	4E0260805AM
AUDI	4E0260805AS
AUDI	4E0260805Q
AUDI	4F0260805AD
AUDI	4F0260805AH
AUDI	4F0260805L
AUDI	4Z7260805E
AUDI	8K0260805B
AUDI	8K0260805H
VOLKSWAGEN	4F0260805AD
VOLKSWAGEN	4F0260805AH
VOLKSWAGEN	4F0260805E
VOLKSWAGEN	4F0260805L

DCP02016	OE
AUDI	4F0260805D
AUDI	4F0260805F
AUDI	4F0260805K
AUDI	4F0260805Q

DCP02022	OE
AUDI	4E0260805E

DCP02023	OE
AUDI	8E0260805R

DCP02024	OE
AUDI	8E0260805AH

DCP02025	OE
AUDI	4E0260805E
AUDI	8E0260805S

DCP02026	OE
AUDI	8E0260805T

DCP02027	OE
AUDI	8E0260805AJ

DCP02028	OE
AUDI	8E0260805AS

DCP02030	OE
AUDI	1K0820859J
AUDI	1K0820859N
AUDI	1K0820859T
AUDI	1K0820859TX
SEAT	8J0260805
SEAT	1K0820859J
SEAT	1K0820859N
SEAT	1K0820859T
SEAT	1K0820859TX
SEAT	8J0260805
SKODA	1K0820859J
SKODA	1K0820859N
SKODA	1K0820859T
SKODA	1K0820859TX
SKODA	8J0260805
VOLKSWAGEN	1K0820812B
VOLKSWAGEN	1K0820859J
VOLKSWAGEN	1K0820859N

DCP02030	OE
VOLKSWAGEN	1K0820859T
VOLKSWAGEN	1K0820859TX
VOLKSWAGEN	8J0260805
VOLKSWAGEN	8J0260805A

DCP02031	OE
AUDI	4E0260805AR

DCP02032	OE
AUDI	4E0260805AG

DCP02033	OE
AUDI	4E0260805AA
AUDI	4E0260805AL
AUDI	4E0260805AR
AUDI	4F0260805AR
AUDI	8E0260805BD
AUDI	8E0260805BG
AUDI	8E0260805BK
AUDI	8E0260805BT
AUDI	8E0260805CE

DCP02034	OE
AUDI	4E0260805AC
AUDI	4E0260805AG
AUDI	4E0260805G
AUDI	4H0260805
AUDI	4H0260805A
AUDI	8E0260805BM
AUDI	8H0260805B

DCP02035	OE
AUDI	4E0260805AB
AUDI	4E0260805AD
AUDI	4E0260805AJ
AUDI	4E0260805AP
AUDI	4E0260805BA
AUDI	4E0260805J
AUDI	4E0260805N
SEAT	4E0260805AB
SEAT	4E0260805AD
SEAT	4E0260805AJ
SEAT	4E0260805AP
SEAT	4E0260805BA
SEAT	4E0260805J
SEAT	4E0260805N
SKODA	4E0260805AB
SKODA	4E0260805AD
SKODA	4E0260805AJ
SKODA	4E0260805AP
SKODA	4E0260805BA
SKODA	4E0260805J
SKODA	4E0260805N
VOLKSWAGEN	4E0260805AB
VOLKSWAGEN	4E0260805AD
VOLKSWAGEN	4E0260805AJ
VOLKSWAGEN	4E0260805AP
VOLKSWAGEN	4E0260805BA
VOLKSWAGEN	4E0260805J
VOLKSWAGEN	4E0260805N

DCP02036	OE
AUDI	4F0260805AB
AUDI	4F0260805AF
AUDI	4F0260805H
AUDI	4F0260805R

DCP02037	OE
AUDI	4F0260805AC
AUDI	4F0260805AG
AUDI	4F0260805J

DCP02037	OE
AUDI	4F0260805N
AUDI	4F0260805S

DCP02038	OE
AUDI	8E0260805AG
AUDI	8E0260805AT
AUDI	8E0260805BA
AUDI	8E0260805BE
AUDI	8E0260805BF
AUDI	8E0260805BJ
AUDI	8E0260805BL
AUDI	8E0260805CA

DCP02039	OE
AUDI	8E0260805AK
AUDI	8E0260805BH
AUDI	8E0260805BN
SEAT	8E0260805AK
SEAT	8E0260805BH
SEAT	8E0260805BN
SKODA	8E0260805AK
SKODA	8E0260805BH
SKODA	8E0260805BN
VOLKSWAGEN	8E0260805AK
VOLKSWAGEN	8E0260805BH
VOLKSWAGEN	8E0260805BN

DCP02040	OE
AUDI	4F0260805AA
AUDI	4F0260805AE
AUDI	4F0260805T

DCP02041	OE
AUDI	8E0260805BP
AUDI	8E0260805BS
AUDI	8E0260805CB
SEAT	8E0260805BP
SEAT	8E0260805BS
SEAT	8E0260805CB

DCP02042	OE
AUDI	4F0260805AL
AUDI	4F0260805AN
AUDI	4F0260805AP
AUDI	8K0260805
AUDI	8K0260805E
AUDI	8K0260805L
SEAT	4F0260805AN
SEAT	4F0260805AP

DCP02043	OE
AUDI	8E0260805BC
AUDI	8K0260805A
AUDI	8K0260805D
AUDI	8K0260805G
AUDI	8K0260805K

DCP02044	OE
AUDI	8K0260805C
AUDI	8K0260805F
AUDI	8K0260805P

DCP02045	OE
AUDI	8E0260805F

DCP02046	OE
AUDI	4B0260805H

DCP02047	OE
AUDI	4Z0260805
AUDI	4Z7260805

DCP02048	OE
AUDI	8E0260805G

DCP02050	OE
AUDI	1K0820808A
AUDI	1K0820808AX
AUDI	1K0820859H
AUDI	1K0820859P
AUDI	5K0820803
AUDI	5K0820803C
AUDI	5K0820803X
AUDI	5N0820803B
AUDI	5N0820803C
AUDI	5N0820803E
AUDI	5N0820803G
AUDI	5N0820803HX
SEAT	1K0820808A
SEAT	1K0820808AX
SEAT	1K0820859H
SEAT	1K0820859P
SEAT	5K0820803
SEAT	5K0820803C
SEAT	5K0820803X
SEAT	5N0820803B
SEAT	5N0820803C
SEAT	5N0820803E
SEAT	5N0820803G
SEAT	5N0820803HX
SKODA	1K0820808A
SKODA	1K0820808AX
SKODA	1K0820859H
SKODA	1K0820859P
SKODA	5K0820803
SKODA	5K0820803C
SKODA	5K0820803X
SKODA	5N0820803B
SKODA	5N0820803C
SKODA	5N0820803E
SKODA	5N0820803G
SKODA	5N0820803HX
VAG	5K0820803CX
VOLKSWAGEN	1K0820808A
VOLKSWAGEN	1K0820808AX
VOLKSWAGEN	1K0820859H
VOLKSWAGEN	1K0820859P
VOLKSWAGEN	5K0820803
VOLKSWAGEN	5K0820803C
VOLKSWAGEN	5K0820803X
VOLKSWAGEN	5K0820803CX
VOLKSWAGEN	5K0820803C
VOLKSWAGEN	5K0820803X
VOLKSWAGEN	5N0820803
VOLKSWAGEN	5N0820803A
VOLKSWAGEN	5N0820803E

DCP02052	OE
AUDI	8E0260805BQ
AUDI	8E0260805BR
AUDI	8E0260805CC
AUDI	8E0260805CG
VOLKSWAGEN	8E0260805CC
VOLKSWAGEN	8E0260805CG

DCP02055	OE
AUDI	4F0260805E
AUDI	4Z7260805D
AUDI	4Z7260805F

DCP02060	OE
AUDI	8K0260805
SEAT	8K0260805
SKODA	8K0260805
VOLKSWAGEN	8K0260805

DCP02061	OE
AUDI	8E0260805AC

DCP02061	OE
SEAT	8E0260805AC
SKODA	8E0260805AC
VOLKSWAGEN	8E0260805AC

DCP02063	OE
AUDI	4E0260805AK
AUDI	4E0260805AQ
AUDI	4E0260805BC

DCP02064	OE
AUDI	8K0260805H

DCP02065	OE
AUDI	8E0260805CD

DCP02090	OE
AUDI	4F0260805AJ
SEAT	4F0260805AJ
SKODA	4F0260805AJ
VOLKSWAGEN	4F0260805AJ

DCP02091	OE
AUDI	4E0260805C
SEAT	4E0260805C
SKODA	4E0260805C
VOLKSWAGEN	4E0260805C

DCP02092	OE
AUDI	8K0260805J

DCP02095	OE
VOLKSWAGEN	4H0260805E

DCP02096	OE
VOLKSWAGEN	7L6820808

DCP02097	OE
AUDI	8T0260805E
AUDI	8T0260805N
PORSCHE	8T0260805N

DCP02098	OE
AUDI	8T0260805F
AUDI	8T0260805P
AUDI	8T0260805S

DCP02099	OE
AUDI	4G0260805B

DCP02101	OE
AUDI	8K0260805N
AUDI	8K0260805Q

DCP02102	OE
AUDI	8T0260805H
AUDI	8T0260805R
PORSCHE	8T0260805R

DCP02103	OE
VOLKSWAGEN	4G0260805A

DCP02104	OE
VOLKSWAGEN	420260805A

DCP02105	OE
VOLKSWAGEN	8T0260805G
VOLKSWAGEN	8T0260805Q

DCP02106	OE
VAG	4M0816803
VAG	4M0820803

DCP02106	OE
VAG	8W5816803
VAG	8W5820803A

DCP02107	OE
VAG	4H0260805H

DCP02108	OE
VAG	4G0260805F

DCP02109	OE
VAG	4G0260805N

DCP02110	OE
VAG	4G0260805AB
VAG	4G0260805AD
VAG	4G0260805M

DCP05001	OE
BMW	64528390743

DCP05003	OE
BMW	64521385161
BMW	64528385161
BMW	64528385915
BMW	64528390741
BMW	64528391694

DCP05004	OE
BMW	64528391135

DCP05006	OE
BMW	64528390964

DCP05007	OE
BMW	64528391693

DCP05008	OE
BMW	64528385917
BMW	64528391880

DCP05009	OE
BMW	64528367983

DCP05010	OE
BMW	64528371021
BMW	64528391695
LAND ROVER	ERR4375

DCP05012	OE
BMW	64521369418
BMW	64528363551

DCP05013	OE
BMW	64528377242
BMW	64528385050

DCP05014	OE
BMW	64526904018
BMW	64526910458
BMW	64526910459
BMW	64526911341
BMW	64528377241
BMW	64528379924
BMW	64528386451

DCP05016	OE
BMW	64526904015
BMW	64526910460
BMW	64526911342
BMW	64528377244
BMW	64528381233

# A/C Components

## Cross Reference Chart - Short Code > OE

DCP05016	OE
BMW	65428377244

DCP05017	OE
BMW	64526904017
BMW	64526914369
BMW	64528363275

DCP05018	OE
BMW	64526904014
BMW	64526911340
BMW	64526914370
BMW	64528362414
BMW	64528385919

DCP05019	OE
BMW	64526914371
BMW	64528363485

DCP05020	OE
BMW	64509174802
BMW	64526917859
BMW	64526983098

DCP05021	OE
BMW	64509175481
BMW	64526901781
BMW	64526925721
BMW	64529175481

DCP05022	OE
BMW	64526922397
MINI	64536922397

DCP05026	OE
BMW	64526935613
BMW	64526987766

DCP05031	OE
BMW	64526918749

DCP05032	OE
BMW	64509174803
BMW	64526918753
BMW	64526956715
BMW	64529174803

DCP05033	OE
BMW	64526956719
BMW	64529188326
BMW	65526956719

DCP05034	OE
BMW	63526946871
BMW	64526946871

DCP05035	OE
BMW	64529118602

DCP05036	OE
BMW	64529122618

DCP05037	OE
BMW	64526924792
BMW	65526924792

DCP05038	OE
BMW	64526924788
BMW	65526924788

DCP05039	OE
BMW	64526915388

DCP05039	OE
BMW	64526916232
BMW	64526936883
BMW	64526956493

DCP05040	OE
BMW	64526915388

DCP05042	OE
BMW	64526950152

DCP05045	OE
BMW	64526956716

DCP05046	OE
BMW	64526909628
BMW	64526921651

DCP05050	OE
BMW	64526987862

DCP05052	OE
BMW	64509174805
BMW	64526915083
BMW	64526953474

DCP05060	OE
BMW	64526980085
BMW	64529174804
BMW	64529195721

DCP05061	OE
BMW	64526987863

DCP05062	OE
BMW	64526980044

DCP05076	OE
BMW	64509154072
BMW	64529154072
BMW	64529195978

DCP05077	OE
BMW	64526987890
BMW	64529196889

DCP05078	OE
BMW	64529154070
BMW	64529217868

DCP05079	OE
BMW	64509180550
BMW	64526933174
BMW	64529160816

DCP05080	OE
BMW	64509154071
BMW	64509192317
BMW	64529192317
BMW	64529195977

DCP05081	OE
BMW	64509196890
BMW	64529165808

DCP05082	OE
BMW	64506901781
BMW	64509180547
BMW	64529180547

DCP05083	OE
BMW	64526961621

DCP05084	OE
BMW	64509174806
BMW	64529122705
BMW	64529174806

DCP05088	OE
BMW	64529122619

DCP05089	OE
BMW	64529211496

DCP05090	OE
BMW	64529217869

DCP05091	OE
BMW	64529225704

DCP05092	OE
BMW	64509118602
BMW	64509180548

DCP05093	OE
BMW	64509180549

DCP05094	OE
BMW	64506901783
BMW	64526901783

DCP05095	OE
BMW	64529223694
BMW	64529225703

DCP05096	OE
BMW	64529216466

DCP05097	OE
BMW	64529216467

DCP05098	OE
BMW	64529222308

DCP05099	OE
BMW	64529223695

DCP05102	OE
BMW	64506947132
BMW	64509174807
BMW	64529174807

DCP05104	OE
BMW	64529222296

DCP05105	OE
BMW	64529330831

DCP05106	OE
BMW	64529330829

DCP05107	OE
BMW	64526901784
BMW	64526925720

DCP05108	OE
BMW	64526961618

DCP05114	OE
BMW	64529330827

DCP05115	OE
BMW	64529330825

DCP06001	OE
CHRYSLER	04677040E
CHRYSLER	4677040E

DCP06002	OE
CHRYSLER	04677299C
CHRYSLER	4677299C

DCP06003	OE
CHRYSLER	04677205AB
CHRYSLER	04677205L
CHRYSLER	4677205
CHRYSLER	4677205AB
CHRYSLER	4677205L

DCP06005	OE
CHRYSLER	04677144ABE

DCP06006	OE
CHRYSLER	046771144
CHRYSLER	04677144AB
CHRYSLER	046771156
CHRYSLER	04677156AB
CHRYSLER	4677144
CHRYSLER	4677144AB
CHRYSLER	4677156
CHRYSLER	4677156AB

DCP06009	OE
CHRYSLER	05278462AA
CHRYSLER	5264732
CHRYSLER	5278462AA
CHRYSLER	5278462AD

DCP06012	OE
CHRYSLER	05080494AA
CHRYSLER	05080494AB
CHRYSLER	05080494AC
CHRYSLER	05080494AA
CHRYSLER	5080494AB
CHRYSLER	5080494AC
MERCEDES-BENZ	0012303711
MERCEDES-BENZ	12303711
MERCEDES-BENZ	A0012303711

DCP06016	OE
CHRYSLER	05005420AD
CHRYSLER	05005420AF
CHRYSLER	5005420AA
CHRYSLER	5005420AC
CHRYSLER	5005420AD
CHRYSLER	5005420AE
CHRYSLER	5005420AF

DCP06017	OE
CHRYSLER	05005440AA
CHRYSLER	05005440AD
CHRYSLER	05005440AF
CHRYSLER	05005441AA
CHRYSLER	05005441AB
CHRYSLER	05005441AC
CHRYSLER	05005441AD
CHRYSLER	05005441AE
CHRYSLER	05005441AF
CHRYSLER	05005441AH
CHRYSLER	05005441AI
CHRYSLER	05005441AJ
CHRYSLER	5005440AA
CHRYSLER	5005440AD
CHRYSLER	5005440AF
CHRYSLER	5005441AA
CHRYSLER	5005441AB

DCP06017	OE
CHRYSLER	5005441AC
CHRYSLER	5005441AD
CHRYSLER	5005441AE
CHRYSLER	5005441AF
CHRYSLER	5005441AH
CHRYSLER	5005441AI
CHRYSLER	5005441AJ

DCP06018	OE
CHRYSLER	05005421AD
CHRYSLER	5005421AA
CHRYSLER	5005421AB
CHRYSLER	5005421AC
CHRYSLER	5005421AD
CHRYSLER	5005421AE

DCP06020	OE
CHRYSLER	55116835AC
CHRYSLER	55116835AD
CHRYSLER	55116835AE
CHRYSLER	55116835AF
CHRYSLER	55116835AE

DCP06021	OE
CHRYSLER	55116839AA
CHRYSLER	K55116839AA

DCP06022	OE
CHRYSLER	05058228AI
CHRYSLER	5058228AG
CHRYSLER	5058228AH
CHRYSLER	5058228AI
CHRYSLER	55111423AC
CHRYSLER	55111423AD
CHRYSLER	55111423AE
CHRYSLER	55111423AF
CHRYSLER	55111423AG
CHRYSLER	55111423AH
CHRYSLER	55111423AI

DCP06025	OE
CHRYSLER	55037467AA
CHRYSLER	55037467AB
CHRYSLER	55037467AD

DCP06026	OE
CHRYSLER	055056336AC
CHRYSLER	55056336AC

DCP06027	OE
CHRYSLER	55111035AA
CHRYSLER	55111035AB
CHRYSLER	55111035ABA

DCP06029	OE
CHRYSLER	55111425AA
CHRYSLER	55111425AB
CHRYSLER	55111425AC

DCP07010	OE
CITROEN/PEUGEOT	6453YQ
CITROEN/PEUGEOT	648742
CITROEN/PEUGEOT	96 840 758 80
CITROEN/PEUGEOT	96 890 848 80

DCP09001	OE
FIAT	46757907
FIAT	46786262
FIAT	60654446
FIAT	60814720
FIAT	60815788

DCP09001	OE
FIAT	71721737

DCP09002	OE
FIAT	46809223

DCP09003	OE
FIAT	46819144
FIAT	51746931
FIAT	5A79753
FIAT	71785265
FORD	1537745
FORD	9S5119D623BA
FORD	9S51-19D623-BA

DCP09004	OE
FIAT	46782669
FIAT	51747318
FIAT	71721733
FIAT	71781767
FIAT	71785268
FIAT	71785269
FORD	1535408
FORD	9S5119D623AA
FORD	9S51-19D623-AA

DCP09005	OE
FIAT	46757168
FIAT	46785772
FIAT	48785772
FIAT	71721735

DCP09006	OE
FIAT	46438576
FIAT	5440710
FIAT	54407100
FIAT	88410-87106

DCP09007	OE
FIAT	46514443
FIAT	46757377
FIAT	46785773

DCP09008	OE
FIAT	46811244
FIAT	51752531

DCP09009	OE
FIAT	46438366
FIAT	5440709
FIAT	54407090
FIAT	60812516

DCP09010	OE
FIAT	7765865

DCP09011	OE
FIAT	46427592
FIAT	46449285
FIAT	46479556
FIAT	46514137

DCP09012	OE
FIAT	5077705
FIAT	50777050
FIAT	7741901

DCP09013	OE
FIAT	46514636

DCP09014	OE
FIAT	46542341

DCP09014	OE
FIAT	46542431
FIAT	55897000
FIAT	88410-87106

DCP09015	OE
FIAT	5077706
FIAT	50777060
FIAT	7736928
FIAT	88410-87106

DCP09016	OE
FIAT	55194880
FIAT	5D337520
FIAT	71789105

DCP09017	OE
FIAT	55701201
FIAT	71746716
SUZUKI	095200-79JAO
SUZUKI	95200-79JAO

DCP09020	OE
FIAT	51794515
FIAT	71724083
FIAT	71793072
FIAT	71793959

DCP09032	OE
FIAT	51906240
FIAT	51935564
FIAT	51939001

DCP09034	OE
FIAT	51939001

DCP09060	OE
FIAT	52060460

DCP09061	OE
FIAT	52060461
FIAT	71781767
FIAT	71785269

DCP09062	OE
FIAT	50541342

DCP09063	OE
FIAT	50541343

DCP09064	OE
FIAT	50541346

DCP09K22	OE
FIAT GROUP	51803075
FIAT GROUP	55703917

DCP11001	OE
JAGUAR	CCC5992
JAGUAR	MNA7300AA
JAGUAR	MNA7300AB

DCP11002	OE
JAGUAR	MCA7300AD

DCP11003	OE
JAGUAR	MCA7300AE

DCP11007	OE
JAGUAR	3W83-19D629-AA
JAGUAR	3W83-19D629-AB

DCP11008	OE
ASTON MARTIN	4G43-19D629-AA
ASTON MARTIN	6G33-19D629-AA
ASTON MARTIN	6G33-19D629-AB

DCP11010	OE
JAGUAR	2W93-19D629-BC
JAGUAR	2W93-19D629-BF

DCP11011	OE
JAGUAR	2W93-19D629-CD
JAGUAR	C2C26770

DCP11012	OE
JAGUAR	6W93-19D629-AA
JAGUAR	6W93-19D629-AB

DCP11045	OE
JAGUAR	2W93-19D629-AE

DCP12001	OE
IVECO	500313156

DCP12003	OE
IVECO	504014391
IVECO	504277234
IVECO	504384698

DCP12004	OE
IVECO	500381465

DCP12005	OE
IVECO	500341617

DCP12008	OE
IVECO	504228992
IVECO	504385144
IVECO	98497470

DCP12009	OE
IVECO	504385146
IVECO	99488569

DCP12012	OE
IVECO	5801362246

DCP13001	OE
FIAT	7775422

DCP13005	OE
FIAT	51831803
FIAT	71789108

DCP13010	OE
FIAT	51820449

DCP14001	OE
LAND ROVER	BTR5750

DCP14002	OE
LAND ROVER	BTR4717

DCP14003	OE
LAND ROVER	BTR4719

DCP14004	OE
LAND ROVER	AWR1459

DCP14005	OE
LAND ROVER	AWR1458

# A/C Components

## Cross Reference Chart - Short Code > OE

DCP14006	OE
LAND ROVER	JPB101330
LAND ROVER	LR01205

DCP14007	OE
LAND ROVER	JPB000020

DCP14008	OE
LAND ROVER	JPB000030

DCP14012	OE
LAND ROVER	5H3219D623AB
LAND ROVER	8H22-19D623-BA
LAND ROVER	JPB500091
LAND ROVER	JPB500092
LAND ROVER	JPB500280
LAND ROVER	LR012796
LAND ROVER	LR015151
LAND ROVER	LR018427
LAND ROVER	LR019134

DCP14013	OE
LAND ROVER	8H22-19D623-AA
LAND ROVER	JPB000172
LAND ROVER	JPB000173
LAND ROVER	LR012593
LAND ROVER	LR012794

DCP14014	OE
LAND ROVER	8H2219D623CA
LAND ROVER	8H22-19D623-CA
LAND ROVER	JPB000183
LAND ROVER	LR014064

DCP14018	OE
LAND ROVER	JPB000040
LAND ROVER	JPB000040A
LAND ROVER	JPB101154
LAND ROVER	JPB101154L
LAND ROVER	JPB101430
LAND ROVER	JPB101430A
LAND ROVER	JPB101470
LAND ROVER	JPB500130

DCP14019	OE
LAND ROVER	7H3219D623AC
LAND ROVER	7H32-19D623-AC
LAND ROVER	JPB500201
LAND ROVER	LR014536
LAND ROVER	LR018426

DCP14020	OE
LAND ROVER	AH22-19D629-AA
LAND ROVER	LR013841

DCP15001	OE
CHEVROLET	89024881
GM	20931259

DCP17001	OE
MERCEDES-BENZ	0002302411
MERCEDES-BENZ	0031319501
MERCEDES-BENZ	2302411
MERCEDES-BENZ	31316601
MERCEDES-BENZ	31319501
MERCEDES-BENZ	A0002302411
MERCEDES-BENZ	A0031316601
MERCEDES-BENZ	A0031319501

DCP17002	OE
MERCEDES-BENZ	1101300115
MERCEDES-BENZ	2302611

DCP17002	OE
MERCEDES-BENZ	A0002302611
MERCEDES-BENZ	A1101300115

DCP17003	OE
MERCEDES-BENZ	0002302511
MERCEDES-BENZ	002341411
MERCEDES-BENZ	1161310001
MERCEDES-BENZ	2302511
MERCEDES-BENZ	2341411
MERCEDES-BENZ	A0002302511
MERCEDES-BENZ	A0002341411
MERCEDES-BENZ	A1161310001

DCP17005	OE
MERCEDES-BENZ	0002301711
MERCEDES-BENZ	2301711
MERCEDES-BENZ	A0002301711
MERCEDES-BENZ	A0002344603

DCP17006	OE
MERCEDES-BENZ	0002300311
MERCEDES-BENZ	1201300215
MERCEDES-BENZ	2300311
MERCEDES-BENZ	A0002300311
MERCEDES-BENZ	A0002345003
MERCEDES-BENZ	A1201300215

DCP17007	OE
MERCEDES-BENZ	0002300411
MERCEDES-BENZ	1191300115
MERCEDES-BENZ	2300411
MERCEDES-BENZ	A0002300411
MERCEDES-BENZ	A1191300115

DCP17008	OE
MERCEDES-BENZ	0002300011
MERCEDES-BENZ	2300011
MERCEDES-BENZ	A0002300011

DCP17010	OE
MERCEDES-BENZ	0002300511
MERCEDES-BENZ	1161300515
MERCEDES-BENZ	2300511
MERCEDES-BENZ	230051187
MERCEDES-BENZ	A0002300511
MERCEDES-BENZ	A000230051187
MERCEDES-BENZ	A0002344603
MERCEDES-BENZ	A1161300515

DCP17011	OE
MERCEDES-BENZ	0002300611
MERCEDES-BENZ	1191300015
MERCEDES-BENZ	2300611
MERCEDES-BENZ	A0002300611
MERCEDES-BENZ	A0002340028
MERCEDES-BENZ	A1191300015

DCP17012	OE
MERCEDES-BENZ	0002301111
MERCEDES-BENZ	1021300115
MERCEDES-BENZ	1021310001
MERCEDES-BENZ	2301111
MERCEDES-BENZ	41311301
MERCEDES-BENZ	A0002301111
MERCEDES-BENZ	A0041311301
MERCEDES-BENZ	A1021300115
MERCEDES-BENZ	A1021310001

DCP17013	OE
MERCEDES-BENZ	0002301211
MERCEDES-BENZ	0031316801

DCP17013	OE
MERCEDES-BENZ	2301211
MERCEDES-BENZ	31316801
MERCEDES-BENZ	6031300215
MERCEDES-BENZ	A0002301211
MERCEDES-BENZ	A0031316801
MERCEDES-BENZ	A6031300215

DCP17014	OE
MERCEDES-BENZ	0002301311
MERCEDES-BENZ	0002345203
MERCEDES-BENZ	2301311
MERCEDES-BENZ	230131111
MERCEDES-BENZ	A0002301311
MERCEDES-BENZ	A0023013111

DCP17015	OE
MERCEDES-BENZ	0002301611
MERCEDES-BENZ	2301611
MERCEDES-BENZ	A0002301611
MERCEDES-BENZ	A0002340028

DCP17017	OE
MERCEDES-BENZ	0002302211
MERCEDES-BENZ	0002302711
MERCEDES-BENZ	2302211
MERCEDES-BENZ	2302711
MERCEDES-BENZ	A0002302211
MERCEDES-BENZ	A0002302711
MERCEDES-BENZ	A0002346503

DCP17019	OE
MERCEDES-BENZ	0002303611
MERCEDES-BENZ	2303611
MERCEDES-BENZ	A0002303611

DCP17020	OE
MERCEDES-BENZ	0002303711
MERCEDES-BENZ	2303711
MERCEDES-BENZ	A0002303711

DCP17021	OE
MERCEDES-BENZ	0002304211
MERCEDES-BENZ	2304211
MERCEDES-BENZ	A0002304211

DCP17023	OE
MERCEDES-BENZ	0002302011
MERCEDES-BENZ	0002303911
MERCEDES-BENZ	0002307011
MERCEDES-BENZ	2302011
MERCEDES-BENZ	2303911
MERCEDES-BENZ	2307011
MERCEDES-BENZ	2340911
MERCEDES-BENZ	A0002302011
MERCEDES-BENZ	A0002303911
MERCEDES-BENZ	A0002307011
MERCEDES-BENZ	A0002340911
MERCEDES-BENZ	A0002346303

DCP17024	OE
MERCEDES-BENZ	0002306811
MERCEDES-BENZ	2306811
MERCEDES-BENZ	A0002306811

DCP17025	OE
MERCEDES-BENZ	0002305911
MERCEDES-BENZ	0002307911
MERCEDES-BENZ	000230791187
MERCEDES-BENZ	002302111
MERCEDES-BENZ	002305911
MERCEDES-BENZ	2302111

DCP17025	OE
MERCEDES-BENZ	2305911
MERCEDES-BENZ	2307911
MERCEDES-BENZ	230791187
MERCEDES-BENZ	A0002302111
MERCEDES-BENZ	A0002305911
MERCEDES-BENZ	A0002307911
MERCEDES-BENZ	A000230791187

DCP17026	OE
MERCEDES-BENZ	0002306511
MERCEDES-BENZ	0002308511
MERCEDES-BENZ	0002309011
MERCEDES-BENZ	0012300811
MERCEDES-BENZ	0012301111
MERCEDES-BENZ	0012301411
MERCEDES-BENZ	0012301911
MERCEDES-BENZ	0012306211
MERCEDES-BENZ	0022305011
MERCEDES-BENZ	0022306611
MERCEDES-BENZ	12300811
MERCEDES-BENZ	12301111
MERCEDES-BENZ	12301411
MERCEDES-BENZ	12301911
MERCEDES-BENZ	12306211
MERCEDES-BENZ	22301911
MERCEDES-BENZ	22305011
MERCEDES-BENZ	2305111
MERCEDES-BENZ	2306511
MERCEDES-BENZ	2308511
MERCEDES-BENZ	2309011
MERCEDES-BENZ	A0002305111
MERCEDES-BENZ	A0002306511
MERCEDES-BENZ	A0002308511
MERCEDES-BENZ	A0002309011
MERCEDES-BENZ	A0012300811
MERCEDES-BENZ	A0012301111
MERCEDES-BENZ	A0012301411
MERCEDES-BENZ	A0012301911
MERCEDES-BENZ	A0012306211
MERCEDES-BENZ	A0022305011

DCP17031	OE
MERCEDES-BENZ	9062300311
MERCEDES-BENZ	A9062300311

DCP17033	OE
MERCEDES-BENZ	0002301511
MERCEDES-BENZ	2301511
MERCEDES-BENZ	2340811
MERCEDES-BENZ	31318901
MERCEDES-BENZ	6161301015
MERCEDES-BENZ	A0002301511
MERCEDES-BENZ	A0002340811
MERCEDES-BENZ	A0031318901
MERCEDES-BENZ	A6161301015

DCP17034	OE
MERCEDES-BENZ	2340811
MERCEDES-BENZ	5412300011
MERCEDES-BENZ	5412300111
MERCEDES-BENZ	5412301011
MERCEDES-BENZ	A0002340811
MERCEDES-BENZ	A5412300011
MERCEDES-BENZ	A5412300111
MERCEDES-BENZ	A5412301011

DCP17035	OE
MERCEDES-BENZ	5412300411
MERCEDES-BENZ	5412301311
MERCEDES-BENZ	A5412300411
MERCEDES-BENZ	A5412301311

DCP17036	OE
MERCEDES-BENZ	5412300211
MERCEDES-BENZ	5412300611
MERCEDES-BENZ	5412301211
MERCEDES-BENZ	A5412300211
MERCEDES-BENZ	A5412300228
MERCEDES-BENZ	A5412300611
MERCEDES-BENZ	A5412301211

DCP17038	OE
MERCEDES-BENZ	0002306211
MERCEDES-BENZ	0002309711
MERCEDES-BENZ	0012302611
MERCEDES-BENZ	0012304511
MERCEDES-BENZ	0012305511
MERCEDES-BENZ	12302611
MERCEDES-BENZ	12304511
MERCEDES-BENZ	12305511
MERCEDES-BENZ	2306211
MERCEDES-BENZ	2309711
MERCEDES-BENZ	A0002306211
MERCEDES-BENZ	A0002309711
MERCEDES-BENZ	A0012302611
MERCEDES-BENZ	A0012304511
MERCEDES-BENZ	A0012305511

DCP17039	OE
MERCEDES-BENZ	0002341312
MERCEDES-BENZ	0012301011
MERCEDES-BENZ	0012301211
MERCEDES-BENZ	12301011
MERCEDES-BENZ	12301211
MERCEDES-BENZ	2341312
MERCEDES-BENZ	A0002341312
MERCEDES-BENZ	A0012301011
MERCEDES-BENZ	A0012301211

DCP17040	OE
MERCEDES-BENZ	A0012301411

DCP17041	OE
MERCEDES-BENZ	0012300111
MERCEDES-BENZ	12300111
MERCEDES-BENZ	A0012300111

DCP17043	OE
MERCEDES-BENZ	0002309111
MERCEDES-BENZ	0012300011
MERCEDES-BENZ	002309111
MERCEDES-BENZ	12300011
MERCEDES-BENZ	2309111
MERCEDES-BENZ	A0002309111
MERCEDES-BENZ	A0012300011

DCP17045	OE
MERCEDES-BENZ	0012305811
MERCEDES-BENZ	12305811
MERCEDES-BENZ	A0012305811

DCP17046	OE
MERCEDES-BENZ	0012300711
MERCEDES-BENZ	0012305411
MERCEDES-BENZ	12300711
MERCEDES-BENZ	A0012300711

DCP17050	OE
MERCEDES-BENZ	0002309411
MERCEDES-BENZ	2309411
MERCEDES-BENZ	A0002309411

DCP17051	OE
MERCEDES-BENZ	0002309311

DCP17051	OE
MERCEDES-BENZ	2309311
MERCEDES-BENZ	A0002309311

DCP17053	OE
MERCEDES-BENZ	0012305611
MERCEDES-BENZ	12305611
MERCEDES-BENZ	A0012305611

DCP17054	OE
mitsubishi	7813A058
mitsubishi	MR568990
SMART	4542300011
SMART	4542300111
SMART	A4542300011
SMART	A4542300111

DCP17055	OE
MERCEDES-BENZ	0012308711
MERCEDES-BENZ	0022305511
MERCEDES-BENZ	12307311
MERCEDES-BENZ	12308711
MERCEDES-BENZ	22305511
MERCEDES-BENZ	A0012307311
MERCEDES-BENZ	A0012308711
MERCEDES-BENZ	A0022305511

DCP17056	OE
mitsubishi	7813A059
SMART	1222300011
SMART	A1222300011

DCP17058	OE
MERCEDES-BENZ	0012302511
MERCEDES-BENZ	0012304811
MERCEDES-BENZ	0012308411
MERCEDES-BENZ	0022305411
MERCEDES-BENZ	12302511
MERCEDES-BENZ	12304811
MERCEDES-BENZ	12308411
MERCEDES-BENZ	22305411
MERCEDES-BENZ	A0012302511
MERCEDES-BENZ	A0012304811
MERCEDES-BENZ	A0012308411
MERCEDES-BENZ	A0022305411

DCP17059	OE
MERCEDES-BENZ	0012302011
MERCEDES-BENZ	0012305211
MERCEDES-BENZ	0012308211
MERCEDES-BENZ	12302011
MERCEDES-BENZ	12305211
MERCEDES-BENZ	12308211
MERCEDES-BENZ	A0012302011
MERCEDES-BENZ	A0012305211
MERCEDES-BENZ	A0012308211

DCP17060	OE
MERCEDES-BENZ	0022301211
MERCEDES-BENZ	0022306711
MERCEDES-BENZ	22301211
MERCEDES-BENZ	22306711
MERCEDES-BENZ	A0022301211
MERCEDES-BENZ	A0022306711

DCP17062	OE
MERCEDES-BENZ	0012304711
MERCEDES-BENZ	0012308311
MERCEDES-BENZ	0022305311
MERCEDES-BENZ	12304711
MERCEDES-BENZ	12308311
MERCEDES-BENZ	22305311

DCP17062	OE
MERCEDES-BENZ	A0012304711
MERCEDES-BENZ	A0012308311
MERCEDES-BENZ	A0022305311

DCP17063	OE
MERCEDES-BENZ	0002308811
MERCEDES-BENZ	0012308811
MERCEDES-BENZ	0022302111
MERCEDES-BENZ	0022305611
MERCEDES-BENZ	12307411
MERCEDES-BENZ	12308811
MERCEDES-BENZ	22302111
MERCEDES-BENZ	22305611
MERCEDES-BENZ	2308811
MERCEDES-BENZ	A0002308811
MERCEDES-BENZ	A0012307411
MERCEDES-BENZ	A0012308811
MERCEDES-BENZ	A0022302111
MERCEDES-BENZ	A0022305611

DCP17064	OE
MERCEDES-BENZ	0002308111
MERCEDES-BENZ	0012302811
MERCEDES-BENZ	002302811
MERCEDES-BENZ	002308111
MERCEDES-BENZ	12302811
MERCEDES-BENZ	2302811
MERCEDES-BENZ	2308111
MERCEDES-BENZ	A0002302811
MERCEDES-BENZ	A0002308111
MERCEDES-BENZ	A0012302811

DCP17065	OE
MERCEDES-BENZ	0022300511
MERCEDES-BENZ	22300511
MERCEDES-BENZ	A0022300511

DCP17067	OE
MERCEDES-BENZ	0012305711
MERCEDES-BENZ	0012307911
MERCEDES-BENZ	0012308611
MERCEDES-BENZ	12305711
MERCEDES-BENZ	12307911
MERCEDES-BENZ	12308611
MERCEDES-BENZ	A0012305711
MERCEDES-BENZ	A0012307911
MERCEDES-BENZ	A0012308611

DCP17068	OE
MERCEDES-BENZ	0012305411
MERCEDES-BENZ	0012308111
MERCEDES-BENZ	12305411
MERCEDES-BENZ	12308111
MERCEDES-BENZ	A0012305411
MERCEDES-BENZ	A0012308111

DCP17070	OE
MERCEDES-BENZ	0012303511
MERCEDES-BENZ	0012309011
MERCEDES-BENZ	0022301311
MERCEDES-BENZ	0022304711
MERCEDES-BENZ	12303511
MERCEDES-BENZ	12309011
MERCEDES-BENZ	22301311
MERCEDES-BENZ	22304711
MERCEDES-BENZ	A0012303511
MERCEDES-BENZ	A0012309011
MERCEDES-BENZ	A0022301311
MERCEDES-BENZ	A0022304711

DCP17071	OE
MERCEDES-BENZ	0012303611
MERCEDES-BENZ	0012309111
MERCEDES-BENZ	0022301411
MERCEDES-BENZ	0022304811
MERCEDES-BENZ	12303611
MERCEDES-BENZ	12309111
MERCEDES-BENZ	22301411
MERCEDES-BENZ	22304811
MERCEDES-BENZ	A0012303611
MERCEDES-BENZ	A0012309111
MERCEDES-BENZ	A0022301411
MERCEDES-BENZ	A0022304811

DCP17072	OE
MERCEDES-BENZ	0022301911
MERCEDES-BENZ	22301911
MERCEDES-BENZ	A0022301911

DCP17073	OE
MERCEDES-BENZ	2300111
MERCEDES-BENZ	HW0002300111
MERCEDES-BENZ	HW0002300311
VOLKSWAGEN	2E0820803B
VOLKSWAGEN	2E0820803C
VOLKSWAGEN	2E0820803D
VOLKSWAGEN	2E0820803G

DCP17080	OE
MERCEDES-BENZ	0002307611
MERCEDES-BENZ	2307611
MERCEDES-BENZ	A0002307611

DCP17084	OE
MERCEDES-BENZ	2340811
MERCEDES-BENZ	9062300111
MERCEDES-BENZ	A0002340811
MERCEDES-BENZ	A9062300111
MERCEDES-BENZ	VW9062300111
VOLKSWAGEN	2E0820803DH

DCP17085	OE
MERCEDES-BENZ	0012300211
MERCEDES-BENZ	12300211
MERCEDES-BENZ	A0012300211

DCP17086	OE
VOLKSWAGEN	A0012307911

DCP17087	OE
MERCEDES-BENZ	0012305011
MERCEDES-BENZ	12305011
MERCEDES-BENZ	A0012305011

DCP17090	OE
MERCEDES-BENZ	A0012301311

DCP17092	OE
MERCEDES-BENZ	2340811
MERCEDES-BENZ	5412300511
MERCEDES-BENZ	5412301111
MERCEDES-BENZ	A0002340811
MERCEDES-BENZ	A5412300511
MERCEDES-BENZ	A5412301111

DCP17095	OE
MERCEDES-BENZ	0002301811
MERCEDES-BENZ	2301811
MERCEDES-BENZ	A0002301811

DCP17100	OE
MERCEDES-BENZ	0022303111

# A/C Components

## Cross Reference Chart - Short Code > OE

DCP17100	OE
MERCEDES-BENZ	22303111
MERCEDES-BENZ	A002230311

DCP17101	OE
MERCEDES-BENZ	0022303011
MERCEDES-BENZ	0022304911
MERCEDES-BENZ	22303011
MERCEDES-BENZ	22304911
MERCEDES-BENZ	22308311
MERCEDES-BENZ	A0022303011
MERCEDES-BENZ	A0022304911
MERCEDES-BENZ	A0022308311

DCP17102	OE
MERCEDES-BENZ	0002309211
MERCEDES-BENZ	0012301311
MERCEDES-BENZ	0012303211
MERCEDES-BENZ	12301311
MERCEDES-BENZ	12303211
MERCEDES-BENZ	2309211
MERCEDES-BENZ	A0002309211
MERCEDES-BENZ	A0002341312
MERCEDES-BENZ	A0012301311
MERCEDES-BENZ	A0012303211

DCP17103	OE
MERCEDES-BENZ	0012308011
MERCEDES-BENZ	12308011
MERCEDES-BENZ	A0012308011

DCP17104	OE
MERCEDES-BENZ	0022303211
MERCEDES-BENZ	22303211
MERCEDES-BENZ	A0022303211

DCP17105	OE
MERCEDES-BENZ	0022305111
MERCEDES-BENZ	22305111
MERCEDES-BENZ	A0022305111

DCP17106	OE
MERCEDES-BENZ	0022306811
MERCEDES-BENZ	22306811
MERCEDES-BENZ	A0022306811

DCP17107	OE
MERCEDES-BENZ	0022306511
MERCEDES-BENZ	22306511
MERCEDES-BENZ	A0022306511

DCP17108	OE
MERCEDES-BENZ	A0012302611

DCP17109	OE
MERCEDES-BENZ	0032302311
MERCEDES-BENZ	32302311
MERCEDES-BENZ	A0032302311

DCP17112	OE
MERCEDES-BENZ	0022304411
MERCEDES-BENZ	0022304511
MERCEDES-BENZ	0022308411
MERCEDES-BENZ	0032304811
MERCEDES-BENZ	22304411
MERCEDES-BENZ	22304511
MERCEDES-BENZ	22308411
MERCEDES-BENZ	32304811
MERCEDES-BENZ	A0022304411
MERCEDES-BENZ	A0022304511
MERCEDES-BENZ	A0022308411
MERCEDES-BENZ	A0032304811

DCP17113	OE
MERCEDES-BENZ	4572300111
MERCEDES-BENZ	A457230011
MERCEDES-BENZ	A5412300228

DCP17114	OE
MERCEDES-BENZ	0002308011
MERCEDES-BENZ	2308011
MERCEDES-BENZ	A0002308011

DCP17115	OE
MERCEDES-BENZ	0012304911
MERCEDES-BENZ	0022303311
MERCEDES-BENZ	12304911
MERCEDES-BENZ	22303311
MERCEDES-BENZ	A0012304911
MERCEDES-BENZ	A0022303311

DCP17119	OE
MERCEDES-BENZ	A0012301911

DCP17120	OE
MERCEDES-BENZ	0022303811
MERCEDES-BENZ	22303811
MERCEDES-BENZ	A0022303811

DCP17121	OE
MERCEDES-BENZ	0012306911
MERCEDES-BENZ	12306911
MERCEDES-BENZ	A0012306911

DCP17122	OE
DODGE	68012250
MERCEDES-BENZ	0012307111
MERCEDES-BENZ	12307111
MERCEDES-BENZ	A0002303828
MERCEDES-BENZ	A0002344011
MERCEDES-BENZ	A0012307111

DCP17125	OE
CLAAS	4572300411
CLAAS	4572300711
CLAAS	A4572300411
CLAAS	A4572300711

DCP17126	OE
MERCEDES-BENZ	0022306211
MERCEDES-BENZ	22306211
MERCEDES-BENZ	A0022306211

DCP17127	OE
MERCEDES-BENZ	0022307511
MERCEDES-BENZ	22307511
MERCEDES-BENZ	A0022307511

DCP17128	OE
MERCEDES-BENZ	0012305111
MERCEDES-BENZ	12305111
MERCEDES-BENZ	A0012305111

DCP17129	OE
MERCEDES-BENZ	0022305711
MERCEDES-BENZ	22305711
MERCEDES-BENZ	A0022305711

DCP17130	OE
MERCEDES-BENZ	0022306611
MERCEDES-BENZ	22306611
MERCEDES-BENZ	A0022306611

DCP17131	OE
MERCEDES-BENZ	0022308111

DCP17131	OE
MERCEDES-BENZ	22308111
MERCEDES-BENZ	A0022308111

DCP17132	OE
MERCEDES-BENZ	0022307711
MERCEDES-BENZ	22307711
MERCEDES-BENZ	A0022307711

DCP17133	OE
MERCEDES-BENZ	0012304111
MERCEDES-BENZ	12304111
MERCEDES-BENZ	A0012304111

DCP17135	OE
MERCEDES-BENZ	0022302311
MERCEDES-BENZ	22302311
MERCEDES-BENZ	A0022302311

DCP17138	OE
MERCEDES-BENZ	0022305811
MERCEDES-BENZ	22305811
MERCEDES-BENZ	A0022305811

DCP17139	OE
MERCEDES-BENZ	0022308011
MERCEDES-BENZ	22308011
MERCEDES-BENZ	A0022308011

DCP17140	OE
MERCEDES-BENZ	0032308511
MERCEDES-BENZ	32302711
MERCEDES-BENZ	32308511
MERCEDES-BENZ	A0032302711
MERCEDES-BENZ	A0032308511

DCP17142	OE
MERCEDES-BENZ	0022300711
MERCEDES-BENZ	22300711
MERCEDES-BENZ	A0022300711

DCP17143	OE
MERCEDES-BENZ	0022308211
MERCEDES-BENZ	22308211
MERCEDES-BENZ	A0022301111
MERCEDES-BENZ	A0022308211

DCP17144	OE
MERCEDES-BENZ	0002308611
MERCEDES-BENZ	002307211
MERCEDES-BENZ	002308611
MERCEDES-BENZ	2307211
MERCEDES-BENZ	2308611
MERCEDES-BENZ	A0002307211
MERCEDES-BENZ	A0002308611

DCP17146	OE
MERCEDES-BENZ	0012304411
MERCEDES-BENZ	12304411
MERCEDES-BENZ	12308311
MERCEDES-BENZ	A0012304411

DCP17147	OE
MERCEDES-BENZ	1192300011
MERCEDES-BENZ	1192300111
MERCEDES-BENZ	A1192300011
MERCEDES-BENZ	A1192300111

DCP17148	OE
MERCEDES-BENZ	0032302911
MERCEDES-BENZ	32302911
MERCEDES-BENZ	A0032302911

DCP17150	OE
MERCEDES-BENZ	0012307011
MERCEDES-BENZ	12307011
MERCEDES-BENZ	A0012307011

DCP17151	OE
MERCEDES-BENZ	0032309011
MERCEDES-BENZ	32309011
MERCEDES-BENZ	A0032309011

DCP17152	OE
MERCEDES-BENZ	0022301811
MERCEDES-BENZ	22301811
MERCEDES-BENZ	A0022301811

DCP17153	OE
MERCEDES-BENZ	0002307811
MERCEDES-BENZ	2307811
MERCEDES-BENZ	A0002307811

DCP17154	OE
MERCEDES-BENZ	0032308711
MERCEDES-BENZ	32308711
MERCEDES-BENZ	A0032308711

DCP17155	OE
MERCEDES-BENZ	0008302600
MERCEDES-BENZ	8302600
MERCEDES-BENZ	A0008302600

DCP17156	OE
MERCEDES-BENZ	0008303100
MERCEDES-BENZ	8303100
MERCEDES-BENZ	A0008303100

DCP17157	OE
MERCEDES-BENZ	0022309211
MERCEDES-BENZ	22309211
MERCEDES-BENZ	A0022309211

DCP17158	OE
MERCEDES-BENZ	0022302911
MERCEDES-BENZ	22302911
MERCEDES-BENZ	A0022302911

DCP17159	OE
MERCEDES-BENZ	A0022307311

DCP17160	OE
MERCEDES-BENZ	A0012301611

DCP17161	OE
MERCEDES-BENZ	A0022309711

DCP17162	OE
MERCEDES-BENZ	32307911
MERCEDES-BENZ	A0032307911

DCP17163	OE
MERCEDES-BENZ	32308011
MERCEDES-BENZ	A0032308011

DCP17164	OE
MERCEDES-BENZ	22306311
MERCEDES-BENZ	A0022306311

DCP17165	OE
MERCEDES-BENZ	A0008302500

DCP17166	OE
MERCEDES-BENZ	8302100
MERCEDES-BENZ	A0008302100

DCP17167	OE
MERCEDES-BENZ	A0042300311

DCP17168	OE
MERCEDES-BENZ	38304160
MERCEDES-BENZ	A0038304160

DCP17169	OE
MERCEDES-BENZ	8302200
MERCEDES-BENZ	A0008302200

DCP17171	OE
MERCEDES-BENZ	A4478307300

DCP17176	OE
MERCEDES-BENZ	A0032302811

DCP17177	OE
MERCEDES-BENZ	A0008302300

DCP17178	OE
MERCEDES-BENZ	A0032308811

DCP17179	OE
MERCEDES-BENZ	A0008302700

DCP17180	OE
MERCEDES-BENZ	A0012300911

DCP17181	OE
MERCEDES-BENZ	A0032306011

DCP17182	OE
MERCEDES-BENZ	A0008303600

DCP17185	OE
MERCEDES-BENZ	A9362300111

DCP17186	OE
MERCEDES-BENZ	A4722300111

DCP17501	OE
CLAAS	796999.1
CLAAS	7969991
CLAAS	9062302011
CLAAS	A9062302011

DCP17505	OE
CLAAS	4572300211
CLAAS	A4572300211

DCP17508	OE
MERCEDES-BENZ	5412300711
MERCEDES-BENZ	A5412300711

DCP17B29	OE
MERCEDES-BENZ	2343711
MERCEDES-BENZ	A0002343711

DCP17B35	OE
MERCEDES-BENZ	0002343111
MERCEDES-BENZ	2343111
MERCEDES-BENZ	A0002343111

DCP17C33	OE
MERCEDES-BENZ	0002340128
MERCEDES-BENZ	2340128
MERCEDES-BENZ	A0002340128

DCP17C36	OE
MERCEDES-BENZ	5412300028
MERCEDES-BENZ	5412300928

DCP17C36	OE
MERCEDES-BENZ	A5412300028
MERCEDES-BENZ	A5412300928

DCP17K37	OE
MERCEDES-BENZ	5412301411
MERCEDES-BENZ	5412301511
MERCEDES-BENZ	A5412301411
MERCEDES-BENZ	A5412301511

DCP20001	OE
GM	90 457 635
GM	90457635

DCP20003	OE
GM	90507617
OPEL	1854066
OPEL	1854148

DCP20004	OE
GM	24416177
GM	24428118
GM	24430230
GM	9122119
OPEL	1854096
OPEL	1854120
OPEL	6854000

DCP20005	OE
GM	24416178
GM	24430319
GM	9212120
GM	93176862
GM	R1580029
OPEL	1854097
OPEL	1854121
OPEL	6854001
OPEL	6854031

DCP20006	OE
GM	90564976
OPEL	1854084
OPEL	9241681

DCP20021	OE
GM	55701200
GM	5E527520
GM	93190812
OPEL	6854091
OPEL	6854102

DCP20021K	OE
GM	55352021
GM	55565236
GM	55701200
GM	5E527520
GM	93190812
OPEL	1340267
OPEL	6340553
OPEL	6854091
OPEL	6854102

DCP20022	OE
FIAT	55702161
FIAT	55703917
FIAT	5D33751
FIAT	5D337510
GM	55703721
GM	5E527540
GM	93190815
OPEL	5E52754
OPEL	6854093

DCP20022	OE
OPEL	6854104

DCP20023	OE
FIAT	55702661
GM	93190814
OPEL	6854103

DCP20030	OE
GM	24443138

DCP20120	OE
OPEL-VAUXHALL	13447214
OPEL-VAUXHALL	39006351
OPEL-VAUXHALL	39079897
OPEL-VAUXHALL	95518238

DCP20121	OE
OPEL-VAUXHALL	13427705
OPEL-VAUXHALL	39006350
OPEL-VAUXHALL	39079896
OPEL-VAUXHALL	95518239

DCP20122	OE
OPEL-VAUXHALL	13447213
OPEL-VAUXHALL	39006352
OPEL-VAUXHALL	39079898
OPEL-VAUXHALL	9518237

DCP20123	OE
OPEL-VAUXHALL	39006353
OPEL-VAUXHALL	39079899

DCP21014	OE
CITROEN/PEUGEOT	6453WH
CITROEN/PEUGEOT	6487.41
CITROEN/PEUGEOT	648740
CITROEN/PEUGEOT	648741
CITROEN/PEUGEOT	96 598 755 80
CITROEN/PEUGEOT	96 890 847 80
CITROEN/PEUGEOT	9659875580
CITROEN/PEUGEOT	9689084780

DCP21015	OE
CITROEN/PEUGEOT	1608325980
CITROEN/PEUGEOT	96 722 470 80
CITROEN/PEUGEOT	9672247080

DCP21016	OE
CITROEN/PEUGEOT	96 756 558 80
CITROEN/PEUGEOT	9675655880
CITROEN/PEUGEOT	9675659880
CITROEN/PEUGEOT	9807722580
CITROEN/PEUGEOT	9809274280
CITROEN/PEUGEOT	9810347280

DCP21017	OE
CITROEN/PEUGEOT	96 756 578 80
CITROEN/PEUGEOT	96 756 599 80
CITROEN/PEUGEOT	9675657880
CITROEN/PEUGEOT	9675659980

DCP21021	OE
CITROEN/PEUGEOT	1606467480
CITROEN/PEUGEOT	6453WF
CITROEN/PEUGEOT	6487.39
CITROEN/PEUGEOT	648738
CITROEN/PEUGEOT	648739
CITROEN/PEUGEOT	96 768 623 80
CITROEN/PEUGEOT	96 598 754 80
CITROEN/PEUGEOT	96 890 798 80
CITROEN/PEUGEOT	9659875480

DCP21021	OE
CITROEN/PEUGEOT	9676443980
CITROEN/PEUGEOT	9676862380
CITROEN/PEUGEOT	9689079880
CITROEN/PEUGEOT	9822101380
CITROEN/PEUGEOT	9822101780

DCP21022	OE
CITROEN/PEUGEOT	9801764380
CITROEN/PEUGEOT	9802875780
CITROEN/PEUGEOT	9819714880
CITROEN/PEUGEOT	9819714980

DCP21023	OE
PEUGEOT-CITROEN AUTOMOBILE	9810347280

DCP21024	OE
PEUGEOT-CITROEN AUTOMOBILE	9815198580

DCP21025	OE
PEUGEOT-CITROEN AUTOMOBILE	9822184980

DCP23002	OE
RENAULT	5010284917

DCP23025	OE
ISUZU	8973557690
ISUZU	8-97355769-0
RENAULT	7701474008
RENAULT	926003370R

DCP23030	OE
RENAULT	7711497392
RENAULT	8200939386

DCP23031	OE
RENAULT	7711497391
RENAULT	8200956574

DCP23032	OE
RENAULT	7711497568
RENAULT	8200958328

DCP23034	OE
RENAULT	926005211R
RENAULT	926009944R

DCP23035	OE
RENAULT	926008209R

DCP23530	OE
RENAULT	1028683.1
RENAULT	10286831
RENAULT	7700038545

DCP23531	OE
CLAAS	1032752.1
RENAULT	10327521
RENAULT	7700042614

DCP23535	OE
RENAULT	1043536.1
RENAULT	10435361
RENAULT	7700053414
RENAULT	7700053474

DCP23537	OE
RENAULT	1101155.1
RENAULT	11011550
RENAULT	11011551



# A/C Components

## Cross Reference Chart - Short Code > OE

DCP23538	OE
RENAULT	7700038094

DCP23539	OE
CLAAS	21894190

DCP23540	OE
CLAAS	21894090

DCP23541	OE
CLAAS	21894130

DCP24001	OE
LAND ROVER	JPB010032
LAND ROVER	JPB10032

DCP24004	OE
LAND ROVER	JPB101144
LAND ROVER	JPB101450
LAND ROVER	JPB101450A
LAND ROVER	JPB500110

DCP24005	OE
LAND ROVER	JPB101161
LAND ROVER	JPB101460
LAND ROVER	JPB101460A
LAND ROVER	JPB101461
LAND ROVER	JPB500120

DCP25001	OE
GM	4541207
GM	4869483
GM	5048095
SAAB	50 48 095
SAAB	5046891

DCP27001	OE
SEAT	6Q0820803D
SEAT	6Q0820803DX
SEAT	6Q0820803H
SEAT	6Q0820803HX
VOLKSWAGEN	6Q0820803D
VOLKSWAGEN	6Q0820803DX
VOLKSWAGEN	6Q0820803H
VOLKSWAGEN	6Q0820803HX

DCP27002	OE
AUDI	6Q0820803G
AUDI	6Q0820803GX
SEAT	6Q0820803G
SEAT	6Q0820803GX
SKODA	6Q0820803G
SKODA	6Q0820803GX
VOLKSWAGEN	6Q0820803G
VOLKSWAGEN	6Q0820803GX

DCP28001	OE
PORSCHE	944 126 008 00

DCP28003	OE
PORSCHE	964 126 121 01

DCP28004	OE
PORSCHE	964 126 121 02

DCP28006	OE
PORSCHE	928 126 113 01

DCP28008	OE
PORSCHE	996 126 011 51
PORSCHE	996 126 011 52
PORSCHE	996 573 926 00

DCP28010	OE
PORSCHE	948 126 011 00
PORSCHE	948 126 011 01
VOLKSWAGEN	7L5820803
VOLKSWAGEN	7L5820803A

DCP28012	OE
PORSCHE	9A1 126 011 02
PORSCHE	9A1 126 011 05

DCP28014	OE
PORSCHE	948 126 011 02
PORSCHE	948 126 011 03

DCP28016	OE
PORSCHE	997 126 011 90

DCP28017	OE
PORSCHE	970 126 011 02
PORSCHE	970 126 011 05

DCP28018	OE
PORSCHE	95B260805B

DCP28019	OE
PORSCHE	7P5816803A
PORSCHE	7P5820803B
PORSCHE	7P5820803D

DCP32001	OE
AUDI	8D0260805C
AUDI	8D0260805K
VOLKSWAGEN	8D0260805C
VOLKSWAGEN	8D0260805K
VOLKSWAGEN	8D0260805KX

DCP32002	OE
VOLKSWAGEN	1K0820803F

DCP32003	OE
AUDI	1K0820803A
AUDI	1K0820803F
AUDI	1K0820803J
SEAT	1K0820803A
SEAT	1K0820803F
SKODA	1K0820803A
SKODA	1K0820803F
SKODA	1K0820803J
VOLKSWAGEN	1K0820803A
VOLKSWAGEN	1K0820803F
VOLKSWAGEN	1K0820803J

DCP32005	OE
SEAT	6Q0820803K
SEAT	6Q0820803Q
SEAT	6Q0820803R
SEAT	6Q0820808A
SEAT	6Q0820808C
SEAT	6Q0820808E
SEAT	6Q0820808G
SEAT	6Q0820808GX
SKODA	6Q0820803K
SKODA	6Q0820803Q
SKODA	6Q0820803R
SKODA	6Q0820808A
SKODA	6Q0820808C
SKODA	6Q0820808E
SKODA	6Q0820808G
SKODA	6Q0820808GX
VOLKSWAGEN	6Q0820803K
VOLKSWAGEN	6Q0820803Q
VOLKSWAGEN	6Q0820803R

DCP32005	OE
VOLKSWAGEN	6Q0820808A
VOLKSWAGEN	6Q0820808C
VOLKSWAGEN	6Q0820808E
VOLKSWAGEN	6Q0820808G
VOLKSWAGEN	6Q0820808GX

DCP32006	OE
VOLKSWAGEN	3D0820805B
VOLKSWAGEN	3D0820805Q
VOLKSWAGEN	7H0820805
VOLKSWAGEN	7H0820805A
VOLKSWAGEN	7H0820805B
VOLKSWAGEN	7H0820805C
VOLKSWAGEN	7H0820805E
VOLKSWAGEN	7H0820805F
VOLKSWAGEN	7H0820805G
VOLKSWAGEN	7H0820805H
VOLKSWAGEN	7H0820805J

DCP32006K	OE
VOLKSWAGEN	070903201E
VOLKSWAGEN	070903327D
VOLKSWAGEN	3D0820805B
VOLKSWAGEN	7H0820805
VOLKSWAGEN	7H0820805A
VOLKSWAGEN	7H0820805B
VOLKSWAGEN	7H0820805C
VOLKSWAGEN	7H0820805E
VOLKSWAGEN	7H0820805F
VOLKSWAGEN	7H0820805G
VOLKSWAGEN	7H0820805H
VOLKSWAGEN	7H0820805J

DCP32020	OE
SEAT	6Q0820803J
SEAT	6Q0820803P
SEAT	6Q0820808
SEAT	6Q0820808B
SEAT	6Q0820808D
SEAT	6Q0820808F
SEAT	6Q0820808FX
SKODA	6Q0820803J
SKODA	6Q0820803P
SKODA	6Q0820808
SKODA	6Q0820808B
SKODA	6Q0820808D
SKODA	6Q0820808F
SKODA	6Q0820808FX
VOLKSWAGEN	6Q0820803J
VOLKSWAGEN	6Q0820803P
VOLKSWAGEN	6Q0820808
VOLKSWAGEN	6Q0820808B
VOLKSWAGEN	6Q0820808D
VOLKSWAGEN	6Q0820808F
VOLKSWAGEN	6Q0820808FX

DCP32021	OE
VOLKSWAGEN	3D0820803A
VOLKSWAGEN	3D0820803B
VOLKSWAGEN	3D0820803G
VOLKSWAGEN	3D0820803H
VOLKSWAGEN	3D0820803J
VOLKSWAGEN	3D0820803M
VOLKSWAGEN	3D0820803P
VOLKSWAGEN	3D0820803T
VOLKSWAGEN	3D0820805C

DCP32022	OE
AUDI	7L6820803C
AUDI	7L6820803F
AUDI	7L6820803J

DCP32022	OE
AUDI	7L6820803K
AUDI	7L6820803M
AUDI	7L6820803Q
AUDI	7L6820803T
AUDI	7P0820803D
AUDI	7P0820803N
PORSCHE	955 126 011 12
VOLKSWAGEN	7L6820803C
VOLKSWAGEN	7L6820803F
VOLKSWAGEN	7L6820803J
VOLKSWAGEN	7L6820803K
VOLKSWAGEN	7L6820803M
VOLKSWAGEN	7L6820803Q
VOLKSWAGEN	7L6820803T
VOLKSWAGEN	7P0820803D
VOLKSWAGEN	7P0820803N

DCP32023	OE
VOLKSWAGEN	7L6820803A
VOLKSWAGEN	7L6820803B

DCP32031	OE
AUDI	7P0820803E
VOLKSWAGEN	7L6820803D
VOLKSWAGEN	7L6820803G
VOLKSWAGEN	7L6820803L
VOLKSWAGEN	7L6820803P
VOLKSWAGEN	7L6820803S
VOLKSWAGEN	7P0820803E
VOLKSWAGEN	7P0820803M

DCP32045	OE
AUDI	1K0820803E
AUDI	1K0820803G
AUDI	1K0820803P
AUDI	1K0820803Q
AUDI	1K0820803S
AUDI	1K0820808B
AUDI	1K0820808BX
AUDI	1K0820808D
AUDI	1K0820808DX
AUDI	1K0820808F
AUDI	1K0820859C
AUDI	1K0820859E
AUDI	1K0820859F
AUDI	1K0820859M
AUDI	1K0820859QX
AUDI	1K0820859S
AUDI	1K0820859SX
SEAT	1K0820803E
SEAT	1K0820803G
SEAT	1K0820803P
SEAT	1K0820803Q
SEAT	1K0820803S
SEAT	1K0820808D
SEAT	1K0820808DX
SEAT	1K0820808F
SEAT	1K0820859C
SEAT	1K0820859E
SEAT	1K0820859F
SEAT	1K0820859M
SEAT	1K0820859QX
SEAT	1K0820859S
SEAT	1K0820859SX
SKODA	1K0820803E
SKODA	1K0820803G
SKODA	1K0820803P
SKODA	1K0820803Q
SKODA	1K0820803S
SKODA	1K0820808D
SKODA	1K0820808DX

DCP32045	OE
SKODA	1K0820808F
SKODA	1K0820859C
SKODA	1K0820859E
SKODA	1K0820859F
SKODA	1K0820859M
SKODA	1K0820859QX
SKODA	1K0820859S
SKODA	1K0820859SX
VOLKSWAGEN	1K0820803E
VOLKSWAGEN	1K0820803G
VOLKSWAGEN	1K0820803N
VOLKSWAGEN	1K0820803P
VOLKSWAGEN	1K0820803Q
VOLKSWAGEN	1K0820803S
VOLKSWAGEN	1K0820808D
VOLKSWAGEN	1K0820808DX
VOLKSWAGEN	1K0820808F
VOLKSWAGEN	1K0820808FX
VOLKSWAGEN	1K0820812B
VOLKSWAGEN	1K0820859C
VOLKSWAGEN	1K0820859E
VOLKSWAGEN	1K0820859F
VOLKSWAGEN	1K0820859M
VOLKSWAGEN	1K0820859Q
VOLKSWAGEN	1K0820859QX
VOLKSWAGEN	1K0820859S
VOLKSWAGEN	1K0820859SX

DCP32050	OE
VOLKSWAGEN	7E0820803

DCP32051	OE
VOLKSWAGEN	7L6820803E
VOLKSWAGEN	7L6820803H
VOLKSWAGEN	7L6820803R

DCP32052	OE
PORSCHE	955 126 011 00
VOLKSWAGEN	3B0820803C
VOLKSWAGEN	3B0820803CX

DCP32055	OE
VOLKSWAGEN	7P0820803E

DCP32056	OE
VOLKSWAGEN	5N0820803F

DCP32060	OE
AUDI	5K0820803
AUDI	5K0820803C
AUDI	5K0820803X
AUDI	5N0820803B
AUDI	5N0820803C
AUDI	5N0820803G
AUDI	5N0820803HX
AUDI	5Q0820803
AUDI	5Q0820803A
AUDI	5Q0820803B
AUDI	5Q0820803C
AUDI	5Q0820803D
AUDI	5Q0820803E
AUDI	5Q0820803F
SEAT	5K0820803
SEAT	5K0820803C
SEAT	5K0820803X
SEAT	5N0820803C
SEAT	5N0820803G
SEAT	5N0820803HX
SEAT	5Q0820803
SEAT	5Q0820803A
SEAT	5Q0820803B

DCP32060	OE
SEAT	5Q0820803C
SEAT	5Q0820803D
SEAT	5Q0820803E
SEAT	5Q0820803F
SKODA	5K0820803
SKODA	5K0820803C
SKODA	5K0820803X
SKODA	5N0820803C
SKODA	5N0820803G
SKODA	5N0820803HX
SKODA	5Q0820803
SKODA	5Q0820803A
SKODA	5Q0820803C
SKODA	5Q0820803D
SKODA	5Q0820803E
SKODA	5Q0820803F
VAG	5K0820803CX
VAG	5Q0820803J
VAG	5Q0820803K
VOLKSWAGEN	5K0820803
VOLKSWAGEN	5K0820803C
VOLKSWAGEN	5K0820803CX
VOLKSWAGEN	5K0820803X
VOLKSWAGEN	5N0820803
VOLKSWAGEN	5N0820803A
VOLKSWAGEN	5N0820803H
VOLKSWAGEN	5Q0820803
VOLKSWAGEN	5Q0820803A
VOLKSWAGEN	5Q0820803B
VOLKSWAGEN	5Q0820803C
VOLKSWAGEN	5Q0820803D
VOLKSWAGEN	5Q0820803E
VOLKSWAGEN	5Q0820803F

DCP32061	OE
VOLKSWAGEN	4G0260805D
VOLKSWAGEN	8K0260805M

DCP32062	OE
AUDI	4H0260805G

DCP32063	OE
VOLKSWAGEN	4L0820803

DCP32064	OE
VOLKSWAGEN	7P0820803F
VOLKSWAGEN	7P0820803L

DCP32065	OE
VOLKSWAGEN	7E0820803J

DCP32066	OE
VOLKSWAGEN	7E0820803E
VOLKSWAGEN	7E0820803G

DCP32067	OE
VOLKSWAGEN	2E0820805

DCP32068	OE
MERCEDES-BENZ	9068300260
MERCEDES-BENZ	HVV906830026
MERCEDES-BENZ	HVV9068300260
VOLKSWAGEN	2E0820803H
VOLKSWAGEN	2E0820803J

DCP32069	OE
VOLKSWAGEN	7E0820803A

DCP32070	OE
VOLKSWAGEN	7E0820803D
VOLKSWAGEN	7E0820803F

DCP32071	OE
VOLKSWAGEN	4H0260805F
VOLKSWAGEN	7P6820803B

DCP32072	OE
VOLKSWAGEN	7E0820803H

DCP32073	OE
VOLKSWAGEN	7E0820803N

DCP32074	OE
VAG	2H0820803A

DCP32075	OE
VAG	7E0816803C

DCP32076	OE
VAG	7E0816803D

DCP32077	OE
VAG	7E0820803P

DCP32080	OE
VAG	5Q0816803
VAG	5Q0816803B
VAG	5Q0816803D
VAG	5Q0816803E
VAG	5Q0816803F

DCP36001	OE
SUBARU	73111AG030
SUBARU	73111-AG030
TOYOTA	88410-B1010

DCP36002	OE
SUBARU	73111AG000
SUBARU	73111-AG000
SUBARU	73111AG001
SUBARU	73111-AG001

DCP36003	OE
SUBARU	73111AG010
SUBARU	73111-AG010
SUBARU	73111AG011
SUBARU	73111-AG011
SUBARU	73111AG012
SUBARU	73111-AG012
TOYOTA	88410-1A320

DCP36004	OE
SUBARU	73111AG020
SUBARU	73111-AG020
SUBARU	73111AJ020
SUBARU	73111-AJ020

DCP36005	OE
SUBARU	73111AE030
SUBARU	73111-AE030

DCP36006	OE
SUBARU	73111AE080
SUBARU	73111-AE080

DCP36007	OE
SUBARU	73111XA010
SUBARU	73111-XA010

DCP40002	OE
HONDA	38800PDAE01
HONDA	38800-PDA-E01
HONDA	38810PDAE01
HONDA	38810-PDA-E01

DCP40003	OE
HONDA	38800-RMA-G021
HONDA	38810-RMA-G01
HONDA	38810-RMA-G02

DCP40004	OE
HONDA	38800R06G01
HONDA	38800-R06-G01
HONDA	38810R06G01
HONDA	38810-R06-G01

DCP40012	OE
HONDA	38800RAAA01
HONDA	38800-RAA-A01

DCP40015	OE
HONDA	38800RJJ0031
HONDA	38800-RJJ-0031

DCP40017	OE
HONDA	38810R7CG02

DCP40018	OE
HONDA	38810RFWG01

DCP44010	OE
MAZDA	F15161450A
MAZDA	F15161K00A

DCP45003	OE
MITSUBISHI	7813A132

DCP45004	OE
MITSUBISHI	7813A084
MITSUBISHI	7813A185
MITSUBISHI	S8833-01270

DCP45005	OE
MITSUBISHI	7813A085
MITSUBISHI	7813A186
MITSUBISHI	S8833-01270

DCP45006	OE
MITSUBISHI	7813A162
MITSUBISHI	7813A183
MITSUBISHI	7813A190

DCP45008	OE
MITSUBISHI	MR360816

DCP45009	OE
MITSUBISHI	MR360816
MITSUBISHI	MR500876
MITSUBISHI	MR500958
MITSUBISHI	MR568289

DCP45010	OE
MITSUBISHI	MB918534
MITSUBISHI	MR149370

DCP45011	OE
MITSUBISHI	MR500877
MITSUBISHI	MR513348
MITSUBISHI	MR568290

# A/C Components | Cross Reference Chart - Short Code > OE

DCP45012	OE
mitsubishi	MR398533

DCP45013	OE
mitsubishi	7813A163
mitsubishi	7813A184
mitsubishi	7813A190

DCP45014	OE
mitsubishi	MR398535

DCP46020	OE
NISSAN	92600 4EBOA
NISSAN	92600 4BE0A

DCP46021	OE
NISSAN	92600 4EFOA

DCP46022	OE
NISSAN	92600 4EA0A
RENAULT	926000994R

DCP46024	OE
NISSAN	926004PBOA
RENAULT	926004PBOA

DCP46025	OE
NISSAN	92600 4CA2A

DCP47001	OE
SUZUKI	095200-67D01
SUZUKI	88320-25140
SUZUKI	95200-67D01

DCP47002	OE
SUZUKI	095200-76G21
SUZUKI	95200-76G21
SUZUKI	95210-76G13

DCP47003	OE
SUZUKI	095200-65DA0
SUZUKI	095200-65DA1
SUZUKI	095200-65DC1
SUZUKI	095200-65DF1
SUZUKI	095200-67D30
SUZUKI	95210-65DA0
SUZUKI	S8832-01820

DCP47004	OE
SUZUKI	095200-65DJ0
SUZUKI	95200-65DJ0
SUZUKI	95210-65DA0

DCP47006	OE
SUZUKI	095200-M67D40
SUZUKI	095200M-67D40
SUZUKI	88320-25140
SUZUKI	95201-M79F00
SUZUKI	95210-67D40

DCP47007	OE
SUZUKI	95200-70CJ0

DCP47008	OE
SUZUKI	95200-72F00

DCP47009	OE
SUZUKI	95200-62M11
SUZUKI	95200-62M11000
SUZUKI	95200-62M12
SUZUKI	95200-62M12000

DCP47010	OE
SUZUKI	95200-55P10
SUZUKI	95200-55P10000

DCP47011	OE
SUZUKI	95200-61M10
SUZUKI	95200-61M10000

DCP47012	OE
SUZUKI	95200-54PA0
SUZUKI	95200-54PA0000

DCP47013	OE
SUZUKI	95200-54PB0
SUZUKI	95200-54PB0000

DCP49001	OE
DAIHATSU	88310B1070
DAIHATSU	88310-B1070
DAIHATSU	88310B1070000
DAIHATSU	88310-B1070-000
DAIHATSU	88310BZ160
DAIHATSU	88310-BZ160
DAIHATSU	8832087401000
DAIHATSU	88320-87401-000
DAIHATSU	88320-97401
DAIHATSU	8832097401000
DAIHATSU	88320-97401-000
DAIHATSU	88410-B1030

DCP49002	OE
DAIHATSU	8831097405
DAIHATSU	8831097405000
DAIHATSU	88310-97405-000
DAIHATSU	88410-97212
TOYOTA	88310-97405
TOYOTA	88320-97209
TOYOTA	88410-97212

DCP50001	OE
TOYOTA	88310-0D010
TOYOTA	88310-0D140
TOYOTA	88310-0D141

DCP50002	OE
TOYOTA	88310-0D120
TOYOTA	88310-52340
TOYOTA	88310-52341
TOYOTA	88320-52130
TOYOTA	88320-52430
TOYOTA	88410-52150
TOYOTA	88410-52260

DCP50003	OE
TOYOTA	88310-52371
TOYOTA	88320-52430

DCP50004	OE
TOYOTA	88310-0D090
TOYOTA	88310-0D091
TOYOTA	88310-0D180
TOYOTA	88310-52400
TOYOTA	88310-52401
TOYOTA	88320-52080
TOYOTA	88320-52370
TOYOTA	88410-52250

DCP50005	OE
TOYOTA	88310-52141
TOYOTA	88310-52421
TOYOTA	88320-52080
TOYOTA	88410-52290

DCP50006	OE
TOYOTA	88310-52220
TOYOTA	88310-52380
TOYOTA	88310-52381
TOYOTA	88320-52090
TOYOTA	88410-52080
TOYOTA	88410-52240

DCP50007	OE
TOYOTA	88310-52351
TOYOTA	88320-52400
TOYOTA	88410-52230

DCP50009	OE
TOYOTA	88310-0D070
TOYOTA	88310-0D071

DCP50010	OE
TOYOTA	88310-02270
TOYOTA	88310-02340
TOYOTA	88310-1A620
TOYOTA	88320-52420
TOYOTA	88410-1A330

DCP50011	OE
TOYOTA	88310-02181
TOYOTA	88310-02182
TOYOTA	88310-02251
TOYOTA	88310-02320
TOYOTA	88310-1A582
TOYOTA	88320-1A481
TOYOTA	88410-1A260
TOYOTA	88410-1A290

DCP50012	OE
TOYOTA	88310-1A523
TOYOTA	88320-1A491

DCP50013	OE
TOYOTA	88310-02190
TOYOTA	88310-02191
TOYOTA	88310-02192
TOYOTA	88310-02261
TOYOTA	88310-02262
TOYOTA	88310-02330
TOYOTA	88310-13030
TOYOTA	88310-13032
TOYOTA	88320-1A481
TOYOTA	88320-1A550
TOYOTA	88410-13010
TOYOTA	88410-13020
TOYOTA	88410-13030

DCP50014	OE
TOYOTA	88320-1A470

DCP50015	OE
TOYOTA	88310-02180
TOYOTA	88310-1A580
TOYOTA	88410-1A220

DCP50020	OE
TOYOTA	88310-05040
TOYOTA	88310-63020
TOYOTA	88320-63010

DCP50021	OE
TOYOTA	88310-2B590
TOYOTA	88320-2B400
TOYOTA	88410-21020

DCP50022	OE
TOYOTA	88310-05050
TOYOTA	88320-63020
TOYOTA	88410-05010

DCP50023	OE
TOYOTA	88310-2B550
TOYOTA	88320-2B350
TOYOTA	88410-2B240

DCP50024	OE
TOYOTA	88310-2B560
TOYOTA	88320-2B360
TOYOTA	88320-2BH90
TOYOTA	88410-2B060

DCP50025	OE
TOYOTA	88310-2B640
TOYOTA	88410-33090

DCP50026	OE
TOYOTA	88310-2B660
TOYOTA	88320-2B410
TOYOTA	88410-44050

DCP50030	OE
TOYOTA	88310-42200
TOYOTA	88320-42100
TOYOTA	88410-42070

DCP50031	OE
TOYOTA	88310-42070
TOYOTA	88320-42050
TOYOTA	88410-44010

DCP50032	OE
TOYOTA	88310-42210
TOYOTA	88320-42110
TOYOTA	88410-42060

DCP50033	OE
TOYOTA	88310-42180
TOYOTA	88320-42080
TOYOTA	88410-42080

DCP50035	OE
TOYOTA	88310-42260

DCP50036	OE
TOYOTA	88310-42320

DCP50037	OE
TOYOTA	88310-42310

DCP50039	OE
TOYOTA	88310-0R030
TOYOTA	88310-42270

DCP50040	OE
TOYOTA	88310-06130
TOYOTA	88310-06140
TOYOTA	88310-06150
TOYOTA	88310-06160
TOYOTA	88310-06170
TOYOTA	88310-48040
TOYOTA	88320-48080
TOYOTA	88410-42040

DCP50041	OE
TOYOTA	88310-33220
TOYOTA	88320-48080
TOYOTA	88410-42080

DCP50042	OE
TOYOTA	88310-06240
TOYOTA	88310-06360
TOYOTA	88310-06420
TOYOTA	88310-33250

DCP50050	OE
TOYOTA	88310-2B301
TOYOTA	88310-2B470
TOYOTA	88320-2B300
TOYOTA	88410-2B100

DCP50060	OE
TOYOTA	88310-2B680
TOYOTA	88320-2B420
TOYOTA	88410-32200

DCP50070	OE
TOYOTA	88310-60460

DCP50071	OE
TOYOTA	88310-60770
TOYOTA	88320-60630
TOYOTA	88410-22480

DCP50073	OE
TOYOTA	88310-6A010
TOYOTA	88320-60700
TOYOTA	88410-6A010

DCP50074	OE
TOYOTA	88310-6A100
TOYOTA	88320-60720
TOYOTA	88410-6A010

DCP50076	OE
TOYOTA	88310-6A141
TOYOTA	88320-6A081
TOYOTA	88410-35400

DCP50078	OE
TOYOTA	88310-35710
TOYOTA	88320-35470
TOYOTA	88410-35250

DCP50080	OE
TOYOTA	88310-28550
TOYOTA	88320-28410
TOYOTA	88410-35400

DCP50081	OE
TOYOTA	88310-28450
TOYOTA	88320-28350

DCP50082	OE
TOYOTA	88310-28530

DCP50083	OE
TOYOTA	88310-44220
TOYOTA	88320-44150
TOYOTA	88410-44080

DCP50085	OE
TOYOTA	88310-6A140
TOYOTA	88320-6A080
TOYOTA	88410-35400

DCP50086	OE
TOYOTA	88310-6A060
TOYOTA	88320-6A090
TOYOTA	88410-35410

DCP50087	OE
TOYOTA	88310-0G020
TOYOTA	88310-60850
TOYOTA	88310-60851
TOYOTA	88320-60680
TOYOTA	88320-60681
TOYOTA	88410-50040
TOYOTA	88410-60410

DCP50088	OE
TOYOTA	88310-6A350
TOYOTA	88320-6A320
TOYOTA	88410-6A100

DCP50090	OE
TOYOTA	88310-44140
TOYOTA	88320-44100
TOYOTA	88410-44060

DCP50092	OE
TOYOTA	88310-0K110
TOYOTA	88310-0K111
TOYOTA	88310-0K112
TOYOTA	88310-0K113
TOYOTA	88310-0K190
TOYOTA	88310-0K191
TOYOTA	88310-0K192
TOYOTA	88310-71060
TOYOTA	88310-71061
TOYOTA	88310-71062
TOYOTA	88320-0K460
TOYOTA	88320-0K500
TOYOTA	88320-71110
TOYOTA	88410-0K400
TOYOTA	88410-0K470
TOYOTA	88410-71050

DCP50093	OE
TOYOTA	88310-0K130
TOYOTA	88310-0K131
TOYOTA	88310-0K132
TOYOTA	88320-0K100
TOYOTA	88410-0K210
TOYOTA	88410-0K450
TOYOTA	88410-0K520

DCP50095	OE
TOYOTA	88310-25220
TOYOTA	88320-25110
TOYOTA	88410-28200

DCP50097	OE
TOYOTA	88310-35850
TOYOTA	88320-35720
TOYOTA	88410-35390

DCP50099	OE
TOYOTA	88310-36530

DCP50100	OE
TOYOTA	88310-36212
TOYOTA	88310-36881
TOYOTA	88320-36560
TOYOTA	88410-36520

DCP50101	OE
TOYOTA	88310-0R011
TOYOTA	88310-0R012
TOYOTA	88310-0R013
TOYOTA	88310-0R014
TOYOTA	88310-42331
TOYOTA	88310-42332

DCP50101	OE
TOYOTA	88310-42333
TOYOTA	88310-42334

DCP50102	OE
TOYOTA/LEXUS	88310-35870

DCP50103	OE
TOYOTA/LEXUS	88310-35830
TOYOTA/LEXUS	88320-35700
TOYOTA/LEXUS	88410-35430

DCP50114	OE
TOYOTA	88310-0F010

DCP50115	OE
TOYOTA	88310-52020
TOYOTA	88310-52070
TOYOTA	88320-52010
TOYOTA	88410-52030

DCP50116	OE
TOYOTA	88310-52350
TOYOTA	88320-52120

DCP50120	OE
TOYOTA	88310-05080
TOYOTA	88310-68010

DCP50121	OE
TOYOTA	88310-05090

DCP50122	OE
TOYOTA	88310-05100
TOYOTA	88310-05101
TOYOTA	88310-0F020
TOYOTA	88310-0F021

DCP50123	OE
TOYOTA	88310-05110

DCP50124	OE
TOYOTA	88310-05120
TOYOTA	88310-0F030

DCP50125	OE
TOYOTA	88310-74010
TOYOTA	88310-74012
TOYOTA	88310-74021
TOYOTA	88310-74022
TOYOTA	88320-74010
TOYOTA	88320-74050
TOYOTA	88410-74010
TOYOTA	88410-74040

DCP50126	OE
TOYOTA	88310-74031
TOYOTA	88310-74032
TOYOTA	88320-74030
TOYOTA	88410-74020

DCP50130	OE
TOYOTA	88320-35730
TOYOTA	88410-35400

DCP50131	OE
TOYOTA	88310-6A390
TOYOTA	88320-6A460
TOYOTA	88410-6A180

DCP50132	OE
TOYOTA	88320-6A470

DCP50132	OE
TOYOTA	88410-6A180

DCP50220	OE
TOYOTA	88310-44150
TOYOTA	88320-44120

DCP50221	OE
TOYOTA	88310-44160
TOYOTA	88320-44130

DCP50222	OE
TOYOTA	88310-44170
TOYOTA	88320-44140
TOYOTA	88410-28230

DCP50223	OE
TOYOTA	88310-44180
TOYOTA	88320-44150
TOYOTA	88410-28230

DCP50224	OE
TOYOTA	88310-44200
TOYOTA	88320-44130

DCP50225	OE
TOYOTA	88310-44210
TOYOTA	88320-44140
TOYOTA	88410-44080

DCP50226	OE
TOYOTA	88310-28540
TOYOTA	88320-28370
TOYOTA	88320-28371
TOYOTA	88410-28260

DCP50228	OE
TOYOTA	88310-02690
TOYOTA	88310-05140
TOYOTA	88310-1A770

DCP50240	OE
TOYOTA	88310-0D230
TOYOTA	88310-0D231
TOYOTA	88310-0D232
TOYOTA	88310-52590
TOYOTA	88310-52591
TOYOTA	88310-52592

DCP50241	OE
TOYOTA	88310-52492

DCP50242	OE
TOYOTA	88310-2B720
TOYOTA	88310-2B721

DCP50243	OE
TOYOTA	88310-52600
TOYOTA	88310-52601

DCP50245	OE
TOYOTA	88310-52481

DCP50246	OE
TOYOTA	88310-0D200
TOYOTA	88310-0D201
TOYOTA	88310-0D202

DCP50248	OE
TOYOTA	88310-0D210
TOYOTA	88310-0D211
TOYOTA	88310-0D212

# A/C Components

## Cross Reference Chart - Short Code > OE

DCP50249	OE
TOYOTA	88310-0D241
TOYOTA	88310-0D280
TOYOTA	88310-0D300
TOYOTA	88310-52550
TOYOTA	88310-52551

DCP50250	OE
TOYOTA	88310-0D420

DCP50251	OE
TOYOTA	88310-0D380
TOYOTA	88310-52710

DCP50252	OE
TOYOTA	88310-0D400
TOYOTA	88310-52730

DCP50253	OE
TOYOTA	88310-0D410

DCP50300	OE
TOYOTA	88310-02390
TOYOTA	88310-1A680

DCP50301	OE
TOYOTA	88310-02400
TOYOTA	88310-02480
TOYOTA	88310-42250

DCP50302	OE
TOYOTA	88310-02370
TOYOTA	88310-02450
TOYOTA	88310-02500
TOYOTA	88310-02650
TOYOTA	88310-02680
TOYOTA	88310-1A660

DCP50304	OE
TOYOTA	88310-0D320
TOYOTA	88310-1A800

DCP50305	OE
TOYOTA	88310-02720
TOYOTA	88310-0D330
TOYOTA	88310-1A820

DCP50306	OE
TOYOTA	88310-02540
TOYOTA	88310-1A760

DCP50308	OE
TOYOTA	88310-02830

DCP50309	OE
TOYOTA	88310-02840

DCP50310	OE
TOYOTA	88310-02780

DCP50311	OE
TOYOTA	88310-42370
TOYOTA	88310-42520

DCP50312	OE
TOYOTA	88310-02790
TOYOTA	88310-1A840
TOYOTA	88310-1A841

DCP50313	OE
TOYOTA	88310-02850
TOYOTA	88310-02851

DCP50313	OE
TOYOTA	88310-02852
TOYOTA	88310-02891
TOYOTA	88310-02A10
TOYOTA	88310-02A40
TOYOTA	88310-02A60
TOYOTA	88310-02A80
TOYOTA	88310-42510
TOYOTA	88310-42511

DCP50314	OE
TOYOTA	88310-0F050

DCP50315	OE
SUBARU	73111CA001
SUBARU	73111CA011
TOYOTA/LEXUS	SU003-02115

DCP50316	OE
TOYOTA/LEXUS	88310-02B00
TOYOTA/LEXUS	88310-02B10

DCP50317	OE
TOYOTA	88310-0DA80

DCP50318	OE
TOYOTA	88310-0DA90

DCP50319	OE
TOYOTA	88310-02800

DCP50501	OE
TOYOTA	88370-47060

DCP50502	OE
TOYOTA	88370-47030
TOYOTA	88370-47031
TOYOTA	88370-47032

DCP50503	OE
TOYOTA	88370-47010

DCP50504	OE
TOYOTA	88370-52010
TOYOTA	88370-52011
TOYOTA	88370-52012

DCP51000	OE
TOYOTA	88310-53040
TOYOTA	88320-53020
TOYOTA	88410-53010

DCP51001	OE
TOYOTA	88310-53060

DCP51002	OE
TOYOTA	88310-0N010
TOYOTA	88310-3A430
TOYOTA	88310-3A431
TOYOTA	88320-3A250
TOYOTA	88320-3A300
TOYOTA	88410-3A280
TOYOTA	88410-3A290

DCP51003	OE
TOYOTA	88310-50150
TOYOTA	88310-50151
TOYOTA	88310-50152

DCP51004	OE
LEXUS	88310-50160

DCP51005	OE
TOYOTA	88370-30020
TOYOTA	88370-30021

DCP51006	OE
TOYOTA	88370-30030

DCP51007	OE
TOYOTA	88370-48030

DCP51008	OE
LEXUS	88370-48022

DCP51010	OE
TOYOTA	88370-47050

DCP51011	OE
TOYOTA	88370-76020

DCP51012	OE
LEXUS	88370-33020
TOYOTA	88370-33020

DCP51015	OE
TOYOTA/LEXUS	88310-48011

DCP51016	OE
TOYOTA/LEXUS	88310-48180

DCP99001	OE
JEEP	55036151
JEEP	55036151G

DCP99002	OE
JEEP	56006551
JEEP	56006551H

DCP99003	OE
CHRYSLER	04677445
CHRYSLER	04677445D
CHRYSLER	4677445
CHRYSLER	4677445D
CHRYSLER	4746858
CHRYSLER	55035993
CHRYSLER	55035993AB
CHRYSLER	55035993E

DCP99004	OE
CHRYSLER	55036412
CHRYSLER	55036412B

DCP99005	OE
JEEP	35232010F

DCP99017	OE
TOYOTA	88310-B2220
TOYOTA	88320-B2070
TOYOTA	88410-B1040

DCP99020	OE
HUMMER	20931258
HUMMER	89024882

DCP99023	OE
VDL	30041819

DCP99502	OE
FENDT	G311 550 020 100
FENDT	G311550020100

DCP99504	OE
JOHN DEERE	AZ44541

DCP99505	OE
JOHN DEERE	AL153386
JOHN DEERE	AL154203
JOHN DEERE	AL174136
JOHN DEERE	AL174137
JOHN DEERE	AL176857
JOHN DEERE	AL78779

DCP99510	OE
JOHN DEERE	RE 46609
JOHN DEERE	RE46609
JOHN DEERE	RE69716

DCP99511	OE
JOHN DEERE	AT 172975
JOHN DEERE	AT172975

DCP99512	OE
JOHN DEERE	AL155836

DCP99513	OE
JOHN DEERE	AL176858

DCP99515	OE
JOHN DEERE	RE12514

DCP99517	OE
JOHN DEERE	AH169875

DCP99518	OE
FENDT	G117551020110

DCP99519	OE
DEUTZ	04293225
DEUTZ	4293225

DCP99520	OE
JOHN DEERE	RE284680

DCP99521	OE
JOHN DEERE	RE55422
JOHN DEERE	RE55422A

DCP99522	OE
JOHN DEERE	AT163728

DCP99523	OE
JOHN DEERE	AT226273

DCP99524	OE
JOHN DEERE	MIA10103
TOYOTA	88410-17110

DCP99525	OE
JOHN DEERE	AN221429
JOHN DEERE	RE46609
JOHN DEERE	RE69716

DCP99526	OE
AGCO	ACV0059750
VALTRA	ACV0059750

DCP99527	OE
JOHN DEERE	RE70016

DCP99528	OE
JOHN DEERE	RE196923

DCP99529	OE
JOHN DEERE	MIA10078

# A/C Components

Cross Reference Chart - Short Code > OE

<b>DCP99530</b>	<b>OE</b>
JOHN DEERE	RE46657

<b>DCP99800</b>	<b>OE</b>
CATERPILLAR	24577-79
CATERPILLAR	30503-24

<b>DCP99801</b>	<b>OE</b>
CATERPILLAR	30503-25

<b>DCP99802</b>	<b>OE</b>
CATERPILLAR	17855-45

<b>DCP99803</b>	<b>OE</b>
CATERPILLAR	231-6984

<b>DCP99807</b>	<b>OE</b>
CATERPILLAR	24577-81

<b>DCP99809</b>	<b>OE</b>
CATERPILLAR	25972-44

<b>DCP99810</b>	<b>OE</b>
CATERPILLAR	15404-90

<b>DCP99812</b>	<b>OE</b>
JOHN DEERE	259-7243

<b>DCP99820</b>	<b>OE</b>
KOMATSU	20Y9793110
KOMATSU	20Y-979-3110
KOMATSU	20Y9793111
KOMATSU	20Y-979-3111
KOMATSU	20Y9796121
KOMATSU	20Y-979-6121
KOMATSU	586303245171

<b>DCP99821</b>	<b>OE</b>
KOMATSU	X4436025

<b>DCP99822</b>	<b>OE</b>
KOMATSU	20Y8101260
KOMATSU	20Y81-01260

<b>DCP99823</b>	<b>OE</b>
KOMATSU	14XZ118580
KOMATSU	14X-Z11-8580

<b>DCP99830</b>	<b>OE</b>
KUBOTA	3C58150062
KUBOTA	3C581-50062

<b>DCP99831</b>	<b>OE</b>
KUBOTA	T1065-72213

<b>DCP99832</b>	<b>OE</b>
KUBOTA	T2055-72253

<b>DCP99B03</b>	<b>OE</b>
FENDT	199551020010
FENDT	385551020010
FENDT	G199551020010
FENDT	G385551020010

# A/C Components

## Cross Reference Chart - DENSO > Short Code

DENSO	Short Code
042000-0190	DCP50503
042200-0070	DCP51005
042200-0110	DCP51005
042200-0120	DCP51008
042200-0210	DCP50502
042200-0220	DCP51007
042200-0250	DCP51006
042200-0390	DCP51010
042200-0400	DCP51011
042200-0410	DCP50501
042200-0420	DCP50502
042200-0460	DCP51012
042200-0510	DCP50504
042200-1030	DCP50502
042200-1040	DCP50504
042200-1350	DCP50504
047100-8240	DCP17002
047100-8530	DCP99515
047100-8960	DCP17013
047100-8970	DCP17001
047100-9750	DCP28001
047200-2920	DCP17002
047200-3170	DCP99515
047200-3570	DCP17001
047200-3570	DCP17012
047200-4160	DCP28001
047200-6470	DCP17003
047200-6600	DCP02001
047200-7620	DCP02002
047200-8490	DCP02003
047200-8540	DCP17010
047200-9750	DCP28003
047300-0120	DCP17007
047300-2640	DCP17002
047300-2730	DCP99515
047300-3000	DCP17001
047300-3240	DCP28001
047300-3650	DCP17001
047300-3880	DCP17003
047300-3890	DCP02002
047300-4680	DCP02001
047300-4920	DCP02003
047300-5310	DCP17012
047300-5650	DCP28003
047300-6160	DCP99C00
047300-7140	DCP17012
047300-7150	DCP17013
047300-8470	DCP17011
047300-9640	DCP17010
147100-0350	DCP17033
147100-0750	DCP17001
147100-1430	DCP17003
147100-1600	DCP02001
147100-2890	DCP02002
147100-3570	DCP17033
147100-3900	DCP02003
147100-3960	DCP17010
147100-3970	DCP17011
147100-4760	DCP17012
147100-5020	DCP17012
147100-5430	DCP28003
147100-5690	DCP05012
147100-7510	DCP17012
147100-7520	DCP17013
147100-8500	DCP50070
147100-9980	DCP05003
147200-1240	DCP17011
147200-1380	DCP17012
147200-1380	DCP17013
147200-3330	DCP17007
147200-5630	DCP50070

DENSO	Short Code
147200-7180	DCP17001
147200-7190	DCP17002
147200-7200	DCP17003
147300-0170	DCP50070
147300-0360	DCP02003
247100-3010	DCP17006
247100-3020	DCP17007
247100-4080	DCP02003
247100-5910	DCP17001
247100-5920	DCP17002
247100-5930	DCP17003
247300-0030	DCP45012
247300-0030	DCP45014
247300-0040	DCP45011
247300-0050	DCP17080
247300-0090	DCP50015
247300-0130	DCP05046
247300-0170	DCP14007
247300-0180	DCP14008
247300-0220	DCP06025
247300-0340	DCP12004
247300-0350	DCP12005
247300-0360	DCP40015
247300-0380	DCP17035
247300-0381	DCP17035
247300-0400	DCP17114
247300-0470	DCP23025
247300-0510	DCP99821
247300-0600	DCP50006
247300-0600	DCP50115
247300-0620	DCP09008
247300-0630	DCP09002
247300-0700	DCP50222
247300-0700	DCP50223
247300-0710	DCP20030
247300-0730	DCP06012
247300-0780	DCP50013
247300-0900	DCP17031
247300-0900	DCP17501
247300-0920	DCP99800
247300-0920	DCP99802
247300-0990	DCP05039
247300-1000	DCP05040
247300-1060	DCP11007
247300-1190	DCP50100
247300-1220	DCP09003
247300-1330	DCP40012
247300-1430	DCP05022
247300-1510	DCP17125
247300-1510	DCP17508
247300-1560	DCP50033
247300-1560	DCP50041
247300-1600	DCP99832
247300-1630	DCP99528
247300-1660	DCP50011
247300-1670	DCP06021
247300-1800	DCP06026
247300-1880	DCP12003
247300-1940	DCP50097
247300-1950	DCP50076
247300-1950	DCP50080
247300-1950	DCP50082
247300-1950	DCP50085
247300-1950	DCP50130
247300-1950	DCP50224
247300-1960	DCP50086
247300-1980	DCP50103
247300-2030	DCP50116
247300-2040	DCP50002
247300-2160	DCP50006

DENSO	Short Code
247300-2190	DCP50013
247300-2210	DCP50004
247300-2240	DCP49002
247300-2370	DCP17092
247300-2670	DCP50226
247300-2700	DCP50032
247300-2710	DCP50030
247300-2720	DCP50083
247300-2720	DCP50225
247300-2760	DCP45004
247300-2760	DCP45005
247300-2780	DCP99518
247300-2790	DCP17100
247300-2800	DCP99803
247300-2800	DCP99807
247300-2810	DCP99800
247300-2890	DCP51002
247300-2891	DCP51002
247300-2910	DCP50116
247300-3030	DCP50007
247300-3040	DCP50006
247300-3070	DCP50004
247300-3080	DCP50003
247300-3080	DCP99524
247300-3090	DCP50011
247300-3090	DCP50012
247300-3100	DCP50002
247300-3140	DCP50013
247300-3170	DCP09003
247300-3190	DCP36003
247300-3200	DCP36002
247300-3210	DCP36003
247300-3230	DCP09008
247300-3240	DCP09002
247300-3270	DCP09004
247300-3330	DCP50005
247300-3350	DCP06020
247300-3352	DCP06020
247300-3410	DCP50010
247300-3640	DCP45006
247300-3640	DCP45013
247300-3720	DCP05031
247300-3740	DCP50092
247300-3741	DCP50092
247300-3830	DCP50093
247300-4210	DCP36007
247300-4211	DCP36007
247300-4220	DCP47002
247300-4370	DCP40003
247300-4460	DCP47002
247300-4480	DCP06027
247300-4510	DCP17121
247300-4520	DCP17150
247300-4530	DCP17122
247300-4600	DCP99801
247300-4610	DCP99809
247300-4650	DCP17034
247300-4660	DCP17036
247300-4660	DCP17C36
247300-4670	DCP17092
247300-4680	DCP17035
247300-4690	DCP99822
247300-4710	DCP06027
247300-4860	DCP36001
247300-4860	DCP36002
247300-4980	DCP99830
247300-5030	DCP49001
247300-5031	DCP49001
247300-5040	DCP99017
247300-5100	DCP51002
247300-5140	DCP99022

DENSO	Short Code
247300-5170	DCP32067
247300-5180	DCP99519
247300-5200	DCP05034
247300-5200	DCP05082
247300-5210	DCP05102
247300-5230	DCP05083
247300-5230	DCP05088
247300-5230	DCP05093
247300-5240	DCP05108
247300-5250	DCP05050
247300-5270	DCP40004
247300-5360	DCP17K37
247300-5510	DCP23530
247300-5510	DCP23531
247300-5510	DCP23537
247300-5510	DCP99505
247300-5510	DCP99513
247300-5670	DCP50088
247300-5820	DCP06029
247300-5821	DCP06029
247300-6090	DCP99801
247300-6100	DCP99800
247300-6130	DCP05076
247300-6210	DCP40018
247300-6220	DCP09003
247300-6240	DCP99517
247300-6250	DCP01015
247300-6250	DCP09008
247300-6260	DCP13010
247300-6270	DCP05077
247300-6290	DCP05081
247300-6320	DCP05022
247300-6490	DCP50092
247300-6491	DCP50092
247300-6540	DCP50093
247300-6700	DCP11008
247300-6730	DCP09002
247300-6740	DCP09007
247300-6750	DCP09005
247300-6760	DCP09001
247300-6800	DCP50092
247300-6850	DCP50093
247300-6870	DCP50125
247300-6871	DCP50125
247300-6890	DCP50126
247300-7140	DCP36004
247300-7170	DCP17157
247300-7310	DCP50131
247300-7310	DCP50132
247300-7420	DCP05095
247300-7420	DCP05096
247300-7570	DCP50125
247300-7650	DCP17140
247300-7650	DCP17148
247300-7660	DCP17176
247300-7690	DCP05078
247300-7840	DCP99520
247300-7920	DCP09060
247300-7930	DCP09061
247300-7970	DCP17140
247300-7970	DCP17154
247300-8070	DCP05095
247300-8070	DCP05096
247300-8070	DCP05104
247300-8070	DCP05106
247300-8070	DCP05115
247300-8120	DCP05078
247300-8130	DCP17186
247300-8140	DCP17185
247300-8200	DCP17181
247300-8220	DCP12012

DENSO	Short Code
247300-8310	DCP45009
247300-8360	DCP99023
247300-8390	DCP02098
247300-8390	DCP02101
247300-8690	DCP40017
247300-8990	DCP23034
247300-9000	DCP23035
247300-9240	DCP17178
247300-9250	DCP17169
247300-9260	DCP17177
247300-9270	DCP17155
247300-9280	DCP17179
247300-9700	DCP46020
247300-9720	DCP46021
247300-9730	DCP46020
247300-9740	DCP46022
247300-9900	DCP17151
247400-0530	DCP23539
247400-0530	DCP23541
247400-0540	DCP23540
247400-1290	DCP02098
247400-1290	DCP02101
247400-1290	DCP02110
247400-1390	DCP99526
247400-1490	DCP02110
248300-0010	DCP17153
248300-0020	DCP17026
248300-0040	DCP05021
248300-0050	DCP05094
248300-0060	DCP05107
248300-0070	DCP32031
248300-0070	DCP32052
248300-0070	DCP32055
248300-0071	DCP32031
248300-0080	DCP50001
248300-0080	DCP50009
248300-0110	DCP17050
248300-0120	DCP17043
248300-0120	DCP17085
248300-0130	DCP17041
248300-0140	DCP50121
248300-0143	DCP50121
248300-0150	DCP32023
248300-0150	DCP32051
248300-0160	DCP17026
248300-0170	DCP11011
248300-0170	DCP11045
248300-0180	DCP11010
248300-0210	DCP32006
248300-0210	DCP32006K
248300-0220	DCP28010
248300-0230	DCP17039
248300-0230	DCP17043
248300-0230	DCP17045
248300-0230	DCP17055
248300-0230	DCP17059
248300-0230	DCP17060
248300-0230	DCP17102
248300-0230	DCP17160
248300-0231	DCP17043
248300-0231	DCP17045
248300-0240	DCP17058
248300-0240	DCP17067
248300-0240	DCP17102
248300-0240	DCP17131
248300-0250	DCP17026
248300-0250	DCP17046
248300-0250	DCP17053
248300-0250	DCP17058
248300-0250	DCP17064
248300-0250	DCP17065

DENSO	Short Code
248300-0250	DCP17068
248300-0250	DCP17133
248300-0250	DCP17135
248300-0250	DCP17139
248300-0250	DCP17142
248300-0251	DCP17064
248300-0251	DCP17139
248300-0251	DCP17142
248300-0260	DCP02015
248300-0260	DCP02055
248300-0260	DCP02104
248300-0260	DCP32062
248300-0260	DCP32071
248300-0261	DCP32071
248300-0270	DCP32003
248300-0290	DCP17051
248300-0300	DCP02009
248300-0300	DCP32021
248300-0310	DCP05038
248300-0320	DCP50120
248300-0322	DCP50120
248300-0390	DCP32003
248300-0400	DCP05021
248300-0400	DCP05052
248300-0410	DCP05020
248300-0450	DCP32003
248300-0450	DCP32045
248300-0480	DCP05107
248300-0510	DCP02014
248300-0510	DCP02035
248300-0510	DCP02038
248300-0510	DCP02052
248300-0520	DCP17070
248300-0550	DCP50120
248300-0580	DCP51003
248300-0590	DCP17071
248300-0600	DCP05032
248300-0600	DCP05045
248300-0600	DCP05079
248300-0610	DCP32005
248300-0610	DCP32020
248300-0630	DCP17054
248300-0650	DCP50122
248300-0650	DCP50123
248300-0660	DCP50114
248300-0660	DCP50120
248300-0660	DCP50248
248300-0670	DCP05026
248300-0670	DCP05037
248300-0710	DCP02016
248300-0710	DCP02034
248300-0720	DCP02014
248300-0740	DCP17038
248300-0740	DCP17051
248300-0740	DCP17103
248300-0750	DCP17056
248300-0760	DCP14012
248300-0770	DCP14013
248300-0770	DCP14020
248300-0780	DCP14014
248300-0780	DCP14019
248300-0790	DCP02039
248300-0800	DCP02028
248300-0870	DCP17046
248300-0870	DCP17062
248300-0870	DCP17063
248300-0870	DCP17146
248300-0880	DCP17054
248300-0940	DCP32021
248300-0950	DCP09017
248300-0950	DCP13005

DENSO	Short Code
248300-0960	DCP09016
248300-0960	DCP09062
248300-0980	DCP05042
248300-0980	DCP05094
248300-0990	DCP05052
248300-0990	DCP05080
248300-0990	DCP05084
248300-1010	DCP32022
248300-1020	DCP02033
248300-1020	DCP02036
248300-1030	DCP50304
248300-1032	DCP50304
248300-1060	DCP11012
248300-1070	DCP05032
248300-1070	DCP05045
248300-1080	DCP02035
248300-1080	DCP02037
248300-1080	DCP02038
248300-1080	DCP02052
248300-1090	DCP05020
248300-1100	DCP50124
248300-1150	DCP17073
248300-1150	DCP32045
248300-1190	DCP17067
248300-1190	DCP17086
248300-1190	DCP17138
248300-1200	DCP06022
248300-1210	DCP17062
248300-1210	DCP17063
248300-1210	DCP17143
248300-1210	DCP17146
248300-1220	DCP20022
248300-1230	DCP05032
248300-1230	DCP05036
248300-1230	DCP05045
248300-1240	DCP02014
248300-1240	DCP02038
248300-1260	DCP50301
248300-1260	DCP51001
248300-1270	DCP05093
248300-1270	DCP06022
248300-1290	DCP50039
248300-1300	DCP50035
248300-1310	DCP50240
248300-1310	DCP50246
248300-1320	DCP05026
248300-1330	DCP45003
248300-1370	DCP50245
248300-1380	DCP50122
248300-1380	DCP50123
248300-1390	DCP50042
248300-1410	DCP51004
248300-1411	DCP51004
248300-1430	DCP50248
248300-1434	DCP50248
248300-1490	DCP50114
248300-1491	DCP50120
248300-1560	DCP50241
248300-1560	DCP50249
248300-1570	DCP17102
248300-1580	DCP50036
248300-1580	DCP50302
248300-1581	DCP50036
248300-1590	DCP50300
248300-1600	DCP02030
248300-1600	DCP02090
248300-1600	DCP02092
248300-1600	DCP02096
248300-1650	DCP02033
248300-1680	DCP02014
248300-1680	DCP02038

DENSO	Short Code
248300-1680	DCP02040
248300-1680	DCP02041
248300-1680	DCP02060
248300-1680	DCP02063
248300-1690	DCP02035
248300-1690	DCP02037
248300-1690	DCP02038
248300-1690	DCP02065
248300-1690	DCP32063
248300-1700	DCP02039
248300-1710	DCP02016
248300-1710	DCP02034
248300-1720	DCP02033
248300-1720	DCP02036
248300-1720	DCP02043
248300-1720	DCP32064
248300-1740	DCP05033
248300-1750	DCP50246
248300-1780	DCP05020
248300-1780	DCP05035
248300-1780	DCP05092
248300-1790	DCP02042
248300-1790	DCP02044
248300-1800	DCP02043
248300-1810	DCP17104
248300-1810	DCP17128
248300-1820	DCP17087
248300-1820	DCP17100
248300-1820	DCP17112
248300-1820	DCP17120
248300-1830	DCP17115
248300-1840	DCP20021
248300-1840	DCP20021K
248300-1840	DCP20122
248300-1850	DCP20022
248300-1860	DCP02016
248300-1860	DCP02027
248300-1860	DCP02028
248300-1870	DCP50306
248300-1871	DCP50306
248300-1890	DCP05060
248300-1900	DCP17073
248300-1900	DCP17084
248300-1900	DCP32045
248300-1910	DCP32005
248300-1910	DCP32020
248300-1920	DCP32021
248300-1930	DCP05061
248300-1980	DCP17072
248300-1990	DCP07010
248300-1990	DCP21014
248300-1990	DCP21021
248300-2000	DCP50243
248300-2020	DCP50037
248300-2020	DCP50228
248300-2060	DCP32022
248300-2070	DCP02050
248300-2110	DCP09020
248300-2110	DCP09032
248300-2110	DCP09063
248300-2120	DCP02052
248300-2130	DCP05062
248300-2140	DCP20023
248300-2170	DCP50242
248300-2180	DCP28012
248300-2190	DCP17105
248300-2220	DCP50240
248300-2230	DCP23030
248300-2240	DCP23031
248300-2260	DCP17171
248300-2260	DCP23032



DENSO	Short Code
248300-2380	DCP17058
248300-2380	DCP17107
248300-2380	DCP17129
248300-2380	DCP17130
248300-2380	DCP17132
248300-2390	DCP17055
248300-2390	DCP17059
248300-2390	DCP17060
248300-2400	DCP02092
248300-2430	DCP17143
248300-2440	DCP17131
248300-2450	DCP17070
248300-2490	DCP50101
248300-2500	DCP17132
248300-2510	DCP17060
248300-2550	DCP50305
248300-2560	DCP17152
248300-2570	DCP02042
248300-2580	DCP02052
248300-2600	DCP17071
248300-2620	DCP05080
248300-2630	DCP17106
248300-2650	DCP28014
248300-2650	DCP28017
248300-2660	DCP36002
248300-2680	DCP02042
248300-2680	DCP32071
248300-2682	DCP32071
248300-2690	DCP02095
248300-2700	DCP02034
248300-2700	DCP02103
248300-2700	DCP02105
248300-2730	DCP32050
248300-2730	DCP32070
248300-2730	DCP32072
248300-2730	DCP32073
248300-2732	DCP32050
248300-2732	DCP32072
248300-2750	DCP28016
248300-2770	DCP32065
248300-2770	DCP32066
248300-2770	DCP32069
248300-2780	DCP17104
248300-2780	DCP17128
248300-2790	DCP17087
248300-2790	DCP17112
248300-2790	DCP17120
248300-2790	DCP17165
248300-2800	DCP17101
248300-2800	DCP17115
248300-2810	DCP17112
248300-2810	DCP17126
248300-2810	DCP17161
248300-2810	DCP17162
248300-2812	DCP17126
248300-2820	DCP17127
248300-2820	DCP17156
248300-2820	DCP17159
248300-2820	DCP17166
248300-2822	DCP17127
248300-2822	DCP17156
248300-2850	DCP17073
248300-2850	DCP32045
248300-2880	DCP05091
248300-2940	DCP17109
248300-2950	DCP50101
248300-2950	DCP50312
248300-2950	DCP50313
248300-2951	DCP50101
248300-2960	DCP05089
248300-2990	DCP05098

DENSO	Short Code
248300-2990	DCP05099
248300-2990	DCP05105
248300-3000	DCP05097
248300-3000	DCP05114
248300-3010	DCP05090
248300-3020	DCP02095
248300-3020	DCP02097
248300-3020	DCP02099
248300-3020	DCP02102
248300-3020	DCP32061
248300-3021	DCP32061
248300-3040	DCP07010
248300-3040	DCP21014
248300-3040	DCP21021
248300-3050	DCP50252
248300-3060	DCP50251
248300-3060	DCP50318
248300-3080	DCP21015
248300-3100	DCP32068
248300-3110	DCP17158
248300-3110	DCP17164
248300-3110	DCP17167
248300-3110	DCP17168
248300-3111	DCP17158
248300-3120	DCP17163
248300-3120	DCP17182
248300-3140	DCP32060
248300-3160	DCP21017
248300-3160	DCP21021
248300-3180	DCP32056
248300-3181	DCP32056
248300-3200	DCP50250
248300-3200	DCP50308
248300-3200	DCP50319
248300-3210	DCP50253
248300-3210	DCP50309
248300-3210	DCP50317
248300-3230	DCP50101
248300-3230	DCP50310
248300-3230	DCP50312
248300-3230	DCP50313
248300-3260	DCP21016
248300-3260	DCP21022
248300-3260	DCP21024
248300-3270	DCP50311
248300-3370	DCP28018
248300-3380	DCP09032
248300-3380	DCP09034
248300-3380	DCP09064
248300-3410	DCP50314
248300-3490	DCP47009
248300-3490	DCP47010
248300-3500	DCP20122
248300-3510	DCP20121
248300-3520	DCP20120
248300-3570	DCP50311
248300-3670	DCP02106
437100-5010	DCP99807
437100-5020	DCP99800
437100-5030	DCP99801
437100-5040	DCP99809
437100-5050	DCP99505
437100-5060	DCP99504
437100-5070	DCP99522
437100-5080	DCP99517
437100-5090	DCP05001
437100-5100	DCP05003
437100-5110	DCP05004
437100-5120	DCP05006
437100-5130	DCP05007
437100-5140	DCP05008

DENSO	Short Code
437100-5150	DCP05009
437100-5160	DCP05010
437100-5170	DCP05012
437100-5180	DCP05022
437100-5190	DCP05026
437100-5200	DCP05061
437100-5210	DCP05062
437100-5220	DCP05014
437100-5230	DCP05016
437100-5240	DCP05018
437100-5250	DCP05019
437100-5260	DCP05039
437100-5270	DCP05017
437100-5280	DCP05060
437100-5290	DCP05042
437100-5300	DCP05094
437100-5310	DCP05038
437100-5340	DCP14012
437100-5350	DCP27002
437100-5360	DCP32020
437100-5370	DCP32005
437100-5380	DCP32056
437100-5390	DCP32052
437100-5400	DCP32023
437100-5410	DCP32003
437100-5420	DCP32031
437100-5430	DCP32006
437100-5440	DCP32022
437100-5450	DCP32051
437100-5460	DCP32021
437100-5470	DCP09016
437100-5480	DCP09020
437100-5490	DCP13001
437100-5500	DCP01001
437100-5510	DCP09005
437100-5520	DCP09007
437100-5540	DCP09009
437100-5550	DCP09006
437100-5570	DCP02023
437100-5580	DCP02008
437100-5590	DCP02012
437100-5600	DCP02061
437100-5610	DCP02024
437100-5620	DCP02007
437100-5630	DCP02039
437100-5640	DCP02028
437100-5660	DCP02092
437100-5670	DCP02063
437100-5680	DCP02065
437100-5690	DCP02030
437100-5710	DCP02060
437100-5720	DCP02004
437100-5730	DCP02006
437100-5740	DCP32001
437100-5750	DCP02005
437100-5760	DCP02047
437100-5770	DCP02026
437100-5780	DCP02091
437100-5790	DCP02025
437100-5800	DCP02009
437100-5810	DCP02015
437100-5820	DCP02027
437100-5830	DCP02034
437100-5840	DCP23530
437100-5850	DCP28008
437100-5860	DCP28012
437100-5870	DCP28016
437100-5880	DCP28010
437100-5890	DCP17021
437100-5900	DCP17033
437100-5910	DCP17505

DENSO	Short Code
437100-5920	DCP17031
437100-5930	DCP17084
437100-5940	DCP17034
437100-5950	DCP17092
437100-5960	DCP17012
437100-5970	DCP17013
437100-5980	DCP17095
437100-5990	DCP17501
437100-6000	DCP17010
437100-6010	DCP17011
437100-6020	DCP17019
437100-6030	DCP17020
437100-6040	DCP17006
437100-6050	DCP17005
437100-6060	DCP17008
437100-6070	DCP17007
437100-6080	DCP17015
437100-6090	DCP17017
437100-6100	DCP17114
437100-6110	DCP06012
437100-6120	DCP17121
437100-6130	DCP17122
437100-6140	DCP17140
437100-6150	DCP17025
437100-6160	DCP17087
437100-6170	DCP17100
437100-6180	DCP17067
437100-6190	DCP17068
437100-6200	DCP17105
437100-6210	DCP17071
437100-6220	DCP17107
437100-6230	DCP17112
437100-6240	DCP17103
437100-6250	DCP17115
437100-6260	DCP17101
437100-6270	DCP17104
437100-6280	DCP17128
437100-6290	DCP17023
437100-6300	DCP17080
437100-6310	DCP17125
437100-6320	DCP17036
437100-6330	DCP17113
437100-6340	DCP17144
437100-6360	DCP17085
437100-6370	DCP17026
437100-6380	DCP17038
437100-6390	DCP17039
437100-6400	DCP17109
437100-6410	DCP17102
437100-6430	DCP25001
437100-6440	DCP12008
437100-6450	DCP12005
437100-6590	DCP17051
437100-6600	DCP17046
437100-6610	DCP17050
437100-6620	DCP17143
437100-6630	DCP17135
437100-6640	DCP05091
437100-6650	DCP05050
437100-6660	DCP05036
437100-6670	DCP05084
437100-6680	DCP17146
437100-6690	DCP05080
437100-6700	DCP05092
437100-6710	DCP05035
437100-6720	DCP05089
437100-6730	DCP05090
437100-6740	DCP05106
437100-6750	DCP05077
437100-6760	DCP05104
437100-6770	DCP05082

DENSO	Short Code
437100-6780	DCP05034
437100-6790	DCP05093
437100-6800	DCP05083
437100-6810	DCP05088
437100-6820	DCP05078
437100-6830	DCP05098
437100-6840	DCP05105
437100-6850	DCP02016
437100-6860	DCP05079
437100-6870	DCP05032
437100-6880	DCP05045
437100-6890	DCP05052
437100-6900	DCP05020
437100-6910	DCP05076
437100-6920	DCP05037
437100-6930	DCP05021
437100-6940	DCP05033
437100-6950	DCP05031
437100-6960	DCP32045
437100-6970	DCP02041
437100-6980	DCP05081
437100-6990	DCP05096
437100-7000	DCP05097
437100-7010	DCP32060
437100-7020	DCP02090
437100-7030	DCP02014
437100-7040	DCP02038
437100-7050	DCP02040
437100-7060	DCP17133
437100-7070	DCP02035
437100-7080	DCP17130
437100-7090	DCP17058
437100-7100	DCP17059
437100-7110	DCP17062
437100-7120	DCP17126
437100-7130	DCP17127
437100-7140	DCP17060
437100-7150	DCP17132
437100-7160	DCP17131
437100-7170	DCP17138
437100-7180	DCP02037
437100-7190	DCP02052
437100-7200	DCP02036
437100-7210	DCP17043
437100-7220	DCP17045
437100-7230	DCP17070
437100-7240	DCP14014
437100-7250	DCP32050
437100-7260	DCP99510
437100-7260	DCP99525
437100-7270	DCP05108
437100-7280	DCP11010
437100-7290	DCP11012
437100-7300	DCP17152
437100-7310	DCP17156
437100-7320	DCP17153
437100-7330	DCP32063
437100-7340	DCP32069
437100-7350	DCP32071
437100-7360	DCP32062
437100-7370	DCP32061
437100-7380	DCP32067
437100-7390	DCP32068
437100-7400	DCP02095
437100-7410	DCP02043
437100-7420	DCP32066
437100-7430	DCP32065
437100-7440	DCP17148
437100-7450	DCP11011
437100-7470	DCP32070
437100-7480	DCP28017

DENSO	Short Code
437100-7490	DCP02096
437100-7500	DCP32064
437100-7510	DCP05107
437100-7520	DCP14019
437100-7530	DCP17151
437100-7540	DCP99521
437100-7550	DCP14018
437100-7560	DCP99523
437100-7570	DCP17147
437100-7580	DCP17150
437100-7600	DCP49002
437100-7610	DCP99524
437100-7620	DCP99017
437100-7630	DCP17001
437100-7640	DCP17003
437100-7650	DCP02001
437100-7660	DCP02003
437100-7670	DCP99515
437100-7740	DCP49001
437100-7780	DCP02033
437100-7790	DCP02042
437100-7800	DCP17014
437100-7810	DCP17106
437100-7820	DCP17120
437100-7830	DCP05013
437100-7840	DCP11007
437100-7850	DCP99511
437100-7860	DCP99513
437100-7870	DCP28014
437100-7880	DCP24005
437100-7890	DCP27001
437100-7940	DCP12012
437100-7950	DCP17035
437100-7960	DCP14013
437100-7970	DCP17K37
437100-7980	DCP02044
437100-7990	DCP17155
437100-8000	DCP20004
437100-8010	DCP02097
437100-8020	DCP02099
437100-8030	DCP02098
437100-8040	DCP17154
437100-8050	DCP32072
437100-8060	DCP17157
437100-8070	DCP20001
437100-8080	DCP99502
437100-8110	DCP17053
437100-8120	DCP17142
437100-8130	DCP17064
437100-8140	DCP17065
437100-8150	DCP17139
437100-8160	DCP17063
437100-8170	DCP17129
437100-8180	DCP17055
437100-8190	DCP05095
437100-8200	DCP05099
437100-8210	DCP02050
437100-8220	DCP17073
437100-8240	DCP06025
437100-8250	DCP99520
437100-8260	DCP02048
437100-8270	DCP02010
437100-8280	DCP02045
437100-8290	DCP02055
437100-8310	DCP02101
437100-8320	DCP02102
437100-8330	DCP17158
437100-8340	DCP21015
437100-8380	DCP17168
437100-8400	DCP02103
437100-8410	DCP02104

DENSO	Short Code
437100-8420	DCP17164
437100-8430	DCP17167
437100-8440	DCP17159
437100-8450	DCP17165
437100-8460	DCP17161
437100-8470	DCP17162
437100-8480	DCP17163
437100-8590	DCP02105
437100-8600	DCP17166
437100-8610	DCP17177
437100-8620	DCP17112
437100-8630	DCP17169
437100-8640	DCP17176
437100-8680	DCP06020
437100-8760	DCP24004
437100-8960	DCP17160
437100-8980	DCP28018
437100-8990	DCP20021
437100-8990	DCP20021K
437100-9000	DCP20022
437100-9010	DCP20023
437100-9020	DCP23034
437100-9030	DCP23035
437100-9080	DCP32073
437100-9090	DCP17185
437100-9100	DCP17178
437100-9110	DCP14020
437100-9130	DCP17179
437100-9140	DCP17180
437100-9150	DCP17181
437100-9160	DCP17182
437100-9180	DCP17186
437100-9860	DCP02106
437100-9890	DCP02107
437100-9900	DCP02108
437100-9960	DCP46024
437140-0010	DCP99530
437140-0030	DCP02110
437140-0060	DCP46025
437140-0080	DCP23539
437140-0090	DCP23540
437140-0100	DCP23541
437140-0130	DCP05115
437140-0140	DCP46020
437140-0150	DCP46021
437140-0160	DCP46022
437140-0170	DCP99527
437140-0180	DCP99528
437140-0190	DCP99812
437150-0010	DCP28019
437150-0080	DCP21023
437150-0110	DCP32074
437150-0120	DCP32075
437150-0130	DCP32076
437150-0140	DCP02109
437150-0150	DCP32077
437150-0160	DCP05114
437150-0170	DCP17171
442100-0120	DCP09007
442100-0240	DCP12001
442100-0280	DCP09005
442100-0290	DCP23002
442100-1020	DCP09001
442100-3160	DCP09003
442100-3200	DCP50013
442100-3200	DCP50015
442100-3370	DCP09060
442100-4000	DCP09004
442100-4030	DCP09061
442500-2130	DCP09006
442500-2130	DCP09011

DENSO	Short Code
442500-2150	DCP09009
442500-2210	DCP09010
442500-2810	DCP36006
442500-4210	DCP09012
442500-4230	DCP09015
442500-4250	DCP09014
442500-4600	DCP36005
446300-7890	DCP17C36
447100-0020	DCP09012
447100-0030	DCP09015
447100-0420	DCP09010
447100-0950	DCP09009
447100-0960	DCP09006
447100-1030	DCP09011
447100-1180	DCP09011
447100-1520	DCP12001
447100-1530	DCP09014
447100-1560	DCP09005
447100-1610	DCP36005
447100-1870	DCP09004
447100-1930	DCP50013
447100-1950	DCP50015
447100-2010	DCP17006
447100-2020	DCP17007
447100-2030	DCP17008
447100-2060	DCP17010
447100-2070	DCP17011
447100-2110	DCP99002
447100-2160	DCP17033
447100-2190	DCP17012
447100-2200	DCP17013
447100-2280	DCP05001
447100-2320	DCP99505
447100-2330	DCP28004
447100-2350	DCP28006
447100-2380	DCP99510
447100-2400	DCP24001
447100-2430	DCP06001
447100-2480	DCP17014
447100-2490	DCP99530
447100-2600	DCP05003
447100-2610	DCP05004
447100-2650	DCP17015
447100-2700	DCP50099
447100-2810	DCP47008
447100-2830	DCP05006
447100-2940	DCP99001
447100-2990	DCP99504
447100-3020	DCP17005
447100-3120	DCP99001
447100-3130	DCP99002
447100-3150	DCP05003
447100-3160	DCP05010
447100-3170	DCP05007
447100-3210	DCP17095
447100-3280	DCP14001
447100-3290	DCP14002
447100-3300	DCP14003
447100-3360	DCP20001
447100-3460	DCP99820
447100-3470	DCP99003
447100-3830	DCP99521
447100-4080	DCP06002
447100-4190	DCP99522
447100-4440	DCP17147
447100-4443	DCP17147
447100-4540	DCP45010
447100-4980	DCP13001
447100-5050	DCP99502
447100-5540	DCP05008
447100-5720	DCP05009

# A/C Components

## Cross Reference Chart - DENSO > Short Code

DENSO	Short Code
447100-5960	DCP50050
447100-6030	DCP17084
447100-6260	DCP11001
447100-6290	DCP99004
447100-6380	DCP17034
447100-6590	DCP06003
447100-6610	DCP06005
447100-6620	DCP06006
447100-6820	DCP17023
447100-7040	DCP50071
447100-7130	DCP05012
447100-7430	DCP17017
447100-7450	DCP17147
447100-7470	DCP05018
447100-7590	DCP05017
447100-7600	DCP05019
447100-7720	DCP17017
447100-7770	DCP20003
447100-7860	DCP23538
447100-7920	DCP02005
447100-8080	DCP06009
447100-8330	DCP50078
447100-8430	DCP11002
447100-8530	DCP99515
447100-8620	DCP17019
447100-8630	DCP17020
447100-8740	DCP50023
447100-8750	DCP50024
447100-9040	DCP05010
447100-9110	DCP28008
447100-9230	DCP17023
447100-9270	DCP02006
447100-9440	DCP02004
447100-9500	DCP32001
447100-9510	DCP20006
447100-9620	DCP14004
447100-9630	DCP14005
447100-9750	DCP12008
447100-9790	DCP99511
447100-9810	DCP25001
447100-9950	DCP17021
447140-0340	DCP02098
447140-0360	DCP02101
447140-0370	DCP02110
447140-0450	DCP05081
447140-0460	DCP05095
447140-0520	DCP47013
447140-0590	DCP02005
447140-0620	DCP99526
447140-0640	DCP02006
447140-1230	DCP05096
447140-1270	DCP47012
447140-1580	DCP05078
447140-1760	DCP46025
447150-0010	DCP23031
447150-0020	DCP23030
447150-0040	DCP23032
447150-0080	DCP28012
447150-0090	DCP17152
447150-0096	DCP17152
447150-0100	DCP02010
447150-0110	DCP02011
447150-0120	DCP02027
447150-0130	DCP05107
447150-0140	DCP05079
447150-0150	DCP05032
447150-0160	DCP05045
447150-0170	DCP17051
447150-0180	DCP17046
447150-0210	DCP17105
447150-0220	DCP07010

DENSO	Short Code
447150-0230	DCP17059
447150-0240	DCP17062
447150-0250	DCP17138
447150-0260	DCP17058
447150-0270	DCP17055
447150-0280	DCP17063
447150-0300	DCP17129
447150-0310	DCP50242
447150-0320	DCP50243
447150-0330	DCP50240
447150-0332	DCP50246
447150-0340	DCP50248
447150-0350	DCP50240
447150-0370	DCP17070
447150-0380	DCP17071
447150-0390	DCP05052
447150-0420	DCP17067
447150-0430	DCP17067
447150-0450	DCP17038
447150-0460	DCP17038
447150-0470	DCP17038
447150-0490	DCP17053
447150-0500	DCP17045
447150-0520	DCP17055
447150-0530	DCP17063
447150-0550	DCP02061
447150-0560	DCP02012
447150-0570	DCP02043
447150-0580	DCP02025
447150-0590	DCP02025
447150-0600	DCP02026
447150-0610	DCP06022
447150-0620	DCP06022
447150-0630	DCP05080
447150-0660	DCP02092
447150-0670	DCP05079
447150-0680	DCP17107
447150-0690	DCP17130
447150-0700	DCP17060
447150-0720	DCP17139
447150-0730	DCP17112
447150-0770	DCP50101
447150-0780	DCP02090
447150-0790	DCP50037
447150-0800	DCP50036
447150-0801	DCP50036
447150-0810	DCP17106
447150-0820	DCP17132
447150-0840	DCP17131
447150-0850	DCP17143
447150-0860	DCP32063
447150-0870	DCP17120
447150-0890	DCP17109
447150-0900	DCP17112
447150-0920	DCP02052
447150-0930	DCP02042
447150-0960	DCP17146
447150-0970	DCP05020
447150-0980	DCP05079
447150-0990	DCP05092
447150-1000	DCP17067
447150-1010	DCP17133
447150-1020	DCP17059
447150-1080	DCP50242
447150-1130	DCP50304
447150-1140	DCP50305
447150-1150	DCP13005
447150-1160	DCP02043
447150-1190	DCP02023
447150-1200	DCP02024
447150-1230	DCP02015

DENSO	Short Code
447150-1240	DCP17059
447150-1250	DCP17062
447150-1260	DCP17058
447150-1380	DCP11045
447150-1390	DCP11010
447150-1420	DCP36002
447150-1430	DCP05033
447150-1450	DCP02060
447150-1490	DCP28014
447150-1520	DCP32050
447150-1530	DCP32069
447150-1540	DCP32071
447150-1549	DCP32071
447150-1550	DCP32062
447150-1570	DCP02036
447150-1580	DCP02037
447150-1590	DCP02035
447150-1600	DCP02065
447150-1610	DCP28010
447150-1620	DCP02042
447150-1630	DCP28016
447150-1640	DCP50240
447150-1660	DCP05091
447150-1670	DCP17068
447150-1680	DCP17102
447150-1690	DCP02038
447150-1700	DCP02016
447150-1710	DCP02014
447150-1720	DCP02063
447150-1730	DCP21021
447150-1740	DCP21014
447150-1750	DCP07010
447150-1760	DCP02095
447150-1770	DCP02034
447150-1790	DCP14020
447150-1850	DCP17126
447150-1860	DCP17127
447150-1870	DCP50101
447150-1872	DCP50101
447150-1880	DCP02033
447150-1890	DCP02033
447150-1900	DCP02039
447150-1910	DCP02040
447150-1920	DCP02041
447150-1930	DCP02030
447150-1940	DCP17026
447150-1970	DCP17143
447150-1980	DCP17060
447150-1990	DCP17065
447150-2010	DCP17142
447150-2090	DCP17159
447150-2100	DCP05089
447150-2130	DCP17103
447150-2140	DCP17115
447150-2150	DCP17087
447150-2160	DCP17128
447150-2170	DCP17041
447150-2190	DCP17160
447150-2200	DCP17039
447150-2210	DCP17072
447150-2220	DCP32020
447150-2230	DCP32005
447150-2240	DCP05090
447150-2300	DCP17161
447150-2320	DCP50251
447150-2340	DCP02103
447150-2350	DCP02099
447150-2360	DCP32061
447150-2367	DCP32061
447150-2400	DCP28019
447150-2410	DCP32022

DENSO	Short Code
447150-2420	DCP32071
447150-2424	DCP32071
447150-2430	DCP32055
447150-2440	DCP32064
447150-2450	DCP02096
447150-2460	DCP50252
447150-2600	DCP32065
447150-2610	DCP32072
447150-2617	DCP32072
447150-2620	DCP05097
447150-2660	DCP05098
447150-2670	DCP05099
447150-2700	DCP17135
447150-2720	DCP17026
447150-2740	DCP17026
447150-2750	DCP17085
447150-2760	DCP17064
447150-2780	DCP17026
447150-2790	DCP17043
447150-2820	DCP17039
447150-2830	DCP17102
447150-2840	DCP05042
447150-2870	DCP02050
447150-2880	DCP32068
447150-2930	DCP32070
447150-2938	DCP32070
447150-2940	DCP32066
447150-2970	DCP17162
447150-2980	DCP17163
447150-3040	DCP17051
447150-3050	DCP17101
447150-3060	DCP17100
447150-3070	DCP17104
447150-3080	DCP17060
447150-3110	DCP17102
447150-3200	DCP50101
447150-3250	DCP21021
447150-3260	DCP17158
447150-3266	DCP17158
447150-3270	DCP17164
447150-3300	DCP50253
447150-3310	DCP02107
447150-3320	DCP02108
447150-3330	DCP50251
447150-3350	DCP50252
447150-3351	DCP50252
447150-3360	DCP50101
447150-3361	DCP50101
447150-3370	DCP32056
447150-3400	DCP17046
447150-3410	DCP17038
447150-3420	DCP17108
447150-3430	DCP17038
447150-3440	DCP17105
447150-3470	DCP17059
447150-3480	DCP17058
447150-3490	DCP17055
447150-3500	DCP17129
447150-3510	DCP17026
447150-3520	DCP17144
447150-3530	DCP17153
447150-3540	DCP17132
447150-3550	DCP17131
447150-3570	DCP17064
447150-3580	DCP02016
447150-3590	DCP02034
447150-3600	DCP02034
447150-3610	DCP02007
447150-3620	DCP02042
447150-3630	DCP32052
447150-3640	DCP27001

DENSO	Short Code
447150-3650	DCP32045
447150-3660	DCP32021
447150-3680	DCP50250
447150-3700	DCP32061
447150-3702	DCP32061
447150-3740	DCP50310
447150-3750	DCP50312
447150-3770	DCP50319
447150-3780	DCP50308
447150-3810	DCP50309
447150-3930	DCP09032
447150-3940	DCP21015
447150-3941	DCP21015
447150-3950	DCP17050
447150-3960	DCP17053
447150-3970	DCP17045
447150-3980	DCP17130
447150-3990	DCP17139
447150-4000	DCP17062
447150-4010	DCP17138
447150-4020	DCP17063
447150-4040	DCP17143
447150-4130	DCP50311
447150-4133	DCP50311
447150-4200	DCP32060
447150-4280	DCP02097
447150-4290	DCP02105
447150-4300	DCP02102
447150-4320	DCP17165
447150-4330	DCP17166
447150-4340	DCP17167
447150-4350	DCP17168
447150-4360	DCP17156
447150-4364	DCP17156
447150-4380	DCP28017
447150-4390	DCP17182
447150-4470	DCP17112
447150-4490	DCP17152
447150-4530	DCP50313
447150-4540	DCP09032
447150-4550	DCP50241
447150-4560	DCP17120
447150-4570	DCP09032
447150-4670	DCP09032
447150-4670	DCP09034
447150-4720	DCP21016
447150-4730	DCP21017
447150-4740	DCP50313
447150-4880	DCP50101
447150-4940	DCP02104
447150-4980	DCP28018
447150-4990	DCP50309
447150-5030	DCP05033
447150-5040	DCP17067
447150-5050	DCP17068
447150-5060	DCP17055
447150-5070	DCP17063
447150-5100	DCP17133
447150-5110	DCP17071
447150-5120	DCP17146
447150-5140	DCP02015
447150-5190	DCP50314
447150-5200	DCP21022
447150-5220	DCP20121
447150-5340	DCP28012
447150-5380	DCP17025
447150-5390	DCP17067
447150-5400	DCP17059
447150-5420	DCP17070
447150-5430	DCP17107
447150-5440	DCP17109

DENSO	Short Code
447150-5460	DCP17073
447150-5470	DCP02030
447150-5480	DCP02109
447150-5580	DCP05084
447150-5590	DCP20122
447150-5600	DCP20120
447150-5610	DCP20121
447150-5620	DCP20122
447150-5630	DCP02097
447150-5650	DCP02105
447150-5690	DCP17171
447150-5700	DCP28018
447150-5710	DCP05114
447150-5720	DCP05105
447150-5780	DCP20120
447150-5790	DCP47009
447150-5890	DCP50312
447150-5900	DCP21016
447150-5900	DCP21023
447150-5910	DCP50302
447150-6030	DCP32060
447150-6090	DCP32070
447150-6100	DCP05036
447150-6110	DCP05080
447150-6130	DCP32071
447150-6140	DCP02095
447150-6220	DCP47010
447150-6240	DCP50313
447150-6280	DCP05098
447150-6290	DCP17102
447150-6310	DCP02103
447150-6320	DCP02099
447150-6340	DCP50311
447150-6490	DCP05097
447150-6520	DCP32073
447150-6540	DCP32077
447150-6580	DCP28019
447150-6640	DCP50312
447150-6650	DCP50313
447150-6810	DCP17112
447150-6860	DCP32074
447150-6950	DCP20121
447150-6960	DCP20123
447150-6970	DCP20122
447150-6990	DCP20120
447150-7000	DCP20121
447150-7010	DCP20123
447150-7020	DCP20122
447150-7040	DCP20120
447150-7070	DCP32075
447150-7340	DCP32060
447150-7360	DCP21024
447150-7450	DCP09062
447150-7460	DCP09063
447150-7470	DCP09064
447150-7480	DCP02106
447150-7490	DCP02106
447150-7570	DCP50318
447150-7590	DCP50317
447150-7670	DCP32076
447150-7680	DCP50313
447150-7760	DCP50314
447150-7950	DCP32060
447150-8060	DCP21022
447150-8100	DCP21021
447160-0070	DCP50088
447160-0260	DCP02006
447160-0320	DCP32001
447160-0340	DCP05016
447160-0350	DCP17035
447160-0610	DCP06029

DENSO	Short Code
447160-0710	DCP99800
447160-0720	DCP99801
447160-0790	DCP17036
447160-0860	DCP17113
447160-0870	DCP12003
447160-0930	DCP05076
447160-1110	DCP13010
447160-1120	DCP01015
447160-1210	DCP05077
447160-1230	DCP05081
447160-1620	DCP05082
447160-1640	DCP05093
447160-1680	DCP50092
447160-1730	DCP50093
447160-1820	DCP17501
447160-1870	DCP50125
447160-1872	DCP50125
447160-1880	DCP50125
447160-1950	DCP50126
447160-1970	DCP50092
447160-2020	DCP50093
447160-2130	DCP17508
447160-2160	DCP05039
447160-2170	DCP05040
447160-2360	DCP17157
447160-2368	DCP17157
447160-2510	DCP36004
447160-2620	DCP50131
447160-2630	DCP50132
447160-3020	DCP40018
447160-3030	DCP05095
447160-3035	DCP05095
447160-3090	DCP17125
447160-3240	DCP50125
447160-3250	DCP50125
447160-3270	DCP50126
447160-3400	DCP17140
447160-3410	DCP17176
447160-3420	DCP17148
447160-3480	DCP05078
447160-3750	DCP05088
447160-3760	DCP99530
447160-4050	DCP99520
447160-4100	DCP05096
447160-4280	DCP05104
447160-4290	DCP05095
447160-4300	DCP17035
447160-4310	DCP17036
447160-4340	DCP17140
447160-4360	DCP17154
447160-4364	DCP17154
447160-4490	DCP12012
447160-4550	DCP17181
447160-4660	DCP99023
447160-4870	DCP17186
447160-4890	DCP50315
447160-5170	DCP05017
447160-5180	DCP05018
447160-5190	DCP05019
447160-5210	DCP02004
447160-5310	DCP02101
447160-5780	DCP23034
447160-5790	DCP23035
447160-5930	DCP02098
447160-5970	DCP17185
447160-5980	DCP17178
447160-5990	DCP17169
447160-6000	DCP17177
447160-6010	DCP17155
447160-6012	DCP17155
447160-6020	DCP17179

DENSO	Short Code
447160-6080	DCP40017
447160-6310	DCP17024
447160-6490	DCP50092
447160-6491	DCP50092
447160-6550	DCP50093
447160-6770	DCP47011
447160-6771	DCP47011
447160-6880	DCP46020
447160-6890	DCP46020
447160-6920	DCP46021
447160-6930	DCP46022
447160-7070	DCP17151
447160-7180	DCP50092
447160-7240	DCP50125
447160-7250	DCP50125
447160-7570	DCP02110
447160-7610	DCP32006
447160-8120	DCP17023
447160-8130	DCP17125
447160-8140	DCP17K37
447160-8410	DCP46024
447160-8470	DCP02098
447160-8500	DCP23539
447160-8510	DCP23540
447160-8520	DCP23541
447160-8730	DCP05115
447160-8740	DCP05106
447160-9770	DCP05050
447160-9780	DCP05076
447160-9790	DCP05077
447170-0050	DCP09007
447170-0090	DCP17064
447170-0091	DCP17064
447170-0560	DCP09003
447170-0660	DCP23002
447170-0690	DCP09001
447170-0760	DCP36006
447170-2310	DCP23530
447170-2320	DCP17025
447170-2400	DCP99510
447170-2530	DCP99003
447170-2580	DCP99003
447170-2820	DCP05014
447170-2830	DCP05013
447170-2850	DCP05016
447170-2860	DCP50021
447170-2890	DCP50025
447170-2900	DCP23531
447170-3090	DCP06003
447170-3400	DCP50031
447170-3470	DCP99527
447170-3630	DCP11003
447170-3650	DCP50087
447170-3700	DCP50073
447170-3750	DCP05001
447170-3770	DCP05003
447170-3780	DCP05004
447170-3810	DCP05006
447170-3820	DCP05007
447170-3830	DCP05008
447170-3840	DCP05009
447170-3860	DCP05010
447170-3880	DCP05003
447170-3890	DCP05010
447170-3930	DCP05012
447170-3940	DCP47007
447170-4040	DCP40002
447170-4830	DCP20004
447170-4910	DCP17034
447170-4970	DCP06009
447170-5000	DCP17036

# A/C Components

## Cross Reference Chart - DENSO > Short Code

DENSO	Short Code
447170-5060	DCP14006
447170-5370	DCP05014
447170-5380	DCP99005
447170-5430	DCP12009
447170-5480	DCP99810
447170-5500	DCP01001
447170-5530	DCP51000
447170-5540	DCP05013
447170-5550	DCP25001
447170-5640	DCP14018
447170-5650	DCP24004
447170-5660	DCP24005
447170-5730	DCP17023
447170-5740	DCP17024
447170-5770	DCP05016
447170-5790	DCP50090
447170-5850	DCP51015
447170-5940	DCP05014
447170-5960	DCP05017
447170-6170	DCP27001
447170-6210	DCP50026
447170-6270	DCP06017
447170-6280	DCP06017
447170-6290	DCP02004
447170-6300	DCP01001
447170-6340	DCP02005
447170-6350	DCP02006
447170-6360	DCP32001
447170-6370	DCP02007
447170-6600	DCP50060
447170-6640	DCP45008
447170-6720	DCP99831
447170-6940	DCP17505
447170-6950	DCP50115
447170-7000	DCP17026
447170-7060	DCP17025
447170-7150	DCP17038
447170-7180	DCP17064
447170-7250	DCP47006
447170-7260	DCP47003
447170-7360	DCP06016
447170-7380	DCP50081
447170-7410	DCP50014
447170-7420	DCP28008
447170-7510	DCP50115
447170-7550	DCP20004
447170-7560	DCP20005
447170-7570	DCP14018
447170-7580	DCP02047
447170-7640	DCP17025
447170-7650	DCP50020
447170-7660	DCP50022
447170-7680	DCP17023
447170-7690	DCP05018
447170-7700	DCP05013
447170-7810	DCP06025
447170-7850	DCP45009
447170-7860	DCP17114
447170-7900	DCP02045
447170-7910	DCP02010
447170-7920	DCP02048
447170-7930	DCP02061
447170-7940	DCP02008
447170-7970	DCP23535
447170-8000	DCP17153
447170-8010	DCP45014
447170-8020	DCP45012
447170-8030	DCP45011
447170-8060	DCP17080
447170-8140	DCP50040
447170-8180	DCP05046

DENSO	Short Code
447170-8200	DCP05021
447170-8210	DCP05107
447170-8220	DCP05094
447170-8230	DCP14018
447170-8240	DCP24004
447170-8250	DCP24005
447170-8280	DCP14007
447170-8290	DCP14008
447170-8310	DCP14018
447170-8330	DCP17026
447170-8340	DCP17144
447170-8430	DCP05014
447170-8440	DCP05014
447170-8450	DCP05016
447170-8600	DCP12004
447170-8610	DCP12005
447170-8640	DCP20003
447170-8650	DCP20004
447170-8660	DCP20005
447170-8670	DCP47003
447170-8680	DCP32052
447170-8770	DCP17035
447170-8790	DCP17092
447170-8920	DCP20006
447170-8930	DCP99505
447170-8940	DCP50001
447170-8950	DCP09002
447170-8960	DCP09008
447170-9080	DCP02046
447170-9090	DCP02011
447170-9100	DCP99821
447170-9110	DCP17036
447170-9140	DCP17113
447170-9230	DCP05017
447170-9240	DCP05018
447170-9250	DCP05019
447170-9380	DCP02013
447170-9420	DCP20030
447170-9440	DCP50220
447170-9450	DCP50221
447170-9460	DCP50222
447170-9470	DCP50223
447170-9480	DCP06012
447170-9490	DCP99517
447170-9510	DCP50095
447170-9780	DCP17063
447170-9820	DCP99020
447170-9900	DCP17043
447170-9903	DCP17043
447170-9910	DCP17041
447180-2790	DCP15001
447180-2860	DCP17050
447180-2880	DCP17031
447180-2890	DCP47001
447180-2900	DCP99802
447180-3010	DCP17023
447180-3020	DCP17025
447180-3021	DCP17025
447180-3060	DCP17010
447180-3130	DCP05039
447180-3140	DCP05039
447180-3190	DCP11007
447180-3200	DCP27002
447180-3310	DCP32023
447180-3320	DCP47003
447180-3480	DCP99512
447180-3500	DCP11045
447180-3510	DCP11010
447180-3550	DCP17026
447180-3580	DCP17180
447180-3600	DCP32006

DENSO	Short Code
447180-3600	DCP32006K
447180-3750	DCP17085
447180-3760	DCP28010
447180-3870	DCP02055
447180-3900	DCP32006
447180-3900	DCP32006K
447180-3920	DCP06003
447180-3960	DCP06009
447180-3970	DCP99002
447180-3980	DCP99001
447180-3990	DCP06006
447180-4040	DCP17026
447180-4090	DCP50100
447180-4130	DCP17043
447180-4139	DCP17043
447180-4140	DCP17102
447180-4150	DCP17026
447180-4270	DCP02010
447180-4280	DCP02010
447180-4290	DCP02011
447180-4320	DCP11011
447180-4340	DCP32003
447180-4360	DCP17508
447180-4369	DCP17508
447180-4440	DCP17039
447180-4450	DCP17038
447180-4470	DCP17051
447180-4510	DCP50120
447180-4520	DCP50122
447180-4550	DCP02009
447180-4590	DCP06026
447180-4610	DCP50006
447180-4620	DCP06021
447180-4670	DCP40012
447180-4700	DCP17160
447180-4720	DCP02025
447180-4730	DCP02091
447180-4750	DCP17064
447180-4759	DCP17064
447180-4760	DCP05022
447180-4900	DCP12003
447180-4920	DCP50009
447180-4940	DCP06016
447180-4950	DCP06017
447180-4960	DCP06017
447180-5180	DCP99528
447180-5240	DCP17039
447180-5260	DCP50103
447180-5320	DCP50097
447180-5350	DCP02010
447180-5360	DCP02061
447180-5370	DCP02011
447180-5390	DCP50102
447180-5410	DCP50130
447180-5420	DCP50085
447180-5430	DCP50086
447180-5480	DCP99523
447180-5510	DCP17102
447180-5530	DCP32003
447180-5540	DCP50074
447180-5590	DCP05032
447180-5640	DCP50121
447180-5650	DCP17026
447180-5670	DCP36002
447180-5680	DCP17125
447180-5740	DCP49002
447180-5870	DCP17059
447180-5880	DCP17058
447180-5940	DCP50001
447180-5970	DCP50002
447180-5990	DCP50006

DENSO	Short Code
447180-6140	DCP50011
447180-6160	DCP50013
447180-6190	DCP50116
447180-6220	DCP17026
447180-6300	DCP50004
447180-6380	DCP99513
447180-6390	DCP32045
447180-6490	DCP23025
447180-6530	DCP05038
447180-6580	DCP02038
447180-6640	DCP17070
447180-6650	DCP17071
447180-6700	DCP02012
447180-6710	DCP02023
447180-6720	DCP02024
447180-6730	DCP02025
447180-6760	DCP05020
447180-6800	DCP17038
447180-6890	DCP06020
447180-6930	DCP06016
447180-7040	DCP17046
447180-7200	DCP50120
447180-7260	DCP05032
447180-7270	DCP47004
447180-7280	DCP32020
447180-7290	DCP32005
447180-7330	DCP17054
447180-7400	DCP51003
447180-7460	DCP11008
447180-7520	DCP06018
447180-7550	DCP05021
447180-7560	DCP05107
447180-7570	DCP05079
447180-7580	DCP05037
447180-7650	DCP17038
447180-7700	DCP02016
447180-7710	DCP02016
447180-7720	DCP02014
447180-7730	DCP02015
447180-7780	DCP50226
447180-7790	DCP50082
447180-7820	DCP50033
447180-7840	DCP50030
447180-7850	DCP50032
447180-7860	DCP02015
447180-7880	DCP50083
447180-7890	DCP50224
447180-7900	DCP50225
447180-7920	DCP11012
447180-8090	DCP02035
447180-8100	DCP09004
447180-8180	DCP99525
447180-8200	DCP99518
447180-8270	DCP99803
447180-8360	DCP14012
447180-8370	DCP14013
447180-8380	DCP14014
447180-8450	DCP02034
447180-8470	DCP02027
447180-8480	DCP02039
447180-8530	DCP51002
447180-8590	DCP32022
447180-8600	DCP32031
447180-8610	DCP32051
447180-8620	DCP32006
447180-8620	DCP32006K
447180-8640	DCP50123
447180-8660	DCP50005
447180-8670	DCP50005
447180-8750	DCP50007
447180-8770	DCP50006

DENSO	Short Code
447180-8780	DCP50006
447180-8840	DCP50004
447180-8900	DCP50080
447180-8930	DCP05045
447180-9090	DCP50012
447180-9110	DCP50013
447180-9140	DCP50003
447180-9150	DCP50002
447180-9220	DCP50011
447180-9260	DCP50010
447180-9310	DCP44010
447180-9420	DCP50114
447180-9430	DCP50122
447180-9490	DCP02028
447180-9500	DCP02038
447180-9520	DCP05021
447180-9540	DCP36002
447180-9550	DCP36003
447180-9590	DCP05026
447180-9660	DCP17133
447180-9690	DCP17059
447180-9710	DCP17038
447180-9720	DCP17053
447180-9730	DCP17045
447180-9739	DCP17045
447180-9790	DCP17054
447180-9800	DCP17067
447180-9890	DCP50010
447180-9900	DCP17115
447180-9910	DCP17087
447180-9920	DCP17128
447180-9940	DCP17068
447180-9950	DCP17102
447180-9960	DCP17146
447180-9970	DCP17062
447190-1640	DCP09061
447190-1650	DCP09060
447190-2040	DCP45006
447190-2080	DCP40015
447190-2110	DCP32021
447190-2130	DCP09017
447190-2140	DCP20022
447190-2150	DCP09016
447190-2170	DCP99800
447190-2180	DCP17058
447190-2190	DCP50093
447190-2380	DCP17073
447190-2470	DCP50092
447190-2560	DCP05031
447190-2570	DCP05042
447190-2610	DCP50041
447190-2630	DCP05052
447190-3050	DCP17055
447190-3060	DCP17063
447190-3100	DCP51003
447190-3320	DCP02015
447190-3370	DCP17067
447190-3380	DCP17103
447190-3390	DCP17068
447190-3400	DCP02043
447190-3410	DCP02033
447190-3420	DCP02036
447190-3430	DCP02033
447190-3500	DCP17056
447190-3520	DCP36003
447190-3523	DCP36003
447190-3600	DCP28010
447190-3630	DCP02034
447190-3640	DCP02034
447190-3650	DCP32045
447190-3660	DCP50124

DENSO	Short Code
447190-3670	DCP36007
447190-3678	DCP36007
447190-3710	DCP15001
447190-3770	DCP05032
447190-3780	DCP05045
447190-3820	DCP02035
447190-3830	DCP02037
447190-3840	DCP02038
447190-3930	DCP99020
447190-4020	DCP99832
447190-4250	DCP47002
447190-4310	DCP02005
447190-4320	DCP02007
447190-4350	DCP32052
447190-4360	DCP27001
447190-4450	DCP50087
447190-4540	DCP51003
447190-4600	DCP05013
447190-4650	DCP32045
447190-4680	DCP40003
447190-4690	DCP32021
447190-4830	DCP17059
447190-4840	DCP17062
447190-4849	DCP17146
447190-4850	DCP17058
447190-4900	DCP17086
447190-4910	DCP02016
447190-4920	DCP02034
447190-4930	DCP02038
447190-4960	DCP02034
447190-4990	DCP06027
447190-5020	DCP50248
447190-5030	DCP20023
447190-5040	DCP20021
447190-5040	DCP20021K
447190-5050	DCP06022
447190-5060	DCP06022
447190-5130	DCP99807
447190-5140	DCP17121
447190-5150	DCP17150
447190-5160	DCP17122
447190-5200	DCP50301
447190-5220	DCP50240
447190-5230	DCP17071
447190-5240	DCP17070
447190-5300	DCP51001
447190-5350	DCP45003
447190-5400	DCP99801
447190-5410	DCP99809
447190-5450	DCP50122
447190-5470	DCP99822
447190-5480	DCP51016
447190-5500	DCP17034
447190-5510	DCP17092
447190-5520	DCP17035
447190-5530	DCP17036
447190-5550	DCP20022
447190-5640	DCP51004
447190-5642	DCP51004
447190-5670	DCP02004
447190-5750	DCP50076
447190-5940	DCP50245
447190-5970	DCP99524
447190-5980	DCP02030
447190-6000	DCP50042
447190-6090	DCP50035
447190-6100	DCP50039
447190-6160	DCP17026
447190-6170	DCP36002
447190-6190	DCP36003
447190-6230	DCP47002

DENSO	Short Code
447190-6260	DCP05026
447190-6270	DCP99830
447190-6271	DCP99830
447190-6360	DCP02033
447190-6370	DCP02034
447190-6380	DCP02033
447190-6390	DCP02034
447190-6400	DCP02063
447190-6410	DCP02035
447190-6420	DCP02036
447190-6430	DCP02016
447190-6440	DCP02037
447190-6450	DCP02014
447190-6460	DCP02038
447190-6470	DCP02038
447190-6480	DCP02039
447190-6570	DCP17143
447190-6580	DCP17060
447190-6590	DCP36001
447190-6620	DCP49001
447190-6670	DCP02040
447190-6680	DCP02041
447190-6740	DCP17065
447190-6760	DCP17142
447190-6870	DCP05033
447190-6900	DCP02042
447190-6910	DCP02043
447190-6920	DCP02015
447190-6930	DCP02044
447190-6940	DCP50246
447190-7050	DCP45004
447190-7060	DCP45005
447190-7130	DCP50302
447190-7140	DCP50300
447190-7150	DCP50301
447190-7151	DCP50301
447190-7200	DCP45013
447190-7210	DCP05020
447190-7230	DCP14019
447190-7260	DCP51002
447190-7400	DCP99022
447190-7460	DCP99519
447190-7470	DCP32067
447190-7500	DCP40004
447190-7530	DCP05031
447190-7560	DCP32021
447190-7570	DCP32006
447190-7580	DCP32022
447190-7590	DCP32031
447190-7600	DCP32051
447190-7610	DCP32006
447190-7610	DCP32006K
447190-7620	DCP32020
447190-7630	DCP32005
447190-7690	DCP17070
447190-7700	DCP17071
447190-7720	DCP17041
447190-7740	DCP17160
447190-7750	DCP17039
447190-7760	DCP05020
447190-7780	DCP02045
447190-7790	DCP02046
447190-7800	DCP50306
447190-7802	DCP50306
447190-7810	DCP17023
447190-7820	DCP17024
447190-7830	DCP02047
447190-7850	DCP02014
447190-7880	DCP05034
447190-7890	DCP05102
447190-7900	DCP50306

DENSO	Short Code
447190-7920	DCP05060
447190-7950	DCP32045
447190-7970	DCP05108
447190-8030	DCP17K37
447190-8040	DCP50249
447190-8050	DCP02048
447190-8060	DCP02016
447190-8070	DCP05035
447190-8090	DCP50243
447190-8092	DCP50243
447190-8110	DCP21021
447190-8120	DCP21014
447190-8210	DCP05083
447190-8230	DCP17072
447190-8250	DCP17125
447190-8270	DCP05094
447190-8280	DCP17026
447190-8290	DCP17043
447190-8300	DCP17085
447190-8310	DCP17039
447190-8320	DCP17102
447190-8330	DCP17026
447190-8360	DCP17026
447190-8370	DCP17064
447190-8420	DCP17063
447190-8440	DCP17135
447190-8460	DCP05050
447190-8470	DCP05061
447190-8520	DCP05084
447190-8540	DCP05036
447190-8600	DCP50228
447190-8610	DCP99017
447190-8630	DCP17026
447190-8640	DCP17144
447190-8650	DCP17153
447190-8670	DCP17064
447190-8680	DCP02008
447190-8690	DCP02055
447190-8700	DCP27002
447190-8710	DCP32002
447190-8720	DCP32003
447190-8890	DCP32020
447190-8900	DCP32005
447190-8950	DCP32021
447190-8990	DCP02015
447190-9050	DCP23537
447190-9080	DCP32022
447190-9170	DCP50248
447190-9180	DCP50240
447190-9192	DCP50246
447190-9200	DCP02050
447190-9280	DCP17073
447190-9340	DCP05037
447190-9360	DCP17025
447190-9370	DCP17050
447190-9380	DCP17080
447190-9390	DCP17102
447190-9440	DCP05014
447190-9450	DCP05015
447190-9500	DCP05052
447190-9520	DCP05038
447190-9550	DCP32023
447190-9560	DCP02013
447190-9570	DCP02028
447190-9580	DCP02009
447190-9590	DCP02091
447190-9610	DCP02015
447190-9620	DCP28008
447190-9650	DCP05021
447190-9670	DCP17101
447190-9680	DCP17100

# A/C Components

## Cross Reference Chart - DENSO > Short Code

DENSO	Short Code
447190-9690	DCP17104
447190-9700	DCP09020
447190-9730	DCP02052
447190-9740	DCP02052
447190-9750	DCP02052
447190-9780	DCP50241
447190-9950	DCP05062
447200-0010	DCP17031
447200-0010	DCP17033
447200-0010	DCP17034
447200-0010	DCP17084
447200-0010	DCP17092
447200-0010	DCP17505
447200-0020	DCP17012
447200-0020	DCP17013
447200-0090	DCP23538
447200-0090	DCP99504
447200-0090	DCP99505
447200-0100	DCP28004
447200-0200	DCP17095
447200-0240	DCP99810
447200-0240	DCP99820
447200-0246	DCP99810
447200-0530	DCP45010
447200-0680	DCP99502
447200-0800	DCP50050
447200-0980	DCP50071
447200-1200	DCP50023
447200-1210	DCP50024
447200-1210	DCP50025
447200-1440	DCP23530
447200-1590	DCP50021
447200-1600	DCP23531
447200-1630	DCP50031
447200-1710	DCP50073
447200-2200	DCP23535
447200-2230	DCP99505
447200-2290	DCP17505
447200-2300	DCP99505
447200-2300	DCP99512
447200-2480	DCP99513
447200-2690	DCP23537
447200-3000	DCP17010
447200-3010	DCP17011
447200-3030	DCP99002
447200-3070	DCP05001
447200-3070	DCP05008
447200-3080	DCP99510
447200-3080	DCP99530
447200-3090	DCP06001
447200-3200	DCP05003
447200-3210	DCP05004
447200-3210	DCP05009
447200-3310	DCP05006
447200-3340	DCP99001
447200-3380	DCP05003
447200-3390	DCP05010
447200-3400	DCP05007
447200-3420	DCP14001
447200-3420	DCP14003
447200-3430	DCP14002
447200-3470	DCP99003
447200-3660	DCP99521
447200-3660	DCP99522
447200-3720	DCP50078
447200-3726	DCP50078
447200-3740	DCP06002
447200-3920	DCP05012
447200-4140	DCP11001
447200-4150	DCP99004
447200-4180	DCP06003

DENSO	Short Code
447200-4200	DCP06006
447200-4210	DCP06006
447200-4500	DCP11002
447200-4540	DCP17019
447200-4540	DCP17020
447200-4550	DCP50078
447200-4660	DCP05010
447200-4680	DCP06009
447200-4800	DCP14004
447200-4810	DCP14005
447200-4820	DCP12004
447200-4820	DCP12005
447200-4820	DCP12008
447200-4930	DCP99510
447200-4930	DCP99511
447200-4930	DCP99530
447200-4960	DCP14006
447200-5030	DCP99510
447200-5130	DCP99003
447200-5140	DCP99003
447200-5240	DCP06003
447200-5350	DCP99002
447200-5360	DCP99001
447200-5400	DCP50074
447200-5420	DCP11003
447200-5420	DCP11007
447200-5520	DCP06009
447200-5620	DCP99005
447200-5660	DCP06005
447200-5670	DCP06006
447200-5700	DCP06003
447200-5750	DCP12009
447200-5960	DCP99517
447200-6000	DCP17005
447200-6000	DCP17006
447200-6000	DCP17008
447200-6010	DCP17007
447200-6010	DCP17008
447200-6010	DCP17015
447200-6010	DCP17147
447200-6050	DCP28006
447200-6270	DCP17017
447200-6270	DCP17147
447200-6540	DCP50087
447200-6544	DCP50087
447200-6860	DCP50087
447200-7050	DCP50099
447200-7070	DCP47008
447200-8580	DCP99B03
447200-9030	DCP24001
447200-9050	DCP17014
447200-9070	DCP20001
447200-9150	DCP13001
447200-9500	DCP05017
447200-9570	DCP02005
447200-9610	DCP28008
447200-9620	DCP17023
447200-9620	DCP17036
447200-9630	DCP02006
447200-9630	DCP32001
447200-9680	DCP02004
447200-9690	DCP17023
447200-9700	DCP20006
447200-9720	DCP25001
447200-9750	DCP05017
447200-9750	DCP05018
447200-9760	DCP17025
447200-9790	DCP05013
447200-9790	DCP05014
447200-9800	DCP05016
447200-9960	DCP02063

DENSO	Short Code
447200-9990	DCP02005
447220-0180	DCP17021
447220-1450	DCP50100
447220-3170	DCP51000
447220-3240	DCP50090
447220-3320	DCP05046
447220-3390	DCP47003
447220-3430	DCP50026
447220-3450	DCP06017
447220-3460	DCP06017
447220-3610	DCP50060
447220-3630	DCP45011
447220-3650	DCP45009
447220-3656	DCP45008
447220-3840	DCP99800
447220-3840	DCP99802
447220-3840	DCP99803
447220-3840	DCP99807
447220-3850	DCP47001
447220-3850	DCP47006
447220-3853	DCP47006
447220-3870	DCP06016
447220-3890	DCP50081
447220-3910	DCP50020
447220-3920	DCP50022
447220-3930	DCP50033
447220-3950	DCP50030
447220-3970	DCP06025
447220-3975	DCP06025
447220-3990	DCP45009
447220-3994	DCP45009
447220-4000	DCP17114
447220-4020	DCP45014
447220-4030	DCP45012
447220-4050	DCP99821
447220-4050	DCP99822
447220-4060	DCP50040
447220-4060	DCP50041
447220-4080	DCP14007
447220-4080	DCP14008
447220-4140	DCP47003
447220-4190	DCP50226
447220-4193	DCP50226
447220-4200	DCP50220
447220-4210	DCP50221
447220-4210	DCP50224
447220-4220	DCP50222
447220-4220	DCP50225
447220-4230	DCP50083
447220-4230	DCP50223
447220-4240	DCP50095
447220-4242	DCP50095
447220-4280	DCP06012
447220-4300	DCP50032
447220-4360	DCP15001
447220-4366	DCP15001
447220-4390	DCP50082
447220-4410	DCP99020
447220-4416	DCP99020
447220-4570	DCP47003
447220-4620	DCP99518
447220-4820	DCP06026
447220-4824	DCP06026
447220-4840	DCP06021
447220-4860	DCP40012
447220-4980	DCP06016
447220-4985	DCP06016
447220-4990	DCP06017
447220-5000	DCP06017
447220-5130	DCP50103
447220-5190	DCP50097

DENSO	Short Code
447220-5192	DCP50097
447220-5260	DCP50130
447220-5270	DCP50085
447220-5280	DCP50086
447220-5560	DCP06027
447220-5565	DCP06027
447220-5600	DCP06020
447220-5605	DCP06020
447220-5630	DCP06016
447220-5800	DCP47004
447220-5870	DCP06018
447220-5900	DCP40003
447220-6060	DCP50115
447220-6060	DCP99831
447220-6240	DCP50014
447220-6250	DCP50115
447220-6360	DCP50011
447220-6360	DCP50013
447220-6360	DCP50015
447220-6380	DCP50012
447220-6530	DCP50005
447220-6540	DCP50004
447220-6540	DCP50005
447220-6590	DCP99524
447220-6660	DCP50006
447220-6900	DCP49002
447220-6940	DCP09005
447220-6960	DCP23002
447220-6970	DCP12001
447220-6990	DCP09007
447220-7180	DCP06003
447220-7200	DCP06009
447220-7210	DCP99001
447220-7210	DCP99002
447220-7220	DCP06006
447220-7270	DCP99521
447220-7270	DCP99522
447220-7290	DCP12003
447220-7410	DCP99523
447220-7570	DCP99525
447220-7700	DCP99022
447220-7920	DCP17501
447220-8000	DCP17064
447220-8001	DCP17064
447220-8010	DCP20003
447220-8020	DCP05013
447220-8020	DCP05014
447220-8020	DCP05039
447220-8020	DCP05040
447220-8030	DCP01001
447220-8040	DCP25001
447220-8050	DCP14018
447220-8050	DCP24004
447220-8060	DCP24005
447220-8080	DCP17023
447220-8080	DCP17080
447220-8090	DCP17024
447220-8090	DCP17035
447220-8090	DCP17036
447220-8090	DCP17508
447220-8090	DCP17B35
447220-8090	DCP17K37
447220-8110	DCP05016
447220-8120	DCP27001
447220-8130	DCP20004
447220-8140	DCP02004
447220-8140	DCP02047
447220-8150	DCP01001
447220-8170	DCP02005
447220-8180	DCP02006
447220-8180	DCP32001

DENSO	Short Code
447220-8190	DCP02007
447220-8220	DCP17026
447220-8220	DCP17144
447220-8220	DCP17153
447220-8250	DCP17063
447220-8260	DCP28008
447220-8280	DCP05019
447220-8310	DCP20004
447220-8320	DCP20005
447220-8330	DCP14018
447220-8350	DCP02005
447220-8350	DCP02006
447220-8350	DCP32001
447220-8360	DCP17025
447220-8390	DCP02045
447220-8400	DCP02010
447220-8410	DCP02048
447220-8420	DCP02010
447220-8420	DCP02061
447220-8430	DCP02008
447220-8460	DCP50001
447220-8470	DCP05021
447220-8480	DCP05107
447220-8490	DCP05094
447220-8500	DCP14018
447220-8500	DCP24004
447220-8510	DCP24005
447220-8530	DCP14018
447220-8570	DCP32052
447220-8590	DCP20003
447220-8600	DCP20004
447220-8610	DCP20005
447220-8630	DCP09002
447220-8640	DCP09008
447220-8670	DCP02046
447220-8680	DCP02011
447220-8700	DCP17113
447220-8700	DCP17125
447220-8700	DCP17B29
447220-8740	DCP20006
447220-8750	DCP05017
447220-8750	DCP05018
447220-8760	DCP05019
447220-8810	DCP02013
447220-8840	DCP17038
447220-8850	DCP17041
447220-8850	DCP17043
447220-8859	DCP17043
447220-8870	DCP17050
447220-8880	DCP17046
447220-8940	DCP27002
447220-8950	DCP20030
447220-8990	DCP50009
447220-8994	DCP50009
447220-9010	DCP32023
447220-9030	DCP11045
447220-9040	DCP11010
447220-9050	DCP17026
447220-9080	DCP17180
447220-9090	DCP32006
447220-9090	DCP32006K
447220-9100	DCP17085
447220-9110	DCP28010
447220-9120	DCP02055
447220-9130	DCP32006
447220-9130	DCP32006K
447220-9140	DCP17026
447220-9150	DCP17026
447220-9150	DCP17043
447220-9150	DCP17102
447220-9159	DCP17043

DENSO	Short Code
447220-9180	DCP11011
447220-9200	DCP32003
447220-9220	DCP17039
447220-9220	DCP17064
447220-9229	DCP17064
447220-9230	DCP17038
447220-9240	DCP50120
447220-9240	DCP50122
447220-9240	DCP50306
447220-9249	DCP50120
447220-9249	DCP50122
447220-9249	DCP50306
447220-9250	DCP17051
447220-9260	DCP02009
447220-9260	DCP02025
447220-9280	DCP02091
447220-9300	DCP17026
447220-9300	DCP17160
447220-9310	DCP05022
447220-9320	DCP17038
447220-9330	DCP17026
447220-9330	DCP17039
447220-9330	DCP17102
447220-9330	DCP17146
447220-9339	DCP17102
447220-9350	DCP32003
447220-9360	DCP05052
447220-9370	DCP05020
447220-9370	DCP05037
447220-9390	DCP50121
447220-9390	DCP50124
447220-9399	DCP50124
447220-9460	DCP50001
447220-9470	DCP32003
447220-9480	DCP23025
447220-9500	DCP05038
447220-9510	DCP05021
447220-9530	DCP02038
447220-9540	DCP17070
447220-9540	DCP17071
447220-9560	DCP02012
447220-9570	DCP02023
447220-9580	DCP02024
447220-9590	DCP02025
447220-9600	DCP02010
447220-9600	DCP02026
447220-9670	DCP05032
447220-9680	DCP17054
447220-9680	DCP45003
447220-9690	DCP32020
447220-9700	DCP32005
447220-9710	DCP51003
447220-9712	DCP51003
447220-9730	DCP50246
447220-9730	DCP50248
447220-9760	DCP05033
447220-9760	DCP05079
447220-9760	DCP05107
447220-9790	DCP17038
447220-9800	DCP02014
447220-9800	DCP02016
447220-9800	DCP02036
447220-9800	DCP02037
447220-9800	DCP02090
447220-9810	DCP02033
447220-9810	DCP02034
447220-9820	DCP02027
447220-9820	DCP02033
447220-9820	DCP02034
447220-9830	DCP02015
447220-9840	DCP02015

DENSO	Short Code
447220-9850	DCP11012
447220-9880	DCP02035
447220-9910	DCP50306
447220-9919	DCP50120
447220-9919	DCP50306
447220-9930	DCP14012
447220-9930	DCP14013
447220-9940	DCP14014
447220-9960	DCP02063
447220-9970	DCP02039
447250-0350	DCP50313
447250-0410	DCP50311
447250-0870	DCP32073
447250-0890	DCP32077
447250-1070	DCP20122
447250-1080	DCP20120
447250-1180	DCP17143
447250-1440	DCP32075
447250-1490	DCP46025
447250-1950	DCP20122
447250-1960	DCP20121
447250-1970	DCP20122
447250-2000	DCP20120
447250-2020	DCP21024
447250-2330	DCP09062
447250-2330	DCP09063
447250-2340	DCP09064
447250-2500	DCP50317
447250-2500	DCP50318
447250-2650	DCP32076
447250-2660	DCP50313
447250-2790	DCP32060
447250-3240	DCP20121
447250-3250	DCP20122
447250-3260	DCP20122
447250-3280	DCP20120
447260-0040	DCP11008
447260-0090	DCP51002
447260-0091	DCP51002
447260-0110	DCP32022
447260-0120	DCP32031
447260-0130	DCP32051
447260-0140	DCP32006
447260-0140	DCP32006K
447260-0150	DCP50123
447260-0160	DCP05045
447260-0170	DCP05026
447260-0190	DCP50114
447260-0190	DCP50122
447260-0200	DCP02028
447260-0200	DCP02034
447260-0200	DCP02038
447260-0200	DCP02043
447260-0200	DCP02065
447260-0210	DCP17059
447260-0210	DCP17133
447260-0220	DCP17045
447260-0220	DCP17053
447260-0220	DCP17067
447260-0229	DCP17045
447260-0230	DCP17038
447260-0260	DCP17103
447260-0270	DCP17067
447260-0270	DCP17068
447260-0270	DCP17105
447260-0290	DCP17068
447260-0300	DCP17102
447260-0340	DCP32021
447260-0350	DCP09017
447260-0360	DCP20021
447260-0360	DCP20021K

DENSO	Short Code
447260-0360	DCP20022
447260-0370	DCP09016
447260-0370	DCP09020
447260-0390	DCP17058
447260-0390	DCP17059
447260-0390	DCP17062
447260-0410	DCP17073
447260-0450	DCP05031
447260-0470	DCP32052
447260-0480	DCP17055
447260-0480	DCP17063
447260-0490	DCP51003
447260-0492	DCP51003
447260-0580	DCP02015
447260-0600	DCP17071
447260-0620	DCP17056
447260-0630	DCP28010
447260-0650	DCP17067
447260-0659	DCP17086
447260-0730	DCP51003
447260-0737	DCP51003
447260-0770	DCP27001
447260-0780	DCP05013
447260-0780	DCP05014
447260-0780	DCP05039
447260-0790	DCP02007
447260-0800	DCP32045
447260-0840	DCP32021
447260-0850	DCP17058
447260-0850	DCP17059
447260-0850	DCP17062
447260-0859	DCP17146
447260-0890	DCP20023
447260-0900	DCP06022
447260-0930	DCP17071
447260-0940	DCP17070
447260-0950	DCP50240
447260-0960	DCP05042
447260-0970	DCP51001
447260-1020	DCP50301
447260-1060	DCP50122
447260-1100	DCP51004
447260-1107	DCP51004
447260-1170	DCP50245
447260-1178	DCP50245
447260-1180	DCP06022
447260-1200	DCP50039
447260-1200	DCP50042
447260-1250	DCP50035
447260-1250	DCP50301
447260-1260	DCP17026
447260-1280	DCP05026
447260-1290	DCP51001
447260-1300	DCP17060
447260-1309	DCP17143
447260-1310	DCP02040
447260-1310	DCP02042
447260-1320	DCP02041
447260-1320	DCP02052
447260-1350	DCP17065
447260-1370	DCP17142
447260-1379	DCP17142
447260-1420	DCP02042
447260-1420	DCP32061
447260-1425	DCP32061
447260-1430	DCP02043
447260-1430	DCP02044
447260-1440	DCP02015
447260-1460	DCP51002
447260-1461	DCP51002
447260-1462	DCP51002



# A/C Components

## Cross Reference Chart - DENSO > Short Code

DENSO	Short Code
447260-1490	DCP50228
447260-1490	DCP50302
447260-1500	DCP50240
447260-1500	DCP50242
447260-1500	DCP50246
447260-1500	DCP50248
447260-1500	DCP50300
447260-1506	DCP50242
447260-1510	DCP20022
447260-1510	DCP20121
447260-1520	DCP14019
447260-1550	DCP17070
447260-1560	DCP17071
447260-1570	DCP05034
447260-1580	DCP50249
447260-1581	DCP50242
447260-1590	DCP32020
447260-1600	DCP32021
447260-1610	DCP32006
447260-1610	DCP32006K
447260-1620	DCP32022
447260-1630	DCP05060
447260-1660	DCP32006
447260-1670	DCP32031
447260-1680	DCP32051
447260-1686	DCP32051
447260-1690	DCP32005
447260-1700	DCP32045
447260-1710	DCP05108
447260-1740	DCP50121
447260-1740	DCP50124
447260-1760	DCP05035
447260-1770	DCP50243
447260-1772	DCP50243
447260-1780	DCP50240
447260-1800	DCP17125
447260-1810	DCP05083
447260-1820	DCP17063
447260-1830	DCP17135
447260-1850	DCP05050
447260-1860	DCP05061
447260-1870	DCP17115
447260-1880	DCP17087
447260-1880	DCP17128
447260-1910	DCP05036
447260-1920	DCP21021
447260-1930	DCP21014
447260-1950	DCP32020
447260-1960	DCP32005
447260-1970	DCP32021
447260-2020	DCP32022
447260-2030	DCP14014
447260-2030	DCP50001
447260-2030	DCP50009
447260-2090	DCP17073
447260-2090	DCP17084
447260-2100	DCP05037
447260-2140	DCP27002
447260-2150	DCP02005
447260-2160	DCP17101
447260-2160	DCP17112
447260-2170	DCP17100
447260-2170	DCP17104
447260-2180	DCP50241
447260-2200	DCP05062
447260-2250	DCP20121
447260-2260	DCP28012
447260-2260	DCP28016
447260-2263	DCP28016
447260-2270	DCP50120
447260-2270	DCP50306

DENSO	Short Code
447260-2280	DCP02050
447260-2290	DCP17152
447260-2295	DCP17152
447260-2300	DCP17058
447260-2300	DCP17059
447260-2310	DCP17055
447260-2310	DCP17129
447260-2320	DCP50243
447260-2330	DCP50240
447260-2330	DCP50242
447260-2330	DCP50246
447260-2330	DCP50248
447260-2330	DCP50249
447260-2330	DCP50300
447260-2330	DCP50305
447260-2334	DCP50248
447260-2334	DCP50305
447260-2370	DCP17070
447260-2380	DCP17071
447260-2400	DCP11045
447260-2420	DCP11011
447260-2450	DCP05032
447260-2460	DCP05045
447260-2470	DCP05052
447260-2480	DCP05020
447260-2480	DCP05094
447260-2482	DCP05094
447260-2490	DCP32003
447260-2510	DCP32023
447260-2520	DCP05021
447260-2530	DCP05038
447260-2540	DCP32003
447260-2550	DCP02061
447260-2560	DCP02048
447260-2570	DCP02004
447260-2570	DCP02047
447260-2580	DCP02010
447260-2590	DCP02045
447260-2600	DCP02046
447260-2610	DCP17144
447260-2610	DCP17153
447260-2620	DCP17041
447260-2640	DCP05021
447260-2640	DCP17026
447260-2650	DCP17039
447260-2650	DCP17072
447260-2661	DCP06022
447260-2671	DCP05093
447260-2671	DCP06022
447260-2770	DCP05076
447260-2780	DCP05080
447260-2790	DCP02043
447260-2790	DCP02092
447260-2800	DCP05079
447260-2810	DCP17107
447260-2820	DCP17130
447260-2840	DCP17139
447260-2845	DCP17139
447260-2870	DCP17062
447260-2870	DCP17138
447260-2876	DCP17138
447260-2880	DCP17063
447260-2890	DCP50101
447260-2930	DCP50036
447260-2930	DCP50037
447260-2932	DCP50036
447260-2940	DCP17106
447260-2950	DCP17060
447260-2950	DCP17132
447260-2970	DCP17131
447260-2970	DCP17143

DENSO	Short Code
447260-2976	DCP17143
447260-2980	DCP05077
447260-2990	DCP05081
447260-3020	DCP13010
447260-3030	DCP01015
447260-3040	DCP23030
447260-3040	DCP23031
447260-3050	DCP23032
447260-3060	DCP32063
447260-3070	DCP17120
447260-3090	DCP17157
447260-3092	DCP17157
447260-3100	DCP07010
447260-3130	DCP17026
447260-3130	DCP17146
447260-3140	DCP05020
447260-3150	DCP05079
447260-3160	DCP05092
447260-3170	DCP05082
447260-3180	DCP05021
447260-3190	DCP05052
447260-3200	DCP05084
447260-3202	DCP05092
447260-3210	DCP05082
447260-3210	DCP05102
447260-3220	DCP05093
447260-3240	DCP17085
447260-3260	DCP17026
447260-3260	DCP17102
447260-3280	DCP17039
447260-3280	DCP17102
447260-3290	DCP17K37
447260-3310	DCP50304
447260-3313	DCP50304
447260-3340	DCP13005
447260-3341	DCP13005
447260-3350	DCP50125
447260-3351	DCP50125
447260-3360	DCP50126
447260-3380	DCP50123
447260-3430	DCP05016
447260-3450	DCP17025
447260-3460	DCP02008
447260-3470	DCP02011
447260-3480	DCP02009
447260-3480	DCP02025
447260-3490	DCP05033
447260-3490	DCP05079
447260-3490	DCP05107
447260-3500	DCP02014
447260-3500	DCP02016
447260-3500	DCP02036
447260-3500	DCP02037
447260-3500	DCP02090
447260-3660	DCP36002
447260-3670	DCP05033
447260-3690	DCP02060
447260-3700	DCP28014
447260-3701	DCP28014
447260-3720	DCP17109
447260-3730	DCP32050
447260-3731	DCP32050
447260-3740	DCP32069
447260-3750	DCP32071
447260-3753	DCP32071
447260-3760	DCP32062
447260-3770	DCP17112
447260-3780	DCP02042
447260-3810	DCP05091
447260-3812	DCP05091
447260-3820	DCP05095

DENSO	Short Code
447260-3822	DCP05095
447260-3830	DCP21021
447260-3840	DCP21014
447260-3850	DCP02034
447260-3850	DCP02095
447260-3870	DCP07010
447260-3880	DCP14020
447260-3890	DCP02099
447260-3890	DCP02103
447260-3900	DCP17126
447260-3903	DCP17126
447260-3910	DCP17127
447260-3913	DCP17127
447260-3940	DCP50101
447260-3943	DCP50101
447260-3944	DCP50101
447260-3950	DCP50125
447260-3960	DCP50126
447260-3990	DCP17053
447260-4030	DCP17159
447260-4030	DCP17163
447260-4030	DCP17182
447260-4040	DCP17140
447260-4050	DCP17148
447260-4050	DCP17176
447260-4053	DCP17181
447260-4060	DCP05089
447260-4070	DCP05090
447260-4080	DCP05078
447260-4160	DCP17161
447260-4200	DCP50250
447260-4200	DCP50251
447260-4200	DCP50252
447260-4200	DCP50253
447260-4210	DCP32061
447260-4211	DCP32061
447260-4230	DCP05088
447260-4260	DCP32022
447260-4270	DCP32071
447260-4272	DCP32071
447260-4280	DCP32031
447260-4280	DCP32055
447260-4281	DCP32031
447260-4290	DCP32064
447260-4300	DCP02096
447260-4320	DCP02095
447260-4500	DCP32074
447260-4510	DCP32065
447260-4520	DCP32072
447260-4521	DCP32072
447260-4530	DCP05096
447260-4540	DCP05097
447260-4690	DCP05104
447260-4700	DCP05098
447260-4710	DCP05095
447260-4720	DCP05099
447260-4760	DCP02013
447260-4770	DCP02038
447260-4780	DCP02091
447260-4790	DCP02035
447260-4830	DCP32068
447260-4890	DCP32070
447260-4900	DCP32066
447260-4960	DCP17162
447260-5000	DCP36002
447260-5010	DCP36003
447260-5011	DCP36003
447260-5290	DCP36003
447260-5292	DCP36003
447260-5350	DCP99832
447260-5430	DCP47002

DENSO	Short Code
447260-5692	DCP47002
447260-5780	DCP99830
447260-5781	DCP99830
447260-5820	DCP49001
447260-5900	DCP99017
447260-5980	DCP17140
447260-5982	DCP17140
447260-5990	DCP17154
447260-5992	DCP17154
447260-6080	DCP40003
447260-6120	DCP99807
447260-6120	DCP99809
447260-6130	DCP17121
447260-6130	DCP17122
447260-6130	DCP17150
447260-6250	DCP50076
447260-6251	DCP50076
447260-6340	DCP40004
447260-6342	DCP40004
447260-6480	DCP45013
447260-6490	DCP45004
447260-6500	DCP45005
447260-6560	DCP32067
447260-6570	DCP99526
447260-6571	DCP99519
447260-6980	DCP40012
447260-7000	DCP09001
447260-7100	DCP50011
447260-7100	DCP50013
447260-7270	DCP50002
447260-7291	DCP50006
447260-7300	DCP50116
447260-7301	DCP50116
447260-7360	DCP50004
447260-7760	DCP09004
447260-7810	DCP50007
447260-7840	DCP50006
447260-7850	DCP50010
447260-7880	DCP50002
447260-7880	DCP50003
447260-7940	DCP36001
447260-7940	DCP36002
447260-7960	DCP50010
447260-8000	DCP40002
447260-8020	DCP50092
447260-8040	DCP50093
447260-8090	DCP50080
447260-8120	DCP50226
447260-8130	DCP50082
447260-8350	DCP45006
447260-8351	DCP45006
447260-8370	DCP40015
447260-8390	DCP99800
447260-8390	DCP99801
447260-8740	DCP36007
447260-8746	DCP36007
447260-9090	DCP02030
447260-9090	DCP02050
447260-9180	DCP99023
447260-9800	DCP02016
447280-0050	DCP50088
447280-0070	DCP45011
447280-0170	DCP06029
447280-0171	DCP06029
447280-0930	DCP36004
447280-1070	DCP50131
447280-1080	DCP50132
447280-1230	DCP40018
447280-1650	DCP99520
447280-1800	DCP12012
447280-1840	DCP17186

DENSO	Short Code
447280-2160	DCP17185
447280-2170	DCP40017
447280-2310	DCP50092
447280-2470	DCP50092
447280-2700	DCP23539
447280-2700	DCP23540
447280-2710	DCP23541
447280-3150	DCP49001
447280-3160	DCP99017
447280-6070	DCP17051
447280-6110	DCP17067
447280-6180	DCP17158
447280-6181	DCP17158
447280-6190	DCP17164
447280-6240	DCP17038
447280-6290	DCP50101
447280-6320	DCP17508
447280-6320	DCP17B35
447280-6390	DCP02026
447280-6460	DCP32056
447280-6461	DCP32056
447280-6520	DCP02101
447280-6570	DCP50310
447280-6580	DCP50311
447280-6580	DCP50312
447280-6581	DCP50311
447280-6590	DCP50319
447280-6600	DCP50308
447280-6600	DCP50309
447280-6640	DCP28017
447280-6690	DCP09032
447280-6850	DCP21015
447280-6851	DCP21015
447280-6860	DCP32060
447280-6900	DCP23034
447280-6910	DCP23035
447280-6940	DCP17181
447280-7010	DCP02097
447280-7020	DCP02102
447280-7020	DCP02105
447280-7030	DCP02098
447280-7080	DCP17155
447280-7080	DCP17169
447280-7080	DCP17178
447280-7090	DCP17177
447280-7090	DCP17179
447280-7120	DCP17165
447280-7130	DCP17166
447280-7140	DCP17167
447280-7150	DCP17168
447280-7190	DCP17156
447280-7360	DCP21016
447280-7720	DCP09032
447280-7720	DCP09034
447280-7930	DCP50313
447280-7980	DCP17151
447280-8260	DCP05115
447280-8270	DCP05114
447280-8280	DCP05106
447280-8290	DCP05105
447280-8340	DCP47009
447280-8360	DCP51002
447280-8410	DCP17171
447280-8580	DCP20122
447280-8590	DCP20120
447280-8610	DCP21017
447280-8620	DCP50302
447280-8770	DCP32060
447280-8790	DCP02106
447280-8800	DCP02097
447280-8820	DCP02098

DENSO	Short Code
447280-8840	DCP02102
447280-8950	DCP47010
447280-9080	DCP50101
447280-9120	DCP50125
447280-9250	DCP02104
447280-9260	DCP28018
447280-9280	DCP50314
447280-9290	DCP02110
447280-9380	DCP46020
447280-9390	DCP46020
447280-9400	DCP46022
447280-9460	DCP46021
447280-9470	DCP21022
447280-9610	DCP02106
447280-9720	DCP02109
447300-0010	DCP17006
447300-0020	DCP17007
447300-0030	DCP17008
447300-0040	DCP17005
447300-0040	DCP17010
447300-0120	DCP17011
447300-0120	DCP17015
447300-0130	DCP99001
447300-0140	DCP99002
447300-0160	DCP17033
447300-0170	DCP14007
447300-0190	DCP17012
447300-0200	DCP17013
447300-0240	DCP50024
447300-0300	DCP28004
447300-0320	DCP28006
447300-0350	DCP99510
447300-0350	DCP99525
447300-0380	DCP24001
447300-0390	DCP23530
447300-0390	DCP23531
447300-0390	DCP99505
447300-0390	DCP99512
447300-0410	DCP06001
447300-0410	DCP06002
447300-0450	DCP99521
447300-0450	DCP99530
447300-0460	DCP17014
447300-0480	DCP50087
447300-0570	DCP05003
447300-0610	DCP50099
447300-0620	DCP50099
447300-0870	DCP47008
447300-0910	DCP09012
447300-0920	DCP09006
447300-0920	DCP09014
447300-0920	DCP09015
447300-0970	DCP36006
447300-1080	DCP99504
447300-1120	DCP99001
447300-1130	DCP99002
447300-1170	DCP50071
447300-1200	DCP17095
447300-1270	DCP14001
447300-1280	DCP14002
447300-1320	DCP14003
447300-1370	DCP20001
447300-1440	DCP99820
447300-1450	DCP99003
447300-1450	DCP99004
447300-1810	DCP50078
447300-2040	DCP99522
447300-2070	DCP50050
447300-2080	DCP17147
447300-2130	DCP45010
447300-2680	DCP13001

DENSO	Short Code
447300-2700	DCP99502
447300-2860	DCP09010
447300-3580	DCP17034
447300-3580	DCP17C36
447300-3710	DCP11001
447300-3940	DCP09011
447300-3960	DCP06003
447300-3980	DCP06006
447300-4170	DCP17023
447300-4630	DCP17017
447300-4650	DCP17147
447300-4660	DCP09009
447300-4710	DCP05014
447300-4710	DCP05016
447300-4710	DCP05018
447300-4720	DCP05013
447300-4720	DCP05017
447300-4780	DCP17017
447300-4810	DCP20003
447300-4850	DCP23535
447300-4850	DCP23538
447300-4960	DCP17084
447300-4970	DCP02005
447300-4970	DCP32001
447300-5080	DCP99523
447300-5110	DCP06009
447300-5380	DCP11002
447300-5380	DCP11003
447300-5550	DCP17019
447300-5560	DCP17020
447300-5650	DCP50021
447300-5950	DCP50025
447300-6000	DCP28008
447300-6040	DCP02006
447300-6140	DCP02004
447300-6180	DCP20006
447300-6220	DCP12001
447300-6220	DCP23002
447300-6260	DCP14005
447300-6270	DCP14004
447300-6340	DCP12008
447300-6370	DCP99511
447300-6390	DCP25001
447300-6480	DCP17021
447300-6620	DCP50031
447300-6770	DCP99003
447300-6900	DCP09007
447300-7070	DCP17025
447300-7130	DCP06003
447300-7230	DCP50073
447300-7230	DCP50074
447300-7250	DCP17064
447300-7400	DCP05001
447300-7410	DCP05007
447300-7420	DCP05003
447300-7430	DCP05004
447300-7430	DCP05010
447300-7460	DCP05006
447300-7480	DCP05008
447300-7500	DCP05009
447300-7520	DCP05012
447300-7590	DCP50087
447300-7670	DCP05014
447300-7670	DCP05016
447300-7670	DCP05018
447300-7670	DCP05019
447300-7680	DCP05013
447300-7680	DCP05017
447300-7800	DCP06005
447300-7800	DCP06006
447300-7820	DCP17036

# A/C Components

Cross Reference Chart - DENSO > Short Code

DENSO	Short Code
447300-7820	DCP17113
447300-7830	DCP40002
447300-7831	DCP40002
447300-7870	DCP50026
447300-7880	DCP14006
447300-7930	DCP20004
447300-7940	DCP20005
447300-7970	DCP50090
447300-8020	DCP99005
447300-8070	DCP47001
447300-8090	DCP15001
447300-8100	DCP99020
447300-8101	DCP99020
447300-8120	DCP12009
447300-8140	DCP99810
447300-8170	DCP01001
447300-8180	DCP51000
447300-8230	DCP14018
447300-8240	DCP24004
447300-8250	DCP24005
447300-8310	DCP45009
447300-8440	DCP05014
447300-8510	DCP17024
447300-8550	DCP09001
447300-8590	DCP99831
447300-8600	DCP50020
447300-8600	DCP50060
447300-8671	DCP45008
447300-8780	DCP50014
447300-8820	DCP02007
447300-8820	DCP27001
447300-8820	DCP27002
447300-8930	DCP17505
447300-8960	DCP06017
447300-8970	DCP50115
447300-8980	DCP17026
447300-8980	DCP17063
447300-9000	DCP17025
447300-9070	DCP17144
447300-9080	DCP17038
447300-9080	DCP17180
447300-9090	DCP36005
447300-9100	DCP47006
447300-9130	DCP47003
447300-9130	DCP47004
447300-9140	DCP09005
447300-9190	DCP06016
447300-9190	DCP06018
447300-9250	DCP50023
447300-9270	DCP50081
447300-9270	DCP50095
447300-9270	DCP50220
447300-9270	DCP50221
447300-9271	DCP50095
447300-9440	DCP50022
447300-9470	DCP06017
447300-9470	DCP06018
447300-9490	DCP02047
447300-9500	DCP50040
447300-9550	DCP02012
447300-9550	DCP02025
447300-9550	DCP02045
447300-9550	DCP02046
447300-9550	DCP02048
447300-9550	DCP02091
447300-9550	DCP32003
447300-9590	DCP02010
447300-9590	DCP02011
447300-9590	DCP02024
447300-9590	DCP02026
447300-9590	DCP02061

DENSO	Short Code
447300-9600	DCP02008
447300-9600	DCP02013
447300-9600	DCP02023
477220-8330	DCP14018
50777-0500	DCP09012
50777-0600	DCP09015
50777-2000	DCP09010
50777-5000	DCP09007
50777-5200	DCP09001
51207-0000	DCP01001
51207-0100	DCP13001
51207-4800	DCP01001
51270-1020	DCP13001
53107-0000	DCP01004
54407-0000	DCP01004
54407-0900	DCP09009
54407-1000	DCP09006
54407-1400	DCP09011
57067-5200	DCP12001
57067-5210	DCP23002
59247-5600	DCP09005
59247-5700	DCP09001
59247-5900	DCP09005
59247-6000	DCP09001
59257-5000	DCP09007
5A007-5000	DCP09002
5A787-5000	DCP09004
5A787-5200	DCP09004
5A797-5600	DCP09003
5A797-5700	DCP09008
5D337-5000	DCP09017
5D337-5300	DCP20023
5E5275600	DCP20023
BWK486	DCP05090
DCP21012	DCP21021

Short Code	DENSO
DCP50503	042000-0190
DCP51005	042200-0070
DCP51005	042200-0110
DCP51008	042200-0120
DCP50502	042200-0210
DCP51007	042200-0220
DCP51006	042200-0250
DCP51010	042200-0390
DCP51011	042200-0400
DCP50501	042200-0410
DCP50502	042200-0420
DCP51012	042200-0460
DCP50504	042200-0510
DCP50502	042200-1030
DCP50504	042200-1040
DCP50504	042200-1350
DCP17002	047100-8240
DCP99515	047100-8530
DCP17013	047100-8960
DCP17001	047100-8970
DCP28001	047100-9750
DCP17002	047200-2920
DCP99515	047200-3170
DCP17001	047200-3570
DCP17012	047200-3570
DCP28001	047200-4160
DCP17003	047200-6470
DCP02001	047200-6600
DCP02002	047200-7620
DCP02003	047200-8490
DCP17010	047200-8540
DCP28003	047200-9750
DCP17007	047300-0120
DCP17002	047300-2640
DCP99515	047300-2730
DCP17001	047300-3000
DCP28001	047300-3240
DCP17001	047300-3650
DCP17003	047300-3880
DCP02002	047300-3890
DCP02001	047300-4680
DCP02003	047300-4920
DCP17012	047300-5310
DCP28003	047300-5650
DCP99C00	047300-6160
DCP17012	047300-7140
DCP17013	047300-7150
DCP17011	047300-8470
DCP17010	047300-9640
DCP17033	147100-0350
DCP17001	147100-0750
DCP17003	147100-1430
DCP02001	147100-1600
DCP02002	147100-2890
DCP17033	147100-3570
DCP02003	147100-3900
DCP17010	147100-3960
DCP17011	147100-3970
DCP17012	147100-4760
DCP17012	147100-5020
DCP28003	147100-5430
DCP05012	147100-5690
DCP17012	147100-7510
DCP17013	147100-7520
DCP50070	147100-8500
DCP05003	147100-9980
DCP17011	147200-1240
DCP17012	147200-1380
DCP17013	147200-1380
DCP17007	147200-3330
DCP50070	147200-5630

Short Code	DENSO
DCP17001	147200-7180
DCP17002	147200-7190
DCP17003	147200-7200
DCP50070	147300-0170
DCP02003	147300-0360
DCP17006	247100-3010
DCP17007	247100-3020
DCP02003	247100-4080
DCP17001	247100-5910
DCP17002	247100-5920
DCP17003	247100-5930
DCP45012	247300-0030
DCP45014	247300-0030
DCP45011	247300-0040
DCP17080	247300-0050
DCP50015	247300-0090
DCP05046	247300-0130
DCP14007	247300-0170
DCP14008	247300-0180
DCP06025	247300-0220
DCP12004	247300-0340
DCP12005	247300-0350
DCP40015	247300-0360
DCP17035	247300-0380
DCP17035	247300-0381
DCP17114	247300-0400
DCP23025	247300-0470
DCP99821	247300-0510
DCP50006	247300-0600
DCP50115	247300-0600
DCP09008	247300-0620
DCP09002	247300-0630
DCP50222	247300-0700
DCP50223	247300-0700
DCP20030	247300-0710
DCP06012	247300-0730
DCP50013	247300-0780
DCP17031	247300-0900
DCP17501	247300-0900
DCP99800	247300-0920
DCP99802	247300-0920
DCP05039	247300-0990
DCP05039	247300-1000
DCP05040	247300-1000
DCP11007	247300-1060
DCP50100	247300-1190
DCP09003	247300-1220
DCP40012	247300-1330
DCP05022	247300-1430
DCP17125	247300-1510
DCP17508	247300-1510
DCP50033	247300-1560
DCP50041	247300-1560
DCP99832	247300-1600
DCP99528	247300-1630
DCP50011	247300-1660
DCP06021	247300-1670
DCP06026	247300-1800
DCP12003	247300-1880
DCP50097	247300-1940
DCP50076	247300-1950
DCP50080	247300-1950
DCP50082	247300-1950
DCP50085	247300-1950
DCP50130	247300-1950
DCP50224	247300-1950
DCP50086	247300-1960
DCP50103	247300-1980
DCP50116	247300-2030
DCP50002	247300-2040
DCP50006	247300-2160

Short Code	DENSO
DCP50013	247300-2190
DCP50004	247300-2210
DCP49002	247300-2240
DCP17092	247300-2370
DCP50226	247300-2670
DCP50032	247300-2700
DCP50030	247300-2710
DCP50083	247300-2720
DCP50225	247300-2720
DCP45004	247300-2760
DCP45005	247300-2760
DCP99518	247300-2780
DCP17100	247300-2790
DCP99803	247300-2800
DCP99807	247300-2800
DCP99800	247300-2810
DCP51002	247300-2890
DCP50116	247300-2910
DCP50007	247300-3030
DCP50006	247300-3040
DCP50004	247300-3070
DCP50003	247300-3080
DCP99524	247300-3080
DCP50011	247300-3090
DCP50012	247300-3090
DCP50002	247300-3100
DCP50013	247300-3140
DCP09003	247300-3170
DCP36003	247300-3190
DCP36002	247300-3200
DCP36003	247300-3210
DCP09008	247300-3230
DCP09002	247300-3240
DCP09004	247300-3270
DCP50005	247300-3330
DCP06020	247300-3350
DCP06020	247300-3352
DCP50010	247300-3410
DCP45006	247300-3640
DCP45013	247300-3640
DCP05031	247300-3720
DCP50092	247300-3740
DCP50092	247300-3741
DCP50093	247300-3830
DCP36007	247300-4210
DCP36007	247300-4211
DCP47002	247300-4220
DCP40003	247300-4370
DCP47002	247300-4460
DCP06027	247300-4480
DCP17121	247300-4510
DCP17150	247300-4520
DCP17122	247300-4530
DCP99801	247300-4600
DCP99809	247300-4610
DCP17034	247300-4650
DCP17036	247300-4660
DCP17C36	247300-4660
DCP17092	247300-4670
DCP17035	247300-4680
DCP99822	247300-4690
DCP06027	247300-4710
DCP36001	247300-4860
DCP36002	247300-4860
DCP99830	247300-4980
DCP49001	247300-5030
DCP49001	247300-5031
DCP99017	247300-5040
DCP51002	247300-5100
DCP99022	247300-5140

Short Code	DENSO
DCP32067	247300-5170
DCP99519	247300-5180
DCP05034	247300-5200
DCP05082	247300-5200
DCP05102	247300-5210
DCP05083	247300-5230
DCP05088	247300-5230
DCP05093	247300-5230
DCP05108	247300-5240
DCP05050	247300-5250
DCP40004	247300-5270
DCP17K37	247300-5360
DCP23530	247300-5510
DCP23531	247300-5510
DCP23537	247300-5510
DCP99505	247300-5510
DCP99513	247300-5510
DCP50088	247300-5670
DCP06029	247300-5820
DCP06029	247300-5821
DCP99801	247300-6090
DCP99800	247300-6100
DCP05076	247300-6130
DCP40018	247300-6210
DCP09003	247300-6220
DCP99517	247300-6240
DCP01015	247300-6250
DCP09008	247300-6250
DCP13010	247300-6260
DCP05077	247300-6270
DCP05081	247300-6290
DCP05022	247300-6320
DCP50092	247300-6490
DCP50092	247300-6491
DCP50093	247300-6540
DCP11008	247300-6700
DCP09002	247300-6730
DCP09007	247300-6740
DCP09005	247300-6750
DCP09001	247300-6760
DCP50092	247300-6800
DCP50093	247300-6850
DCP05125	247300-6870
DCP05125	247300-6871
DCP05126	247300-6890
DCP36004	247300-7140
DCP17157	247300-7170
DCP05131	247300-7310
DCP05132	247300-7310
DCP05095	247300-7420
DCP05096	247300-7420
DCP05125	247300-7570
DCP17140	247300-7650
DCP17148	247300-7650
DCP17176	247300-7660
DCP05078	247300-7690
DCP99520	247300-7840
DCP09060	247300-7920
DCP09061	247300-7930
DCP17140	247300-7970
DCP17154	247300-7970
DCP05095	247300-8070
DCP05096	247300-8070
DCP05104	247300-8070
DCP05106	247300-8070
DCP05115	247300-8070
DCP05078	247300-8120
DCP17186	247300-8130
DCP17185	247300-8140
DCP17181	247300-8200
DCP12012	247300-8220

# A/C Components

## Cross Reference Chart - Short Code > DENSO

Short Code	DENSO
DCP45009	247300-8310
DCP99023	247300-8360
DCP02098	247300-8390
DCP02101	247300-8390
DCP40017	247300-8690
DCP23034	247300-8990
DCP23035	247300-9000
DCP17178	247300-9240
DCP17169	247300-9250
DCP17177	247300-9260
DCP17155	247300-9270
DCP17179	247300-9280
DCP46020	247300-9700
DCP46021	247300-9720
DCP46020	247300-9730
DCP46022	247300-9740
DCP17151	247300-9900
DCP23539	247400-0530
DCP23541	247400-0530
DCP23540	247400-0540
DCP02098	247400-1290
DCP02101	247400-1290
DCP02110	247400-1290
DCP99526	247400-1390
DCP02110	247400-1490
DCP17153	248300-0010
DCP17026	248300-0020
DCP05021	248300-0040
DCP05094	248300-0050
DCP05107	248300-0060
DCP32031	248300-0070
DCP32052	248300-0070
DCP32055	248300-0070
DCP32031	248300-0071
DCP50001	248300-0080
DCP50009	248300-0080
DCP17050	248300-0110
DCP17043	248300-0120
DCP17085	248300-0120
DCP17041	248300-0130
DCP50121	248300-0140
DCP50121	248300-0143
DCP32023	248300-0150
DCP32051	248300-0150
DCP17026	248300-0160
DCP11011	248300-0170
DCP11045	248300-0170
DCP11010	248300-0180
DCP32006	248300-0210
DCP32006K	248300-0210
DCP28010	248300-0220
DCP17039	248300-0230
DCP17043	248300-0230
DCP17045	248300-0230
DCP17055	248300-0230
DCP17059	248300-0230
DCP17060	248300-0230
DCP17102	248300-0230
DCP17160	248300-0230
DCP17043	248300-0231
DCP17045	248300-0231
DCP17058	248300-0240
DCP17067	248300-0240
DCP17102	248300-0240
DCP17131	248300-0240
DCP17026	248300-0250
DCP17046	248300-0250
DCP17053	248300-0250
DCP17058	248300-0250
DCP17064	248300-0250
DCP17065	248300-0250

Short Code	DENSO
DCP17068	248300-0250
DCP17133	248300-0250
DCP17135	248300-0250
DCP17139	248300-0250
DCP17142	248300-0250
DCP17064	248300-0251
DCP17139	248300-0251
DCP17142	248300-0251
DCP02015	248300-0260
DCP02055	248300-0260
DCP02104	248300-0260
DCP32062	248300-0260
DCP32071	248300-0260
DCP32071	248300-0261
DCP32003	248300-0270
DCP17051	248300-0290
DCP02009	248300-0300
DCP32021	248300-0300
DCP05038	248300-0310
DCP50120	248300-0320
DCP50120	248300-0322
DCP32003	248300-0390
DCP05021	248300-0400
DCP05052	248300-0400
DCP05020	248300-0410
DCP32003	248300-0450
DCP32045	248300-0450
DCP05107	248300-0480
DCP02014	248300-0510
DCP02035	248300-0510
DCP02038	248300-0510
DCP02052	248300-0510
DCP17070	248300-0520
DCP50120	248300-0550
DCP51003	248300-0580
DCP17071	248300-0590
DCP05032	248300-0600
DCP05045	248300-0600
DCP05079	248300-0600
DCP32005	248300-0610
DCP32020	248300-0610
DCP17054	248300-0630
DCP50122	248300-0650
DCP50123	248300-0650
DCP50114	248300-0660
DCP50120	248300-0660
DCP50248	248300-0660
DCP05026	248300-0670
DCP05037	248300-0670
DCP02016	248300-0710
DCP02034	248300-0710
DCP02014	248300-0720
DCP17038	248300-0740
DCP17051	248300-0740
DCP17103	248300-0740
DCP17056	248300-0750
DCP14012	248300-0760
DCP14013	248300-0770
DCP14020	248300-0770
DCP14014	248300-0780
DCP14019	248300-0780
DCP02039	248300-0790
DCP02028	248300-0800
DCP17046	248300-0870
DCP17062	248300-0870
DCP17063	248300-0870
DCP17146	248300-0870
DCP17054	248300-0880
DCP32021	248300-0940
DCP09017	248300-0950
DCP13005	248300-0950

Short Code	DENSO
DCP09016	248300-0960
DCP09062	248300-0960
DCP05042	248300-0980
DCP05094	248300-0980
DCP05052	248300-0990
DCP05080	248300-0990
DCP05084	248300-0990
DCP32022	248300-1010
DCP02033	248300-1020
DCP02036	248300-1020
DCP50304	248300-1030
DCP50304	248300-1032
DCP11012	248300-1060
DCP05032	248300-1070
DCP05045	248300-1070
DCP02035	248300-1080
DCP02037	248300-1080
DCP02038	248300-1080
DCP02052	248300-1080
DCP05020	248300-1090
DCP50124	248300-1100
DCP17073	248300-1150
DCP32045	248300-1150
DCP17067	248300-1190
DCP17086	248300-1190
DCP17138	248300-1190
DCP06022	248300-1200
DCP17062	248300-1210
DCP17063	248300-1210
DCP17143	248300-1210
DCP17146	248300-1210
DCP20022	248300-1220
DCP05032	248300-1230
DCP05036	248300-1230
DCP05045	248300-1230
DCP02014	248300-1240
DCP02038	248300-1240
DCP50301	248300-1260
DCP51001	248300-1260
DCP05093	248300-1270
DCP06022	248300-1270
DCP50039	248300-1290
DCP50035	248300-1300
DCP50240	248300-1310
DCP50246	248300-1310
DCP5026	248300-1320
DCP45003	248300-1330
DCP50245	248300-1370
DCP50122	248300-1380
DCP50123	248300-1380
DCP50042	248300-1390
DCP51004	248300-1410
DCP51004	248300-1411
DCP50248	248300-1430
DCP50248	248300-1434
DCP50114	248300-1490
DCP50120	248300-1491
DCP50241	248300-1560
DCP50249	248300-1560
DCP17102	248300-1570
DCP50036	248300-1580
DCP50302	248300-1580
DCP50036	248300-1581
DCP50300	248300-1590
DCP02030	248300-1600
DCP02090	248300-1600
DCP02092	248300-1600
DCP02096	248300-1600
DCP02033	248300-1650
DCP02014	248300-1680
DCP02038	248300-1680

Short Code	DENSO
DCP02040	248300-1680
DCP02041	248300-1680
DCP02060	248300-1680
DCP02063	248300-1680
DCP02035	248300-1690
DCP02037	248300-1690
DCP02038	248300-1690
DCP02065	248300-1690
DCP32063	248300-1690
DCP02039	248300-1700
DCP02016	248300-1710
DCP02034	248300-1710
DCP02033	248300-1720
DCP02036	248300-1720
DCP02043	248300-1720
DCP32064	248300-1720
DCP05033	248300-1740
DCP50246	248300-1750
DCP05020	248300-1780
DCP05035	248300-1780
DCP05092	248300-1780
DCP02042	248300-1790
DCP02044	248300-1790
DCP02043	248300-1800
DCP17104	248300-1810
DCP17128	248300-1810
DCP17087	248300-1820
DCP17100	248300-1820
DCP17112	248300-1820
DCP17120	248300-1820
DCP17115	248300-1830
DCP20021	248300-1840
DCP20021K	248300-1840
DCP20122	248300-1840
DCP20022	248300-1850
DCP02016	248300-1860
DCP02027	248300-1860
DCP02028	248300-1860
DCP50306	248300-1870
DCP50306	248300-1871
DCP05060	248300-1890
DCP17073	248300-1900
DCP17084	248300-1900
DCP32045	248300-1900
DCP32005	248300-1910
DCP32020	248300-1910
DCP32021	248300-1920
DCP05061	248300-1930
DCP17072	248300-1980
DCP07010	248300-1990
DCP21014	248300-1990
DCP21021	248300-1990
DCP50243	248300-2000
DCP50037	248300-2020
DCP50228	248300-2020
DCP32022	248300-2060
DCP02050	248300-2070
DCP09020	248300-2110
DCP09032	248300-2110
DCP09063	248300-2110
DCP02052	248300-2120
DCP05062	248300-2130
DCP20023	248300-2140
DCP50242	248300-2170
DCP28012	248300-2180
DCP17105	248300-2190
DCP50240	248300-2220
DCP23030	248300-2230
DCP23031	248300-2240
DCP17171	248300-2260
DCP23032	248300-2260

Short Code	DENSO
DCP17058	248300-2380
DCP17107	248300-2380
DCP17129	248300-2380
DCP17130	248300-2380
DCP17132	248300-2380
DCP17055	248300-2390
DCP17059	248300-2390
DCP17060	248300-2390
DCP02092	248300-2400
DCP17143	248300-2430
DCP17131	248300-2440
DCP17070	248300-2450
DCP50101	248300-2490
DCP17132	248300-2500
DCP17060	248300-2510
DCP50305	248300-2550
DCP17152	248300-2560
DCP02042	248300-2570
DCP02052	248300-2580
DCP17071	248300-2600
DCP05080	248300-2620
DCP17106	248300-2630
DCP28014	248300-2650
DCP28017	248300-2650
DCP36002	248300-2660
DCP02042	248300-2680
DCP32071	248300-2680
DCP32071	248300-2682
DCP02095	248300-2690
DCP02034	248300-2700
DCP02103	248300-2700
DCP02105	248300-2700
DCP32050	248300-2730
DCP32070	248300-2730
DCP32072	248300-2730
DCP32073	248300-2730
DCP32050	248300-2732
DCP32072	248300-2732
DCP28016	248300-2750
DCP32065	248300-2770
DCP32066	248300-2770
DCP32069	248300-2770
DCP17104	248300-2780
DCP17128	248300-2780
DCP17087	248300-2790
DCP17112	248300-2790
DCP17120	248300-2790
DCP17165	248300-2790
DCP17101	248300-2800
DCP17115	248300-2800
DCP17112	248300-2810
DCP17126	248300-2810
DCP17161	248300-2810
DCP17162	248300-2810
DCP17126	248300-2812
DCP17127	248300-2820
DCP17156	248300-2820
DCP17159	248300-2820
DCP17166	248300-2820
DCP17127	248300-2822
DCP17156	248300-2822
DCP17073	248300-2850
DCP32045	248300-2850
DCP05091	248300-2880
DCP17109	248300-2940
DCP50101	248300-2950
DCP50312	248300-2950
DCP50313	248300-2950
DCP50101	248300-2951
DCP05089	248300-2960
DCP05098	248300-2990

Short Code	DENSO
DCP05099	248300-2990
DCP05105	248300-2990
DCP05097	248300-3000
DCP05114	248300-3000
DCP05090	248300-3010
DCP02095	248300-3020
DCP02097	248300-3020
DCP02099	248300-3020
DCP02102	248300-3020
DCP32061	248300-3020
DCP32061	248300-3021
DCP07010	248300-3040
DCP21014	248300-3040
DCP21021	248300-3040
DCP50252	248300-3050
DCP50251	248300-3060
DCP50318	248300-3060
DCP21015	248300-3080
DCP32068	248300-3100
DCP17158	248300-3110
DCP17164	248300-3110
DCP17167	248300-3110
DCP17168	248300-3110
DCP17158	248300-3111
DCP17163	248300-3120
DCP17182	248300-3120
DCP32060	248300-3140
DCP21017	248300-3160
DCP21021	248300-3160
DCP32056	248300-3180
DCP32056	248300-3181
DCP50250	248300-3200
DCP50308	248300-3200
DCP50319	248300-3200
DCP50253	248300-3210
DCP50309	248300-3210
DCP50317	248300-3210
DCP50101	248300-3230
DCP50310	248300-3230
DCP50312	248300-3230
DCP50313	248300-3230
DCP21016	248300-3260
DCP21022	248300-3260
DCP21024	248300-3260
DCP50311	248300-3270
DCP28018	248300-3370
DCP09032	248300-3380
DCP09034	248300-3380
DCP09064	248300-3380
DCP50314	248300-3410
DCP47009	248300-3490
DCP47010	248300-3490
DCP20122	248300-3500
DCP20121	248300-3510
DCP20120	248300-3520
DCP50311	248300-3570
DCP02106	248300-3670
DCP99807	437100-5010
DCP99800	437100-5020
DCP99801	437100-5030
DCP99809	437100-5040
DCP99505	437100-5050
DCP99504	437100-5060
DCP99522	437100-5070
DCP99517	437100-5080
DCP05001	437100-5090
DCP05003	437100-5100
DCP05004	437100-5110
DCP05006	437100-5120
DCP05007	437100-5130
DCP05008	437100-5140

Short Code	DENSO
DCP05009	437100-5150
DCP05010	437100-5160
DCP05012	437100-5170
DCP05022	437100-5180
DCP05026	437100-5190
DCP05061	437100-5200
DCP05062	437100-5210
DCP05014	437100-5220
DCP05016	437100-5230
DCP05018	437100-5240
DCP05019	437100-5250
DCP05039	437100-5260
DCP05017	437100-5270
DCP05060	437100-5280
DCP05042	437100-5290
DCP05094	437100-5300
DCP05038	437100-5310
DCP14012	437100-5340
DCP27002	437100-5350
DCP32020	437100-5360
DCP32005	437100-5370
DCP32056	437100-5380
DCP32052	437100-5390
DCP32023	437100-5400
DCP32003	437100-5410
DCP32031	437100-5420
DCP32006	437100-5430
DCP32022	437100-5440
DCP32051	437100-5450
DCP32021	437100-5460
DCP09016	437100-5470
DCP09020	437100-5480
DCP13001	437100-5490
DCP01001	437100-5500
DCP09005	437100-5510
DCP09007	437100-5520
DCP09009	437100-5540
DCP09006	437100-5550
DCP02023	437100-5570
DCP02008	437100-5580
DCP02012	437100-5590
DCP02061	437100-5600
DCP02024	437100-5610
DCP02007	437100-5620
DCP02039	437100-5630
DCP02028	437100-5640
DCP02092	437100-5660
DCP02063	437100-5670
DCP02065	437100-5680
DCP02030	437100-5690
DCP02060	437100-5710
DCP02004	437100-5720
DCP02006	437100-5730
DCP32001	437100-5740
DCP02005	437100-5750
DCP02047	437100-5760
DCP02026	437100-5770
DCP02091	437100-5780
DCP02025	437100-5790
DCP02009	437100-5800
DCP02015	437100-5810
DCP02027	437100-5820
DCP02034	437100-5830
DCP23530	437100-5840
DCP28008	437100-5850
DCP28012	437100-5860
DCP28016	437100-5870
DCP28010	437100-5880
DCP17021	437100-5890
DCP17033	437100-5900
DCP17505	437100-5910

Short Code	DENSO
DCP17031	437100-5920
DCP17084	437100-5930
DCP17034	437100-5940
DCP17092	437100-5950
DCP17012	437100-5960
DCP17013	437100-5970
DCP17095	437100-5980
DCP17501	437100-5990
DCP17010	437100-6000
DCP17011	437100-6010
DCP17019	437100-6020
DCP17020	437100-6030
DCP17006	437100-6040
DCP17005	437100-6050
DCP17008	437100-6060
DCP17007	437100-6070
DCP17015	437100-6080
DCP17017	437100-6090
DCP17114	437100-6100
DCP06012	437100-6110
DCP17121	437100-6120
DCP17122	437100-6130
DCP17140	437100-6140
DCP17025	437100-6150
DCP17087	437100-6160
DCP17100	437100-6170
DCP17067	437100-6180
DCP17068	437100-6190
DCP17105	437100-6200
DCP17071	437100-6210
DCP17107	437100-6220
DCP17112	437100-6230
DCP17103	437100-6240
DCP17115	437100-6250
DCP17101	437100-6260
DCP17104	437100-6270
DCP17128	437100-6280
DCP17023	437100-6290
DCP17080	437100-6300
DCP17125	437100-6310
DCP17036	437100-6320
DCP17113	437100-6330
DCP17144	437100-6340
DCP17085	437100-6360
DCP17026	437100-6370
DCP17038	437100-6380
DCP17039	437100-6390
DCP17109	437100-6400
DCP17102	437100-6410
DCP25001	437100-6430
DCP12008	437100-6440
DCP12005	437100-6450
DCP17051	437100-6590
DCP17046	437100-6600
DCP17050	437100-6610
DCP17143	437100-6620
DCP17135	437100-6630
DCP05091	437100-6640
DCP05050	437100-6650
DCP05036	437100-6660
DCP05084	437100-6670
DCP17146	437100-6680
DCP05080	437100-6690
DCP05092	437100-6700
DCP05035	437100-6710
DCP05089	437100-6720
DCP05090	437100-6730
DCP05106	437100-6740
DCP05077	437100-6750
DCP05104	437100-6760
DCP05082	437100-6770

Short Code	DENSO
DCP05034	437100-6780
DCP05093	437100-6790
DCP05083	437100-6800
DCP05088	437100-6810
DCP05078	437100-6820
DCP05098	437100-6830
DCP05105	437100-6840
DCP02016	437100-6850
DCP05079	437100-6860
DCP05032	437100-6870
DCP05045	437100-6880
DCP05052	437100-6890
DCP05020	437100-6900
DCP05076	437100-6910
DCP05037	437100-6920
DCP05021	437100-6930
DCP05033	437100-6940
DCP05031	437100-6950
DCP32045	437100-6960
DCP02041	437100-6970
DCP05081	437100-6980
DCP05096	437100-6990
DCP05097	437100-7000
DCP32060	437100-7010
DCP02090	437100-7020
DCP02014	437100-7030
DCP02038	437100-7040
DCP02040	437100-7050
DCP17133	437100-7060
DCP02035	437100-7070
DCP17130	437100-7080
DCP17058	437100-7090
DCP17059	437100-7100
DCP17062	437100-7110
DCP17126	437100-7120
DCP17127	437100-7130
DCP17060	437100-7140
DCP17132	437100-7150
DCP17131	437100-7160
DCP17138	437100-7170
DCP02037	437100-7180
DCP02052	437100-7190
DCP02036	437100-7200
DCP17043	437100-7210
DCP17045	437100-7220
DCP17070	437100-7230
DCP14014	437100-7240
DCP32050	437100-7250
DCP99510	437100-7260
DCP99525	437100-7260
DCP05108	437100-7270
DCP11010	437100-7280
DCP11012	437100-7290
DCP17152	437100-7300
DCP17156	437100-7310
DCP17153	437100-7320
DCP32063	437100-7330
DCP32069	437100-7340
DCP32071	437100-7350
DCP32062	437100-7360
DCP32061	437100-7370
DCP32067	437100-7380
DCP32068	437100-7390
DCP02095	437100-7400
DCP02043	437100-7410
DCP32066	437100-7420
DCP32065	437100-7430
DCP17148	437100-7440
DCP11011	437100-7450
DCP32070	437100-7470
DCP28017	437100-7480

Short Code	DENSO
DCP02096	437100-7490
DCP32064	437100-7500
DCP05107	437100-7510
DCP14019	437100-7520
DCP17151	437100-7530
DCP99521	437100-7540
DCP14018	437100-7550
DCP99523	437100-7560
DCP17147	437100-7570
DCP17150	437100-7580
DCP49002	437100-7600
DCP99524	437100-7610
DCP99017	437100-7620
DCP17001	437100-7630
DCP17003	437100-7640
DCP02001	437100-7650
DCP02003	437100-7660
DCP99515	437100-7670
DCP49001	437100-7740
DCP02033	437100-7780
DCP02042	437100-7790
DCP17014	437100-7800
DCP17106	437100-7810
DCP17120	437100-7820
DCP05013	437100-7830
DCP11007	437100-7840
DCP99511	437100-7850
DCP99513	437100-7860
DCP28014	437100-7870
DCP24005	437100-7880
DCP27001	437100-7890
DCP12012	437100-7940
DCP17035	437100-7950
DCP14013	437100-7960
DCP17K37	437100-7970
DCP02044	437100-7980
DCP17155	437100-7990
DCP20004	437100-8000
DCP02097	437100-8010
DCP02099	437100-8020
DCP02098	437100-8030
DCP17154	437100-8040
DCP32072	437100-8050
DCP17157	437100-8060
DCP20001	437100-8070
DCP99502	437100-8080
DCP17053	437100-8110
DCP17142	437100-8120
DCP17064	437100-8130
DCP17065	437100-8140
DCP17139	437100-8150
DCP17063	437100-8160
DCP17129	437100-8170
DCP17055	437100-8180
DCP05095	437100-8190
DCP05099	437100-8200
DCP02050	437100-8210
DCP17073	437100-8220
DCP06025	437100-8240
DCP99520	437100-8250
DCP02048	437100-8260
DCP02010	437100-8270
DCP02045	437100-8280
DCP02055	437100-8290
DCP02101	437100-8310
DCP02102	437100-8320
DCP17158	437100-8330
DCP21015	437100-8340
DCP17168	437100-8380
DCP02103	437100-8400
DCP02104	437100-8410

Short Code	DENSO
DCP17164	437100-8420
DCP17167	437100-8430
DCP17159	437100-8440
DCP17165	437100-8450
DCP17161	437100-8460
DCP17162	437100-8470
DCP17163	437100-8480
DCP02105	437100-8590
DCP17166	437100-8600
DCP17177	437100-8610
DCP17112	437100-8620
DCP17169	437100-8630
DCP17176	437100-8640
DCP06020	437100-8680
DCP24004	437100-8760
DCP17160	437100-8960
DCP28018	437100-8980
DCP20021	437100-8990
DCP20021K	437100-8990
DCP20022	437100-9000
DCP20023	437100-9010
DCP23034	437100-9020
DCP23035	437100-9030
DCP32073	437100-9080
DCP17185	437100-9090
DCP17178	437100-9100
DCP14020	437100-9110
DCP17179	437100-9130
DCP17180	437100-9140
DCP17181	437100-9150
DCP17182	437100-9160
DCP17186	437100-9180
DCP02106	437100-9860
DCP02107	437100-9890
DCP02108	437100-9900
DCP46024	437100-9960
DCP99530	437140-0010
DCP02110	437140-0030
DCP46025	437140-0060
DCP23539	437140-0080
DCP23540	437140-0090
DCP23541	437140-0100
DCP05115	437140-0130
DCP46020	437140-0140
DCP46021	437140-0150
DCP46022	437140-0160
DCP99527	437140-0170
DCP99528	437140-0180
DCP99812	437140-0190
DCP28019	437150-0010
DCP21023	437150-0080
DCP32074	437150-0110
DCP32075	437150-0120
DCP32076	437150-0130
DCP02109	437150-0140
DCP32077	437150-0150
DCP05114	437150-0160
DCP17171	437150-0170
DCP09007	442100-0120
DCP12001	442100-0240
DCP09005	442100-0280
DCP23002	442100-0290
DCP09001	442100-1020
DCP09003	442100-3160
DCP50013	442100-3200
DCP50015	442100-3200
DCP09060	442100-3370
DCP09004	442100-4000
DCP09061	442100-4030
DCP09006	442500-2130
DCP09011	442500-2130

Short Code	DENSO
DCP09009	442500-2150
DCP09010	442500-2210
DCP36006	442500-2810
DCP09012	442500-4210
DCP09015	442500-4230
DCP09014	442500-4250
DCP36005	442500-4600
DCP17C36	446300-7890
DCP09012	447100-0020
DCP09015	447100-0030
DCP09010	447100-0420
DCP09009	447100-0950
DCP09006	447100-0960
DCP09011	447100-1030
DCP09011	447100-1180
DCP12001	447100-1520
DCP09014	447100-1530
DCP09005	447100-1560
DCP36005	447100-1610
DCP09004	447100-1870
DCP50013	447100-1930
DCP50015	447100-1950
DCP17006	447100-2010
DCP17007	447100-2020
DCP17008	447100-2030
DCP17010	447100-2060
DCP17011	447100-2070
DCP99002	447100-2110
DCP17033	447100-2160
DCP17012	447100-2190
DCP17013	447100-2200
DCP05001	447100-2280
DCP99505	447100-2320
DCP28004	447100-2330
DCP28006	447100-2350
DCP99510	447100-2380
DCP24001	447100-2400
DCP06001	447100-2430
DCP17014	447100-2480
DCP99530	447100-2490
DCP05003	447100-2600
DCP05004	447100-2610
DCP17015	447100-2650
DCP50099	447100-2700
DCP47008	447100-2810
DCP05006	447100-2830
DCP99001	447100-2940
DCP99504	447100-2990
DCP17005	447100-3020
DCP99001	447100-3120
DCP99002	447100-3130
DCP05003	447100-3150
DCP05010	447100-3160
DCP05007	447100-3170
DCP17095	447100-3210
DCP14001	447100-3280
DCP14002	447100-3290
DCP14003	447100-3300
DCP20001	447100-3360
DCP99820	447100-3460
DCP99003	447100-3470
DCP99521	447100-3830
DCP06002	447100-4080
DCP99522	447100-4190
DCP17147	447100-4440
DCP17147	447100-4443
DCP45010	447100-4540
DCP13001	447100-4980
DCP99502	447100-5050
DCP05008	447100-5540
DCP05009	447100-5720

Short Code	DENSO
DCP50050	447100-5960
DCP17084	447100-6030
DCP11001	447100-6260
DCP99004	447100-6290
DCP17034	447100-6380
DCP06003	447100-6590
DCP06005	447100-6610
DCP06006	447100-6620
DCP17023	447100-6820
DCP50071	447100-7040
DCP05012	447100-7130
DCP17017	447100-7430
DCP17147	447100-7450
DCP05018	447100-7470
DCP05017	447100-7590
DCP05019	447100-7600
DCP17017	447100-7720
DCP20003	447100-7770
DCP23538	447100-7860
DCP02005	447100-7920
DCP06009	447100-8080
DCP50078	447100-8330
DCP11002	447100-8430
DCP99515	447100-8530
DCP17019	447100-8620
DCP17020	447100-8630
DCP50023	447100-8740
DCP50024	447100-8750
DCP05010	447100-9040
DCP28008	447100-9110
DCP17023	447100-9230
DCP02006	447100-9270
DCP02004	447100-9440
DCP32001	447100-9500
DCP20006	447100-9510
DCP14004	447100-9620
DCP14005	447100-9630
DCP12008	447100-9750
DCP99511	447100-9790
DCP25001	447100-9810
DCP17021	447100-9950
DCP02098	447140-0340
DCP02101	447140-0360
DCP02110	447140-0370
DCP05081	447140-0450
DCP05095	447140-0460
DCP47013	447140-0520
DCP02005	447140-0590
DCP99526	447140-0620
DCP02006	447140-0640
DCP05096	447140-1230
DCP47012	447140-1270
DCP05078	447140-1580
DCP46025	447140-1760
DCP23031	447150-0010
DCP23030	447150-0020
DCP23032	447150-0040
DCP28012	447150-0080
DCP17152	447150-0090
DCP17152	447150-0096
DCP02010	447150-0100
DCP02011	447150-0110
DCP02027	447150-0120
DCP05107	447150-0130
DCP05079	447150-0140
DCP05032	447150-0150
DCP05045	447150-0160
DCP17051	447150-0170
DCP17046	447150-0180
DCP17105	447150-0210
DCP07010	447150-0220

Short Code	DENSO
DCP17059	447150-0230
DCP17062	447150-0240
DCP17138	447150-0250
DCP17058	447150-0260
DCP17055	447150-0270
DCP17063	447150-0280
DCP17129	447150-0300
DCP50242	447150-0310
DCP50243	447150-0320
DCP50240	447150-0330
DCP50246	447150-0332
DCP50248	447150-0340
DCP50240	447150-0350
DCP17070	447150-0370
DCP17071	447150-0380
DCP05052	447150-0390
DCP17067	447150-0420
DCP17067	447150-0430
DCP17038	447150-0450
DCP17038	447150-0460
DCP17038	447150-0470
DCP17053	447150-0490
DCP17045	447150-0500
DCP17055	447150-0520
DCP17063	447150-0530
DCP02061	447150-0550
DCP02012	447150-0560
DCP02043	447150-0570
DCP02025	447150-0580
DCP02025	447150-0590
DCP02026	447150-0600
DCP06022	447150-0610
DCP06022	447150-0620
DCP05080	447150-0630
DCP02092	447150-0660
DCP05079	447150-0670
DCP17107	447150-0680
DCP17130	447150-0690
DCP17060	447150-0700
DCP17139	447150-0720
DCP17112	447150-0730
DCP50101	447150-0770
DCP02090	447150-0780
DCP50037	447150-0790
DCP50036	447150-0800
DCP50036	447150-0801
DCP17106	447150-0810
DCP17132	447150-0820
DCP17131	447150-0840
DCP17143	447150-0850
DCP32063	447150-0860
DCP17120	447150-0870
DCP17109	447150-0890
DCP17112	447150-0900
DCP02052	447150-0920
DCP02042	447150-0930
DCP17146	447150-0960
DCP05020	447150-0970
DCP05079	447150-0980
DCP05092	447150-0990
DCP17067	447150-1000
DCP17133	447150-1010
DCP17059	447150-1020
DCP50242	447150-1080
DCP50304	447150-1130
DCP50305	447150-1140
DCP13005	447150-1150
DCP02043	447150-1160
DCP02023	447150-1190
DCP02024	447150-1200
DCP02015	447150-1230

Short Code	DENSO
DCP17059	447150-1240
DCP17062	447150-1250
DCP17058	447150-1260
DCP11045	447150-1380
DCP11010	447150-1390
DCP36002	447150-1420
DCP05033	447150-1430
DCP02060	447150-1450
DCP28014	447150-1490
DCP32050	447150-1520
DCP32069	447150-1530
DCP32071	447150-1540
DCP32071	447150-1549
DCP32062	447150-1550
DCP02036	447150-1570
DCP02037	447150-1580
DCP02035	447150-1590
DCP02065	447150-1600
DCP28010	447150-1610
DCP02042	447150-1620
DCP28016	447150-1630
DCP50240	447150-1640
DCP05091	447150-1660
DCP17068	447150-1670
DCP17102	447150-1680
DCP02038	447150-1690
DCP02016	447150-1700
DCP02014	447150-1710
DCP02063	447150-1720
DCP21021	447150-1730
DCP21014	447150-1740
DCP07010	447150-1750
DCP02095	447150-1760
DCP02034	447150-1770
DCP14020	447150-1790
DCP17126	447150-1850
DCP17127	447150-1860
DCP50101	447150-1870
DCP50101	447150-1872
DCP02033	447150-1880
DCP02033	447150-1890
DCP02039	447150-1900
DCP02040	447150-1910
DCP02041	447150-1920
DCP02030	447150-1930
DCP17026	447150-1940
DCP17143	447150-1970
DCP17060	447150-1980
DCP17065	447150-1990
DCP17142	447150-2010
DCP17159	447150-2090
DCP05089	447150-2100
DCP17103	447150-2130
DCP17115	447150-2140
DCP17087	447150-2150
DCP17128	447150-2160
DCP17041	447150-2170
DCP17160	447150-2190
DCP17039	447150-2200
DCP17072	447150-2210
DCP32020	447150-2220
DCP32005	447150-2230
DCP05090	447150-2240
DCP17161	447150-2300
DCP50251	447150-2320
DCP02103	447150-2340
DCP02099	447150-2350
DCP32061	447150-2360
DCP32061	447150-2367
DCP28019	447150-2400
DCP32022	447150-2410

Short Code	DENSO
DCP32071	447150-2420
DCP32071	447150-2424
DCP32055	447150-2430
DCP32064	447150-2440
DCP02096	447150-2450
DCP50252	447150-2460
DCP32065	447150-2600
DCP32072	447150-2610
DCP32072	447150-2617
DCP05097	447150-2620
DCP05098	447150-2660
DCP05099	447150-2670
DCP17135	447150-2700
DCP17026	447150-2720
DCP17026	447150-2740
DCP17085	447150-2750
DCP17064	447150-2760
DCP17026	447150-2780
DCP17043	447150-2790
DCP17039	447150-2820
DCP17102	447150-2830
DCP05042	447150-2840
DCP02050	447150-2870
DCP32068	447150-2880
DCP32070	447150-2930
DCP32070	447150-2938
DCP32066	447150-2940
DCP17162	447150-2970
DCP17163	447150-2980
DCP17051	447150-3040
DCP17101	447150-3050
DCP17100	447150-3060
DCP17104	447150-3070
DCP17060	447150-3080
DCP17102	447150-3110
DCP50101	447150-3200
DCP21021	447150-3250
DCP17158	447150-3260
DCP17158	447150-3266
DCP17164	447150-3270
DCP50253	447150-3300
DCP02107	447150-3310
DCP02108	447150-3320
DCP50251	447150-3330
DCP50252	447150-3350
DCP50101	447150-3360
DCP50101	447150-3361
DCP32056	447150-3370
DCP17046	447150-3400
DCP17038	447150-3410
DCP17108	447150-3420
DCP17038	447150-3430
DCP17105	447150-3440
DCP17059	447150-3470
DCP17058	447150-3480
DCP17055	447150-3490
DCP17129	447150-3500
DCP17026	447150-3510
DCP17144	447150-3520
DCP17153	447150-3530
DCP17132	447150-3540
DCP17131	447150-3550
DCP17064	447150-3570
DCP02016	447150-3580
DCP02034	447150-3600
DCP02007	447150-3610
DCP02042	447150-3620
DCP32052	447150-3630
DCP27001	447150-3640



# A/C Components

## Cross Reference Chart - Short Code > DENSO

Short Code	DENSO
DCP32045	447150-3650
DCP32021	447150-3660
DCP50250	447150-3680
DCP32061	447150-3700
DCP32061	447150-3702
DCP50310	447150-3740
DCP50312	447150-3750
DCP50319	447150-3770
DCP50308	447150-3780
DCP50309	447150-3810
DCP09032	447150-3930
DCP21015	447150-3940
DCP21015	447150-3941
DCP17050	447150-3950
DCP17053	447150-3960
DCP17045	447150-3970
DCP17130	447150-3980
DCP17139	447150-3990
DCP17062	447150-4000
DCP17138	447150-4010
DCP17063	447150-4020
DCP17143	447150-4040
DCP50311	447150-4130
DCP50311	447150-4133
DCP32060	447150-4200
DCP02097	447150-4280
DCP02105	447150-4290
DCP02102	447150-4300
DCP17165	447150-4320
DCP17166	447150-4330
DCP17167	447150-4340
DCP17168	447150-4350
DCP17156	447150-4360
DCP17156	447150-4364
DCP28017	447150-4380
DCP17182	447150-4390
DCP17112	447150-4470
DCP17152	447150-4490
DCP50313	447150-4530
DCP09032	447150-4540
DCP50241	447150-4550
DCP17120	447150-4560
DCP09032	447150-4570
DCP09032	447150-4670
DCP09034	447150-4670
DCP21016	447150-4720
DCP21017	447150-4730
DCP50313	447150-4740
DCP50101	447150-4880
DCP02104	447150-4940
DCP28018	447150-4980
DCP50309	447150-4990
DCP05033	447150-5030
DCP17067	447150-5040
DCP17068	447150-5050
DCP17055	447150-5060
DCP17063	447150-5070
DCP17133	447150-5100
DCP17071	447150-5110
DCP17146	447150-5120
DCP02015	447150-5140
DCP50314	447150-5190
DCP21022	447150-5200
DCP20121	447150-5220
DCP28012	447150-5340
DCP17025	447150-5380
DCP17067	447150-5390
DCP17059	447150-5400
DCP17070	447150-5420
DCP17107	447150-5430
DCP17109	447150-5440

Short Code	DENSO
DCP17073	447150-5460
DCP02030	447150-5470
DCP02109	447150-5480
DCP05084	447150-5580
DCP20122	447150-5590
DCP20120	447150-5600
DCP20121	447150-5610
DCP20122	447150-5620
DCP02097	447150-5630
DCP02105	447150-5650
DCP17171	447150-5690
DCP28018	447150-5700
DCP05114	447150-5710
DCP05105	447150-5720
DCP20120	447150-5780
DCP47009	447150-5790
DCP50312	447150-5890
DCP21016	447150-5900
DCP21023	447150-5900
DCP50302	447150-5910
DCP32060	447150-6030
DCP32070	447150-6090
DCP05036	447150-6100
DCP05080	447150-6110
DCP32071	447150-6130
DCP02095	447150-6140
DCP47010	447150-6220
DCP50313	447150-6240
DCP05098	447150-6280
DCP17102	447150-6290
DCP02103	447150-6310
DCP02099	447150-6320
DCP50311	447150-6340
DCP05097	447150-6490
DCP32073	447150-6520
DCP32077	447150-6540
DCP28019	447150-6580
DCP50312	447150-6640
DCP50313	447150-6650
DCP17112	447150-6810
DCP32074	447150-6860
DCP20121	447150-6950
DCP20123	447150-6960
DCP20122	447150-6970
DCP20120	447150-6990
DCP20121	447150-7000
DCP20123	447150-7010
DCP20122	447150-7020
DCP20120	447150-7040
DCP32075	447150-7070
DCP32060	447150-7340
DCP21024	447150-7360
DCP09062	447150-7450
DCP09063	447150-7460
DCP09064	447150-7470
DCP02106	447150-7480
DCP02106	447150-7490
DCP50318	447150-7570
DCP50317	447150-7590
DCP32076	447150-7670
DCP50313	447150-7680
DCP50314	447150-7760
DCP32060	447150-7950
DCP21022	447150-8060
DCP21021	447150-8100
DCP50088	447160-0070
DCP02006	447160-0260
DCP32001	447160-0320
DCP05016	447160-0340
DCP17035	447160-0350
DCP06029	447160-0610

Short Code	DENSO
DCP99800	447160-0710
DCP99801	447160-0720
DCP17036	447160-0790
DCP17113	447160-0860
DCP12003	447160-0870
DCP05076	447160-0930
DCP13010	447160-1110
DCP01015	447160-1120
DCP05077	447160-1210
DCP05081	447160-1230
DCP05082	447160-1620
DCP05093	447160-1640
DCP50092	447160-1680
DCP50093	447160-1730
DCP17501	447160-1820
DCP50125	447160-1870
DCP50125	447160-1872
DCP50125	447160-1880
DCP50126	447160-1950
DCP50092	447160-1970
DCP50093	447160-2020
DCP17508	447160-2130
DCP05039	447160-2160
DCP05040	447160-2170
DCP17157	447160-2360
DCP17157	447160-2368
DCP36004	447160-2510
DCP50131	447160-2620
DCP50132	447160-2630
DCP40018	447160-3020
DCP05095	447160-3030
DCP05095	447160-3035
DCP17125	447160-3090
DCP50125	447160-3240
DCP50125	447160-3250
DCP50126	447160-3270
DCP17140	447160-3400
DCP17176	447160-3410
DCP17148	447160-3420
DCP05078	447160-3480
DCP05088	447160-3750
DCP99530	447160-3760
DCP99520	447160-4050
DCP05096	447160-4100
DCP05104	447160-4280
DCP05095	447160-4290
DCP17035	447160-4300
DCP17036	447160-4310
DCP17140	447160-4340
DCP17154	447160-4360
DCP17154	447160-4364
DCP12012	447160-4490
DCP17181	447160-4550
DCP99023	447160-4660
DCP17186	447160-4870
DCP50315	447160-4890
DCP05017	447160-5170
DCP05018	447160-5180
DCP05019	447160-5190
DCP02004	447160-5210
DCP02101	447160-5310
DCP23034	447160-5780
DCP23035	447160-5790
DCP02098	447160-5930
DCP17185	447160-5970
DCP17178	447160-5980
DCP17169	447160-5990
DCP17177	447160-6000
DCP17155	447160-6010
DCP17155	447160-6012
DCP17179	447160-6020

Short Code	DENSO
DCP40017	447160-6080
DCP17024	447160-6310
DCP50092	447160-6490
DCP50092	447160-6491
DCP50093	447160-6550
DCP47011	447160-6770
DCP47011	447160-6771
DCP46020	447160-6880
DCP46020	447160-6890
DCP46021	447160-6920
DCP46022	447160-6930
DCP17151	447160-7070
DCP50092	447160-7180
DCP50125	447160-7240
DCP50125	447160-7250
DCP02110	447160-7570
DCP32006	447160-7610
DCP17023	447160-8120
DCP17125	447160-8130
DCP17K37	447160-8140
DCP46024	447160-8410
DCP02098	447160-8470
DCP23539	447160-8500
DCP23540	447160-8510
DCP23541	447160-8520
DCP05115	447160-8730
DCP05106	447160-8740
DCP05050	447160-9770
DCP05076	447160-9780
DCP05077	447160-9790
DCP09007	447170-0050
DCP17064	447170-0090
DCP17064	447170-0091
DCP09003	447170-0560
DCP23002	447170-0660
DCP09001	447170-0690
DCP36006	447170-0760
DCP23530	447170-2310
DCP17025	447170-2320
DCP99510	447170-2400
DCP99003	447170-2530
DCP99003	447170-2580
DCP05014	447170-2820
DCP05013	447170-2830
DCP05016	447170-2850
DCP50021	447170-2860
DCP50025	447170-2890
DCP23531	447170-2900
DCP06003	447170-3090
DCP50031	447170-3400
DCP99527	447170-3470
DCP11003	447170-3630
DCP50087	447170-3650
DCP50073	447170-3700
DCP05001	447170-3750
DCP05003	447170-3770
DCP05004	447170-3780
DCP05006	447170-3810
DCP05007	447170-3820
DCP05008	447170-3830
DCP05009	447170-3840
DCP05010	447170-3860
DCP05003	447170-3880
DCP05010	447170-3890
DCP05012	447170-3930
DCP47007	447170-3940
DCP40002	447170-4040
DCP20004	447170-4830
DCP17034	447170-4910
DCP06009	447170-4970
DCP17036	447170-5000

Short Code	DENSO
DCP14006	447170-5060
DCP05014	447170-5370
DCP99005	447170-5380
DCP12009	447170-5430
DCP99810	447170-5480
DCP01001	447170-5500
DCP51000	447170-5530
DCP05013	447170-5540
DCP25001	447170-5550
DCP14018	447170-5640
DCP24004	447170-5650
DCP24005	447170-5660
DCP17023	447170-5730
DCP17024	447170-5740
DCP05016	447170-5770
DCP50090	447170-5790
DCP51015	447170-5850
DCP05014	447170-5940
DCP05017	447170-5960
DCP27001	447170-6170
DCP50026	447170-6210
DCP06017	447170-6270
DCP06017	447170-6280
DCP02004	447170-6290
DCP01001	447170-6300
DCP02005	447170-6340
DCP02006	447170-6350
DCP32001	447170-6360
DCP02007	447170-6370
DCP50060	447170-6600
DCP45008	447170-6640
DCP99831	447170-6720
DCP17505	447170-6940
DCP50115	447170-6950
DCP17026	447170-7000
DCP17025	447170-7060
DCP17038	447170-7150
DCP17064	447170-7180
DCP47006	447170-7250
DCP47003	447170-7260
DCP06016	447170-7360
DCP50081	447170-7380
DCP50014	447170-7410
DCP28008	447170-7420
DCP50115	447170-7510
DCP20004	447170-7550
DCP20005	447170-7560
DCP14018	447170-7570
DCP02047	447170-7580
DCP17025	447170-7640
DCP50020	447170-7650
DCP50022	447170-7660
DCP17023	447170-7680
DCP05018	447170-7690
DCP05013	447170-7700
DCP06025	447170-7810
DCP45009	447170-7850
DCP17114	447170-7860
DCP02045	447170-7900
DCP02010	447170-7910
DCP02048	447170-7920
DCP02061	447170-7930
DCP02008	447170-7940
DCP23535	447170-7970
DCP17153	447170-8000
DCP45014	447170-8010
DCP45012	447170-8020
DCP45011	447170-8030
DCP17080	447170-8060
DCP50040	447170-8140
DCP05046	447170-8180

Short Code	DENSO
DCP05021	447170-8200
DCP05107	447170-8210
DCP05094	447170-8220
DCP14018	447170-8230
DCP24004	447170-8240
DCP24005	447170-8250
DCP14007	447170-8280
DCP14008	447170-8290
DCP14018	447170-8310
DCP17026	447170-8330
DCP17144	447170-8340
DCP05014	447170-8430
DCP05014	447170-8440
DCP05016	447170-8450
DCP12004	447170-8600
DCP12005	447170-8610
DCP20003	447170-8640
DCP20004	447170-8650
DCP20005	447170-8660
DCP47003	447170-8670
DCP32052	447170-8680
DCP17035	447170-8770
DCP17092	447170-8790
DCP20006	447170-8920
DCP99505	447170-8930
DCP50001	447170-8940
DCP09002	447170-8950
DCP09008	447170-8960
DCP02046	447170-9080
DCP02011	447170-9090
DCP99821	447170-9100
DCP17036	447170-9110
DCP17113	447170-9140
DCP05017	447170-9230
DCP05018	447170-9240
DCP05019	447170-9250
DCP02013	447170-9380
DCP20030	447170-9420
DCP50220	447170-9440
DCP50221	447170-9450
DCP50222	447170-9460
DCP50223	447170-9470
DCP06012	447170-9480
DCP99517	447170-9490
DCP50095	447170-9510
DCP17063	447170-9780
DCP99020	447170-9820
DCP17043	447170-9900
DCP17043	447170-9903
DCP17041	447170-9910
DCP15001	447180-2790
DCP17050	447180-2860
DCP17031	447180-2880
DCP47001	447180-2890
DCP99802	447180-2900
DCP17023	447180-3010
DCP17025	447180-3020
DCP17025	447180-3021
DCP17010	447180-3060
DCP05039	447180-3130
DCP05039	447180-3140
DCP11007	447180-3190
DCP27002	447180-3200
DCP32023	447180-3310
DCP47003	447180-3320
DCP99512	447180-3480
DCP11045	447180-3500
DCP11010	447180-3510
DCP17026	447180-3550
DCP17180	447180-3580
DCP32006	447180-3600

Short Code	DENSO
DCP32006K	447180-3600
DCP17085	447180-3750
DCP28010	447180-3760
DCP02055	447180-3870
DCP32006	447180-3900
DCP32006K	447180-3900
DCP06003	447180-3920
DCP06009	447180-3960
DCP99002	447180-3970
DCP99001	447180-3980
DCP06006	447180-3990
DCP17026	447180-4040
DCP50100	447180-4090
DCP17043	447180-4130
DCP17043	447180-4139
DCP17102	447180-4140
DCP17026	447180-4150
DCP02010	447180-4270
DCP02010	447180-4280
DCP02011	447180-4290
DCP11011	447180-4320
DCP32003	447180-4340
DCP17508	447180-4360
DCP17508	447180-4369
DCP17039	447180-4440
DCP17038	447180-4450
DCP17051	447180-4470
DCP50120	447180-4510
DCP50122	447180-4520
DCP02009	447180-4550
DCP06026	447180-4590
DCP50006	447180-4610
DCP06021	447180-4620
DCP40012	447180-4670
DCP17160	447180-4700
DCP02025	447180-4720
DCP02091	447180-4730
DCP17064	447180-4750
DCP17064	447180-4759
DCP05022	447180-4760
DCP12003	447180-4900
DCP50009	447180-4920
DCP06016	447180-4940
DCP06017	447180-4950
DCP06017	447180-4960
DCP99528	447180-5180
DCP17039	447180-5240
DCP50103	447180-5260
DCP50097	447180-5320
DCP02010	447180-5350
DCP02061	447180-5360
DCP02011	447180-5370
DCP50102	447180-5390
DCP50130	447180-5410
DCP50085	447180-5420
DCP50086	447180-5430
DCP99523	447180-5480
DCP17102	447180-5510
DCP32003	447180-5530
DCP50074	447180-5540
DCP05032	447180-5590
DCP50121	447180-5640
DCP17026	447180-5650
DCP36002	447180-5670
DCP17125	447180-5680
DCP49002	447180-5740
DCP17059	447180-5870
DCP17058	447180-5880
DCP50001	447180-5940
DCP50002	447180-5970
DCP50006	447180-5990

Short Code	DENSO
DCP50011	447180-6140
DCP50013	447180-6160
DCP50116	447180-6190
DCP17026	447180-6220
DCP50004	447180-6300
DCP99513	447180-6380
DCP32045	447180-6390
DCP23025	447180-6490
DCP05038	447180-6530
DCP02038	447180-6580
DCP17070	447180-6640
DCP17071	447180-6650
DCP02012	447180-6700
DCP02023	447180-6710
DCP02024	447180-6720
DCP02025	447180-6730
DCP05020	447180-6760
DCP17038	447180-6800
DCP06020	447180-6890
DCP06016	447180-6930
DCP17046	447180-7040
DCP50120	447180-7200
DCP05032	447180-7260
DCP47004	447180-7270
DCP32020	447180-7280
DCP32005	447180-7290
DCP17054	447180-7330
DCP51003	447180-7400
DCP11008	447180-7460
DCP06018	447180-7520
DCP05021	447180-7550
DCP05107	447180-7560
DCP05079	447180-7570
DCP05037	447180-7580
DCP17038	447180-7650
DCP02016	447180-7700
DCP02016	447180-7710
DCP02014	447180-7720
DCP02015	447180-7730
DCP50226	447180-7780
DCP50082	447180-7790
DCP50033	447180-7820
DCP50030	447180-7840
DCP50032	447180-7850
DCP02015	447180-7860
DCP50083	447180-7880
DCP50224	447180-7890
DCP50225	447180-7900
DCP11012	447180-7920
DCP02035	447180-8090
DCP09004	447180-8100
DCP99525	447180-8180
DCP99518	447180-8200
DCP99803	447180-8270
DCP14012	447180-8360
DCP14013	447180-8370
DCP14014	447180-8380
DCP02034	447180-8450
DCP02027	447180-8470
DCP02039	447180-8480
DCP51002	447180-8530
DCP32022	447180-8590
DCP32031	447180-8600
DCP32051	447180-8610
DCP32006	447180-8620
DCP32006K	447180-8620
DCP50123	447180-8640
DCP50005	447180-8660
DCP50005	447180-8670
DCP50007	447180-8750
DCP50006	447180-8770

Short Code	DENSO
DCP50006	447180-8780
DCP50004	447180-8840
DCP50080	447180-8900
DCP05045	447180-8930
DCP50012	447180-9090
DCP50013	447180-9110
DCP50003	447180-9140
DCP50002	447180-9150
DCP50011	447180-9220
DCP50010	447180-9260
DCP44010	447180-9310
DCP50114	447180-9420
DCP50122	447180-9430
DCP02028	447180-9490
DCP02038	447180-9500
DCP05021	447180-9520
DCP36002	447180-9540
DCP36003	447180-9550
DCP05026	447180-9590
DCP17133	447180-9660
DCP17059	447180-9690
DCP17038	447180-9710
DCP17053	447180-9720
DCP17045	447180-9730
DCP17045	447180-9739
DCP17054	447180-9790
DCP17067	447180-9800
DCP50010	447180-9890
DCP17115	447180-9900
DCP17087	447180-9910
DCP17128	447180-9920
DCP17068	447180-9940
DCP17102	447180-9950
DCP17146	447180-9960
DCP17062	447180-9970
DCP09061	447190-1640
DCP09060	447190-1650
DCP45006	447190-2040
DCP40015	447190-2080
DCP32021	447190-2110
DCP09017	447190-2130
DCP20022	447190-2140
DCP09016	447190-2150
DCP99800	447190-2170
DCP17058	447190-2180
DCP50093	447190-2190
DCP17073	447190-2380
DCP50092	447190-2470
DCP05031	447190-2560
DCP05042	447190-2570
DCP50041	447190-2610
DCP05052	447190-2630
DCP17055	447190-3050
DCP17063	447190-3060
DCP51003	447190-3100
DCP02015	447190-3320
DCP17067	447190-3370
DCP17103	447190-3380
DCP17068	447190-3390
DCP02043	447190-3400
DCP02033	447190-3410
DCP02036	447190-3420
DCP02033	447190-3430
DCP17056	447190-3500
DCP36003	447190-3520
DCP36003	447190-3523
DCP28010	447190-3600
DCP02034	447190-3630
DCP02034	447190-3640
DCP32045	447190-3650
DCP50124	447190-3660

Short Code	DENSO
DCP36007	447190-3670
DCP36007	447190-3678
DCP15001	447190-3710
DCP05032	447190-3770
DCP05045	447190-3780
DCP02035	447190-3820
DCP02037	447190-3830
DCP02038	447190-3840
DCP99020	447190-3930
DCP99832	447190-4020
DCP47002	447190-4250
DCP02005	447190-4310
DCP02007	447190-4320
DCP32052	447190-4350
DCP27001	447190-4360
DCP50087	447190-4450
DCP51003	447190-4540
DCP05013	447190-4600
DCP32045	447190-4650
DCP40003	447190-4680
DCP32021	447190-4690
DCP17059	447190-4830
DCP17062	447190-4840
DCP17146	447190-4849
DCP17058	447190-4850
DCP17086	447190-4900
DCP02016	447190-4910
DCP02034	447190-4920
DCP02038	447190-4930
DCP02034	447190-4960
DCP06027	447190-4990
DCP50248	447190-5020
DCP20023	447190-5030
DCP20021	447190-5040
DCP20021K	447190-5040
DCP06022	447190-5050
DCP06022	447190-5060
DCP99807	447190-5130
DCP17121	447190-5140
DCP17150	447190-5150
DCP17122	447190-5160
DCP50301	447190-5200
DCP50240	447190-5220
DCP17071	447190-5230
DCP17070	447190-5240
DCP51001	447190-5300
DCP45003	447190-5350
DCP99801	447190-5400
DCP99809	447190-5410
DCP50122	447190-5450
DCP99822	447190-5470
DCP51016	447190-5480
DCP17034	447190-5500
DCP17092	447190-5510
DCP17035	447190-5520
DCP17036	447190-5530
DCP20022	447190-5550
DCP51004	447190-5640
DCP51004	447190-5642
DCP02004	447190-5670
DCP50076	447190-5750
DCP50245	447190-5940
DCP99524	447190-5970
DCP02030	447190-5980
DCP50042	447190-6000
DCP50035	447190-6090
DCP50039	447190-6100
DCP17026	447190-6160
DCP36002	447190-6170
DCP36003	447190-6190
DCP47002	447190-6230

Short Code	DENSO
DCP05026	447190-6260
DCP99830	447190-6270
DCP99830	447190-6271
DCP02033	447190-6360
DCP02034	447190-6370
DCP02033	447190-6380
DCP02034	447190-6390
DCP02063	447190-6400
DCP02035	447190-6410
DCP02036	447190-6420
DCP02016	447190-6430
DCP02037	447190-6440
DCP02014	447190-6450
DCP02038	447190-6460
DCP02038	447190-6470
DCP02039	447190-6480
DCP17143	447190-6570
DCP17060	447190-6580
DCP36001	447190-6590
DCP49001	447190-6620
DCP02040	447190-6670
DCP02041	447190-6680
DCP17065	447190-6740
DCP17142	447190-6760
DCP05033	447190-6870
DCP02042	447190-6900
DCP02043	447190-6910
DCP02015	447190-6920
DCP02044	447190-6930
DCP50246	447190-6940
DCP45004	447190-7050
DCP45005	447190-7060
DCP50302	447190-7130
DCP50300	447190-7140
DCP50301	447190-7150
DCP50301	447190-7151
DCP45013	447190-7200
DCP05020	447190-7210
DCP14019	447190-7230
DCP51002	447190-7260
DCP99022	447190-7400
DCP99519	447190-7460
DCP32067	447190-7470
DCP40004	447190-7500
DCP05031	447190-7530
DCP32021	447190-7560
DCP32006	447190-7570
DCP32022	447190-7580
DCP32031	447190-7590
DCP32051	447190-7600
DCP32006	447190-7610
DCP32006K	447190-7610
DCP32020	447190-7620
DCP32005	447190-7630
DCP17070	447190-7690
DCP17071	447190-7700
DCP17041	447190-7720
DCP17160	447190-7740
DCP17039	447190-7750
DCP05020	447190-7760
DCP02045	447190-7780
DCP02046	447190-7790
DCP50306	447190-7800
DCP50306	447190-7802
DCP17023	447190-7810
DCP17024	447190-7820
DCP02047	447190-7830
DCP02014	447190-7850
DCP05034	447190-7880
DCP05102	447190-7890
DCP50306	447190-7900

Short Code	DENSO
DCP05060	447190-7920
DCP32045	447190-7950
DCP05108	447190-7970
DCP17K37	447190-8030
DCP50249	447190-8040
DCP02048	447190-8050
DCP02016	447190-8060
DCP05035	447190-8070
DCP50243	447190-8090
DCP50243	447190-8092
DCP21021	447190-8110
DCP21014	447190-8120
DCP05083	447190-8210
DCP17072	447190-8230
DCP17125	447190-8250
DCP05094	447190-8270
DCP17026	447190-8280
DCP17043	447190-8290
DCP17085	447190-8300
DCP17039	447190-8310
DCP17102	447190-8320
DCP17026	447190-8330
DCP17026	447190-8360
DCP17064	447190-8370
DCP17063	447190-8420
DCP17135	447190-8440
DCP05050	447190-8460
DCP05061	447190-8470
DCP05084	447190-8520
DCP05036	447190-8540
DCP50228	447190-8600
DCP99017	447190-8610
DCP17026	447190-8630
DCP17144	447190-8640
DCP17153	447190-8650
DCP17064	447190-8670
DCP02008	447190-8680
DCP02055	447190-8690
DCP27002	447190-8700
DCP32002	447190-8710
DCP32003	447190-8720
DCP32020	447190-8890
DCP32005	447190-8900
DCP32021	447190-8950
DCP02015	447190-8990
DCP23537	447190-9050
DCP32022	447190-9080
DCP50248	447190-9170
DCP50240	447190-9180
DCP50246	447190-9192
DCP02050	447190-9200
DCP17073	447190-9280
DCP05037	447190-9340
DCP17025	447190-9360
DCP17050	447190-9370
DCP17080	447190-9380
DCP17102	447190-9390
DCP05014	447190-9440
DCP05015	447190-9450
DCP05052	447190-9500
DCP05038	447190-9520
DCP32023	447190-9550
DCP02013	447190-9560
DCP02028	447190-9570
DCP02009	447190-9580
DCP02091	447190-9590
DCP02015	447190-9610
DCP28008	447190-9620
DCP05021	447190-9650
DCP17101	447190-9670
DCP17100	447190-9680

Short Code	DENSO
DCP17104	447190-9690
DCP09020	447190-9700
DCP02052	447190-9730
DCP02052	447190-9740
DCP02052	447190-9750
DCP50241	447190-9780
DCP05062	447190-9950
DCP17031	447200-0010
DCP17033	447200-0010
DCP17034	447200-0010
DCP17084	447200-0010
DCP17092	447200-0010
DCP17505	447200-0010
DCP17012	447200-0020
DCP17013	447200-0020
DCP23538	447200-0090
DCP99504	447200-0090
DCP99505	447200-0090
DCP28004	447200-0100
DCP17095	447200-0200
DCP99810	447200-0240
DCP99820	447200-0240
DCP99810	447200-0246
DCP45010	447200-0530
DCP99502	447200-0680
DCP50050	447200-0800
DCP50071	447200-0980
DCP50023	447200-1200
DCP50024	447200-1210
DCP50025	447200-1210
DCP23530	447200-1440
DCP50021	447200-1590
DCP23531	447200-1600
DCP50031	447200-1630
DCP50073	447200-1710
DCP23535	447200-2200
DCP99505	447200-2230
DCP17505	447200-2290
DCP99505	447200-2300
DCP99512	447200-2300
DCP99513	447200-2480
DCP23537	447200-2690
DCP17010	447200-3000
DCP17011	447200-3010
DCP99002	447200-3030
DCP05001	447200-3070
DCP05008	447200-3070
DCP99510	447200-3080
DCP99530	447200-3080
DCP06001	447200-3090
DCP05003	447200-3200
DCP05004	447200-3210
DCP05009	447200-3210
DCP05006	447200-3310
DCP99001	447200-3340
DCP05003	447200-3380
DCP05010	447200-3390
DCP05007	447200-3400
DCP14001	447200-3420
DCP14003	447200-3420
DCP14002	447200-3430
DCP99003	447200-3470
DCP99521	447200-3660
DCP99522	447200-3660
DCP50078	447200-3720
DCP50078	447200-3726
DCP06002	447200-3740
DCP05012	447200-3920
DCP11001	447200-4140
DCP99004	447200-4150
DCP06003	447200-4180

Short Code	DENSO
DCP06006	447200-4200
DCP06006	447200-4210
DCP11002	447200-4500
DCP17019	447200-4540
DCP17020	447200-4540
DCP50078	447200-4550
DCP05010	447200-4660
DCP06009	447200-4680
DCP14004	447200-4800
DCP14005	447200-4810
DCP12004	447200-4820
DCP12005	447200-4820
DCP12008	447200-4820
DCP99510	447200-4930
DCP99511	447200-4930
DCP99530	447200-4930
DCP14006	447200-4960
DCP99510	447200-5030
DCP99003	447200-5130
DCP99003	447200-5140
DCP06003	447200-5240
DCP99002	447200-5350
DCP99001	447200-5360
DCP50074	447200-5400
DCP11003	447200-5420
DCP11007	447200-5420
DCP06009	447200-5520
DCP99005	447200-5620
DCP06005	447200-5660
DCP06006	447200-5670
DCP06003	447200-5700
DCP12009	447200-5750
DCP99517	447200-5960
DCP17005	447200-6000
DCP17006	447200-6000
DCP17008	447200-6000
DCP17007	447200-6010
DCP17008	447200-6010
DCP17015	447200-6010
DCP17147	447200-6010
DCP28006	447200-6050
DCP17017	447200-6270
DCP17147	447200-6270
DCP50087	447200-6540
DCP50087	447200-6544
DCP50087	447200-6860
DCP50099	447200-7050
DCP47008	447200-7070
DCP99B03	447200-8580
DCP24001	447200-9030
DCP17014	447200-9050
DCP20001	447200-9070
DCP13001	447200-9150
DCP05017	447200-9500
DCP02005	447200-9570
DCP28008	447200-9610
DCP17023	447200-9620
DCP17036	447200-9620
DCP02006	447200-9630
DCP32001	447200-9630
DCP02004	447200-9680
DCP17023	447200-9690
DCP20006	447200-9700
DCP25001	447200-9720
DCP05017	447200-9750
DCP05018	447200-9750
DCP17025	447200-9760
DCP05013	447200-9790
DCP05014	447200-9790
DCP05016	447200-9800
DCP02063	447200-9960

Short Code	DENSO
DCP02005	447200-9990
DCP17021	447220-0180
DCP50100	447220-1450
DCP51000	447220-3170
DCP50090	447220-3240
DCP05046	447220-3320
DCP47003	447220-3390
DCP50026	447220-3430
DCP06017	447220-3450
DCP06017	447220-3460
DCP50060	447220-3610
DCP45011	447220-3630
DCP45009	447220-3650
DCP45008	447220-3656
DCP99800	447220-3840
DCP99802	447220-3840
DCP99803	447220-3840
DCP99807	447220-3840
DCP47001	447220-3850
DCP47006	447220-3850
DCP47006	447220-3853
DCP06016	447220-3870
DCP50081	447220-3890
DCP50020	447220-3910
DCP50022	447220-3920
DCP50033	447220-3930
DCP50030	447220-3950
DCP06025	447220-3970
DCP06025	447220-3975
DCP45009	447220-3990
DCP45009	447220-3994
DCP17114	447220-4000
DCP45014	447220-4020
DCP45012	447220-4030
DCP99821	447220-4050
DCP99822	447220-4050
DCP50040	447220-4060
DCP50041	447220-4060
DCP14007	447220-4080
DCP14008	447220-4080
DCP47003	447220-4140
DCP50226	447220-4190
DCP50226	447220-4193
DCP50220	447220-4200
DCP50221	447220-4210
DCP50224	447220-4210
DCP50222	447220-4220
DCP50225	447220-4220
DCP50083	447220-4230
DCP50223	447220-4230
DCP50095	447220-4240
DCP50095	447220-4242
DCP06012	447220-4280
DCP50032	447220-4300
DCP15001	447220-4360
DCP15001	447220-4366
DCP50082	447220-4390
DCP99020	447220-4410
DCP99020	447220-4416
DCP47003	447220-4570
DCP99518	447220-4620
DCP06026	447220-4820
DCP06026	447220-4824
DCP06021	447220-4840
DCP40012	447220-4860
DCP06016	447220-4980
DCP06016	447220-4985
DCP06017	447220-4990
DCP06017	447220-5000
DCP50103	447220-5130
DCP50097	447220-5190

Short Code	DENSO
DCP50097	447220-5192
DCP50130	447220-5260
DCP50085	447220-5270
DCP50086	447220-5280
DCP06027	447220-5560
DCP06027	447220-5565
DCP06020	447220-5600
DCP06020	447220-5605
DCP06016	447220-5630
DCP47004	447220-5800
DCP06018	447220-5870
DCP40003	447220-5900
DCP50115	447220-6060
DCP99831	447220-6060
DCP50014	447220-6240
DCP50115	447220-6250
DCP50011	447220-6360
DCP50013	447220-6360
DCP50015	447220-6360
DCP50012	447220-6380
DCP50005	447220-6530
DCP50004	447220-6540
DCP50005	447220-6540
DCP99524	447220-6590
DCP50006	447220-6660
DCP49002	447220-6900
DCP09005	447220-6940
DCP23002	447220-6960
DCP12001	447220-6970
DCP09007	447220-6990
DCP06003	447220-7180
DCP06009	447220-7200
DCP99001	447220-7210
DCP99002	447220-7210
DCP06006	447220-7220
DCP99521	447220-7270
DCP99522	447220-7270
DCP12003	447220-7290
DCP99523	447220-7410
DCP99525	447220-7570
DCP99022	447220-7700
DCP17501	447220-7920
DCP17064	447220-8000
DCP17064	447220-8001
DCP20003	447220-8010
DCP05013	447220-8020
DCP05014	447220-8020
DCP05039	447220-8020
DCP05040	447220-8020
DCP01001	447220-8030
DCP25001	447220-8040
DCP14018	447220-8050
DCP24004	447220-8050
DCP24005	447220-8060
DCP17023	447220-8080
DCP17080	447220-8080
DCP17024	447220-8090
DCP17035	447220-8090
DCP17036	447220-8090
DCP17508	447220-8090
DCP17B35	447220-8090
DCP17K37	447220-8090
DCP05016	447220-8110
DCP27001	447220-8120
DCP20004	447220-8130
DCP02004	447220-8140
DCP02047	447220-8140
DCP01001	447220-8150
DCP02005	447220-8170
DCP02006	447220-8180
DCP32001	447220-8180

Short Code	DENSO
DCP02007	447220-8190
DCP17026	447220-8220
DCP17144	447220-8220
DCP17153	447220-8220
DCP17063	447220-8250
DCP28008	447220-8260
DCP05019	447220-8280
DCP20004	447220-8310
DCP20005	447220-8320
DCP14018	447220-8330
DCP02005	447220-8350
DCP02006	447220-8350
DCP32001	447220-8350
DCP17025	447220-8360
DCP02045	447220-8390
DCP02010	447220-8400
DCP02048	447220-8410
DCP02010	447220-8420
DCP02061	447220-8420
DCP02008	447220-8430
DCP50001	447220-8460
DCP05021	447220-8470
DCP05107	447220-8480
DCP05094	447220-8490
DCP14018	447220-8500
DCP24004	447220-8500
DCP24005	447220-8510
DCP14018	447220-8530
DCP32052	447220-8570
DCP20003	447220-8590
DCP20004	447220-8600
DCP20005	447220-8610
DCP09002	447220-8630
DCP09008	447220-8640
DCP02046	447220-8670
DCP02011	447220-8680
DCP17113	447220-8700
DCP17125	447220-8700
DCP17B29	447220-8700
DCP20006	447220-8740
DCP05017	447220-8750
DCP05018	447220-8750
DCP05019	447220-8760
DCP02013	447220-8810
DCP17038	447220-8840
DCP17041	447220-8850
DCP17043	447220-8850
DCP17043	447220-8859
DCP17050	447220-8870
DCP17046	447220-8880
DCP27002	447220-8940
DCP20030	447220-8950
DCP50009	447220-8990
DCP50009	447220-8994
DCP32023	447220-9010
DCP11045	447220-9030
DCP11010	447220-9040
DCP17026	447220-9050
DCP17180	447220-9080
DCP32006	447220-9090
DCP32006K	447220-9090
DCP17085	447220-9100
DCP28010	447220-9110
DCP02055	447220-9120
DCP32006	447220-9130
DCP32006K	447220-9130
DCP17026	447220-9140
DCP17026	447220-9150
DCP17043	447220-9150
DCP17102	447220-9150
DCP17043	447220-9159

Short Code	DENSO
DCP11011	447220-9180
DCP32003	447220-9200
DCP17039	447220-9220
DCP17064	447220-9220
DCP17064	447220-9229
DCP17038	447220-9230
DCP50120	447220-9240
DCP50122	447220-9240
DCP50306	447220-9240
DCP50120	447220-9249
DCP50122	447220-9249
DCP50306	447220-9249
DCP17051	447220-9250
DCP02009	447220-9260
DCP02025	447220-9260
DCP02091	447220-9280
DCP17026	447220-9300
DCP17160	447220-9300
DCP05022	447220-9310
DCP17038	447220-9320
DCP17026	447220-9330
DCP17039	447220-9330
DCP17102	447220-9330
DCP17146	447220-9330
DCP17102	447220-9339
DCP32003	447220-9350
DCP05052	447220-9360
DCP05020	447220-9370
DCP05037	447220-9370
DCP50121	447220-9390
DCP50124	447220-9390
DCP50124	447220-9399
DCP50121	447220-9460
DCP32003	447220-9470
DCP23025	447220-9480
DCP05038	447220-9500
DCP05021	447220-9510
DCP02038	447220-9530
DCP17070	447220-9540
DCP17071	447220-9540
DCP02012	447220-9560
DCP02023	447220-9570
DCP02024	447220-9580
DCP02025	447220-9590
DCP02010	447220-9600
DCP02026	447220-9600
DCP05032	447220-9670
DCP17054	447220-9680
DCP45003	447220-9680
DCP32020	447220-9690
DCP32005	447220-9700
DCP51003	447220-9710
DCP51003	447220-9712
DCP50246	447220-9730
DCP50248	447220-9730
DCP05033	447220-9760
DCP05079	447220-9760
DCP05107	447220-9760
DCP17038	447220-9790
DCP02014	447220-9800
DCP02016	447220-9800
DCP02036	447220-9800
DCP02037	447220-9800
DCP02090	447220-9800
DCP02033	447220-9810
DCP02034	447220-9810
DCP02027	447220-9820
DCP02033	447220-9820
DCP02034	447220-9820
DCP02015	447220-9830
DCP02015	447220-9840

Short Code	DENSO
DCP11012	447220-9850
DCP02035	447220-9880
DCP50306	447220-9910
DCP50120	447220-9919
DCP50306	447220-9919
DCP14012	447220-9930
DCP14013	447220-9930
DCP14014	447220-9940
DCP02063	447220-9960
DCP02039	447220-9970
DCP50313	447250-0350
DCP50311	447250-0410
DCP32073	447250-0870
DCP32077	447250-0890
DCP20122	447250-1070
DCP20120	447250-1080
DCP17143	447250-1180
DCP32075	447250-1440
DCP46025	447250-1490
DCP20122	447250-1950
DCP20121	447250-1960
DCP20122	447250-1970
DCP20120	447250-2000
DCP21024	447250-2020
DCP09062	447250-2330
DCP09063	447250-2330
DCP09064	447250-2340
DCP50317	447250-2500
DCP50318	447250-2500
DCP32076	447250-2650
DCP50313	447250-2660
DCP32060	447250-2790
DCP20121	447250-3240
DCP20122	447250-3250
DCP20122	447250-3260
DCP20120	447250-3280
DCP11008	447260-0040
DCP51002	447260-0090
DCP51002	447260-0091
DCP32022	447260-0110
DCP32031	447260-0120
DCP32051	447260-0130
DCP32006	447260-0140
DCP32006K	447260-0140
DCP50123	447260-0150
DCP05045	447260-0160
DCP05026	447260-0170
DCP50114	447260-0190
DCP50122	447260-0190
DCP02028	447260-0200
DCP02034	447260-0200
DCP02038	447260-0200
DCP02043	447260-0200
DCP02065	447260-0200
DCP17059	447260-0210
DCP17133	447260-0210
DCP17045	447260-0220
DCP17053	447260-0220
DCP17067	447260-0220
DCP17045	447260-0229
DCP17038	447260-0230
DCP17103	447260-0260
DCP17067	447260-0270
DCP17068	447260-0270
DCP17105	447260-0270
DCP17068	447260-0290
DCP17102	447260-0300
DCP32021	447260-0340
DCP09017	447260-0350
DCP20021	447260-0360
DCP20021K	447260-0360

Short Code	DENSO
DCP20022	447260-0360
DCP09016	447260-0370
DCP09020	447260-0370
DCP17058	447260-0390
DCP17059	447260-0390
DCP17062	447260-0390
DCP17073	447260-0410
DCP05031	447260-0450
DCP32052	447260-0470
DCP17055	447260-0480
DCP17063	447260-0480
DCP51003	447260-0490
DCP51003	447260-0492
DCP02015	447260-0580
DCP17071	447260-0600
DCP17056	447260-0620
DCP28010	447260-0630
DCP17067	447260-0650
DCP17086	447260-0659
DCP51003	447260-0730
DCP51003	447260-0737
DCP27001	447260-0770
DCP05013	447260-0780
DCP05014	447260-0780
DCP05039	447260-0780
DCP02007	447260-0790
DCP32045	447260-0800
DCP32021	447260-0840
DCP17058	447260-0850
DCP17059	447260-0850
DCP17062	447260-0850
DCP17146	447260-0859
DCP20023	447260-0890
DCP06022	447260-0900
DCP17071	447260-0930
DCP17070	447260-0940
DCP50240	447260-0950
DCP05042	447260-0960
DCP51001	447260-0970
DCP50301	447260-1020
DCP50122	447260-1060
DCP51004	447260-1100
DCP51004	447260-1107
DCP50245	447260-1170
DCP50245	447260-1178
DCP06022	447260-1180
DCP50039	447260-1200
DCP50042	447260-1200
DCP50035	447260-1250
DCP50301	447260-1250
DCP17026	447260-1260
DCP05026	447260-1280
DCP51001	447260-1290
DCP17060	447260-1300
DCP17143	447260-1309
DCP02040	447260-1310
DCP02042	447260-1310
DCP02041	447260-1320
DCP02052	447260-1320
DCP17065	447260-1350
DCP17142	447260-1370
DCP17142	447260-1379
DCP02042	447260-1420
DCP32061	447260-1420
DCP32061	447260-1425
DCP02043	447260-1430
DCP02044	447260-1430
DCP02015	447260-1440
DCP51002	447260-1460
DCP51002	447260-1461
DCP51002	447260-1462

Short Code	DENSO
DCP50228	447260-1490
DCP50302	447260-1490
DCP50240	447260-1500
DCP50242	447260-1500
DCP50246	447260-1500
DCP50248	447260-1500
DCP50300	447260-1500
DCP50242	447260-1506
DCP20022	447260-1510
DCP20121	447260-1510
DCP14019	447260-1520
DCP17070	447260-1550
DCP17071	447260-1560
DCP05034	447260-1570
DCP50249	447260-1580
DCP50242	447260-1581
DCP32020	447260-1590
DCP32021	447260-1600
DCP32006	447260-1610
DCP32006K	447260-1610
DCP32022	447260-1620
DCP05060	447260-1630
DCP32006	447260-1660
DCP32031	447260-1670
DCP32051	447260-1680
DCP32051	447260-1686
DCP32005	447260-1690
DCP32045	447260-1700
DCP05108	447260-1710
DCP50121	447260-1740
DCP50124	447260-1740
DCP05035	447260-1760
DCP50243	447260-1770
DCP50243	447260-1772
DCP50240	447260-1780
DCP17125	447260-1800
DCP05083	447260-1810
DCP17063	447260-1820
DCP17135	447260-1830
DCP05050	447260-1850
DCP05061	447260-1860
DCP17115	447260-1870
DCP17087	447260-1880
DCP17128	447260-1880
DCP05036	447260-1910
DCP21021	447260-1920
DCP21014	447260-1930
DCP32020	447260-1950
DCP32005	447260-1960
DCP32021	447260-1970
DCP32022	447260-2020
DCP14014	447260-2030
DCP50001	447260-2030
DCP50009	447260-2030
DCP17073	447260-2090
DCP17084	447260-2090
DCP05037	447260-2100
DCP27002	447260-2140
DCP02005	447260-2150
DCP17101	447260-2160
DCP17112	447260-2160
DCP17100	447260-2170
DCP17104	447260-2170
DCP50241	447260-2180
DCP05062	447260-2200
DCP20121	447260-2250
DCP28012	447260-2260
DCP28016	447260-2260
DCP28016	447260-2263
DCP50120	447260-2270
DCP50306	447260-2270

Short Code	DENSO
DCP02050	447260-2280
DCP17152	447260-2290
DCP17152	447260-2295
DCP17058	447260-2300
DCP17059	447260-2300
DCP17055	447260-2310
DCP17129	447260-2310
DCP50243	447260-2320
DCP50240	447260-2330
DCP50242	447260-2330
DCP50246	447260-2330
DCP50248	447260-2330
DCP50249	447260-2330
DCP50300	447260-2330
DCP50305	447260-2330
DCP50248	447260-2334
DCP50305	447260-2334
DCP17070	447260-2370
DCP17071	447260-2380
DCP11045	447260-2400
DCP11011	447260-2420
DCP05032	447260-2450
DCP05045	447260-2460
DCP05052	447260-2470
DCP05020	447260-2480
DCP05094	447260-2480
DCP05094	447260-2482
DCP32003	447260-2490
DCP32023	447260-2510
DCP05021	447260-2520
DCP05038	447260-2530
DCP32003	447260-2540
DCP02061	447260-2550
DCP02048	447260-2560
DCP02004	447260-2570
DCP02047	447260-2570
DCP02010	447260-2580
DCP02045	447260-2590
DCP02046	447260-2600
DCP17144	447260-2610
DCP17153	447260-2610
DCP17041	447260-2620
DCP05021	447260-2640
DCP17026	447260-2640
DCP17039	447260-2650
DCP17072	447260-2650
DCP06022	447260-2661
DCP05093	447260-2671
DCP06022	447260-2671
DCP05076	447260-2770
DCP05080	447260-2780
DCP02043	447260-2790
DCP02092	447260-2790
DCP05079	447260-2800
DCP17107	447260-2810
DCP17130	447260-2820
DCP17139	447260-2840
DCP17139	447260-2845
DCP17062	447260-2870
DCP17138	447260-2870
DCP17138	447260-2876
DCP17063	447260-2880
DCP50101	447260-2890
DCP50036	447260-2930
DCP50037	447260-2930
DCP50036	447260-2932
DCP17106	447260-2940
DCP17060	447260-2950
DCP17132	447260-2950
DCP17131	447260-2970
DCP17143	447260-2970

Short Code	DENSO
DCP17143	447260-2976
DCP05077	447260-2980
DCP05081	447260-2990
DCP13010	447260-3020
DCP01015	447260-3030
DCP23030	447260-3040
DCP23031	447260-3040
DCP23032	447260-3050
DCP32063	447260-3060
DCP17120	447260-3070
DCP17157	447260-3090
DCP17157	447260-3092
DCP07010	447260-3100
DCP17026	447260-3130
DCP17146	447260-3130
DCP05020	447260-3140
DCP05079	447260-3150
DCP05092	447260-3160
DCP05082	447260-3170
DCP05021	447260-3180
DCP05052	447260-3190
DCP05084	447260-3200
DCP05092	447260-3202
DCP05082	447260-3210
DCP05102	447260-3210
DCP05093	447260-3220
DCP17085	447260-3240
DCP17026	447260-3260
DCP17102	447260-3260
DCP17039	447260-3280
DCP17102	447260-3280
DCP17K37	447260-3290
DCP50304	447260-3310
DCP50304	447260-3313
DCP13005	447260-3340
DCP13005	447260-3341
DCP50125	447260-3350
DCP50125	447260-3351
DCP50126	447260-3360
DCP50123	447260-3380
DCP05016	447260-3430
DCP17025	447260-3450
DCP02008	447260-3460
DCP02011	447260-3470
DCP02009	447260-3480
DCP02025	447260-3480
DCP05033	447260-3490
DCP05079	447260-3490
DCP05107	447260-3490
DCP02014	447260-3500
DCP02016	447260-3500
DCP02036	447260-3500
DCP02037	447260-3500
DCP02090	447260-3500
DCP36002	447260-3660
DCP05033	447260-3670
DCP02060	447260-3690
DCP28014	447260-3700
DCP28014	447260-3701
DCP17109	447260-3720
DCP32050	447260-3730
DCP32050	447260-3731
DCP32069	447260-3740
DCP32071	447260-3750
DCP32071	447260-3753
DCP32062	447260-3760
DCP17112	447260-3770
DCP02042	447260-3780
DCP05091	447260-3810
DCP05091	447260-3812
DCP05095	447260-3820

Short Code	DENSO
DCP05095	447260-3822
DCP21021	447260-3830
DCP21014	447260-3840
DCP02034	447260-3850
DCP02095	447260-3850
DCP07010	447260-3870
DCP14020	447260-3880
DCP02099	447260-3890
DCP02103	447260-3890
DCP17126	447260-3900
DCP17126	447260-3903
DCP17127	447260-3910
DCP17127	447260-3913
DCP50101	447260-3940
DCP50101	447260-3943
DCP50101	447260-3944
DCP50125	447260-3950
DCP50126	447260-3960
DCP17053	447260-3990
DCP17159	447260-4030
DCP17163	447260-4030
DCP17182	447260-4030
DCP17140	447260-4040
DCP17148	447260-4050
DCP17176	447260-4050
DCP17181	447260-4053
DCP05089	447260-4060
DCP05090	447260-4070
DCP05078	447260-4080
DCP17161	447260-4160
DCP50250	447260-4200
DCP50251	447260-4200
DCP50252	447260-4200
DCP50253	447260-4200
DCP32061	447260-4210
DCP32061	447260-4211
DCP05088	447260-4230
DCP32022	447260-4260
DCP32071	447260-4270
DCP32071	447260-4272
DCP32031	447260-4280
DCP32055	447260-4280
DCP32031	447260-4281
DCP32064	447260-4290
DCP02096	447260-4300
DCP02095	447260-4320
DCP32074	447260-4500
DCP32065	447260-4510
DCP32072	447260-4520
DCP32072	447260-4521
DCP05096	447260-4530
DCP05097	447260-4540
DCP05104	447260-4690
DCP05098	447260-4700
DCP05095	447260-4710
DCP05099	447260-4720
DCP02013	447260-4760
DCP02038	447260-4770
DCP02091	447260-4780
DCP02035	447260-4790
DCP32068	447260-4830
DCP32070	447260-4890
DCP32066	447260-4900
DCP17162	447260-4960
DCP36002	447260-5000
DCP36003	447260-5010
DCP36003	447260-5011
DCP36003	447260-5290
DCP36003	447260-5292
DCP99832	447260-5350
DCP47002	447260-5430

# A/C Components

## Cross Reference Chart - Short Code > DENSO

Short Code	DENSO
DCP47002	447260-5692
DCP99830	447260-5780
DCP99830	447260-5781
DCP49001	447260-5820
DCP99017	447260-5900
DCP17140	447260-5980
DCP17140	447260-5982
DCP17154	447260-5990
DCP17154	447260-5992
DCP40003	447260-6080
DCP99807	447260-6120
DCP99809	447260-6120
DCP17121	447260-6130
DCP17122	447260-6130
DCP17150	447260-6130
DCP50076	447260-6250
DCP50076	447260-6251
DCP40004	447260-6340
DCP40004	447260-6342
DCP45013	447260-6480
DCP45004	447260-6490
DCP45005	447260-6500
DCP32067	447260-6560
DCP99526	447260-6570
DCP99519	447260-6571
DCP40012	447260-6980
DCP09001	447260-7000
DCP50011	447260-7100
DCP50013	447260-7100
DCP50002	447260-7270
DCP50006	447260-7291
DCP50116	447260-7300
DCP50116	447260-7301
DCP50004	447260-7360
DCP09004	447260-7760
DCP50007	447260-7810
DCP50006	447260-7840
DCP50010	447260-7850
DCP50002	447260-7880
DCP50003	447260-7880
DCP36001	447260-7940
DCP36002	447260-7940
DCP50010	447260-7960
DCP40002	447260-8000
DCP50092	447260-8020
DCP50093	447260-8040
DCP50080	447260-8090
DCP50226	447260-8120
DCP50082	447260-8130
DCP45006	447260-8350
DCP45006	447260-8351
DCP40015	447260-8370
DCP99800	447260-8390
DCP99801	447260-8390
DCP36007	447260-8740
DCP36007	447260-8746
DCP02030	447260-9090
DCP02050	447260-9090
DCP99023	447260-9180
DCP02016	447260-9800
DCP50088	447280-0050
DCP45011	447280-0070
DCP06029	447280-0170
DCP06029	447280-0171
DCP36004	447280-0930
DCP50131	447280-1070
DCP50132	447280-1080
DCP40018	447280-1230
DCP99520	447280-1650
DCP12012	447280-1800
DCP17186	447280-1840

Short Code	DENSO
DCP17185	447280-2160
DCP40017	447280-2170
DCP50092	447280-2310
DCP50092	447280-2470
DCP23539	447280-2700
DCP23540	447280-2700
DCP23541	447280-2710
DCP49001	447280-3150
DCP99017	447280-3160
DCP17051	447280-6070
DCP17067	447280-6110
DCP17158	447280-6180
DCP17158	447280-6181
DCP17164	447280-6190
DCP17038	447280-6240
DCP50101	447280-6290
DCP17508	447280-6320
DCP17B35	447280-6320
DCP02026	447280-6390
DCP32056	447280-6460
DCP32056	447280-6461
DCP02101	447280-6520
DCP50310	447280-6570
DCP50311	447280-6580
DCP50312	447280-6580
DCP50311	447280-6581
DCP50319	447280-6590
DCP50308	447280-6600
DCP50309	447280-6600
DCP28017	447280-6640
DCP09032	447280-6690
DCP21015	447280-6850
DCP21015	447280-6851
DCP32060	447280-6860
DCP23034	447280-6900
DCP23035	447280-6910
DCP17181	447280-6940
DCP02097	447280-7010
DCP02102	447280-7020
DCP02105	447280-7020
DCP02098	447280-7030
DCP17155	447280-7080
DCP17169	447280-7080
DCP17178	447280-7080
DCP17177	447280-7090
DCP17179	447280-7090
DCP17165	447280-7120
DCP17166	447280-7130
DCP17167	447280-7140
DCP17168	447280-7150
DCP17156	447280-7190
DCP21016	447280-7360
DCP09032	447280-7720
DCP09034	447280-7720
DCP50313	447280-7930
DCP17151	447280-7980
DCP05115	447280-8260
DCP05114	447280-8270
DCP05106	447280-8280
DCP05105	447280-8290
DCP47009	447280-8340
DCP51002	447280-8360
DCP17171	447280-8410
DCP20122	447280-8580
DCP20120	447280-8590
DCP21017	447280-8610
DCP50302	447280-8620
DCP32060	447280-8770
DCP02106	447280-8790
DCP02097	447280-8800
DCP02098	447280-8820

Short Code	DENSO
DCP02102	447280-8840
DCP47010	447280-8950
DCP50101	447280-9080
DCP50125	447280-9120
DCP02104	447280-9250
DCP28018	447280-9260
DCP50314	447280-9280
DCP02110	447280-9290
DCP46020	447280-9380
DCP46020	447280-9390
DCP46022	447280-9400
DCP46021	447280-9460
DCP21022	447280-9470
DCP02106	447280-9610
DCP02109	447280-9720
DCP17006	447300-0010
DCP17007	447300-0020
DCP17008	447300-0030
DCP17005	447300-0040
DCP17010	447300-0040
DCP17011	447300-0120
DCP17015	447300-0120
DCP99001	447300-0130
DCP99002	447300-0140
DCP17033	447300-0160
DCP14007	447300-0170
DCP17012	447300-0190
DCP17013	447300-0200
DCP50024	447300-0240
DCP28004	447300-0300
DCP28006	447300-0320
DCP99510	447300-0350
DCP99525	447300-0350
DCP24001	447300-0380
DCP23530	447300-0390
DCP23531	447300-0390
DCP99505	447300-0390
DCP99512	447300-0390
DCP06001	447300-0410
DCP06002	447300-0410
DCP99521	447300-0450
DCP99530	447300-0450
DCP17014	447300-0460
DCP50087	447300-0480
DCP05003	447300-0570
DCP50099	447300-0610
DCP50099	447300-0620
DCP47008	447300-0870
DCP09012	447300-0910
DCP09006	447300-0920
DCP09014	447300-0920
DCP09015	447300-0920
DCP36006	447300-0970
DCP99504	447300-1080
DCP99001	447300-1120
DCP99002	447300-1130
DCP50071	447300-1170
DCP17095	447300-1200
DCP14001	447300-1270
DCP14002	447300-1280
DCP14003	447300-1320
DCP20001	447300-1370
DCP99820	447300-1440
DCP99003	447300-1450
DCP99004	447300-1450
DCP50078	447300-1810
DCP99522	447300-2040
DCP50050	447300-2070
DCP17147	447300-2080
DCP45010	447300-2130
DCP13001	447300-2680

Short Code	DENSO
DCP99502	447300-2700
DCP09010	447300-2860
DCP17034	447300-3580
DCP17C36	447300-3580
DCP11001	447300-3710
DCP09011	447300-3940
DCP06003	447300-3960
DCP06006	447300-3980
DCP17023	447300-4170
DCP17017	447300-4630
DCP17147	447300-4650
DCP09009	447300-4660
DCP05014	447300-4710
DCP05016	447300-4710
DCP05018	447300-4710
DCP05013	447300-4720
DCP05017	447300-4720
DCP17017	447300-4780
DCP20003	447300-4810
DCP23535	447300-4850
DCP23538	447300-4850
DCP17084	447300-4960
DCP02005	447300-4970
DCP32001	447300-4970
DCP99523	447300-5080
DCP06009	447300-5110
DCP11002	447300-5380
DCP11003	447300-5380
DCP17019	447300-5550
DCP17020	447300-5560
DCP50021	447300-5650
DCP50025	447300-5950
DCP28008	447300-6000
DCP02006	447300-6040
DCP02004	447300-6140
DCP20006	447300-6180
DCP12001	447300-6220
DCP23002	447300-6220
DCP14005	447300-6260
DCP14004	447300-6270
DCP12008	447300-6340
DCP99511	447300-6370
DCP25001	447300-6390
DCP17021	447300-6480
DCP50031	447300-6620
DCP99003	447300-6770
DCP09007	447300-6900
DCP17025	447300-7070
DCP06003	447300-7130
DCP50073	447300-7230
DCP50074	447300-7230
DCP17064	447300-7250
DCP05001	447300-7400
DCP05007	447300-7410
DCP05003	447300-7420
DCP05004	447300-7430
DCP05010	447300-7430
DCP05006	447300-7460
DCP05008	447300-7480
DCP05009	447300-7500
DCP05012	447300-7520
DCP50087	447300-7590
DCP05014	447300-7670
DCP05016	447300-7670
DCP05018	447300-7670
DCP05019	447300-7670
DCP05013	447300-7680
DCP05017	447300-7680
DCP06005	447300-7800
DCP06006	447300-7800
DCP17036	447300-7820

# A/C Components

Cross Reference Chart - Short Code > DENSO

Short Code	DENSO
DCP17113	447300-7820
DCP40002	447300-7830
DCP40002	447300-7831
DCP50026	447300-7870
DCP14006	447300-7880
DCP20004	447300-7930
DCP20005	447300-7940
DCP50090	447300-7970
DCP99005	447300-8020
DCP47001	447300-8070
DCP15001	447300-8090
DCP99020	447300-8100
DCP99020	447300-8101
DCP12009	447300-8120
DCP99810	447300-8140
DCP01001	447300-8170
DCP51000	447300-8180
DCP14018	447300-8230
DCP24004	447300-8240
DCP24005	447300-8250
DCP45009	447300-8310
DCP05014	447300-8440
DCP17024	447300-8510
DCP09001	447300-8550
DCP99831	447300-8590
DCP50020	447300-8600
DCP50060	447300-8600
DCP45008	447300-8671
DCP50014	447300-8780
DCP02007	447300-8820
DCP27001	447300-8820
DCP27002	447300-8820
DCP17505	447300-8930
DCP06017	447300-8960
DCP50115	447300-8970
DCP17026	447300-8980
DCP17063	447300-8980
DCP17025	447300-9000
DCP17144	447300-9070
DCP17038	447300-9080
DCP17180	447300-9080
DCP36005	447300-9090
DCP47006	447300-9100
DCP47003	447300-9130
DCP47004	447300-9130
DCP09005	447300-9140
DCP06016	447300-9190
DCP06018	447300-9190
DCP50023	447300-9250
DCP50081	447300-9270
DCP50095	447300-9270
DCP50220	447300-9270
DCP50221	447300-9270
DCP50095	447300-9271
DCP50022	447300-9440
DCP06017	447300-9470
DCP06018	447300-9470
DCP02047	447300-9490
DCP50040	447300-9500
DCP02012	447300-9550
DCP02025	447300-9550
DCP02045	447300-9550
DCP02046	447300-9550
DCP02048	447300-9550
DCP02091	447300-9550
DCP32003	447300-9550
DCP02010	447300-9590
DCP02011	447300-9590
DCP02024	447300-9590
DCP02026	447300-9590
DCP02061	447300-9590

Short Code	DENSO
DCP02008	447300-9600
DCP02013	447300-9600
DCP02023	447300-9600
DCP14018	477220-8330
DCP09012	50777-0500
DCP09015	50777-0600
DCP09010	50777-2000
DCP09007	50777-5000
DCP09001	50777-5200
DCP01001	51207-0000
DCP13001	51207-0100
DCP01001	51207-4800
DCP13001	51270-1020
DCP01004	53107-0000
DCP01004	54407-0000
DCP09009	54407-0900
DCP09006	54407-1000
DCP09011	54407-1400
DCP12001	57067-5200
DCP23002	57067-5210
DCP09005	59247-5600
DCP09001	59247-5700
DCP09005	59247-5900
DCP09001	59247-6000
DCP09007	59257-5000
DCP09002	5A007-5000
DCP09004	5A787-5000
DCP09004	5A787-5200
DCP09003	5A797-5600
DCP09008	5A797-5700
DCP09017	5D337-5000
DCP20023	5D337-5300
DCP20023	5E5275600
DCP05090	BWK486
DCP21021	DCP21012



# DENSO Condensers

