

8 Trim strip

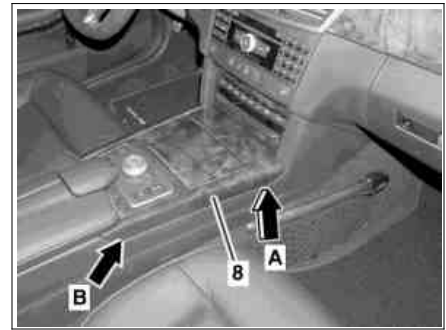

P68.20-4116-01

Shown on vehicle with code (301) ashtray package/smoker package

- 1 Stowage compartment or ashtray housing
- 2 Screw
- 3 Cup holder
- 4 Electrical connector
- R3x1 Electrical connector for cigarette lighter with front ashtray illumination (with code (301) ashtray package/smoker package)

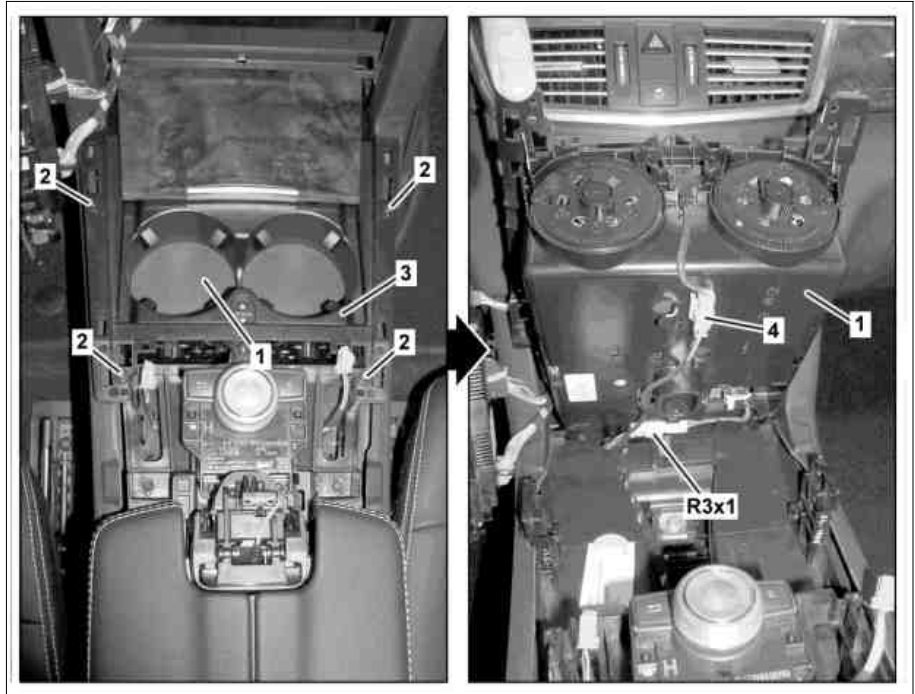

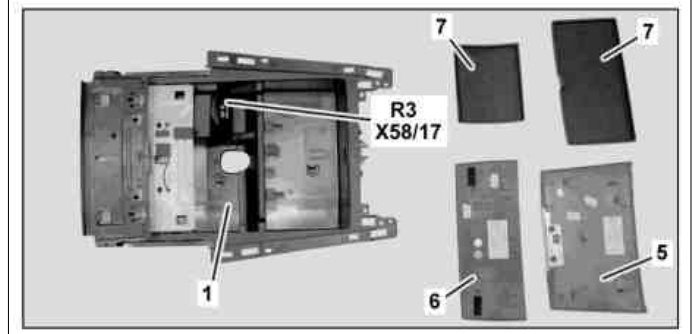
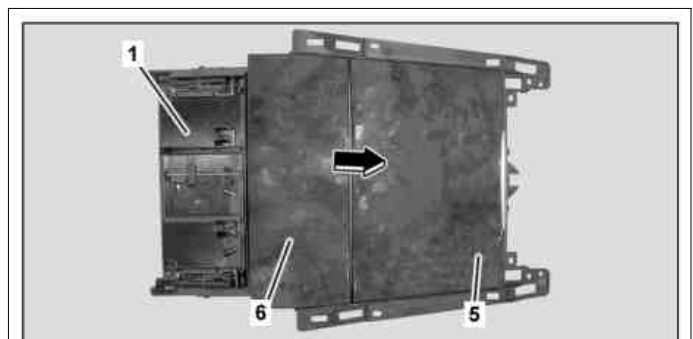

P68.20-4088-06

- 1 Stowage compartment or ashtray housing
- 5 Front cover
- 6 Rear cover
- 7 Rubber insert
- R3 Cigarette lighter with front ashtray illumination (with code (301) ashtray package/smoker package)
- X58/17 Front vehicle interior socket (without code (301) Ashtray package/smoker package)



P68.20-4089-12

1	Remove lower control panel control unit		AR54.21-P-1263EW
2	Unclip right and left trim strip (8) at front in direction of arrow (arrow A) with assembly wedge, unhook in rear area (arrow B) and remove.		*110589035900
3	Remove bolts (2)		
4	Lift stowage compartment or ashtray housing (1), disconnect electrical connector on cigarette lighter with front ashtray illumination (R3x1) as well as electrical connector (4) and remove stowage compartment or ashtray housing (1).		
5	Remove cup holder (3) and rubber inserts (7)	 On vehicles with code (301) ashtray package/smoker package, an ashtray is located instead of the rear rubber insert (7).	
6	Remove cigarette lighter with front ashtray illumination (R3) or front vehicle interior socket (X58/17)		AR54.10-P-0030EW
7	Completely close cover on stowage compartment or ashtray housing (1) and unclip front cover (5) in direction of arrow and remove.		
8	Unclip rear cover (6) in direction of arrow and remove		
9	Install in the reverse order		

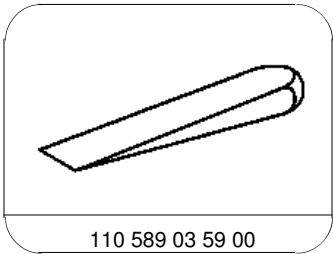

110 589 03 59 00

Mounting wedge