

110 589 03 59 00

Mounting wedge

- 1 Unclip automatic air conditioning control and operating unit (N22/7) (arrows B) and remove from operating and control unit trim part (10).
- 2 Clip automatic air conditioning control and operating unit (N22/7) into new operating and control unit trim part (10) (arrows B).

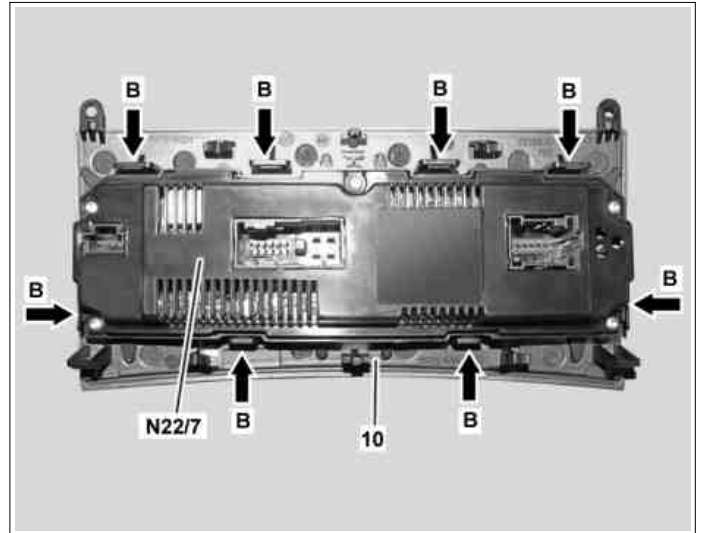

P68.30-3484-11

Shown on vehicle with code (279) Electronic drive selection stage

- 3 Unclip left center console trim part (8) and right center console trim part (13) (arrows C) and remove upward.

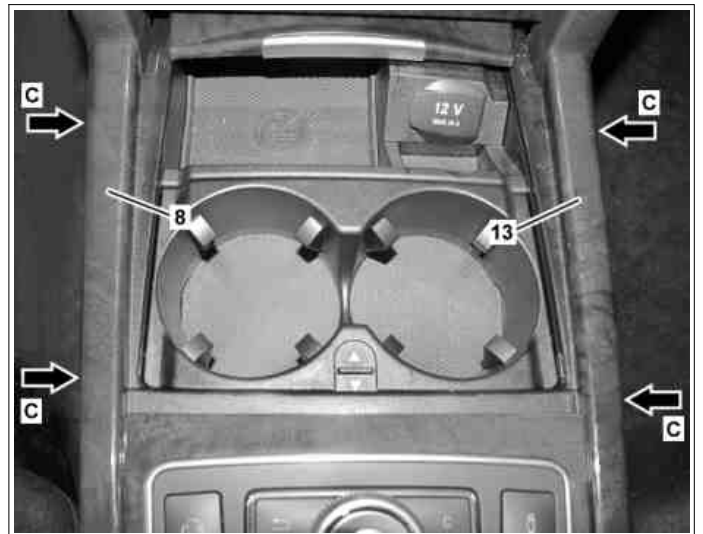

P68.30-3485-11

i Steps 4 to 18 only on vehicle with code (279) Electronic gear selector.

4 Unclip rear stowage compartment trim part (12) and remove.

i For this purpose open stowage compartment half way and press rear stowage compartment trim part (12) downward, simultaneously pulling toward rear.

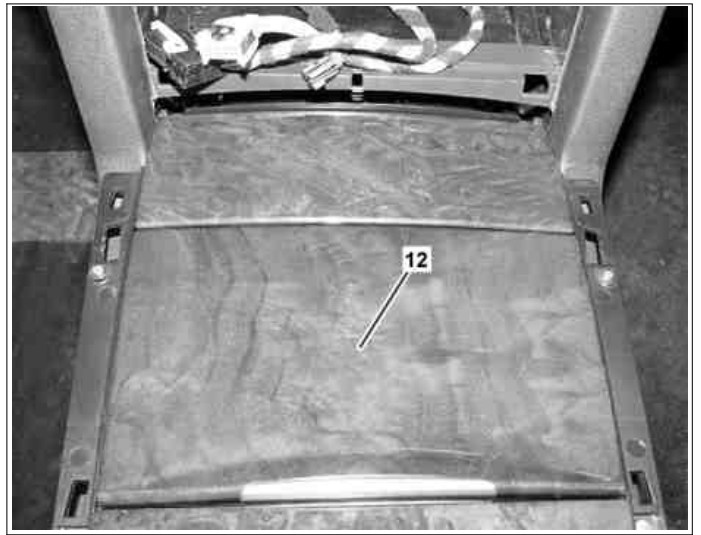

P68.30-3486-11

5 Unclip front stowage compartment trim part (11) and remove.

i For this purpose slightly open stowage compartment (16) and press front stowage compartment trim part (11) downward, simultaneously pulling toward rear.

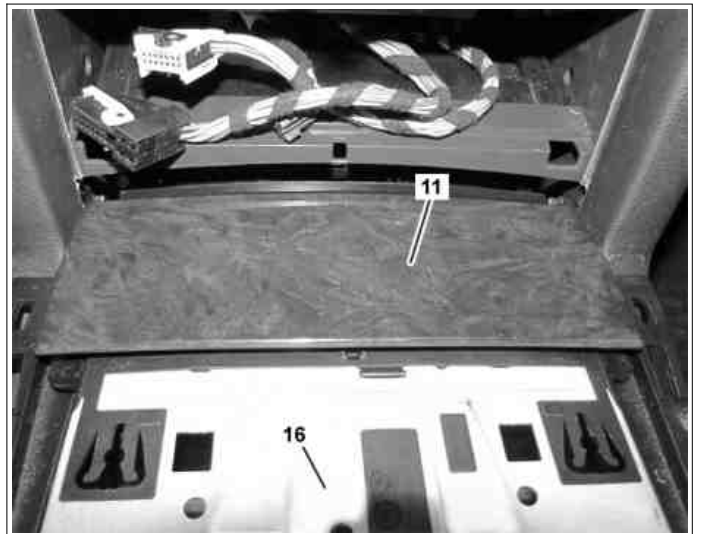

P68.30-3487-11

6 Completely open stowage compartment.

7 Unclip center middle console trim part (9) at front

i  Position assembly wedge (17) on right and left at center middle console trim part (9)

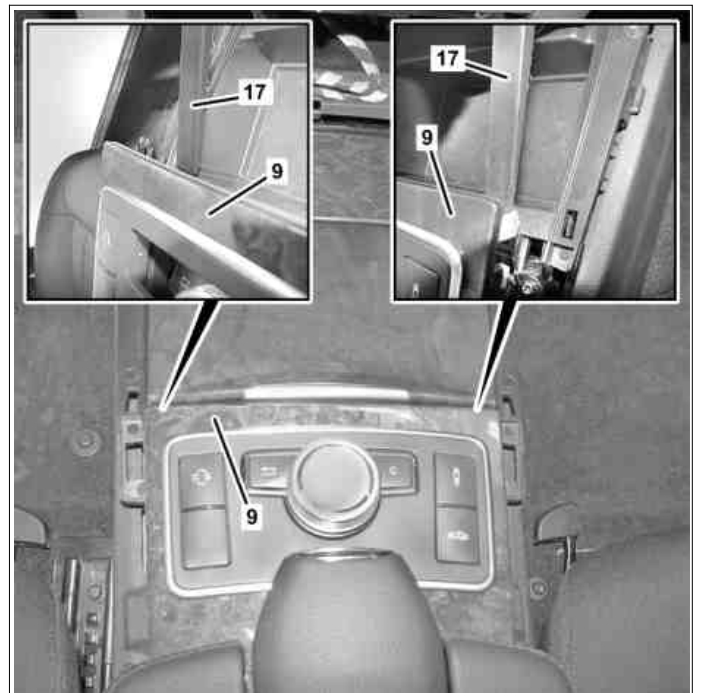

P68.30-3488-12

- 8 Remove center middle console trim part (9) toward front and fold down upward
- 9 Disconnect electrical connectors (18 and 19).
- 10 Remove center middle console trim part (9).



P68.30-3489-11

- 11 Unclip center middle console trim part (9) (arrows D) and remove.
- 12 Clip in new center middle console trim part (9) (arrows D).

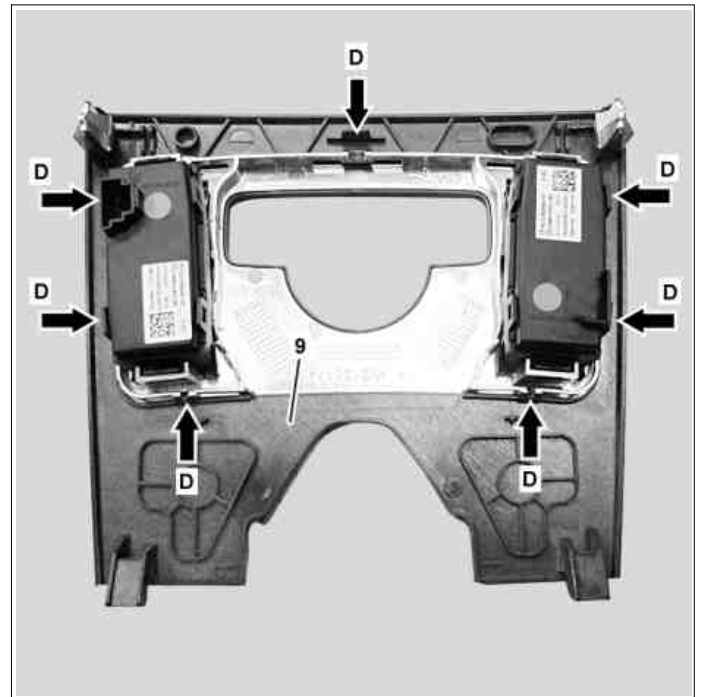

P68.30-3490-12

- 13 Insert new center middle console trim part (9) at rear.
- 14 Connect electrical connectors (18 and 19)..
- 15 Clip in new center middle console trim part (9) at front.



P68.30-3489-11

- 16 Insert new front stowage compartment trim part (11) and clip in.

i For this purpose slightly open stowage compartment (16) and press front stowage compartment trim part (11) downward and simultaneously push toward front.

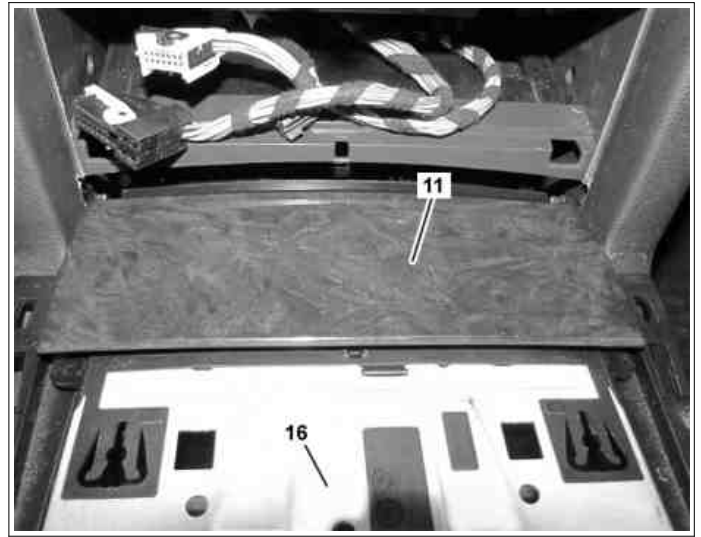

P68.30-3487-11

- 17 Insert new rear stowage compartment trim part (12) and clip in.

i For this purpose open stowage compartment half way and press rear stowage compartment trim part (12) downward, and simultaneously push toward rear.

- 18 Check whether new rear stowage compartment trim part (12) and new front stowage compartment trim part are seated correctly.

⚠ The new rear stowage compartment trim part (12) and new front stowage compartment trim part should not be offset, because the surface of the new rear stowage compartment trim part (12) and new front stowage compartment trim part can be scratched when closing the stowage compartment.

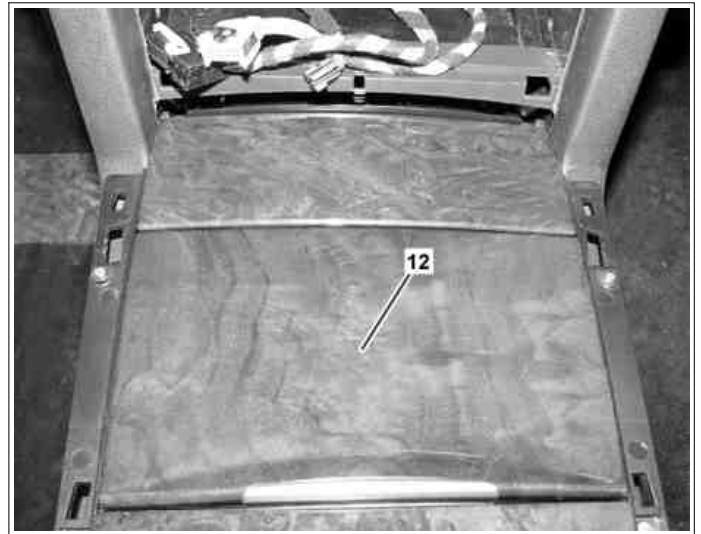

P68.30-3486-11

i Steps 19 to 28 only on vehicle without code (279) Electronic gear selector.

- 19 Unclip selector lever module trim part (15).
20 Disconnect coupling on automatic transmission mode button (S16/12).

i On vehicles with Transmission 722.6.

- 21 Loosen boot (17) from center console trim part (16) and remove center console trim part (16).
22 Unclip center console trim part (16) and remove
23 Unclip stowage compartment trim part (14) and remove.

i For this purpose open stowage compartment half way and stowage compartment trim part (14) downward, simultaneously pulling toward rear.



P68.30-3515-12

24 Insert new rear stowage compartment trim part (14) and clip in.

i For this purpose open stowage compartment half way and stowage compartment trim part (14) downward, simultaneously pushing toward front.

25 Insert center console trim part (16) and clip in.

26 Position center console trim part (16) above center console and clip in boot (17)..

27 Install coupling on automatic transmission mode button (S16/12).

i On vehicles with Transmission 722.6.

28 Insert selector lever module trim part (15) and clip in.



P68.30-3515-12

29 Insert new left center console trim part (8) and new right center console trim part (13) and clip in (arrows C).

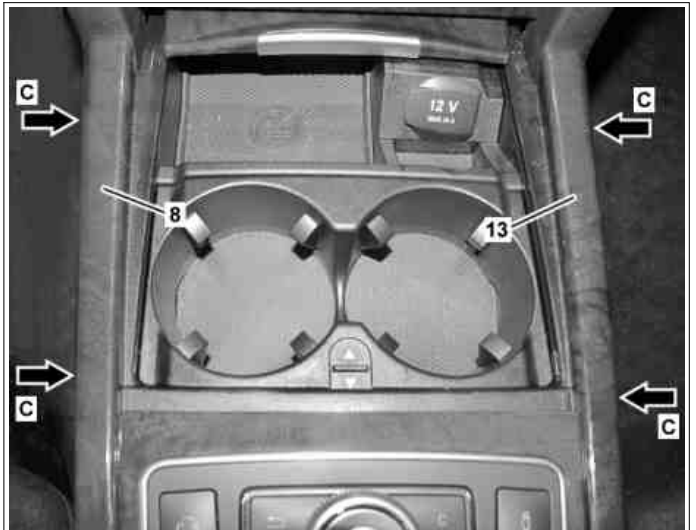

P68.30-3485-11