

MODEL 212, 218

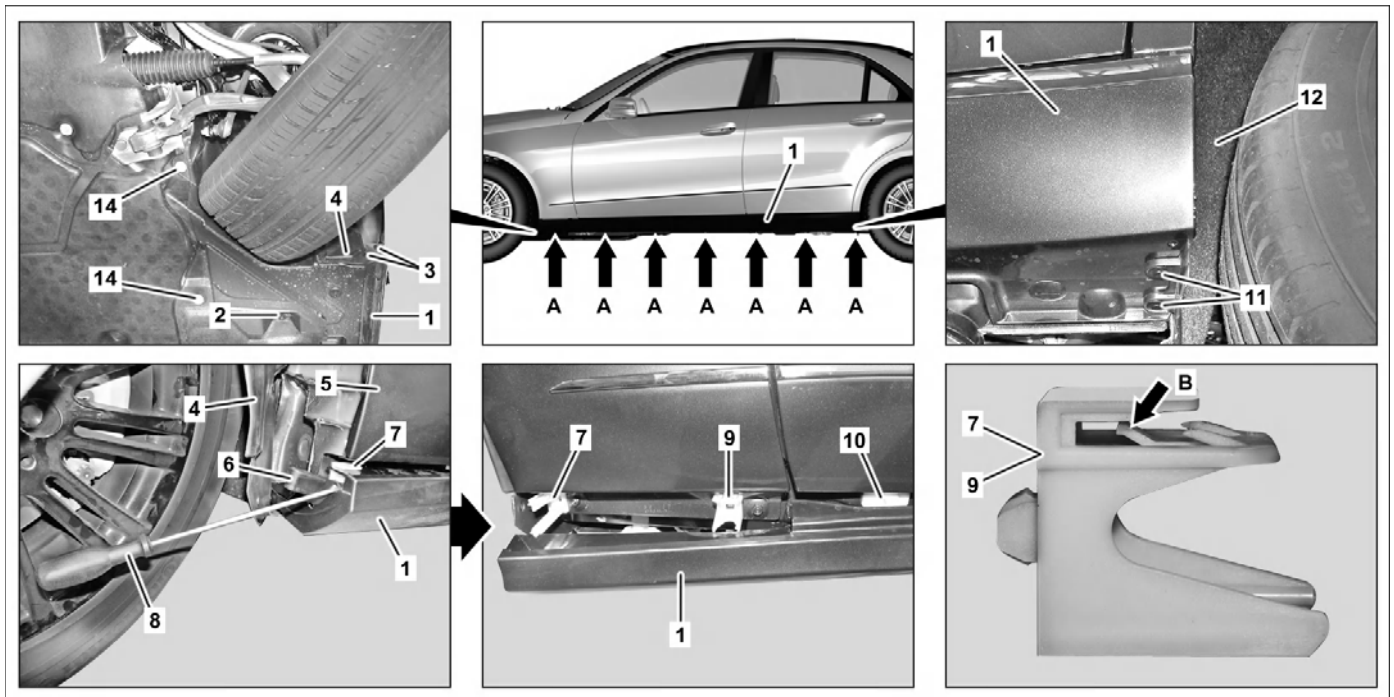

P88.80-2177-09

Shown on model 212.0

- | | | | | | |
|---|------------------------------|----|----------------|----|----------------------|
| 1 | Longitudinal member paneling | 6 | Assembly wedge | 11 | Expansion clips |
| 2 | Nut | 7 | Clip | 12 | Rear fender paneling |
| 3 | Expansion clips | 8 | Screwdriver | 14 | Screw |
| 4 | Fender liner | 9 | Clip | | |
| 5 | Front fender | 10 | Clip | | |

Shown on model 212.0

- | | |
|----|------------------------------|
| 1 | Longitudinal member paneling |
| 10 | Clips |
| 13 | Clip |

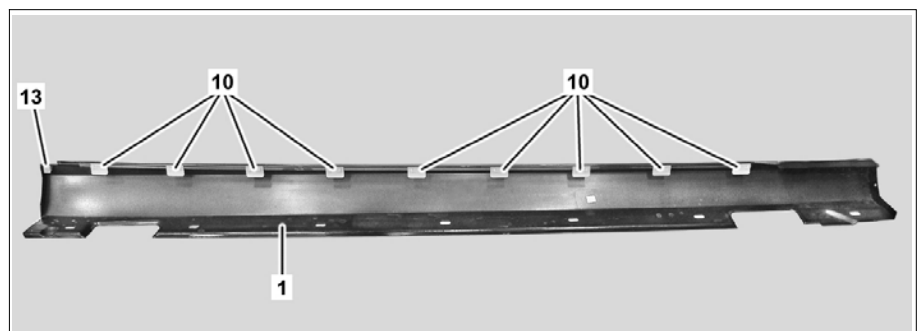



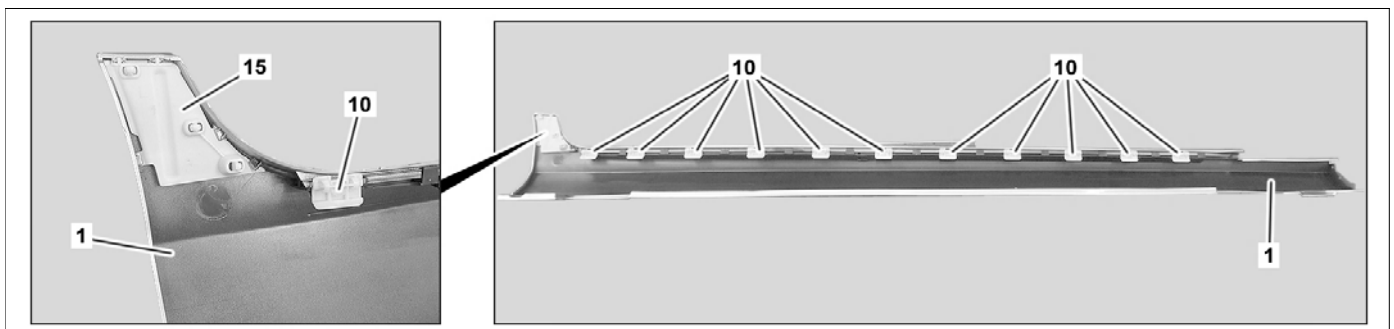











P88.80-2178-04



P88.80-2191-07

Illustrated on model 218.3

	Remove/install		
1	Loosen underfloor paneling	 Removal: Detach underfloor paneling until longitudinal member paneling (1) is accessible.	AR61.30-P-1001EL
2	Turn clips (arrows) 90° at bottom of longitudinal member panel (1) and remove clips (arrows A)		
3	Remove expansion clip (11) from rear fender paneling (12)		
4	Lift out rear fender panel (12) in area of longitudinal member panel (1) with assembly wedge (6)	 Mounting wedge	*110589035900
5	Open front door and rear door		
6	Detach fender liner (4)	MODEL 212, 218 MODEL 218  Removal: Detach fender liner (4) with assembly wedge (6) until clips (7, 9) are accessible.  Mounting wedge	AR88.10-P-1300ELX *110589035900
7	Press catch hook (arrow B) on clip (7) down with screwdriver (8) and loosen longitudinal member panel (1) from clip (7)	 Carefully press down catch hook (arrow B). Danger of breakage.  Installation: Replace damaged clip (7)	
8	Position assembly wedge (6) as spacer between longitudinal member and longitudinal member panel (1)	 Mounting wedge	*110589035900
9	Press catch hook (arrow B) on clip (9) down with screwdriver (8) and loosen longitudinal member panel (1) from clip (9)	 Carefully press down catch hook (arrow B). Danger of breakage.  Installation: Replace damaged clip (9).	
10	Unclip longitudinal member panel (1) from clips (10) on longitudinal member starting at front	 Extraction hook	*140589023300
11.1	Unclip longitudinal member panel (1) from rear fender in area of clips (13) with assembly wedge (6)	MODEL 212.0  Mounting wedge	*110589035900
11.2	Unclip longitudinal member panel (1) from rear fender in area of clips (15) with assembly wedge (6)	MODEL 218  Mounting wedge	*110589035900
12	Remove longitudinal member paneling (1)	 Replace damaged clip (13) and clip (15).	
13	Transfer cover on underfloor strut from old longitudinal member panel (1)	MODEL 212.2 When replacing longitudinal member paneling (1).	
14	Install in the reverse order		

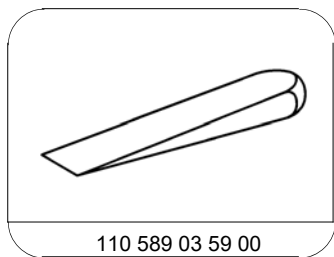

Mounting wedge

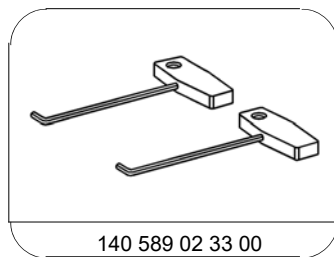

Extraction hook