

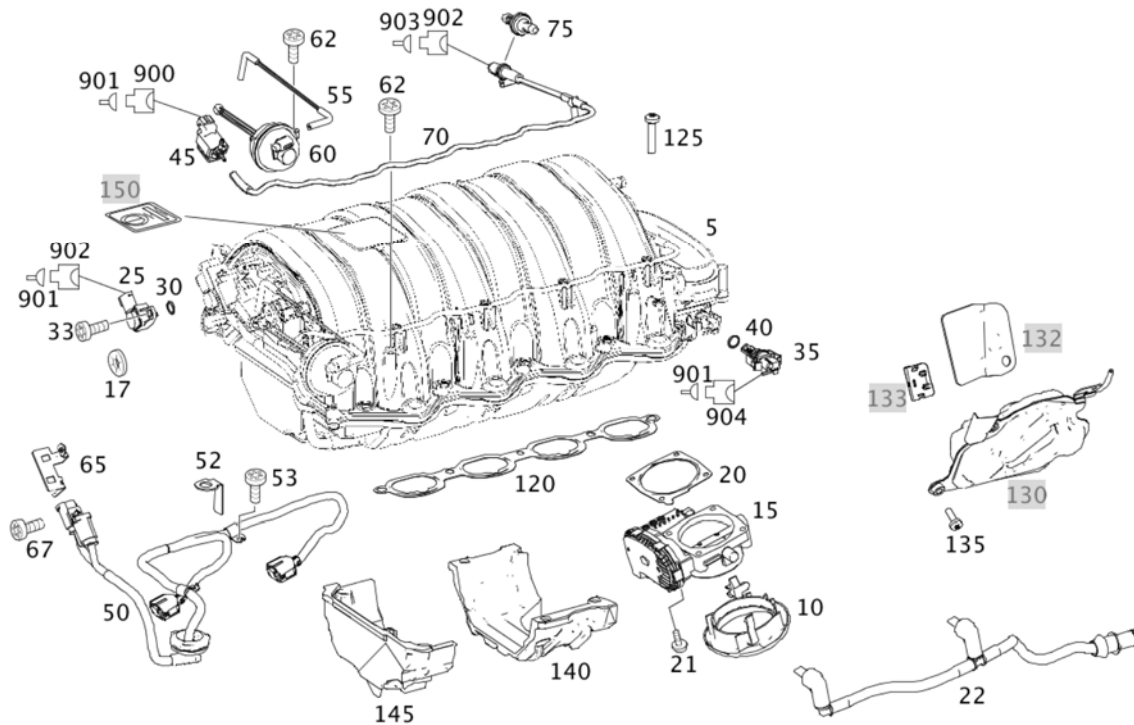









- Parts list -















Mode	BM mode	Catalog	D02
VIN/mod. des.	WDD2120771A149182	Major assembly	Chassis
VIN	WDDHF7HB5AA149182	Major assy. mod. des.	C212077
Assortment class	PC	Group	14 INTAKE AND EXHAUST MANIFOLDS
Market		Sub-group	030 INTAKE MANIFOLD
BM overview	E 63 AMG		











Copyright 2020-01-15 Daimler AG

Image ID: drawing_B14030000388

Item	Part number	Designation/additional information	Qty
5	A 156 141 08 01	INTAKE MANIFOLD  Code: -(F204+(923/P98));  [002936] FOR MODEL SERIES 164/251 TO IDENT 60 000591 ALSO ORDER A 156 010 02 70  Fault location 14002	1
5	A 156 141 08 01 	INTAKE MANIFOLD	1
10	A 156 141 02 08 	* FITTING ELECTRONIC GAS ACTUATOR TO INTAKE MANIFOLD	2
15	A 156 141 02 25 	* SLIDE VALVE ELECTRONIC GAS ACTUATOR TO INTAKE MANIFOLD  Code: F164/F251/F230/F209/F211/F219/F216/F221 /F204/F207/F212;  Plant information	2
17	A 000 994 33 11 	* PIN LOCK ELECTRONIC GAS ACTUATOR TO INTAKE MANIFOLD	9
20	A 156 141 02 80 	* GASKET ELECTRONIC GAS ACTUATOR TO INTAKE MANIFOLD	2
21	A 009 990 28 04 	* CAP BOLT WITH SOCKET	8
22	A 156 018 05 12 	* BREATHER PIPE ELECTRONIC GAS ACTUATOR TO INTAKE MANIFOLD	1
25	A 005 153 50 28   	* PRESSURE SENSOR AT INTAKE MANIFOLD  Fault location 09159	1
30	A 027 997 27 48 	** SEALING RING	1
33	A 009 990 30 04 	* CAP BOLT WITH SOCKET SENDER UNIT TO INTAKE MANIFOLD	2
35	A 000 542 28 18 	* TEMPERATURE SENSOR INTAKE AIR Replaced by: A 651 153 00 28	1

Item	Part number	Designation/additional information	Qty
35	A 651 153 00 28 	* TEMPERATURE SENSOR INTAKE AIR Replaces: A0005422818	1
40	A 601 997 04 48 	** SEALING RING 11X2	1
45	A 002 540 18 97 	* VALVE AT INTAKE MANIFOLD  Fault location 54596	1
50	A 156 150 12 33 	* ELECTRICAL WIRING HARNESS AT INTAKE MANIFOLD Replaced by: A 156 150 43 33	1
50	A 156 150 43 33 	* ELECTRICAL LINE AT INTAKE MANIFOLD Replaces: A1561501233	1
52	A 000 994 08 01 	* SECURING CLIP	2
53	A 009 990 30 04 	* CAP BOLT WITH SOCKET LINE MOUNTING	2
55	A 156 140 02 64 	* AIR LINE BETWEEN ELECTRIC CHANGE-OVER VALVE AND VACUUM BOX	1
60	A 156 141 02 69 	* VACUUM CELL	1
62	A 009 990 29 04 	* CAP BOLT WITH SOCKET VACUUM BOX	2
62	A 009 990 30 04 	* CAP BOLT WITH SOCKET VACUUM CELL ON INTAKE MANIFOLD	13
65	A 156 141 07 40 	* BRACKET WIRING HARNESS TO INTAKE PIPE  [402] NO LONGER AVAILABLE	1
67	A 009 990 30 04 	* CAP BOLT WITH SOCKET CABLE HARNESS BRACKET	2

Item	Part number	Designation/additional information	Qty
70	A 156 140 03 64 	AIR LINE ELECTRIC CHANGE-OVER VALVE  Code: F164/F251/F230/F209/F211/F219/F216/F221 /F204/F207/F212;	1
75	A 156 141 02 58 	* VALVE AT INTAKE MANIFOLD	1
120	A 156 141 03 80	METAL SEAL LEFT CYLINDER HEAD Replaced by: A 156 141 04 80  Fault location 14A06	1
120	A 156 141 04 80	METAL SEAL LEFT CYLINDER HEAD Replaced by: A 159 141 05 80 Replaces: A1561410380  Fault location 14A06	1
120	A 159 141 05 80	METAL SEAL LEFT CYLINDER HEAD Replaces: A1561410480 Replaces: A1561410380  Fault location 14A06	1
120	A 156 141 03 80	METAL SEAL RIGHT CYLINDER HEAD Replaced by: A 156 141 04 80  Fault location 14A06	1
120	A 156 141 04 80	METAL SEAL RIGHT CYLINDER HEAD Replaced by: A 159 141 05 80 Replaces: A1561410380  Fault location 14A06	1
120	A 159 141 05 80	METAL SEAL RIGHT CYLINDER HEAD Replaces: A1561410480 Replaces: A1561410380  Fault location 14A06	1
125	N 000000 001153	HEXALOBULAR BOLT INTAKE MANIFOLD TO CYLINDER HEAD; M8X40 Replaced by: A 004 990 53 12	10
125	A 004 990 53 12	HEXALOBULAR BOLT INTAKE MANIFOLD TO CYLINDER HEAD; M8X40 Replaces: N000000001153	10

Item	Part number	Designation/additional information	Qty
135	N 000000 001145	HEXALOBULAR BOLT AT CYLINDER CRANKCASE; M6X12	1
135	N 000000 001428	HEXALOBULAR BOLT AT CYLINDER CRANKCASE; M8X25	1
140	A 156 226 04 85	DAMPING SUCTION CONNECTION	1
145	A 156 226 05 85	DAMPING SUCTION CONNECTION	1
900	A 210 540 20 81	RECEPTACLE HOUSING AIR PUMP Y32; 2-PIN MQS	1
901	A 000 545 69 80	SEAL 1.4-1.9 MM MQS/MCP1.2	NB
901	A 000 545 68 80	SEAL YELLOW; 0.9-1.4 MM MQS/MCP1.2	NB
902	A 210 540 21 81	CLUTCH, MECHANICAL PESSURE SENSOR ON INTAKE MANIFOLD B28; 3-PIN MQS	1
903	A 009 545 81 26	CONTACT SOCKET 0.75-1.0 MM2 SLK2.8	NB
903	A 000 545 28 39	CORE BUNDLE SEALING LIGHT BLUE; 0.5-1.0 MM JPT/MCP2.8	NB
904	A 210 540 20 81	RECEPTACLE HOUSING INTAKE AIR TEMPERATURE SENSOR B17; 2-PIN MQS	1