

- Parts list -

Mode	BM mode	Catalog	D04
VIN/mod. des.	WDD2120881A625191	Major assembly	Chassis
VIN	WDDHF8JB5CA625191	Major assy. mod. des.	C212088
Assortment class	PC	Group	27 AUTOMATIC TRANSMISSION
Market		Sub-group	165 TRANSFER CASE INTERIOR PARTS
BM overview	E 350 4MATIC		

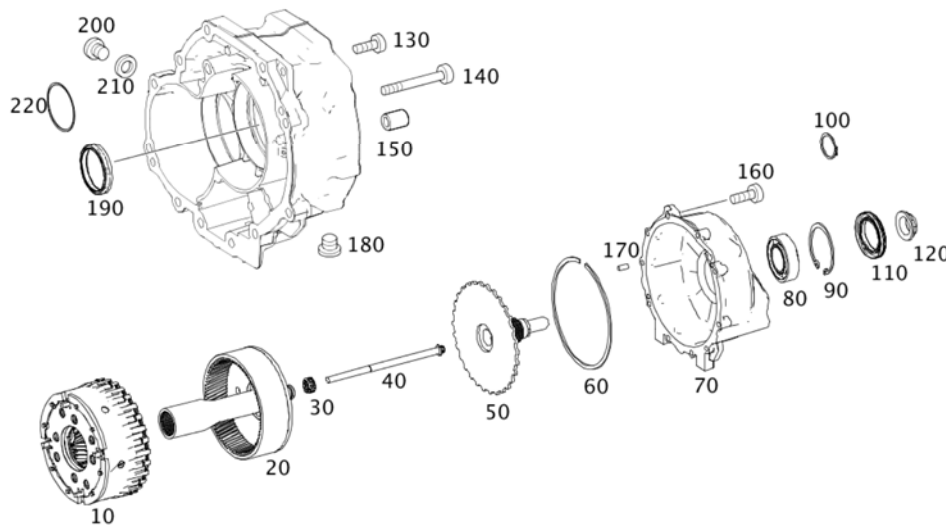



























Image ID: drawing_B2716500005



Item	Part number	Designation/additional information	Qty
10	A 221 270 00 43	* PLANETARY CARRIER Replaced by: A 221 270 18 43 Code: G960/G961/G962/G963/G964/G965/G966/G967; [414] THE OLD PART MUST NO LONGER BE INSTALLED	1
10	A 221 270 18 43	* PLANET CARRIER Replaced by: A 221 270 86 04 Replaces: A2212700043 Code: G960/G961/G962/G963/G964/G965/G966/G967 /G968/G969/G985/G986;	1
10	A 221 270 86 04	* PLANET CARRIER Replaces: A2212701843 Replaces: A2212700043 Code: G960/G961/G962/G963/G964/G965/G966/G967 /G968/G969/G985/G986; Fault location 28231	1
20	A 221 270 00 45	* RING GEAR Replaced by: A 221 270 03 45 Code: G960/G961/G972/G962/G963/G964/G965/G966 /G967/G968/G969/G985/G986;	1

Item	Part number	Designation/additional information	Qty
20	A 221 270 03 45	<p>* RING GEAR Replaces: A2212700045  Code: G960/G961/G962/G963/G964/G965/G966/G967 /G968/G969/G972/G985/G986;  Fault location 28010</p>	1
30	A 221 981 00 18	<p>* NEEDLE BEARING  Code: G960/G961/G962/G963/G964/G965/G966/G967 /G968/G969/G971/G972/G973/G985/G986;  Fault location 28203</p>	2
40	N 000000 003937	<p>* HEXALOBULAR BOLT Replaced by: N 000000 008248  Code: G960/G961/G962/G963/G964/G965/G966/G967 /G968/G969/G985/G986;  [414] THE OLD PART MUST NO LONGER BE INSTALLED</p>	1
40	N 000000 008248	<p>* HEXALOBULAR BOLT M8X165 Replaces: N000000003937  Code: G960/G961/G962/G963/G964/G965/G966/G967 /G968/G969/G985/G986;</p>	1
50	A 221 270 03 26	<p>* SHAFT OUTPUT SHAFT  Code: G960/G961/G962/G963/G964/G965/G966/G967 /G968/G969/G985/G986;  Fault location 28219</p>	1
60	A 001 994 09 40	<p>* SNAP RING OUTPUT SHAFT  Code: G960/G961/G962/G963/G964/G965/G966/G967 /G968/G969/G971/G972/G973/G985/G986;  Plant information  Fault location 28564</p>	1
70	A 221 274 04 10	<p>* COVER FOR HOUSING TRANSMISSION CASE Replaced by: A 221 274 08 10  Code: G960/G961/G962/G963/G964/G965/G966/G967;</p>	1
70	A 221 274 08 10	<p>* COVER FOR HOUSING Replaced by: A 222 274 00 10 Replaces: A2212740410  Code: G960/G961/G962/G963/G964/G965/G966/G967;  Fault location 28116</p>	1
70	A 222 274 00 10	<p>* COVER FOR HOUSING Replaces: A2212740810 Replaces: A2212740410  Code: G960/G961/G962/G963/G964/G965/G966/G967 /G968/G969/G985/G986;  Fault location 28116</p>	1
80	A 140 981 01 25	<p>* BALL BEARING  Code: G960/G961/G962/G963/G964/G965/G966/G967 /G968/G969/G985/G986;  Fault location 28520</p>	1
90	A 001 994 08 40	<p>* SNAP RING  Code: G960/G961/G962/G963/G964/G965/G966/G967 /G968/G969/G971/G972/G973/G985/G986;  Fault location 28223</p>	1
100	N 000471 032000	<p>* RETAINING RING DRIVE  Code: G960/G961/G962/G963/G964/G965/G966/G967 /G968/G969/G971;</p>	1
110	A 015 997 12 46	<p>* RADIAL SHAFT SEALING RING  Code: G960/G961/G962/G963/G964/G965/G966/G967 /G968/G969/G971/G972/G973/G985/G986;  Fault location 28111</p>	1

Copyright 2020-05-27 Daimler AG

Item	Part number	Designation/additional information	Qty
120	A 140 990 11 50	* NUT M26X1.5  Code: G960/G961/G962/G963/G964/G965/G966/G967 /G968/G969/G971/G972/G973/G985/G986;  Fault location 28523	1
130	N 000000 002191	* HEXALOBULAR BOLT COVER TO TRANSMISSION CASE; M8X35  Code: G960/G961/G962/G963/G964/G965/G966/G967 /G968/G969/G971/G972/G973/G985/G986;	9
140	N 000000 001433	* HEXALOBULAR BOLT COVER TO TRANSMISSION CASE; M8X80  Code: G960/G961/G962/G963/G964/G965/G966/G967 /G968/G969/G971/G972/G973/G985/G986;	2
150	N 000000 003654	* CYLINDER PIN COVER TO TRANSMISSION CASE; 8M6X24-A1  Code: G960/G961/G962/G963/G964/G965/G966/G967 /G968/G969/G971/G972/G973/G985/G986;	2
160	N 000000 002439	* HEXALOBULAR BOLT M6X25  Code: G960/G961/G962/G963/G964/G965/G966/G967 /G968/G969/G971/G972/G973/G985/G986;	10
170	N 000000 003653	* CYLINDER PIN 6M6X14-A1  Code: G960/G961/G962/G963/G964/G965/G966/G967 /G968/G969/G971/G972/G973/G985/G986;	2
180	A 000 990 83 00	* HEXAGON HEAD BOLT OIL DRAIN  Code: G960/G961/G962/G963/G964/G965/G966/G967 /G968/G969/G971/G972/G973/G985/G986;  Fault location 28381	1
190	A 013 997 72 46	* SEALING RING FRONT AXLE  Code: G960/G961/G972/G962/G963/G964/G965/G966 /G967/G968/G969/G971/G973/G985/G986;  Fault location 28275	1
200	N 000908 012009	* SCREW PLUG OIL REFILLING  Code: G960/G961/G962/G963/G964/G965/G966/G967 /G968/G969/G971/G972/G973/G985/G986;	1
210	N 007603 012102	* SEALING RING OIL REFILLING  Code: G960/G961/G962/G963/G964/G965/G966/G967 /G968/G969/G971/G972/G973/G985/G986;	1
220	A 003 990 26 82	* WINDOW SHIM; 1.4 MM  Code: G960/G961/G972/G962/G963/G964/G965/G966 /G967/G985/G986;	NB
220	A 003 990 27 82	* WINDOW SHIM; 1.5 MM  Code: G960/G961/G972/G962/G963/G964/G965/G966 /G967/G985/G986;	NB
220	A 003 990 28 82	* WINDOW SHIM; 1.6 MM  Code: G960/G961/G972/G962/G963/G964/G965/G966 /G967/G985/G986;	NB
220	A 003 990 29 82	* WINDOW SHIM; 1.7 MM  Code: G960/G961/G972/G962/G963/G964/G965/G966 /G967/G985/G986;	NB
220	A 003 990 30 82	* WINDOW SHIM; 1.8 MM  Code: G960/G961/G972/G962/G963/G964/G965/G966 /G967/G985/G986;	NB

Copyright 2020-05-27 Daimler AG

Item	Part number	Designation/additional information	Qty
220	A 003 990 31 82	* WINDOW SHIM; 1.9 MM  Code: G960/G961/G972/G962/G963/G964/G965/G966 /G967/G985/G986;	NB
220	A 003 990 32 82	* WINDOW SHIM; 2.0 MM  Code: G960/G961/G972/G962/G963/G964/G965/G966 /G967/G985/G986;	NB
220	A 003 990 33 82	* WINDOW SHIM; 2.1 MM  Code: G960/G961/G972/G962/G963/G964/G965/G966 /G967/G985/G986;	NB