

MODEL 463.346
up to model year 2013
/model refinement package 2012

MODEL 463.222/270/271/303/340/341
As of model year 2010





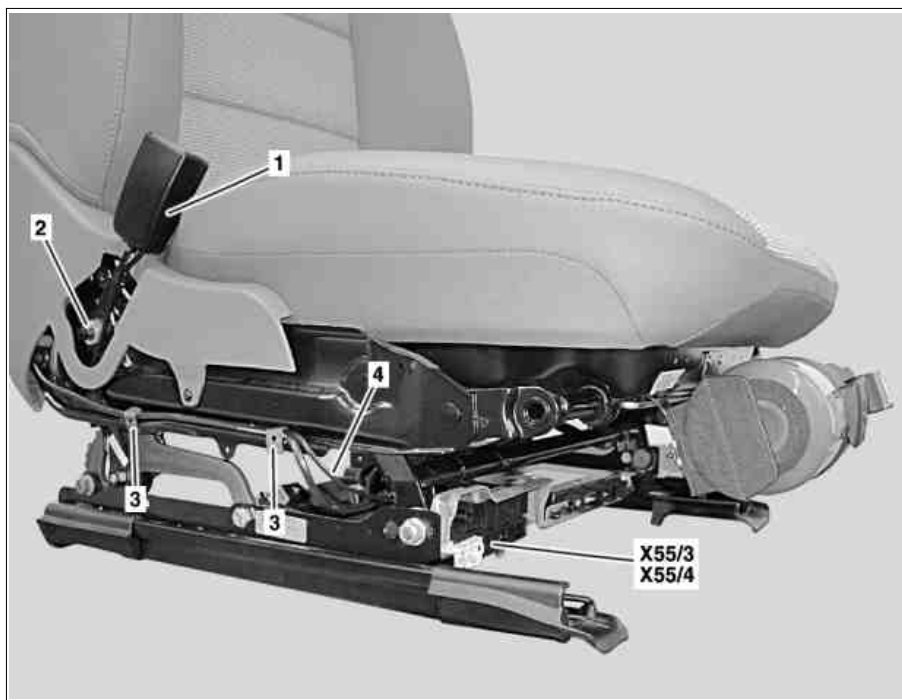

MODEL 463.202/236/237
as of model year 2010
up to model year 2013, /model refinement package 2012

Shown on model 204.052, left front seat

- 1 Seat belt buckle
2 Nut
3 Clip
4 Electrical wiring harness
X55/3 Driver seat connector block
X55/4 Front passenger seat connector block



P91.40-2740-06

 	Remove/install		
1	Remove left or right front seat	MODEL 204, 207, 212, 218	AR91.10-P-1000CW
		MODEL 463.202/222/303/306/336/340 MODEL 463.236/237/270/271/341/346	AR91.10-P-1000GM AR91.10-P-1000GN
2	Unclip driver seat connector block (X55/3) or front passenger seat connector block (X55/4) from bracket		
3	Unclip driver seat belt buckle restraint system switch electrical connector or front passenger seat belt buckle restraint system switch electrical connector from driver seat connector block (X55/3) or front passenger seat connector block (X55/4) using suitable tool	 Carefully unclip electrical connector. Risk of breakage to the electrical connector.	
4	Loosen clamps (3) on seat frame		
5	Expose electric wiring harness (4)		
6	Detach seat belt buckle (1)	 MODEL 204, 207  MODEL 212, 218  MODEL 463	*BA91.40-P-1004-01P *BA91.40-P-1006-01Q *BA91.40-P-1003-01C
7	Install in the reverse order		

 Seat belts/emergency tensioning retractors

Number	Designation	MODEL 212.0	MODEL 212.1
--------	-------------	-------------	-------------

Nm Seat belts/emergency tensioning retractors

Number	Designation		MODEL 212.2	MODEL 218.3
BA91.40-P-1006-01Q	Nut, front seat belt buckle	Nm	35	35

Nm Seat belts/emergency tensioning retractors

Number	Designation		MODEL 218.9
BA91.40-P-1006-01Q	Nut, front seat belt buckle	Nm	35

Nm Seat belts/emergency tensioning retractors

Number	Designation		MODEL 204.0	MODEL 204.2
BA91.40-P-1004-01P	Nut at front seat belt buckle	Nm	32	32

Nm Seat belts/emergency tensioning retractors

Number	Designation		MODEL 204.3	MODEL 204.9
BA91.40-P-1004-01P	Nut at front seat belt buckle	Nm	35	32

Nm Seat belts/emergency tensioning retractors

Number	Designation		MODEL 207
BA91.40-P-1004-01P	Nut at front seat belt buckle	Nm	35

Nm Seat belts/emergency tensioning retractors

Number	Designation		MODEL 463
BA91.40-P-1003-01C	Bolt to front seat belt buckle	Nm	35