

- Parts list -

Vehicle	WDDKJ6FB9GF346255 (D48)	E 400 BLUE EFFICIENCY	
Color	040 - undefined	Equipment	264 -
FIN: WDD2073651F346255		Assortment class	PC
Group	62 COWL,FRONT PANEL	Sub-group	060 FRONT STIFFENING AND RADIATOR SUPPORT

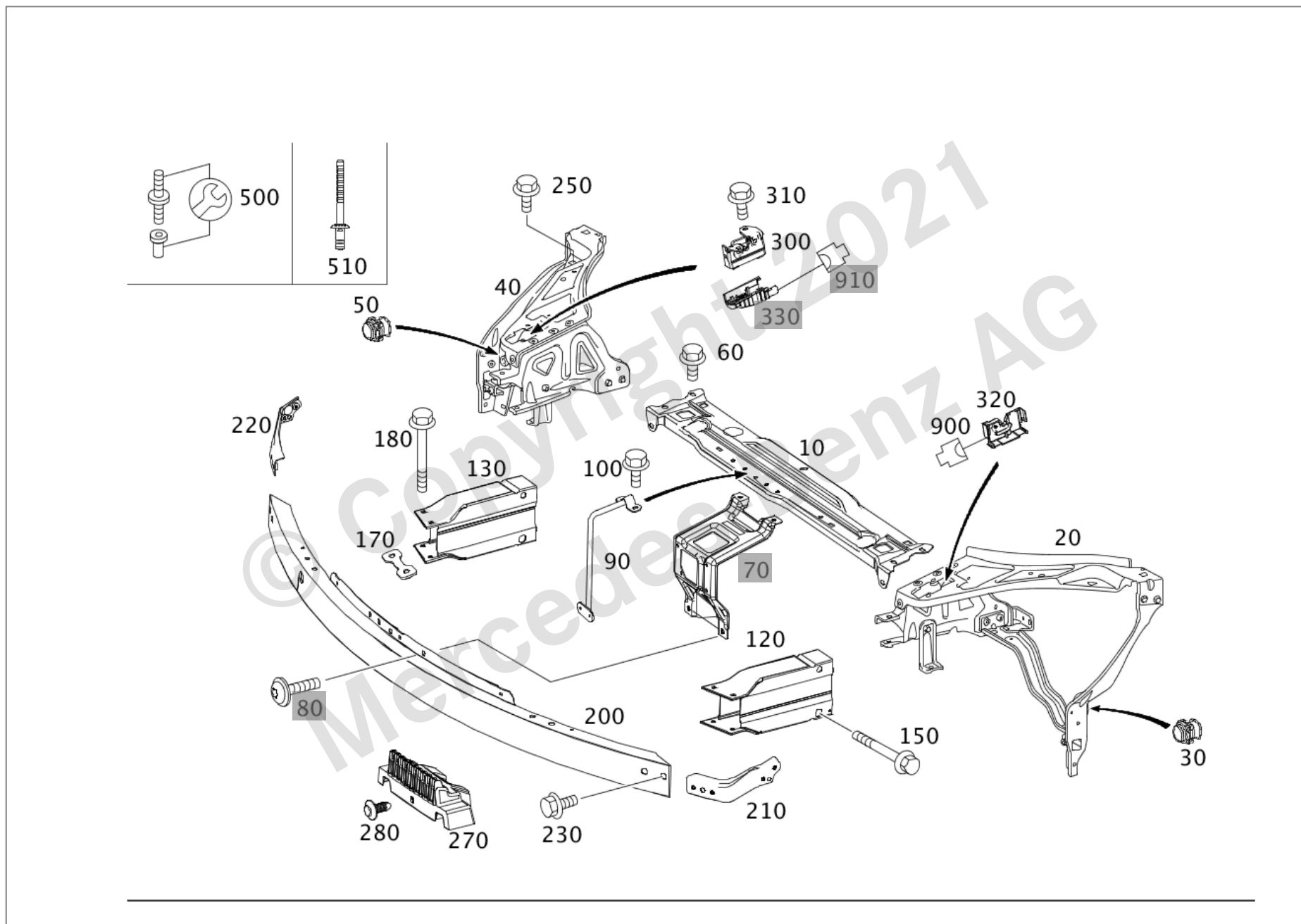















Image ID: drawing_B62060000281

Item	Part number	Designation/additional information	Qty
10	A 207 620 02 72	STIFFENER FRONT CENTER Code: M278/M276+M002;	1
20	A 207 620 03 91	FRAME FOR LAMP LEFT LIGHTING UNIT Fault location 62A10 Replaced by: A 207 620 19 00	1
20	A 207 620 19 00	FRAME FOR LAMP UNIT LEFT LIGHTING UNIT Fault location 62A10 Replaces: A 207 620 03 91	1
30	A 001 997 01 01	* HOLLOW SCREW LEFT [002345] NOTE SERVICE INFORMATION IN WIS	1
40	A 207 620 20 00	FRAME FOR LAMP UNIT RIGHT LIGHTING UNIT Fault location 62N10	1
50	A 001 997 01 01	* HOLLOW SCREW RIGHT [002345] NOTE SERVICE INFORMATION IN WIS	1

Parts Information

Item	Part number	Designation/additional information	Qty
60	A 001 990 80 00	COMBI-HEXAGON HEAD BOLT FASTENING, FRAME AT REINFORCEMENT, LEFT; M6X19	8
60	A 001 990 80 00	COMBI-HEXAGON HEAD BOLT FASTENING, FRAME AT REINFORCEMENT, RIGHT; M6X19	2
90	A 207 898 01 32	BRACKET  Fault location 62070	1
100	N 000000 001475	HEXALOBULAR BOLT CLIP FASTENING; M6X12	4
120	A 207 620 07 00	ABSORBER LEFT  Fault location 62A0K	1
130	A 207 620 00 95	ABSORBER RIGHT	1
150	A 017 990 60 01	COMBI-HEXAGON HEAD BOLT ABSORBER AT LONGITUDINAL MEMBER	4
170	A 212 620 00 26	THREADED PLATE ABSORBER TO CROSSMEMBER	2
180	A 009 990 27 04	COMBI-FILLISTER HEAD SCR. ABSORBER TO CROSSMEMBER; M10X98	4
200	A 207 620 04 00	CROSSMEMBER CENTRAL  Code: 460/494;  Fault location 62021	1
210	A 207 620 01 85	STRUT LEFT	1
220	A 207 620 02 85	STRUT RIGHT	1
230	A 001 990 80 00	COMBI-HEXAGON HEAD BOLT FASTENING STRUT; M6X19	8
250	A 001 990 80 00	COMBI-HEXAGON HEAD BOLT SUPPORT TO SIDE MEMBER; M6X19	8
270	A 207 885 00 36	BRACING AT CROSS MEMBER  Code: 460/494;	1
280	A 000 990 54 92 9051 	RIVET SUPPORT MOUNT; 6 MM  Code: 460/494;	1
300	A 204 880 02 60	HOOD LOCK TO REINFORCEMENT AT LEFT AND RIGHT	2
310	N 910105 006023	HEXAGON HEAD BOLT HOOD LOCK AT REINFORCEMENT, LEFT AND RIGHT; M6X16	4
320	A 204 870 31 58	SWITCH ENGINE HOOD LATCH, DRIVER SIDE  Code: (551/B03)+-U60;  Fault location 82E09	1
320	A 204 870 44 58	SWITCH ENGINE HOOD LATCH, PASSENGER SIDE  Code: B03+-U60;  Fault location 82T09	1
500	A 000 990 12 10	TS THREADED PIN REPAIR SOLUTION FOR RUPTURED WELDED PINS	NB
510	A 000 991 76 32	BLIND RIVET REPAIR SOLUTION; 6,4 X 12MM / 1-3,5MM  [002970, 402] RIVET ONLY VALID FOR BR 222. FOR REPAIR INFORMATION, SEE WIS.	NB
900	A 203 540 04 81	SOCKET HOOD CATCH LEFT S62; 2-PIN MQS  Code: (551/B03)+-U60;	1

Item	Part number	Designation/additional information	Qty
900	A 204 440 30 33	ELECTRICAL WIRING HARNESS ENGINE HOOD CONTACT SWITCH S62/42  [409] TO BE ADAPTED DURING ASSEMBLY  Code: B03+-U60;	1