

- Parts list -

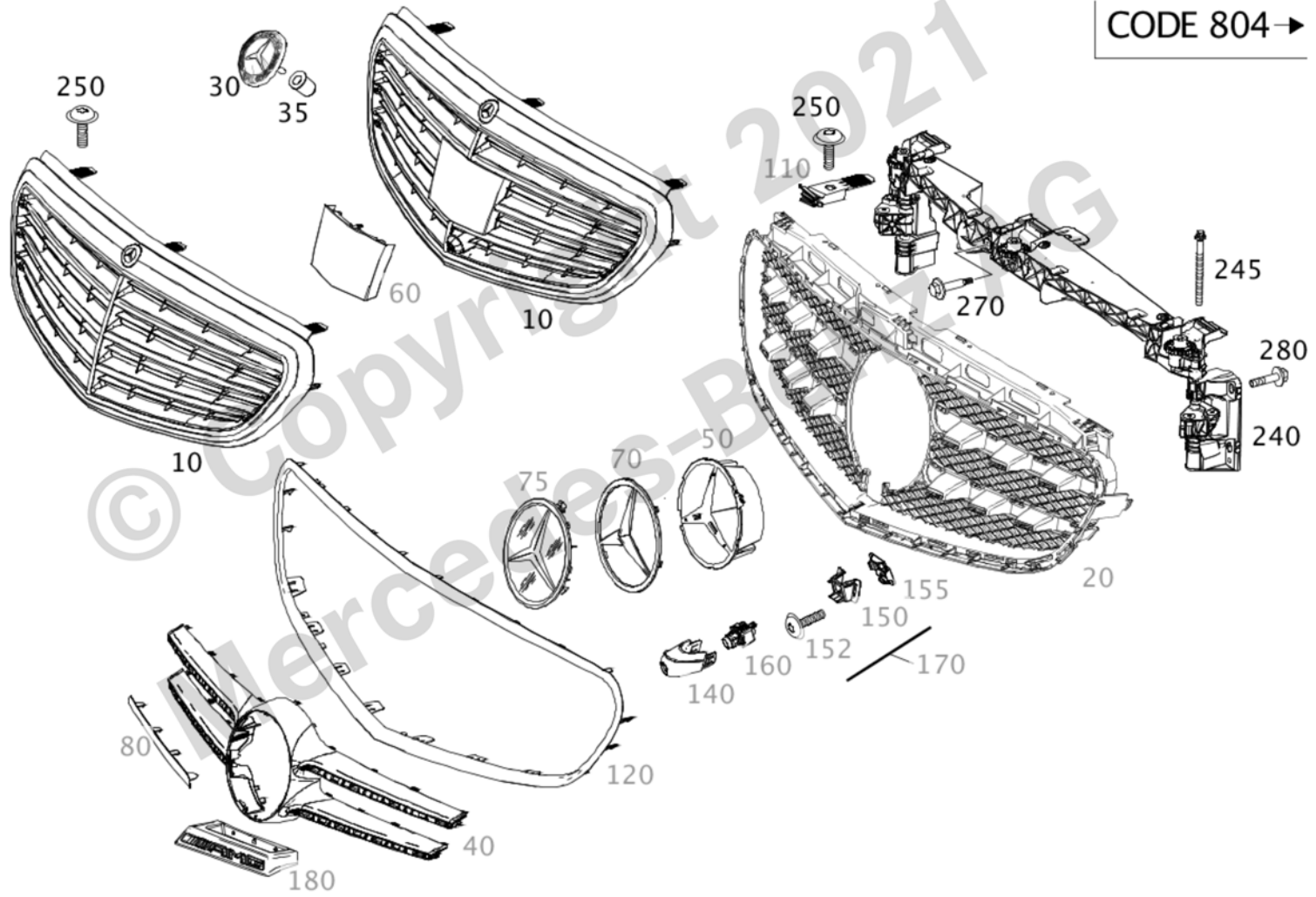











Vehicle	WDDHH3EB4FB106039 (D24)	E 200	
Color	040 - SCHWARZ - UNILACK	Equipment	111 - KUNSTLEDER - SCHWARZ / ANTHRAZIT
FIN: WDD2122341B106039		Assortment class	PC
Group	88 ATTACHMENT PARTS	Sub-group	135 RADIATOR GRILL

CODE 804 →



Parts Information

Image ID: drawing_B88135000149

Item	Part number	Designation/additional information	Qty
10	A 212 880 13 83 	RADIATOR GRILLE  Code: 953+-4U4;	1
30	A 221 817 00 16 	* COMPANY SIGN  Code: (800/801/802/803)/-(954/4U4)+-(800/801/802/803);  Fault location 88303	1
35	A 168 997 13 81 	* GROMMET  Code: (800/801/802/803)/-(954/4U4)+-(800/801/802/803);	2
240	A 212 880 14 03 	CARRIER RADIATOR GRILL  Code: -(800/801/802/803);	1
245	A 212 990 00 03 	* SCREW WITH FEATURE  Code: -(800/801/802/803);	2
250	N 000000 007095	PAN HEAD SCREW RADIATOR GRILLE SHELL TO CROSS CONNECTION; 7X30  Code: (953/954/955)+-(800/801/802/803);	3
270	A 000 990 55 23	SCREW, SPECIAL SHAPE FRONT SUPPORT; M6X33  Code: -(800/801/802/803);	1

Parts Information

Item	Part number	Designation/additional information	Qty
280	N 000000 007018	SCREW-AND-WASHER ASSEMBLY CARRIER FASTENING; M6X30 ☒ Code: -(800/801/802/803); Replaced by: N 000000 000281 +1 N 000000 003260 WASHER	5
280	N 000000 000281	HEXALOBULAR BOLT CARRIER FASTENING; M6X30 Replaces: N 000000 007018 +1 N 000000 003260 WASHER	5