

MODEL 212
 as of model year 2014
 without CODE 772 (AMG bodystyling)
 without CODE 954 (AVANTGARDE)

- 2 Radiator grille
- 3 Screw
- 4 Catch lug

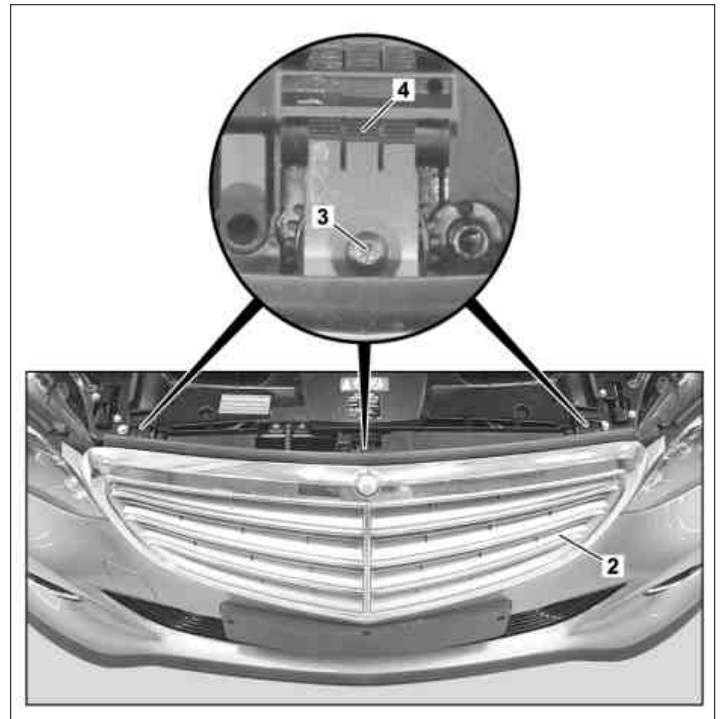

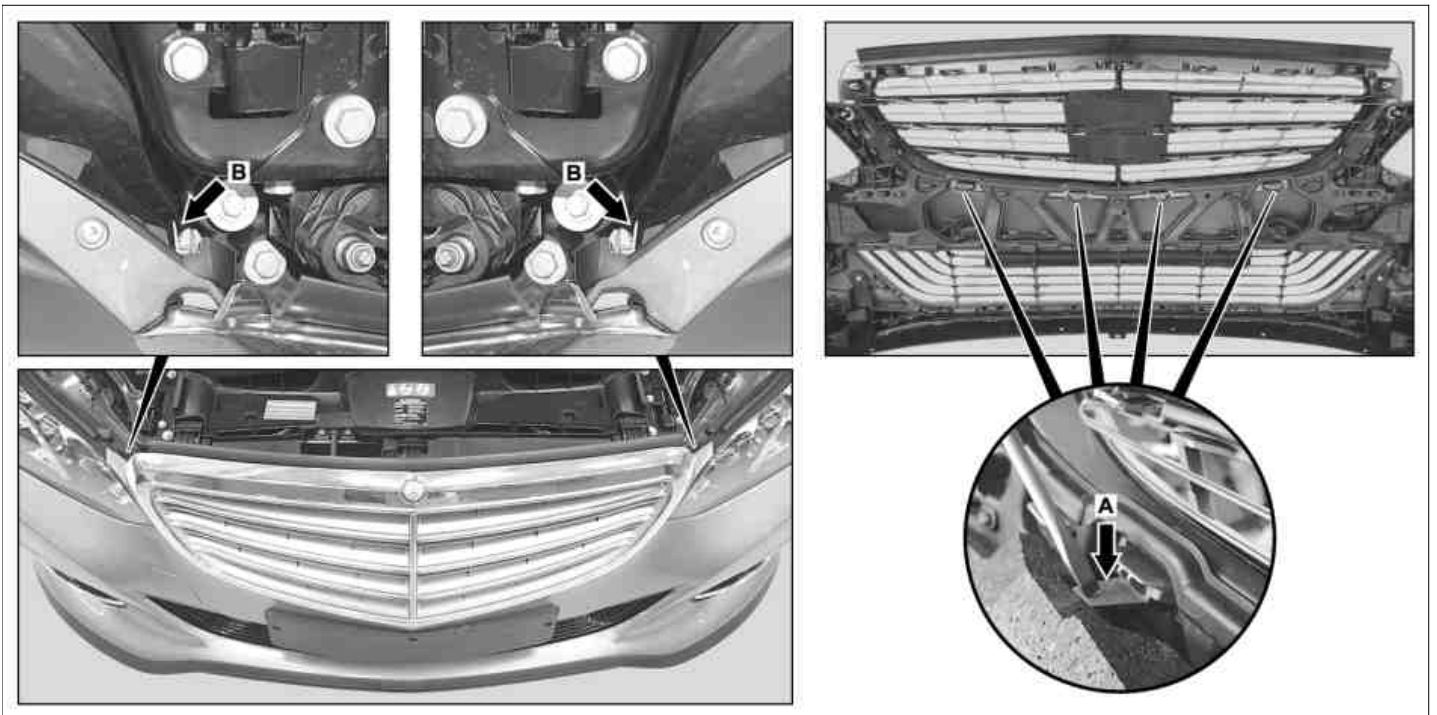



P88.40-3085-12



P88.40-3086-09

	Remove/install		
1	Open engine hood		AR88.40-P-1000EW

2	Remove screws/bolts (3)	 Installation: Screw in bolts (3) only after adjustment work and tighten.	
3	Unclip left and right catch hook (arrow B) and unhook radiator grille (2)		
4	Release catch hook (4) on bracket and pivot radiator paneling (2) toward front	 Installation: Install radiator grille (2) only up to first catch tab (4)	
5	Unclip radiator grille (2) from catch hook (arrow A) and remove toward front from bumper		
6	Install in the reverse order		
	Adjust		
7	Adjust radiator grille (2)		AR88.20-P-2001EWM
8	Open engine hood, tighten bolts (3) and close engine hood		
	Check		
9	Adjust camera 360° camera with STAR DIAGNOSIS	MODEL 212 as of model year 2014 with CODE 501 (360 degree camera) without CODE 772 (AMG bodystyling) without CODE 954 (AVANTGARDE)	AD00.00-P-2000-04A
			

MODEL 212
 as of model year 2014
 with CODE 772 (AMG bodystyling)
 with CODE 954 (AVANTGARDE)

Shown with CODE 954 (AVANTGARDE)

1 Radiator grille



P88.40-3089-10

	Remove/install		
1	Remove bumper		AR88.20-P-2000EWM
2	Remove radiator grille (1)		AR88.20-P-2050EWM
3	Install in the reverse order		
	Adjust		
4	Adjust front bumper		AR88.20-P-2001EWM
	Check		
5	Adjust camera 360° camera with STAR DIAGNOSIS	MODEL 212 as of model year 2014 with CODE 501 (360 degree camera) with CODE 772 (AMG bodystyling) with CODE 954 (AVANTGARDE)	
	Connect STAR DIAGNOSIS and read out fault memory		AD00.00-P-2000-04A

MODEL 212
as of model year 2014

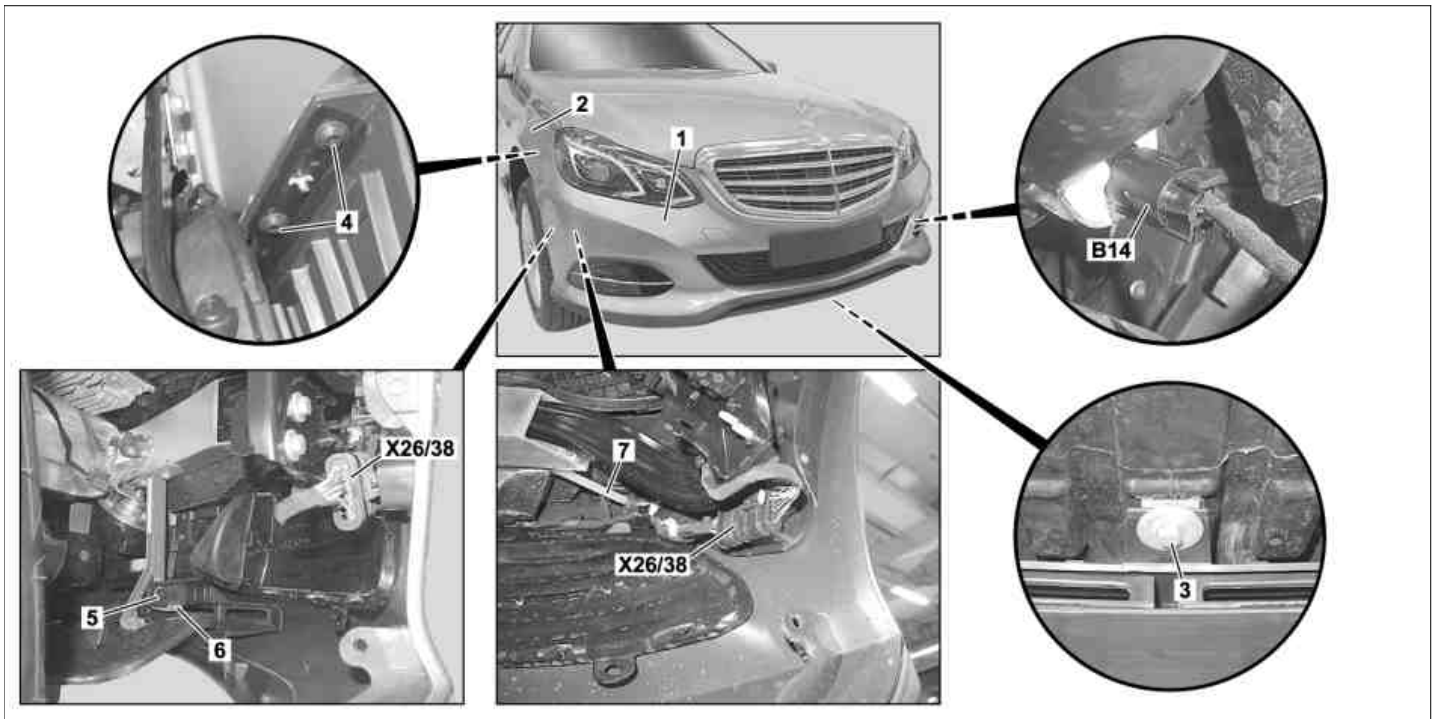

P88.20-4009-09

- | | | | |
|---|--------------|--------|--|
| 1 | Front bumper | 6 | Bracket |
| 2 | Fender | 7 | Pedestrian protection sensor |
| 3 | Screw | B14 | Outside temperature sensor |
| 4 | Bolts | X26/38 | Front bumper and frame wiring harness electrical connector |
| 5 | Screw | | |

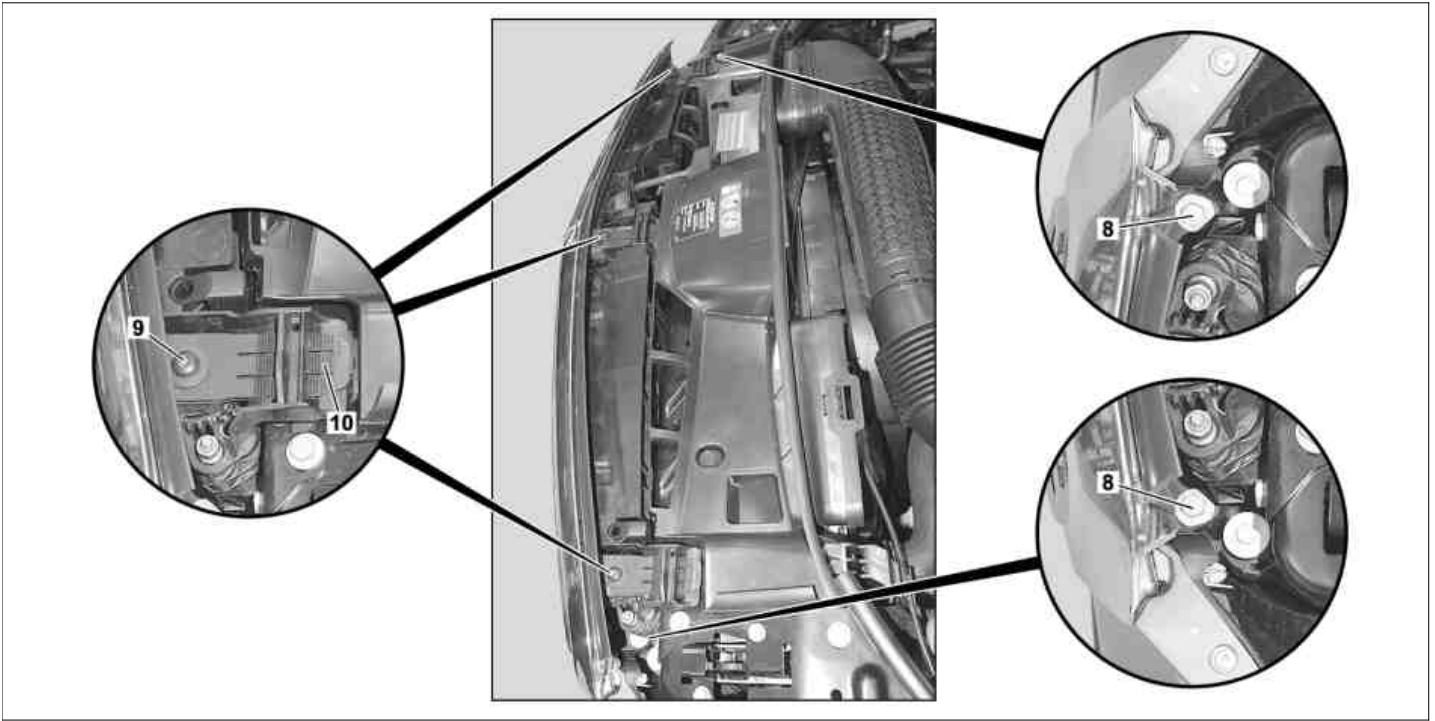

P88.20-4008-09

8 Screw
9 Screw

10 Catch lug

	Remove		
Danger !	Risk of death caused by vehicle slipping or toppling off of the lifting platform.	Align vehicle between vehicle lift columns and position the four support plates at the vehicle lift support points specified by vehicle manufacturer.	AS00.00-Z-0010-01A
1	Open engine hood		
2	Disconnect battery ground line	With CODE U60 (Pedestrian protection)	AR54.10-P-0003EW
3	Lift vehicle on vehicle lift		
4	Remove screw/bolt (3)		
5	Remove fender liner in left and right front fender	Mounting wedge	AR88.10-P-1300ELX *110589035900
6	Unscrew bolts (4) on left and right front fender (2)		
7	Unscrew bolt (5) form left and right bracket (6)		
	Check		
8	Check pedestrian protection sensor (7) on left and right	With CODE U60 (Pedestrian protection) Check freely visible points for damage of any kind (cracks, holes, breakovers, etc.) when installed. ↓ If damage is visible, always replace pedestrian sensor (7).	AR91.60-P-0950EWM
9	Disconnect electrical connector on frame wiring harness and front bumper (X2638)		
10	Unclip outside temperature sensor (B14)		

11	Remove bolts (8)	i Installation: Screw in bolts (, 8) only to stop because it may be necessary to check and adjust the gap dimensions after bumper (1) installation.	
12	Remove screw/bolts (9)	i Installation: Screw in bolts (9) only after adjustment work	
13	Push catch tabs (10) downward and toward front	i Installation: Only position catch tabs (10) in guides.	
14 i	Remove front bumper (1) General information on the impact absorber	i Installation: Check gap dimensions on front bumper (1). If gap dimensions on front bumper (1) are adjusted: Adjust front bumper (1) ↓ Gap dimension	AR88.20-P-1000-01A AR88.20-P-2001EWM AR60.00-P-0700-01EW *BE60.00-P-1006-01U
15	Disassemble front bumper (1)	Only when replacing front bumper (1)	AR88.20-P-2050EWM
16	Install in the reverse order		
17 AD	Calibrate camera 360° camera with STAR DIAGNOSIS	MODEL 212 as of model year 2014 with CODE 501 (360 degree camera)	AD00.00-P-2000-04A
18	Check whether active parking assist is ready for operation	MODEL 212 as of model year 2014 with CODE 220 (PARKTRONIC) with CODE 235 (Active Parking Assist) i Switch on ignition, switch on active parking assist, engage reverse gear and release parking brake. The active parking assist automatically performs a self-test and the operational readiness is signaled via the warning indicators.	

Check values for gap dimensions

Number	Designation				MODEL 212.0/1	MODEL 212.2
BE60.00-P-1006-01U	Gap dimension	Engine hood to headlamp	Dimension "B1"	mm	3,5 (±1)	3,5 (±1)
		Engine hood to radiator grille/bumper	Dimension "C1"	mm	3,5 (±1)	3,5 (±1)
		Offset: Engine hood to radiator grille/bumper	Dimension "C2"	mm	1 (-0,5/+1)	1 (-0,5/+1)
		Bumper to headlamp, outside	Dimension "F1"	mm	2,5 (±1,5)	2,5 (±1,5)
		Bumper to headlamp, bottom/inside	Dimension "F2"	mm	2 (-1/+1,5)	2 (-1/+1,5)
			Picture			AR60.00-P-0700-01EW

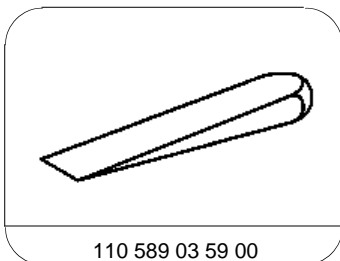

110 589 03 59 00

Mounting wedge

MODEL 207, 212, 218

Shown on model 218

- 1 Fender liner
- 2 Nuts
- 3 Expansion clips
- 4 Bolts

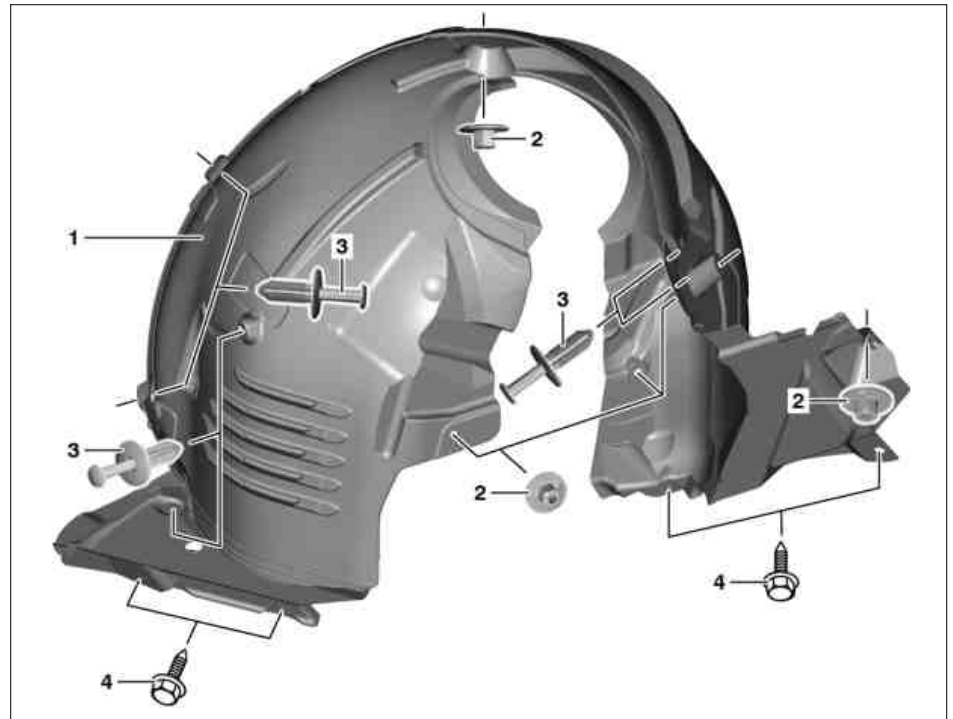

P88.10-2267-06

☒ ☒	Remove/install		
⚠ Danger !	Risk of death caused by vehicle slipping or toppling off of the lifting platform.	Align vehicle between vehicle lift columns and position the four support plates at the vehicle lift support points specified by vehicle manufacturer.	AS00.00-Z-0010-01A
1	Raise vehicle with vehicle lift		
2	Remove expansion clips (3)		
3	Remove screws/bolts (4)		
4	Unscrew nuts (2)		
5	Pull outer edge of fender liner (1) toward inside out of fender edge and remove fender liner (1) downward		
6	Install in the reverse order		

MODEL 212
as of model year 2014

Shown with CODE 954 (AVANTGARDE)

- 1 Front bumper
- 7 License plate bracket
- 8 Air grille
- 9 Chrome molding on radiator grille

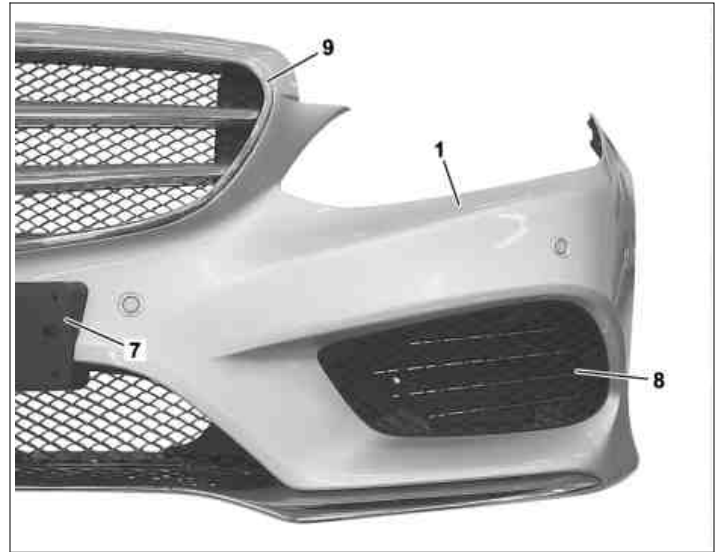

P88.20-3970-11

Shown with CODE 954 (AVANTGARDE)

- 1 Front bumper
- 2 Impact absorber
- 3 Pedestrian protection sensor
- 4 Parktronic sensors
- 5 Distronic Plus sensor
- 6 Electrical wiring harness

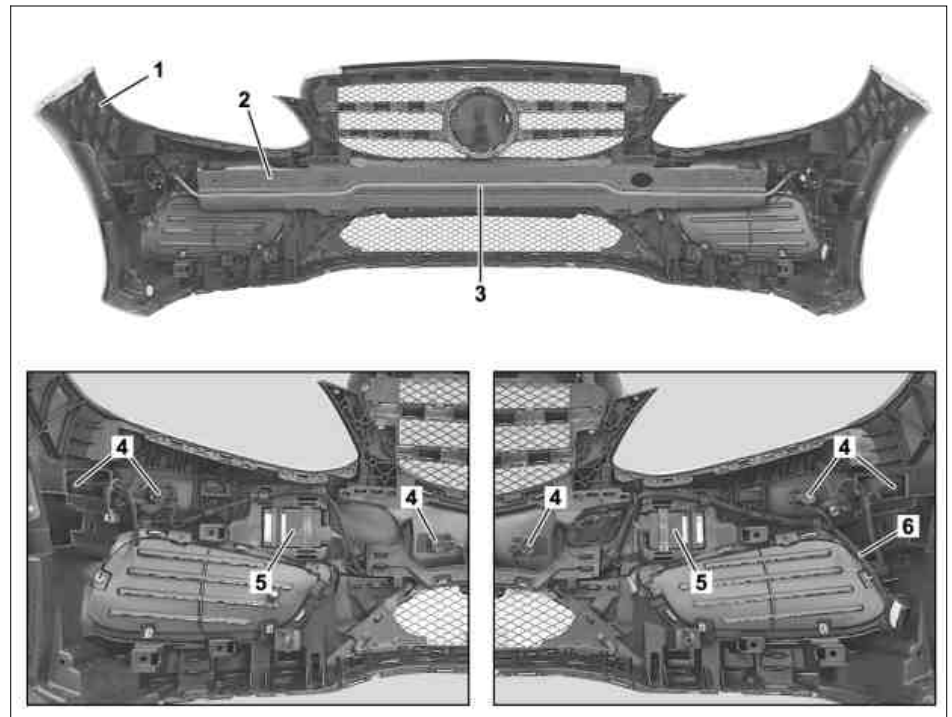

P88.20-3966-06

Shown with CODE 954 (AVANTGARDE)

- 10 Center basic carrier
- 11 Blind rivet
- 12 Lip

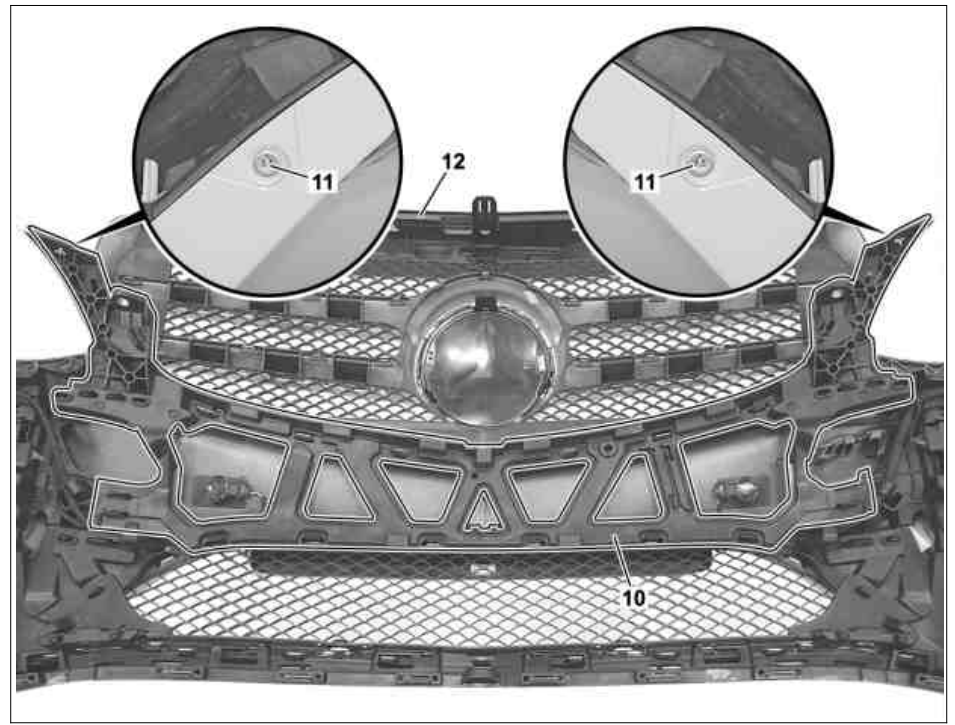

P88.20-3967-06

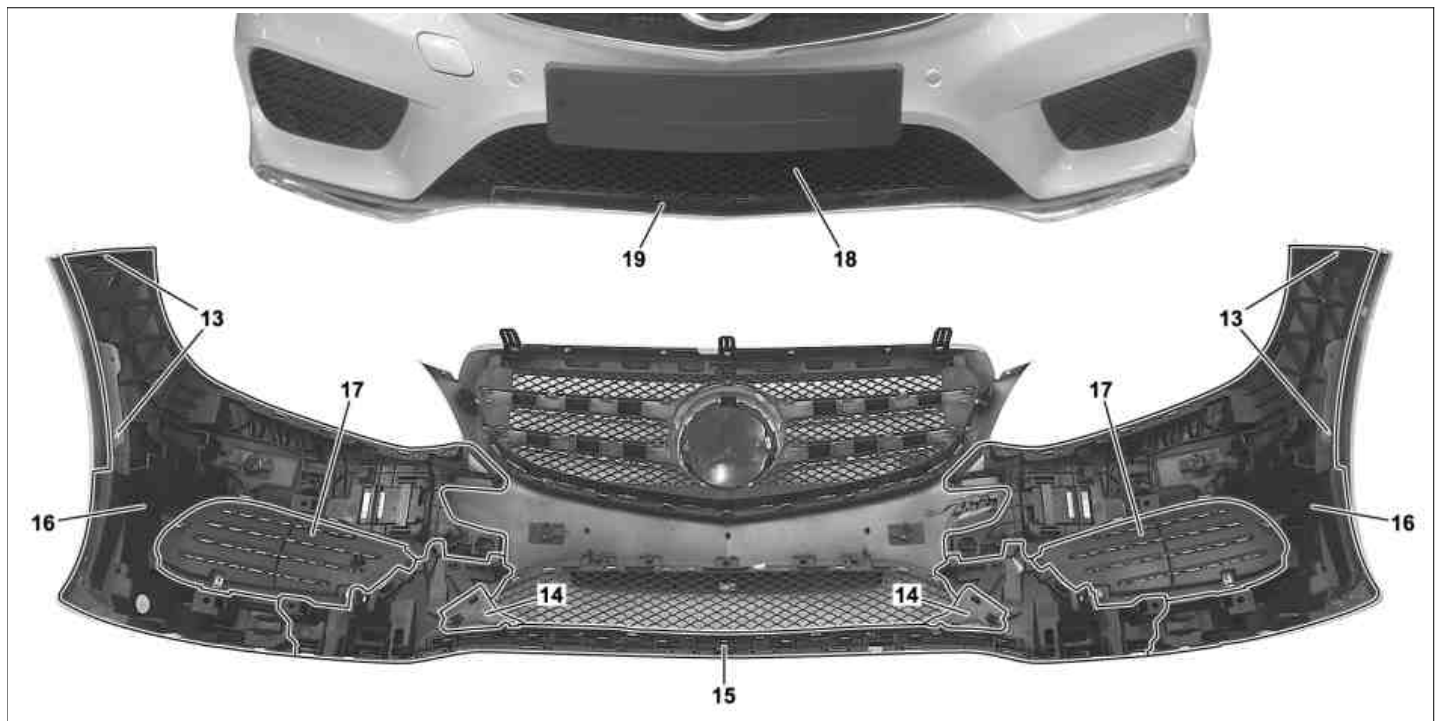

P88.20-3969-09

Shown with CODE 954 (AVANTGARDE)







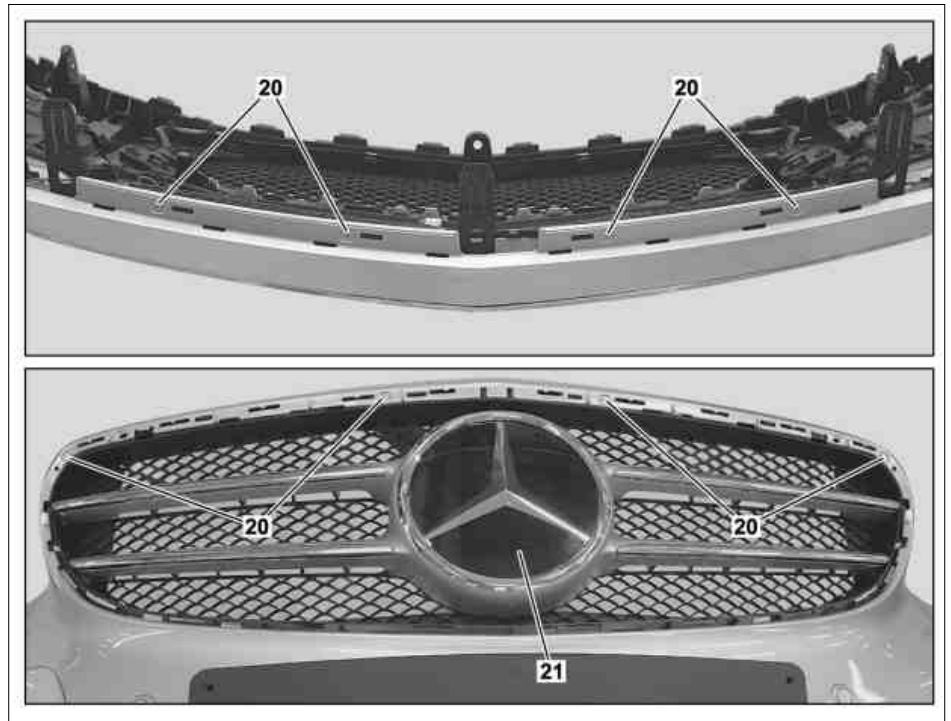





- | | |
|-------------------------|----------------------|
| 13 Pop rivets | 17 Air grille cover |
| 14 Bracket | 18 Bottom air grille |
| 15 Bottom basic carrier | 19 Bottom trim strip |
| 16 Side basic carrier | |

Shown with CODE 954 (AVANTGARDE)

- 20 Pop rivets
- 21 Radiator grille



P88.40-3082-06

 	Disassemble/assemble		
1	Remove front bumper (1)		AR88.20-P-2000EWM
2	Remove license plate bracket (7)		
3	Remove air grille (8)		
4	Remove chrome molding on radiator grille (9) from radiator grille	 Mounting wedge	*110589035900
5	Remove pedestrian protection sensors (3)	With CODE U60 (Pedestrian protection)	AR91.60-P-0950EWM
6	Remove impact absorber (2)  General information on the impact absorber		AH88.20-P-1000-01A
7	Drill out blind rivets (11) and remove center basic carrier (10)	Rechargeable screwdriver, rechargeable drill gotis://G_58.0_01.1  Mounting wedge	*110589035900
8	Remove Parktronic sensors (4) with electrical wiring harness (6)	With CODE 220 (PARKTRONIC) with CODE 230 (Exclusive parking assist)  If installed.	AR54.65-P-0001EW
9	Remove DISTRONIC Plus sensors (5) with electrical wiring harness (6)	With CODE 233 (DISTRONIC PLUS)  If installed.	
10	Drill out blind rivets (13) and remove bracket (14), bottom basic carrier (15) and side basic carrier (16)	Rechargeable screwdriver, rechargeable drill gotis://G_58.0_01.1  Mounting wedge	*110589035900
11	Remove air grille covers (17) and bottom air grille (18)	 Mounting wedge	*110589035900
12	Remove bottom trip strips (19)	 Mounting wedge	*110589035900
13	Remove sealing lip (12)		
14	Drill out blind rivets (20) and remove radiator grille (21) toward rear	Rechargeable screwdriver, rechargeable drill gotis://G_58.0_01.1  Mounting wedge	*110589035900
15	Assemble in the reverse order		
	Check		

16	Check whether PARKTRONIC or active parking assist is ready for operation	i Switch on ignition and PARKTRONIC, engage reverse gear and release parking brake. The PARKTRONIC automatically performs a self-test and the operational readiness is signaled via the warning indicators.	
----	--	--	--

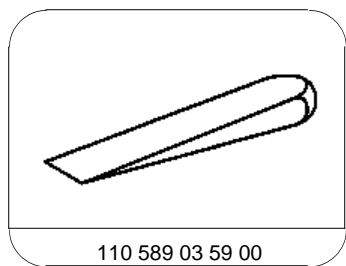

110 589 03 59 00

Mounting wedge