

- Parts list -

Vehicle	WDDHF5GB9BA292224 (D02)	E 350 Sedan	
Color	040 - SCHWARZ - UNILACK	Equipment	101 - KUNSTLEDER - SCHWARZ / ANTHRAZIT
FIN: WDD2120561A292224		Assortment class	PC
Group	72 Driver's door	Sub-group	332 Right outside mirror

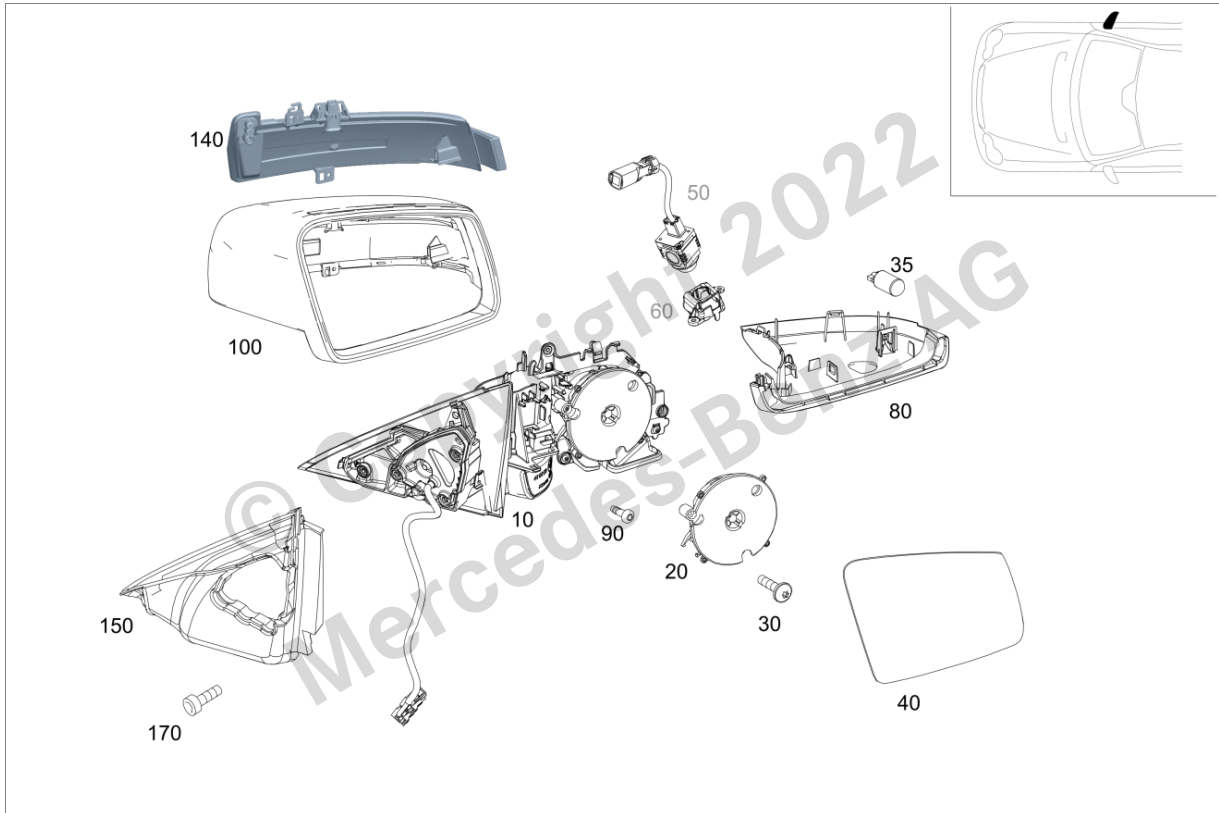













Image ID: drawing_PV000.001.428.719_version_002

Item	Part number	Designation/additional information	Qty
10	A 212 810 08 76	MIRROR FRAME ■■■ Code: 249+(494/494+(234/237))+(800/801/802/803/804)+(500/501); Replaced by: A 212 810 20 76 Replaced by: A 212 810 66 00	1
10	A 212 810 20 76	MIRROR FRAME ■■■ Code: 249+(494/494+(234/237))+(800/801/802/803/804)+(500/501); Replaced by: A 212 810 66 00 Replaces: A 212 810 08 76	1
10	A 212 810 66 00	MIRROR FRAME ■■■ Code: 249+(494/494+(234/237))+(800/801/802/803/804)+(500/501); Replaces: A 212 810 20 76 Replaces: A 212 810 08 76	1
20	A 171 820 10 42	* ELECTRIC MOTOR ■■■ Code: 275;	1
30	N 000000 002819	* HEXALOBULAR BOLT ELECTRIC MOTOR TO FRAME; 3X16	3

Parts Information

Item	Part number	Designation/additional information	Qty
35	N 000000 008140 	* BULB AMBIENT ILLUMINATION, RIGHT; 12V-5W	1
40	A 212 810 06 21 	MIRROR GLASS  Code: 460/494/835+(800/801/802/803);	1
80	A 212 810 01 15 9040 	COVER TRIM LOWER SECTION, WITH AMBIENT ILLUMINATION, RIGHT  Code: (954/955);	1
90	N 000000 002359	PAN HEAD SCREW COVER PANEL AT BOTTOM RIGHT TO MIRROR FRAME; 3X10	2
100	A 212 810 08 64 9040 	TRIM WITH INSTALLED TURN SIGNAL LAMP  Code: (800/801/802/803);	1
100	A 212 810 10 64 9999  	PARTS KIT, TRIM (PARTS KIT), TURN SIGNAL LAMP SUPPLIED LOOSE, ONLY FOR DESIGNO PAINT  [420] TO BE PAINTED PRIOR TO INSTALLATION Replaced by: A 212 810 90 00	1
100	A 212 810 90 00 9999 	PARTS KIT, COVER, HOUSING (PARTS KIT), TURN SIGNAL LAMP SUPPLIED LOOSE, ONLY FOR DESIGNO PAINT  [420] TO BE PAINTED PRIOR TO INSTALLATION Replaces: A 212 810 10 64	1
140	A 212 906 73 01	TURN SIGNAL LAMP	1
150	A 212 811 02 98	SEAL	1
170	N 000000 001935	HEXALOBULAR BOLT REARVIEW MIRROR TO DOOR; M5X16	3