

- Parts list -

Vehicle	WDDKJ7CB0BF066565 (69B)	E 500 Coupe	
Color	792 - undefined	Equipment	201 -
FIN: WDD2073721F066565		Assortment class	PC
Group	88 ATTACHMENT PARTS	Sub-group	015 FRONT FENDER

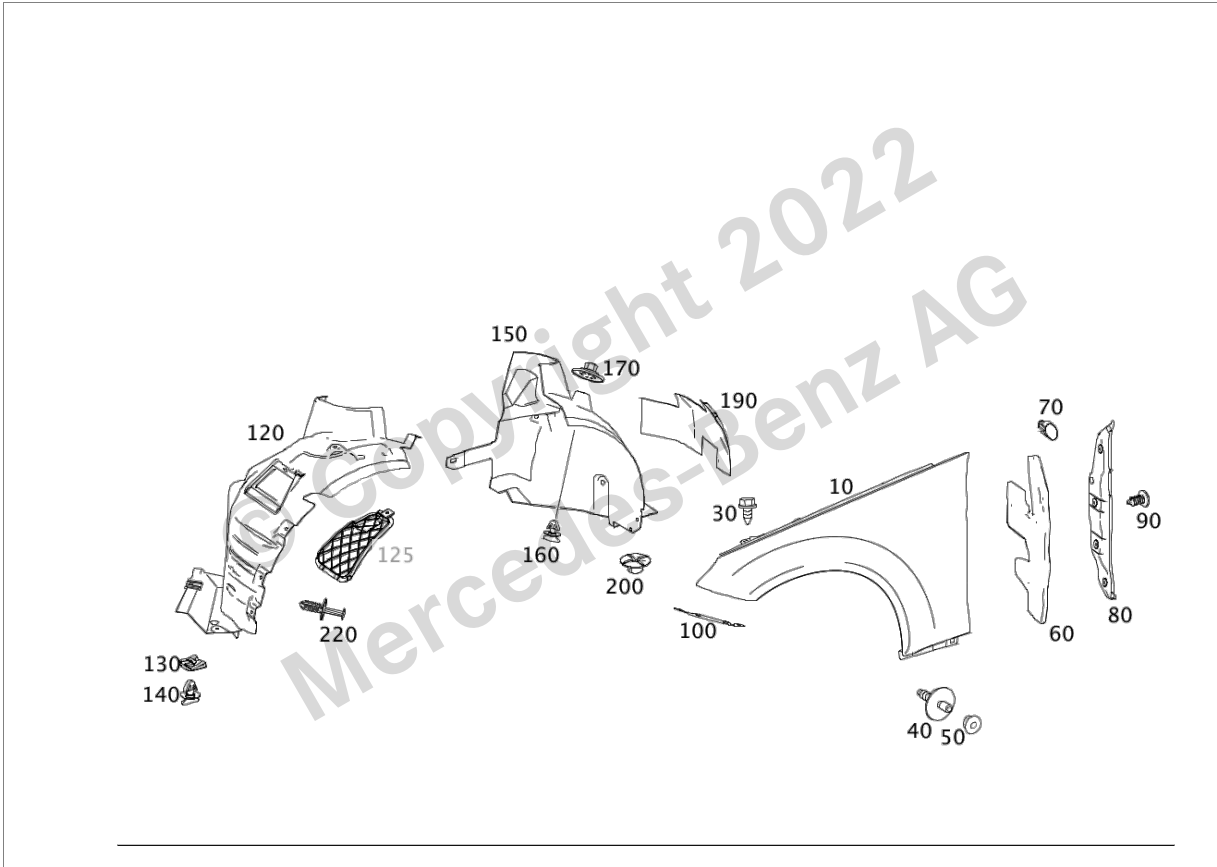















Image ID: drawing_B88015000184

Item	Part number	Designation/additional information	Qty
10	A 207 880 01 18	FENDER FRONT LEFT	1
10	A 207 880 02 18	FENDER FRONT RIGHT	1
30	A 163 990 01 36	SCREW FOR FENDER, TOP; M6X18	4
30	A 163 990 01 36	SCREW FOR FENDER, TOP; M6X18	4
40	A 001 990 15 14	STUD BOLT FOR FENDER BOTTOM	2
40	A 001 990 15 14	STUD BOLT FOR FENDER BOTTOM	2
50	A 414 990 00 51	HEXAGON NUT FOR FENDER BOTTOM; M6	2
50	A 414 990 00 51	HEXAGON NUT FOR FENDER BOTTOM; M6	2
60	A 207 885 09 37	IMPACT ABSORBER LEFT	1

Parts Information

Item	Part number	Designation/additional information	Qty
60	A 207 885 10 37	IMPACT ABSORBER RIGHT	1
70	A 207 680 05 56	SUPPORT LEFT FENDER	1
70	A 207 680 05 56	SUPPORT RIGHT FENDER	1
80	A 207 889 01 25	COVER LEFT	1
80	A 207 889 02 25	COVER RIGHT	1
90	A 002 997 33 86	COVER PLUG FOR COVERING	4
90	A 002 997 33 86	COVER PLUG FOR COVERING	4
100	A 207 889 01 95	INTERMEDIATE LAYER BETWEEN FENDER, LEFT ANDBUMPER	1
100	A 207 889 02 95	INTERMEDIATE LAYER BETWEEN FENDER, RIGHT ANDBUMPER	1
120	A 207 690 01 30 	COVER LEFT FRONT FENDER  Code: (800/801/802/803)+-M278; Replaced by: A 207 690 18 30	1
120	A 207 690 18 30 	WHEEL HOUSE COVERING LEFT FRONT FENDER  Code: (800/801/802/803)+-M278; Replaces: A 207 690 01 30	1
120	A 207 690 02 30 	COVER RIGHT FRONT FENDER  Code: (800/801/802/803); Replaced by: A 207 690 17 30	1
120	A 207 690 17 30 	COVER RIGHT FRONT FENDER  Code: (800/801/802/803); Replaces: A 207 690 02 30	1
130	A 004 994 31 45 	* CLIP NUT 4,8	2
140	A 002 988 05 42 	* LATCH	2
150	A 207 690 13 30 	COVER LEFT REAR FENDER	1
150	A 207 690 12 30 	COVER RIGHT REAR FENDER	1
160	A 002 988 05 42 	* LATCH COVERING TO COVERING	2
170	A 000 990 31 62 	* PLASTIC NUT COVER TO UNDERFLOOR PANELING	2
190	A 207 698 01 22	DAMPENING LEFT	1
190	A 207 698 02 22	DAMPENING RIGHT	1
200	A 201 990 00 50	PLASTIC NUT FRONT COVER TO SHELL	4

Parts Information

Item	Part number	Designation/additional information	Qty
200	A 201 990 00 50	PLASTIC NUT REAR COVER TO SHELL	8
220	A 124 990 04 92	EXPANSION RIVET FRONT COVER TO PANELING BUMPER; 6.5X18	8
220	A 124 990 04 92	EXPANSION RIVET COVER TO ROCKER PANEL; 6.5X18	4