

- Parts list -

|                         |  |  |
|-------------------------|--|--|
| <b>Vehicle</b>          | WDD2122011B331718 (D21)                              | E 220 BlueTEC Wagon / E 220 BlueTEC BlueEFFICIENCY Edition Wagon |
| <b>Color</b>            | 197 - undefined                                      | <b>Equipment</b> 111 -   |
| <b>Assortment class</b> | PC   | <b>Group</b> 32 Springs, suspension and hydraulic components     |
| <b>Sub-group</b>        | 154 Rear suspension strut and suspension strut mount |  |

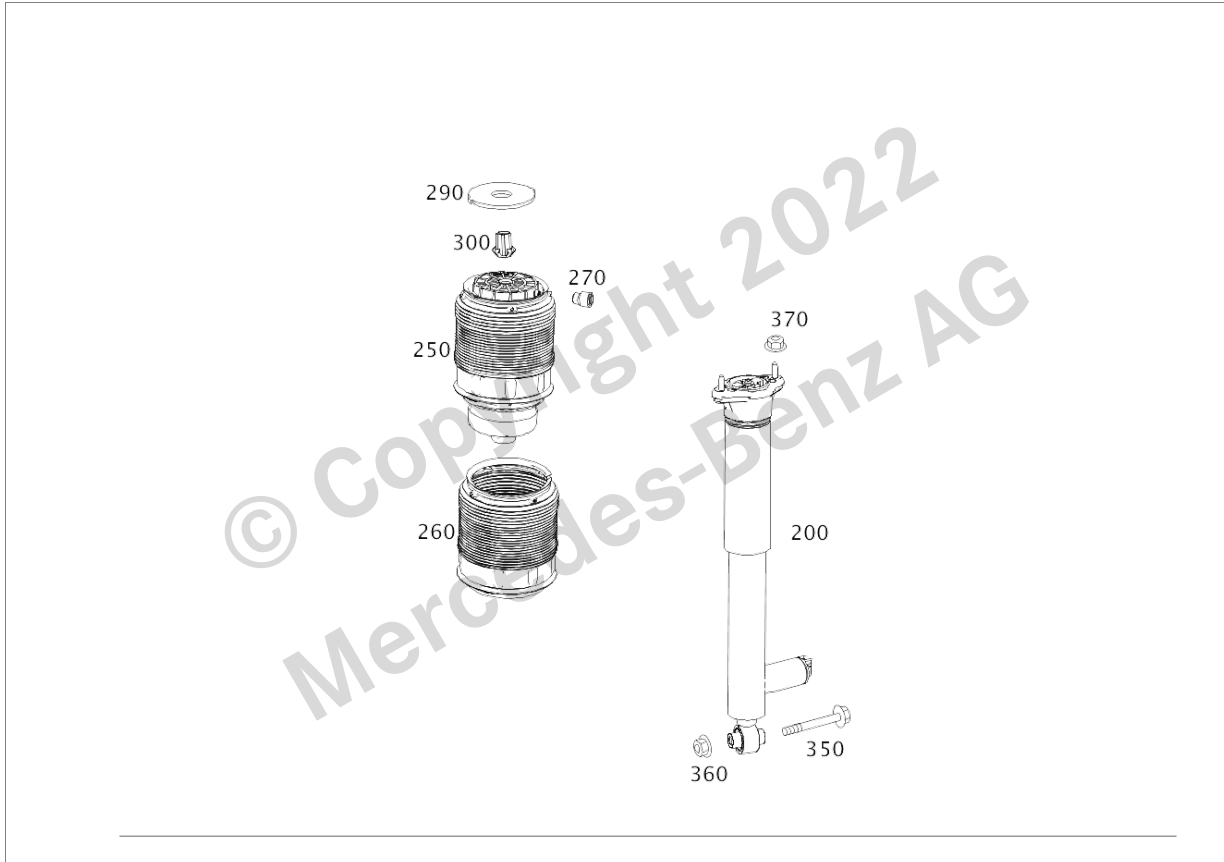













Image ID: drawing\_B32154000021

| Item | Part number  | Designation/additional information   | Qty |
|------|--|--|-----|
| 200  | A 212 320 47 30  | SHOCK ABSORBER<br>REAR LEFT AND RIGHT<br>Code: 677+(804/805/806/807);  | 2   |
| 250  | A 212 320 21 25<br> | AIR SPRING<br>REAR LEFT<br>Code: -488;<br>Replaced by: A 212 320 39 25   | 1   |
| 250  | A 212 320 39 25<br> | AIR SPRING<br>REAR LEFT<br>[002992] IMPORTANT: NOTE TIPS UP TO CHASSIS NUMBER A593462,<br>Code: -488;<br>Replaces: A 212 320 21 25 | 1   |

## Parts Information

| Item | Part number   | Designation/additional information  | Qty |
|------|---|---|-----|
| 250  | A 212 320 20 25<br>  | AIR SPRING<br>REAR RIGHT<br> Code: -488;<br>Replaced by: A 212 320 40 25   | 1   |
| 250  | A 212 320 40 25<br>  | AIR SPRING<br>REAR RIGHT<br> [002992] IMPORTANT: NOTE TIPS UP TO CHASSIS NUMBER A593462,<br> Code: -488;<br>Replaces: A 212 320 20 25 | 1   |
| 260  | A 212 327 00 92<br>  | * BOOT<br>AIR SPRING  | 2   |
| 270  | A 000 327 00 69<br>  | * CONNECTION FITTING<br>LEFT PRESSURE LINE TO AIR SPRING  | 1   |
| 270  | A 000 327 00 69<br>  | * CONNECTION FITTING<br>RIGHT PRESSURE LINE TO AIR SPRING   | 1   |
| 290  | A 212 324 00 84   | SPRING SHIM<br>TOP  | 2   |
| 300  | A 001 991 11 71   | FASTENING CLIP<br>AIR SPRING TO BODY  | 2   |
| 350  | A 000 990 20 37   | HEXALOBULAR BOLT<br>Shock absorber to spring link; M10X70   | 2   |
| 360  | N 000000 008270<br>  | NUT<br>Shock absorber to spring link; M10   | 2   |
| 360  | A 002 990 72 54<br> | HEXAGON NUT WITH FLANGE<br>Shock absorber to spring link; M10   | 2   |
| 370  | A 002 990 37 54   | HEXAGON NUT WITH FLANGE<br>Shock absorber to frame  | 4   |