

**Document number:** pe82.62-p-2300-97daa

**Document title:** Electrical function schematic for speaker system function

<b>Code:</b>	<b>Designation:</b>	<b>Position:</b>
1	Audio, signal	14G
1	Audio, signal	14C
2	Speaker illumination, actuation	6A
2	Speaker illumination, actuation	6C
3	Microphone, signal	15C
4	Speaker, actuation	17D
4	Speaker, actuation	11B
4	Speaker, actuation	10D
4	Speaker, actuation	6F
4	Speaker, actuation	4C
4	Speaker, actuation	4A
A2	Radio	7J
A2	Radio	22J
A2/56	Radio with auto pilot system	9J
A40/3	COMAND control unit	13J
A40/3	COMAND control unit	17J
A40/3	COMAND control unit	21J
B25/6	Sound system microphone	21B
Code 498	Japan version	11K
Code 505	Radio 20 NTG5, non-navigation-capable	19J
Code 510	Audio 20 with CD changer	4J
Code 511	Audio 50 APS incl. DVD changer	8J
Code 512	COMAND APS with DVD changer	11J
Code 512	COMAND APS with DVD changer	15J
Code 522	Audio 20 radio	19J
Code 523	Audio 20 radio	4K
Code 525	Audio 50 APS radio (CD)	8J
Code 526	COMAND with single DVD drive (without navigation)	15J
Code 527	COMAND APS (with navigation)	11J
Code 527	COMAND APS (with navigation)	15K
Code 528	COMAND with DVD changer	11K
Code 528	COMAND with DVD changer	15K
Code 531	COMAND APS	19K
Code 810	Sound system	12D
Code 810	Sound system	7D
Code 810	Sound system	8A
Code 810	Sound system	13A
Code 811	Extended sound system	12D
Code 811	Extended sound system	17D
Code 811	Extended sound system	5B
Code 811	Extended sound system	13B
Code 811	Extended sound system	20B
Code 811	Extended sound system	1A
Code 811	Extended sound system	12D
H4/1	Left front door speaker	5D
H4/1	Left front door speaker	19D
H4/17	Bass speaker	10B
H4/1h1	Left front door tweeter	5D
H4/2	Right front door speaker	5D
H4/2	Right front door speaker	19D
H4/23	Left front door speaker, mirror triangle	19E
H4/23	Left front door speaker, mirror triangle	7B
H4/24	Right front door speaker, mirror triangle	19E
H4/24	Right front door speaker, mirror triangle	7B
H4/27	Center instrument panel speaker	19E
H4/27	Center instrument panel speaker	9D
H4/29	Bass speaker	10B

**Document number:** pe82.62-p-2300-97daa  
**Document title:** Electrical function schematic for speaker system function

<b>Code:</b>	<b>Designation:</b>	<b>Position:</b>
H4/29	Bass speaker	2B
H4/2h1	Right front door tweeter	5E
H4/3	Left rear door speaker	5E
H4/3	Left rear door speaker	2B
H4/3h1	Left rear door tweeter	5E
H4/4	Right rear door speaker	5F
H4/4	Right rear door speaker	2B
H4/4h1	Right rear door tweeter	5F
H4/54	Left rear surround speaker	19E
H4/54	Left rear surround speaker	9D
H4/55	Right rear surround speaker	9E
H4/57	Right rear surround speaker	19F
H4/57	Right rear surround speaker	9E
H4/64	Left front door sound system bass speaker	9F
H4/64	Left front door sound system bass speaker	2B
H4/65	Right front door sound system bass speaker	9F
H4/65	Right front door sound system bass speaker	2C
H4/68	Left front door sound system tweeter	9F
H4/69	Right front door sound system tweeter	9F
H4/70	Left rear door sound system tweeter	19F
H4/70	Left rear door sound system tweeter	9G
H4/71	Right rear door sound system tweeter	19F
H4/71	Right rear door sound system tweeter	9G
H4/72	Left front door sound system midrange speaker	9G
H4/73	Right front door sound system midrange speaker	9H
H4/80	Left rear door sound system midrange speaker	9H
H4/81	Right rear door sound system midrange speaker	9H
MOST	Media Oriented System Transport	14H
N40/3	Sound system amplifier control unit	14E
N40/9	Rear bass speaker amplifier	14B
U296	Not valid for expanded sound system	4D
U500	Not valid for sound system	4D
U57	Valid for model 212.2	8D
U57	Valid for model 212.2	9B
U58	Valid for model 212.0/1	8E
U58	Valid for model 212.0/1	9A

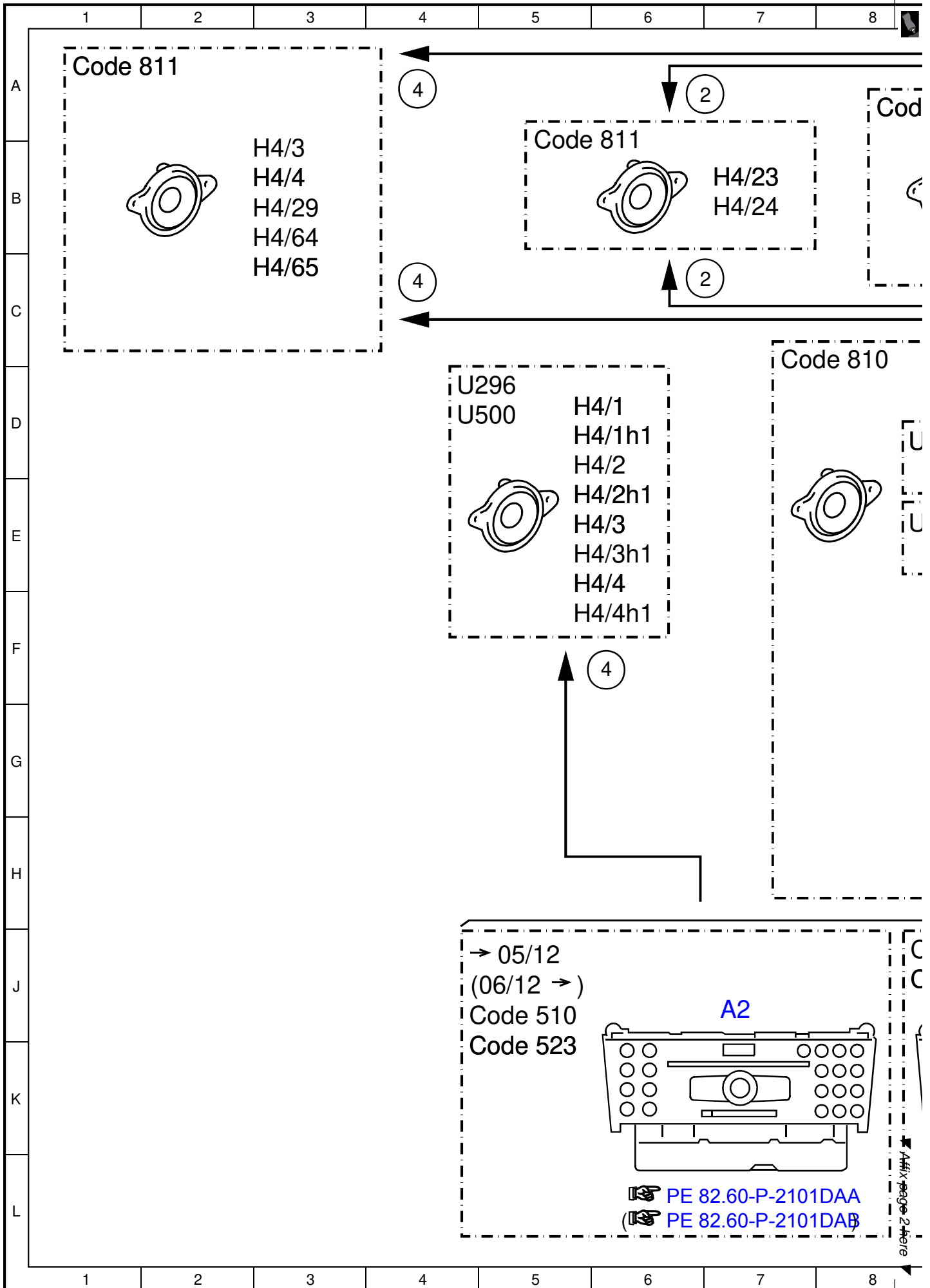

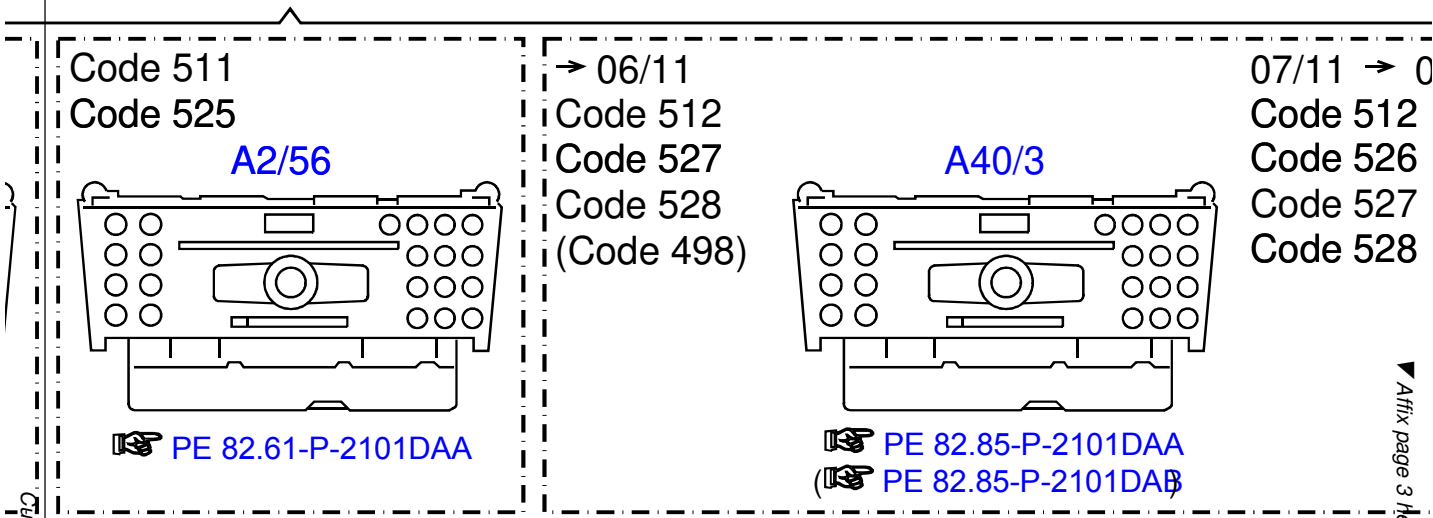
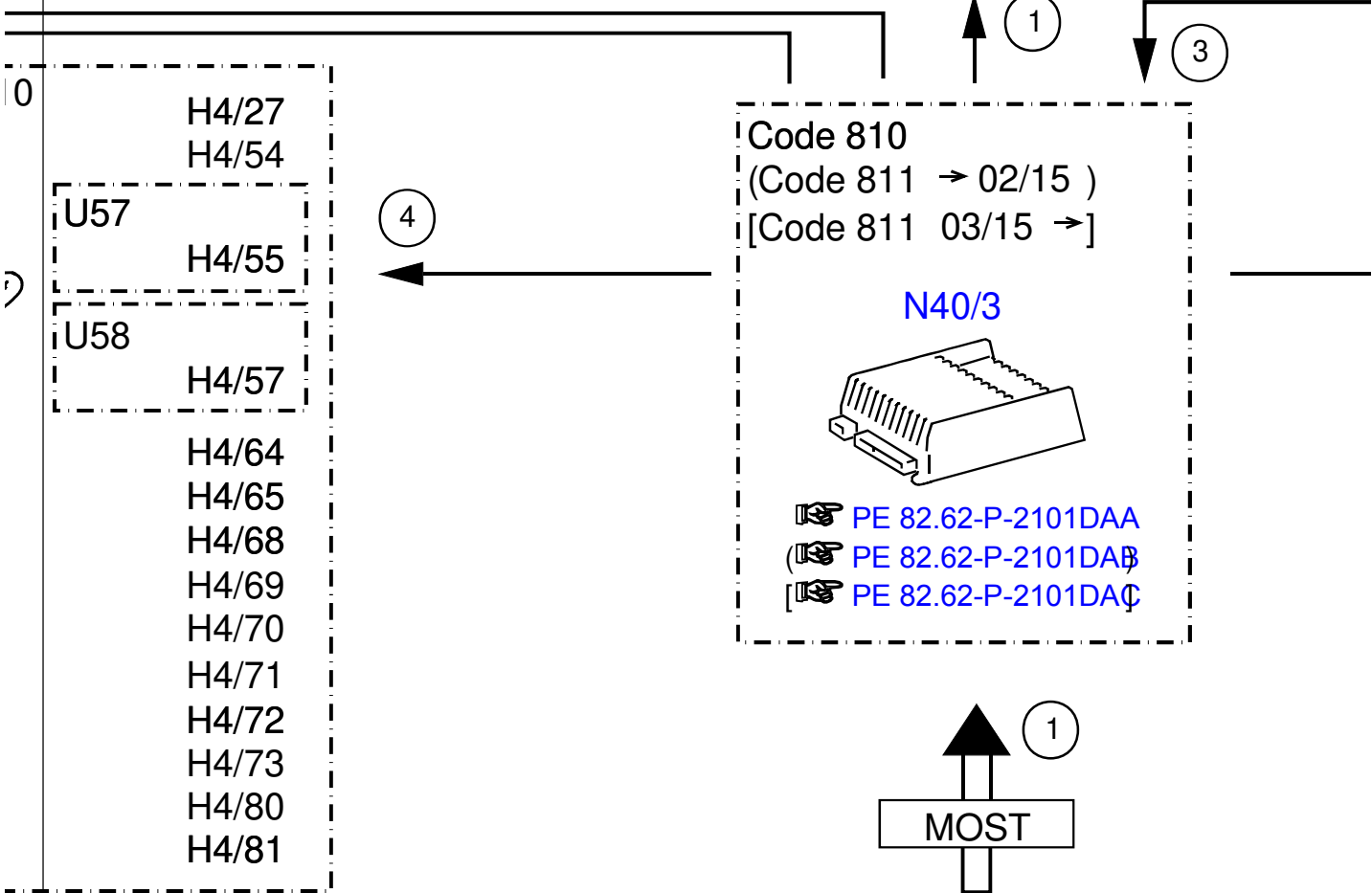
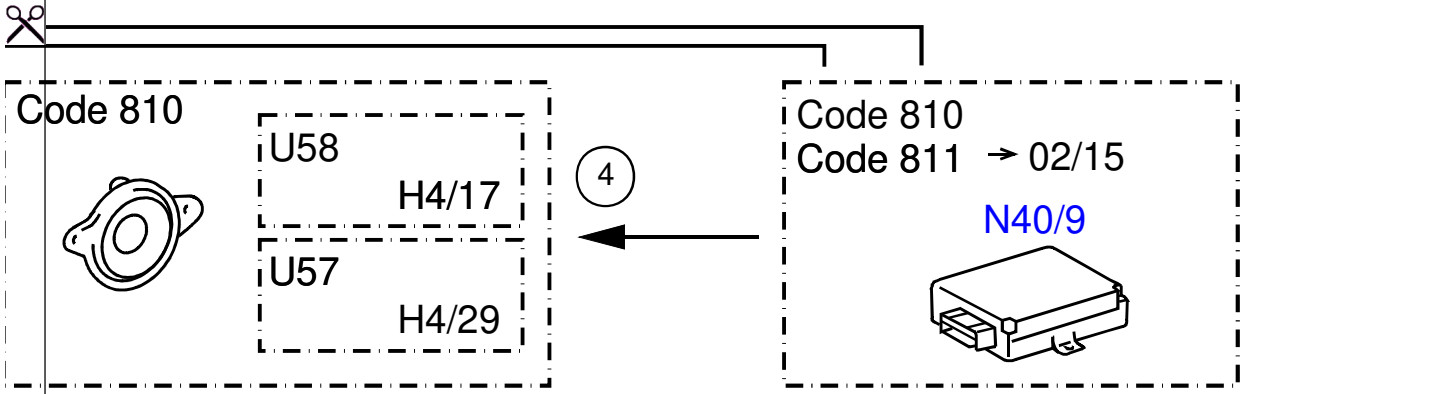

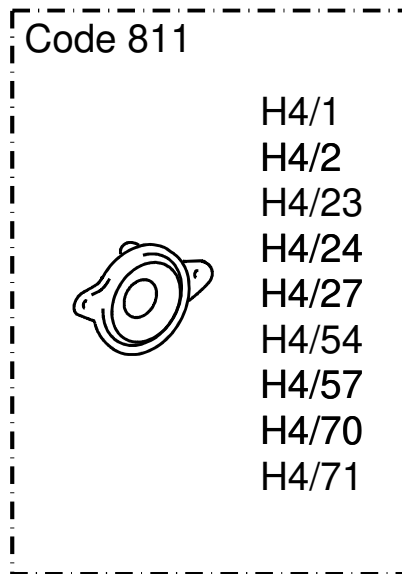
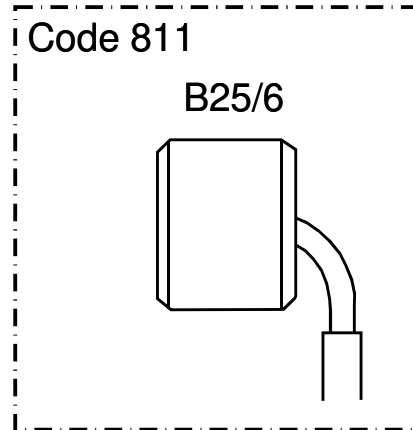

→ 02/15

512  
526  
527  
528

A40/3

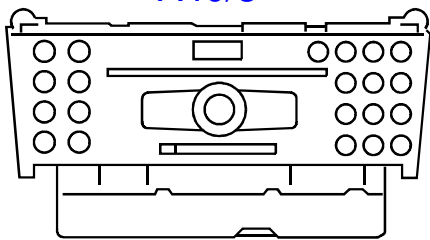

PE 82.85-P-2101DAD

03/15 →

Code 505  
Code 522  
(Code 531)

A2  
(A40/3)

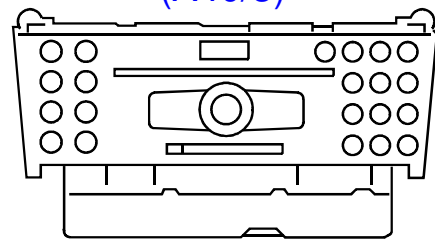

PE 82.85-P-2101DAF

Clir here

▼ Affix page 4 here

PE 82.62-P-2300-97DAF

