

- Parts list -

Vehicle	WDDHH8JB5DA728493 (D24)	E 350 4MATIC BlueEFFICIENCY Wagon
Color	149 - POLARWEISS - UNILACK	Equipment 101 - KUNSTLEDER - SCHWARZ / ANTHRAZIT
FIN: WDD2122881A728493		Assortment class PC
Group	32 Springs, suspension and hydraulic components	Sub-group 154 Rear suspension strut and suspension strut mount

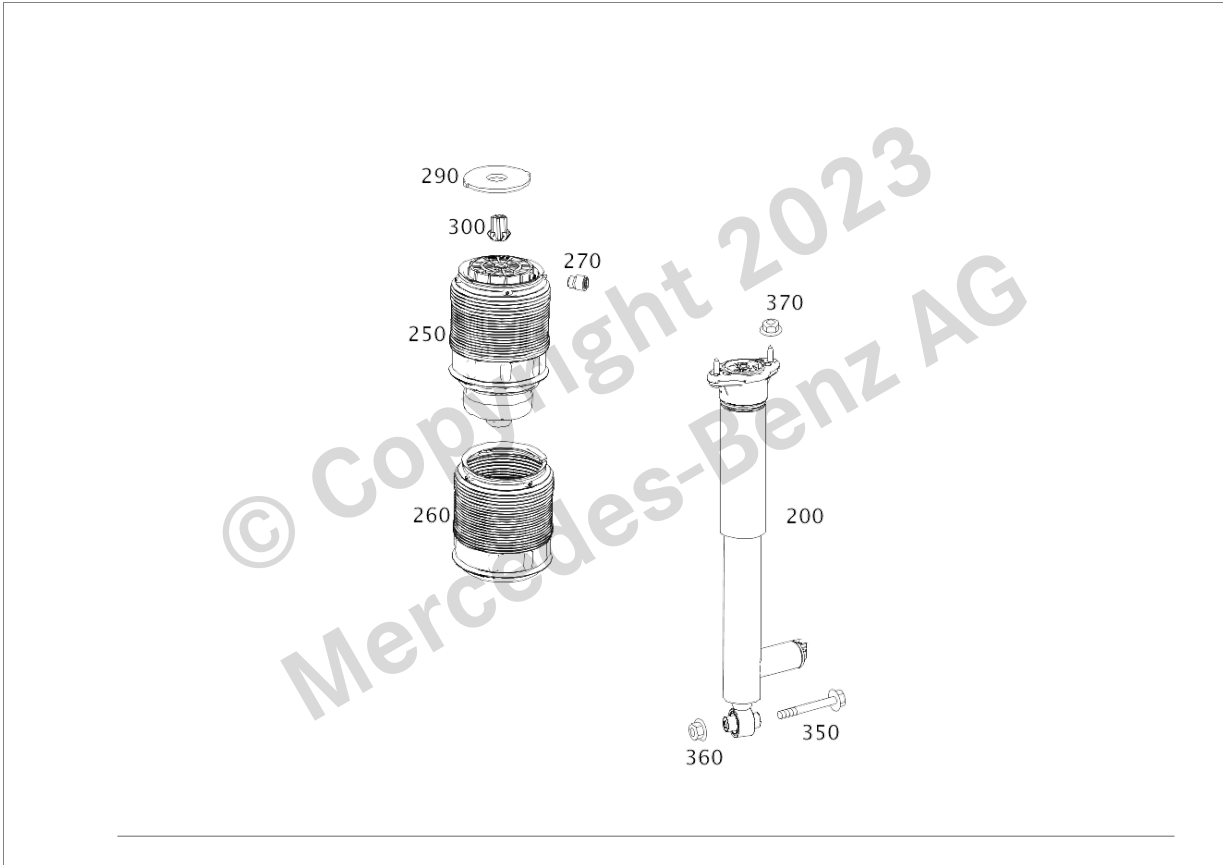













Image ID: drawing_B32154000038

Item	Part number	Designation/additional information	Qty
200	A 212 320 40 30	SHOCK ABSORBER REAR LEFT AND RIGHT Code: 677+(800/801/802/803); Replaced by: A 212 320 47 30	2
200	A 212 320 47 30	SHOCK ABSORBER REAR LEFT AND RIGHT Code: 677+(800/801/802/803); Replaces: A 212 320 40 30	2
250	A 212 320 21 25 	AIR SPRING REAR LEFT Code: -488; Replaced by: A 212 320 39 25	1

Parts Information

Item	Part number	Designation/additional information	Qty
250	A 212 320 39 25 	AIR SPRING REAR LEFT  [002992] IMPORTANT: NOTE TIPS UP TO CHASSIS NUMBER A593462,  Code: -488; Replaces: A 212 320 21 25	1
250	A 212 320 20 25 	AIR SPRING REAR RIGHT  Code: -488; Replaced by: A 212 320 40 25	1
250	A 212 320 40 25 	AIR SPRING REAR RIGHT  [002992] IMPORTANT: NOTE TIPS UP TO CHASSIS NUMBER A593462,  Code: -488; Replaces: A 212 320 20 25	1
260	A 212 327 00 92 	* BOOT AIR SPRING	2
270	A 000 327 00 69 	* CONNECTION FITTING LEFT PRESSURE LINE TO AIR SPRING	1
270	A 000 327 00 69 	* CONNECTION FITTING RIGHT PRESSURE LINE TO AIR SPRING	1
290	A 212 324 00 84	SPRING SHIM TOP	2
300	A 001 991 11 71	FASTENING CLIP AIR SPRING TO BODY	2
350	A 000 990 20 37	HEXALOBULAR BOLT Shock absorber to spring link; M10X70	2
360	N 913023 010002 	NUT Shock absorber to spring link; M10	2
360	A 002 990 72 54 	HEXAGON NUT WITH FLANGE Shock absorber to spring link; M10	2
370	A 002 990 37 54	HEXAGON NUT WITH FLANGE Shock absorber to frame	4