

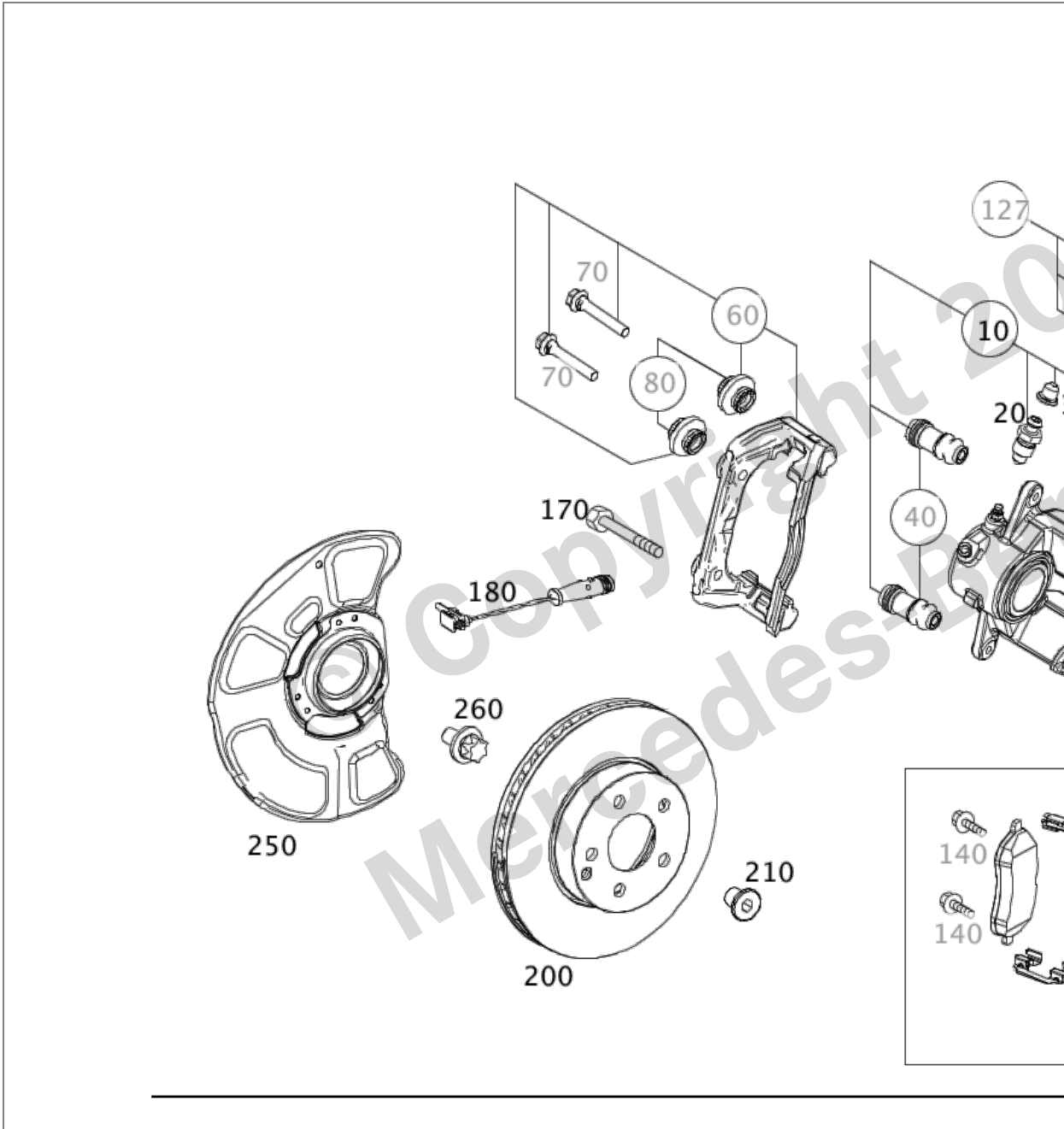















# - Parts list -











<b>Vehicle</b>	WDDHF9BBXCA545826 (D04)	E 550 4MATIC Sedan
<b>Color</b>	040 - SCHWARZ - UNILACK	<b>Equipment</b>
FIN: WDD2120911A545826		<b>Assortment class</b>
<b>Group</b>	42 Brake system	<b>Sub-group</b>





Parts Information

Item	Part number	Designation/additional information
10	A 218 421 22 98	FIXED CALIPER PARTS SET, LEFT   Code: M278+M46+M005+494;
10	A 218 421 23 98	FIXED CALIPER PARTS SET, RIGHT   Code: M278+M46+M005+494;
20	A 000 421 47 65	* PARTS KIT, BLEED VALVE WITH DUST CAP   Code: M278+M46+M005+494;
30	A 000 421 17 48	* CAP BLEEDER VALVE   Code: M278+M46+M005+494;
100	A 001 421 24 91	SPREADER SPRING   Code: M278+M46+M005+494;
115	A 000 421 59 74	* GUIDE PIN PARTS KIT   Code: M278+M46+M005+494;
130	A 006 420 16 20	PARTS KIT, BRAKEPAD PARTS KIT  [431] WHEN SELLING BRAKE LININGS TO END USERS/DESK BI HANDED OVER FREE OF CHARGE  Code: M278+M46+M005+494; <b>Replaced by: A 007 420 73 20</b>
130	A 007 420 73 20	PARTS KIT, BRAKEPAD PARTS KIT  [431] WHEN SELLING BRAKE LININGS TO END USERS/DESK BI HANDED OVER FREE OF CHARGE  Code: M278+M46+M005+494; Replaces: A 006 420 16 20

Parts Information

Item	Part number	Designation/additional information
130	A 007 420 73 20	PARTS KIT, BRAKEPAD Parts kit  [431] WHEN SELLING BRAKE LININGS TO END USERS/DESK BI HANDED OVER FREE OF CHARGE  Code: M278+M46+M005+494;
170	A 124 421 04 71	HEXAGON HEAD BOLT CALIPER TO STEERING KNUCKLE; M12X1.5 X 45  Code: -(M156+M63/M157+M55);
180	A 211 540 17 17	BRAKEPAD WEAR SENSOR BRAKE LINING WEAR INDICATOR  Code: -(M156+M63/M157+M55);
200	A 204 421 12 12	BRAKE DISK Front left  Code: M278+M46; <b>Replaced by: A 000 421 20 12</b>
200	A 000 421 20 12	BRAKE DISK, VENTED Front left  [408] ONLY REPLACEABLE BY PAIRS  Code: M278+M46; Replaces: A 204 421 12 12
200	A 204 421 12 12	BRAKE DISK Front right  Code: M278+M46; <b>Replaced by: A 000 421 20 12</b>
200	A 000 421 20 12	BRAKE DISK, VENTED Front right  [408] ONLY REPLACEABLE BY PAIRS  Code: M278+M46; Replaces: A 204 421 12 12
210	A 220 421 01 71	FIT SCREW BRAKE DISC TO WHEEL HUB; M8X12

## Parts Information

<b>Item</b>	<b>Part number</b>	<b>Designation/additional information</b>
250	A 204 421 11 20	PROTECTIVE METAL SHEET LEFT  Code: M005+-M157;
250	A 204 421 12 20	PROTECTIVE METAL SHEET RIGHT  Code: M005+-M157;
260	A 220 423 00 71	SCREW PROTECTIVE PLATE TO STEERING KNUCKLE; M6X12  Code: -(M157+M005);