

- Parts list -

Vehicle	WDDHF9HB7EA886790 (D01)	E 250 BlueTEC 4MATIC Sedan / E 250 d 4MATIC Sedan
Color	149 - undefined	Equipment 111 -
FIN: WDD2120971A886790		Assortment class PC
Group	52 Chassis sheet metal parts / air intake	Sub-group 045 Soundproofing, diesel vehicles

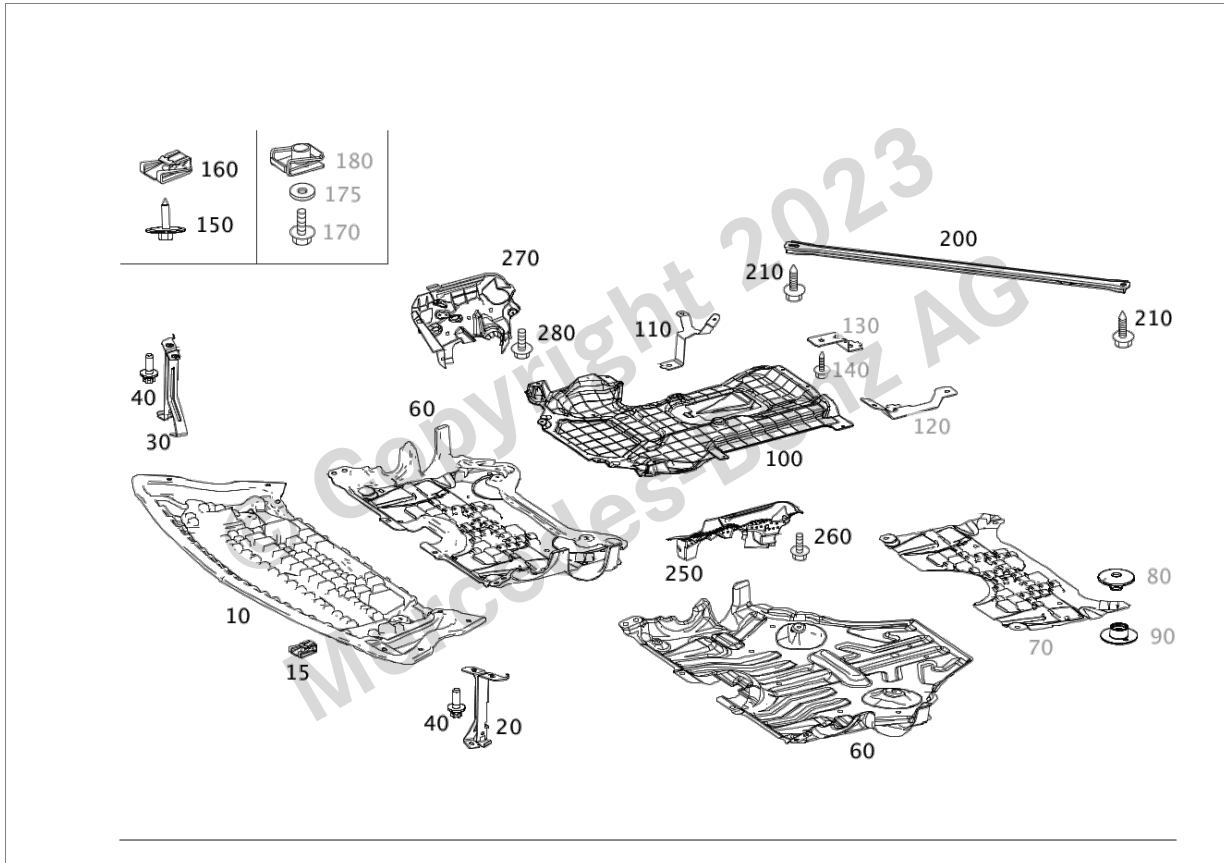





















Image ID: drawing_B52045000055

Item	Part number	Designation/additional information	Qty
10	A 212 520 54 23 	NOISE CAPSULE FRONT  Code: ((M642/M651)+M005+772)+(804/805/806/807);	1
15	A 004 994 31 45 	* CLIP-TYPE NUT FRONT PANEL AT BUMPER; 4,8  Code: M651/M642;	1
20	A 204 524 13 40	BRACKET LEFT  Code: -(M156+M63/M157);	1
30	A 204 524 14 40	BRACKET RIGHT  Code: -(M156+M63/M157);	1
40	N 910143 006002	HEXALOBULAR BOLT BRACKET LEFT AND RIGHT AT FLEXIBLE CROSSMEMBER; M6X20	4

Parts Information

Item	Part number	Designation/additional information	Qty
60	A 212 520 12 23 	NOISE CAPSULE CENTRAL  Code: M651+M005;	1
100	A 212 520 48 23	NOISE CAPSULE REAR  Code: (804+(054/072)/805/806/807)+(M651+(U42/U77)+M005);	1
110	A 212 524 20 40	BRACKET FASTENING, RIGHT REAR NOISE CAPSULE  Code: ((M651+M005+427+U42+(494/460))+(804/805/806/807))+450;	1
150	A 001 990 60 36	SHEET METAL SCREW FRONT TRIM TO BRACKET; 4.8X19	2
150	A 001 990 60 36	SHEET METAL SCREW FRONT TRIM TO FRAME-TYPE INTEGRALSUPPORT; 4.8X19	2
150	A 001 990 60 36	SHEET METAL SCREW PANELING FRONT TO WHEELHOUSE PANEL; 4.8X19	4
150	A 001 990 60 36	SHEET METAL SCREW FRONT PANEL AT BUMPER; 4.8X19  Code: M651/M642;	1
150	A 001 990 60 36	SHEET METAL SCREW CENTRAL COVERING TO FRAME-TYPE INTEGRAL SUPPORT; 4.8X19  Code: -481;	4
150	A 001 990 60 36	SHEET METAL SCREW FASTENING, CENTER PANELING; 4.8X19  Code: M005+-481;	4
150	A 001 990 60 36	SHEET METAL SCREW ATTACHMENT OF LINING,REAR; 4.8X19  Code: (M642/M651)+M005;	7
150	A 001 990 60 36	SHEET METAL SCREW FASTENING, REAR COVER AT WHEEL ARCH; 4.8X19	2
160	A 004 994 31 45	CLIP-TYPE NUT FRONT TRIM TO BRACKET; 4,8	2
160	A 004 994 31 45	CLIP-TYPE NUT FRONT TRIM TO FRAME-TYPE INTEGRALSUPPORT; 4,8	2
160	A 004 994 31 45	CLIP-TYPE NUT CENTRAL COVERING TO FRAME-TYPE INTEGRAL SUPPORT; 4,8  Code: -481;	4
160	A 004 994 31 45	CLIP-TYPE NUT FASTENING, CENTER PANELING; 4,8  Code: M005+-481;	4
160	A 004 994 31 45	CLIP-TYPE NUT ATTACHMENT OF LINING,REAR; 4,8  Code: M642/(M642/M651)+M005;	3
160	A 001 994 98 45	CLIP-TYPE NUT FASTENING, REAR PANELING AT LONGITUDINAL MEMBER  Code: M651;	4
200	A 204 524 05 47	STRUT FRONT LEFT  Code: M005;	1
200	A 204 524 05 47	STRUT FRONT RIGHT  Code: M005;	1

Parts Information

Item	Part number	Designation/additional information	Qty
210	A 004 990 45 00	HEXAGON HEAD BOLT STRUT HOLDER LEFT AND RIGHT; M10X23,5  Code: M005;	4
250	A 212 524 10 25 	NOISE CAPSULE CENTRAL LEFT  Code: M642+-M005/M651;	1
260	A 000 990 16 17	SCREW LEFT CENTER NOISE CAPSULE AT FRAME-TYPE INTEGRAL SUPPORT; M6X12  Code: (M642/M278)+-M005/M651;	2
270	A 212 524 15 25 	NOISE CAPSULE CENTRAL RIGHT  Code: M642+-M005/M651;	1
280	A 000 990 16 17	SCREW RIGHT CENTER NOISE CAPSULE AT FRAME-TYPE INTEGRAL SUPPORT; M6X12  Code: M274/M276+006/M651;	2